

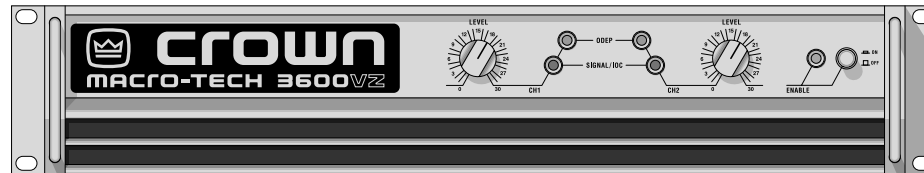

Macro-Tech Series

Operation Manual



MA-3600VZ

Obtaining Other Language Versions: To obtain information in another language about the use of this product, please contact your local Crown Distributor. If you need assistance locating your local distributor, please contact Crown at 574-294-8000.

This manual does not include all of the details of design, production, or variations of the equipment. Nor does it cover every possible situation which may arise during installation, operation or maintenance.

Note: The information provided in this manual was deemed accurate as of the publication date. However, updates to this information may have occurred. To obtain the latest version of this manual, please visit the Crown website at www.crownaudio.com.

Trademark Notice: PIP and IQwic are trademarks, and Amcron, Crown, Crown Audio, Macro-Tech, IOC, IQ System, VZ and ODEP are registered trademarks of Crown International. Other trademarks are the property of their respective owners.

Some models may be exported under the name Amcron.®

©2006 by Crown Audio® , Inc. 1718 W. Mishawaka Rd., Elkhart, Indiana 46517-9439 U.S.A. Telephone: 574-294-8000

H A Harman International Company

125113-9
12/06

Important Safety Instructions

Importantes Instrucciones de Seguridad

- 1) Read these instructions.
- 2) Keep these instructions.
- 3) Heed all warnings.
- 4) Follow all instructions.
- 5) Do not use this apparatus near water.
- 6) Clean only with a dry cloth.
- 7) Do not block any ventilation openings. Install in accordance with the manufacturer's instructions.
- 8) Do not install near any heat sources such as radiators, heat registers, stoves, or other apparatus (including amplifiers) that produce heat.
- 9) Do not defeat the safety purpose of the polarized or grounding-type plug. A polarized plug has two blades with one wider than the other. A grounding-type plug has two blades and a third grounding prong. The wide blade or the third prong is provided for your safety. If the provided plug does not fit into your outlet, consult an electrician for replacement of the obsolete outlet.
- 10) Protect the power cord from being walked on or pinched, particularly at plugs, convenience receptacles, and the point where they exit from the apparatus.
- 11) Only use attachments/accessories specified by the manufacturer.
- 12) Use only with a cart, stand, tripod, bracket, or table specified by the manufacturer, or sold with the apparatus. When a cart is used, use caution when moving the cart/apparatus combination to avoid injury from tip-over.
- 13) Unplug this apparatus during lightning storms or when unused for long periods of time.
- 14) Refer all servicing to qualified service personnel. Servicing is required when the apparatus has been damaged in any way, such as power-supply cord or plug is damaged, liquid has been spilled or objects have fallen into the apparatus, the apparatus has been exposed to rain or moisture, does not operate normally, or has been dropped.
- 15) Use the mains plug to disconnect the apparatus from the mains.
- 16) **WARNING: TO REDUCE THE RISK OF FIRE OR ELECTRIC SHOCK, DO NOT EXPOSE THIS APPARATUS TO RAIN OR MOISTURE.**
- 17) **DO NOT EXPOSE THIS EQUIPMENT TO DRIPPING OR SPLASHING AND ENSURE THAT NO OBJECTS FILLED WITH LIQUIDS, SUCH AS VASES, ARE PLACED ON THE EQUIPMENT.**
- 18) **THE MAINS PLUG OF THE POWER SUPPLY CORD SHALL REMAIN READILY OPERABLE.**



Wichtige Sicherheitsinstruktionen

Instrucciones de Seguridad Importantes

TO PREVENT ELECTRIC SHOCK DO NOT REMOVE TOP OR BOTTOM COVERS. NO USER SERVICEABLE PARTS INSIDE. REFER SERVICING TO QUALIFIED SERVICE PERSONNEL.

À PRÉVENIR LE CHOC ÉLECTRIQUE N'ENLEVEZ PAS LES COUVERCLES. IL N'Y A PAS DES PARTIES SERVICEABLE À L'INTÉRIEUR. TOUTS RÉPARATIONS DOIT ÊTRE FAIRE PAR PERSONNEL QUALIFIÉ SEULMENT.

PARA PREVENIR UN CHOQUE ELÉCTRICO, NO RETIRE LAS CUBIERTAS SUPERIOR O INFERIOR. NO EXISTEN PARTES QUE PUEDAN SER REPARADAS POR EL USUARIO AL INTERIOR. REMITA EL SERVICIO AL PERSONAL TÉCNICO CALIFICADO.

TO COMPLETELY DISCONNECT THIS EQUIPMENT FROM THE AC MAINS, DISCONNECT THE POWER SUPPLY CORD PLUG FROM THE AC RECEPTACLE. THE MAINS PLUG OF THE POWER SUPPLY CORD SHALL REMAIN READILY OPERABLE.

POUR DÉMONTER COMPLÈTEMENT L'ÉQUIPEMENT DE L'ALIMENTATION GÉNÉRALE, DÉMONTER LE CÂBLE D'ALIMENTATION RESTERA AISÉMENT FONCTIONNELLE.

PARA DESCONECTAR COMPLETAMENTE EL EQUIPO DEL SUMINISTRO ELÉCTRICO, DESCONECTE EL CABLE DE ALIMENTACION DE LA TOMA DE CA. LAS PATAS DEL CONECTOR DEL CABLE DE ALIMENTACIÓN DEBERAN MANTENERSE EN BUEN ESTADO.

WATCH FOR THESE SYMBOLS:

The lightning bolt triangle is used to alert the user to the risk of electric shock.

The exclamation point triangle is used to alert the user to important operating or maintenance instructions.

REGARDEZ CES SYMBOLES

La triangle avec le sigle "foudre" est employée pour alerter l'utilisateur au risque de décharge électrique. Le triangle avec un point d'exclamation est employée pour alerter l'utilisateur d'instruction importantes pour lors opérations de maintenance.

ATENCION CON ESTOS SÍMBOLOS

El triángulo con el símbolo de rayo eléctrico es usado para alertar al usuario de el riesgo de un choque eléctrico.

El triángulo con el signo de admiración es usado para alertar al usuario de instrucciones importantes de operación o mantenimiento.



CAUTION
RISK OF ELECTRIC SHOCK
DO NOT OPEN

AVIS
RISQUE DE CHOC ÉLECTRIQUE
N'OUVREZ PAS



IMPORTANT

Macro-Tech 3600VZ requires Class 1 output wiring. Macro-Tech 3600VZ exige des câbles de sortie de classe 1. Macro-Tech 3600VZ erfordert Klasse die 1 Produktionsverdrahtung. Macro-Tech 3600VZ requiere de un cableado de salida Clase 1.

MAGNETIC FIELD

CAUTION! Do not locate sensitive high-gain equipment such as preamplifiers or tape decks directly above or below the unit. Because this amplifier has a high power density, it has a strong magnetic field which can induce hum into unshielded devices that are located nearby. The field is strongest just above and below the unit.

If an equipment rack is used, we recommend locating the amplifier(s) in the bottom of the rack and the preamplifier or other sensitive equipment at the top.

FCC COMPLIANCE NOTICE

This device complies with part 15 of the FCC rules. Operation is subject to the following two conditions: (1) This device may not cause harmful interference, and (2) this device must accept any interference received, including interference that may cause undesired operation.

CAUTION: Changes or modifications not expressly approved by the party responsible for compliance could void the user's authority to operate the equipment.

NOTE: This equipment has been tested and found to comply with the limits for a Class B digital device, pursuant to part 15 of the FCC Rules. These limits are designed to provide reasonable protection against harmful interference in a residential installation. This equipment generates, uses, and can radiate radio frequency energy and, if not installed and used in accordance with the instruction manual, may cause harmful interference to radio communications. However, there is no guarantee that interference will not occur in a particular installation. If this equipment does cause harmful interference to radio or television reception, which can be determined by turning the equipment off and on, the user is encouraged to try to correct the interference by one or more of the following measures:

- Reorient or relocate the receiving antenna.
- Increase the separation between the equipment and receiver.
- Connect the equipment into an outlet on a circuit different from that to which the receiver is connected.
- Consult the dealer or an experienced radio/TV technician for help.

Crown International, Inc.

DECLARATION of CONFORMITY

TCF Technical Certificate No: P4300CRI1.IWS

Technical Construction File Route

Issued By: Crown International, Inc.
1718 W. Mishawaka Road
Elkhart, Indiana 46517 U.S.A.

FOR COMPLIANCE QUESTIONS ONLY: Sue Whitfield
574-294-8289
swhitfield@crowintl.com

Competent Body's Name and Address:

Technology International (Europe) Limited
41-42 Shrivenham Hundred Business Park,
Shrivenham, Swindon, Wilts, SN6 8TZ

European Representative's Name and Address:

Nick Owen
35, Bassets Field
Thornhill
Cardiff, South Glamorgan
CF14 9UG United Kingdom

Equipment Type: Commercial Audio Power Amplifier**Family Name:** Macro-Tech Series**Model Names:** Macro-Tech 3600VZ**EMC Standards:****EN 55103-1:1995** Electromagnetic Compatibility - Product Family Standard for Audio, Video, Audio-Visual and Entertainment Lighting Control Apparatus for Professional Use, Part 1: Emissions**EN 55103-1:1995** Magnetic Field Emissions-Annex A @ 10 cm and 1 M**EN 61000-3-2:1995+A14:2000** Limits for Harmonic Current Emissions (equipment input current $\leq 16A$ per phase)**EN 61000-3-3:1995** Limitation of Voltage Fluctuations and Flicker in Low-Voltage Supply Systems Rated Current $\leq 16A$ **EN 55022:1992 + A1: 1995 & A2:1997** Limits and Methods of Measurement of Radio Disturbance Characteristics of ITE: Radiated, Class B Limits; Conducted, Class B**EN 55103-2:1996** Electromagnetic Compatibility - Product Family Standard for Audio, Video, Audio-Visual and Entertainment Lighting Control Apparatus for Professional Use, Part 2: Immunity**EN 61000-4-2:1995** Electrostatic Discharge Immunity (Environment E2-Criteria B, 4k V Contact, 8k V Air Discharge)**EN 61000-4-3:1996** Radiated, Radio-Frequency, Electromagnetic Immunity (Environment E2, criteria A)**EN 61000-4-4:1995** Electrical Fast Transient/Burst Immunity (Criteria B)**EN 61000-4-5:1995** Surge Immunity (Criteria B)**EN 61000-4-6:1996** Immunity to Conducted Disturbances Induced by Radio-Frequency Fields (Criteria A)**EN 61000-4-11:1994** Voltage Dips, Short Interruptions and Voltage Variation**Safety Standard:****EN 60065: 1998** Safety Requirements - Audio Video and Similar Electronic Apparatus

I certify that the product identified above conforms to the requirements of the EMC Council Directive 89/336/EEC as amended by 92/31/EEC, and the Low Voltage Directive 73/23/EES as amended by 93/68/EEC.

Signed

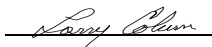

Larry Coburn

Title: Senior Vice President of Manufacturing

Date of Issue: March 28, 2000

Table of Contents

Important Safety Instructions	2		
Declaration of Conformity	3		
1 Welcome	5		
1.1 Features	5		
2 How to Use This Manual	5		
3 Setup	6		
3.1 Unpack Your Amplifier	6		
3.2 Install Your Amplifier	6		
3.3 Ensure Proper Cooling	6		
3.4 Choose Input Wire and Connectors	7		
3.5 Choose Output Wire and Connectors	8		
3.6 Wire Your System	9		
3.6.1 Stereo Mode	9		
3.6.2 Bridge-Mono Mode	9		
3.6.3 Parallel-Mono Mode	10		
3.7 Connect to AC Mains	11		
3.8 Startup Procedure	11		
4 Operation	11		
4.1 Precautions	11		
4.2 Front Panel Controls and Indicators	12		
4.3 Back Panel Controls and Connectors	13		
		5 Advanced Features and Options	14
		5.1 Protection Systems	14
		5.1.1 Output Device Emulation Protection (ODEP)	14
		5.1.2 IOC (Input Output Comparator)	14
		5.2 Circuit Designs	14
		5.2.1 Grounded Bridge	14
		5.2.2 Variable Impedance (VZ)	14
		5.3 Options	15
		5.3.1 IQ-PIP-USP2 Adapter and PIP-Lite Module	15
		5.3.2 Input Sensitivity Switch	15
		5.3.3 Input Ground Lift Switch	15
		6 Specifications	16
		7 Troubleshooting	20
		8 Service	21
		8.1 Worldwide Service	21
		8.2 US and Canada Service	21
		8.2.1 Service at a US or Canada Service Center.....	21
		8.2.2 Factory Service	21
		8.2.3 Factory Service Shipping Instructions	21
		9 Warranty	22
		Crown Factory Service Information Form	25

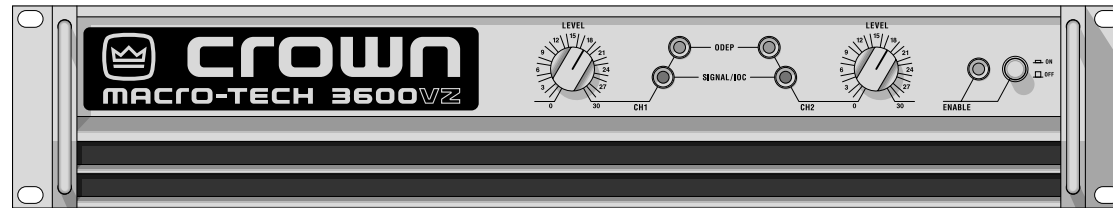

MA-3600VZ

*1 kHz Power

2 ohm Dual (per ch.)	1,800W
4 ohm Dual (per ch.)	1,565W
8 ohm Dual (per ch.)	1,120W
4 ohm Bridge-Mono	3,505W
8 ohm Bridge-Mono	3,140W

*1 kHz Power: refers to maximum average power in watts at 1 kHz with 0.1% THD.

1 Welcome

The Crown® *Macro-Tech*® 3600VZ professional power amplifier features Crown's patented *Variable Impedance (VZ)*® power supply. This power supply, along with advanced semiconductor technology, enables the Macro-Tech 3600VZ to pack more power into a mere 3½ inches of vertical rack space than ever before. Because it's a Macro-Tech, you have the added benefit of *PIP*™ compatibility for access to custom input modules and *ODEP*® protection to keep the show going long after other amplifiers would fail.

Modern power amplifiers are sophisticated pieces of engineering capable of producing extremely high power levels. They must be treated with respect and correctly installed if they are to provide the many years of reliable service for which they were designed.

In addition, the MA-3600VZ amplifier includes a number of features which require some explanation before they can be used to their maximum advantage.

Please take the time to study this manual so that you can obtain the best possible service from your amplifier.

1.1 Features

- Grounded Bridge design delivers large voltage swings without stressing output-transistors, resulting in lower distortion and superior reliability.
- Patented ODEP (Output Device Emulation Protection) circuitry compensates for overheating and overload to keep the amplifier working when others would fail.
- IOC® (Input/Output Comparator) circuitry immediately alerts of any distortion exceeding 0.05%, providing dynamic proof of distortion-free performance.
- Articulated VZ power supplies for each channel provide excellent crosstalk characteristics and the best power matching to your load.

2 How to Use This Manual

This manual provides you with the necessary information to safely and correctly setup and operate your amplifier. It does not cover every aspect of installation, setup or operation that might occur under every condition. For additional information, please consult Crown's *Amplifier Application Guide* (available online at www.crownaudio.com), Crown Tech Support, your system installer or retailer.

We strongly recommend you read all instructions, warnings and cautions contained in this manual. Also, for your protection, please send in your warranty registration card today. And save your bill of sale—it's your official proof of purchase.

3 Setup

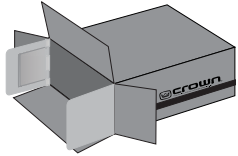

3.1 Unpack Your Amplifier

Please unpack and inspect your amplifier for any damage that may have occurred during transit. If damage is found, notify the transportation company immediately. Only you can initiate a claim for shipping damage. Crown will be happy to help as needed. Save the shipping carton as evidence of damage for the shipper's inspection.

We also recommend that you save all packing materials so you will have them if you ever need to transport the unit. Never ship the unit without the factory pack. YOU WILL NEED (not supplied):

- Input wiring cables
- Output wiring cables

Rack for mounting amplifier (or a stable surface for stacking)



WARNING: Before you start to set up your amplifier, make sure you read and observe the Important Safety Instructions found at the beginning of this manual.



3.2 Install Your Amplifier

CAUTION: Before you begin, make sure your amplifier is disconnected from the power source, with power switch in the "off" position and all level controls turned completely down (counterclockwise).

Use a standard 19-inch (48.3 cm) equipment rack. See Figure 3.1 for amplifier dimensions.

You may also stack amps without using a cabinet.

NOTE: When transporting, amplifiers should be supported at both front and back.

3.3 Ensure Proper Cooling

When using an equipment rack, mount units directly on top of each other. Close any open spaces in rack with blank panels. DO NOT block front or rear air vents. The side walls of the rack should be a minimum of two inches (5.1 cm) away from the amplifier sides, and the back of the rack should be a minimum of four inches (10.2 cm) from the amplifier back panel.

Figure 3.2 illustrates standard amplifier airflow.

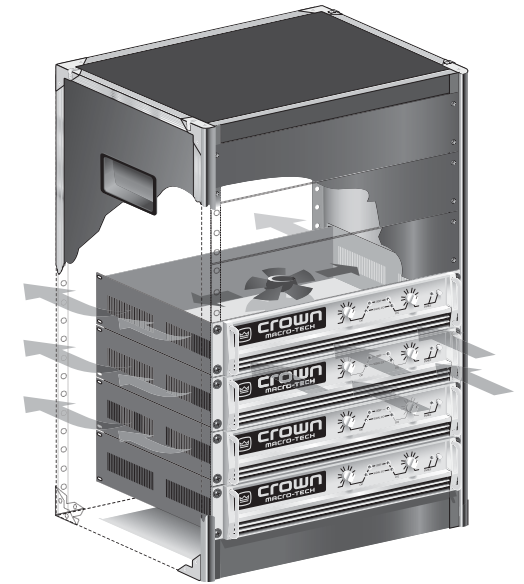

Figure 3.2 Airflow

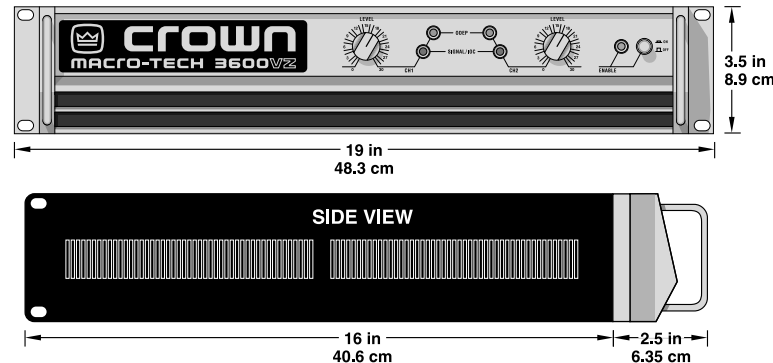

Figure 3.1 Dimensions

3 Setup

3.4 Choose Input Wire and Connectors

Figure 3.3 shows connector pin assignments for balanced wiring, and Figure 3.4 shows connector pin assignments for unbalanced wiring.



NOTE: Custom wiring should only be performed by qualified personnel.

Balanced Line

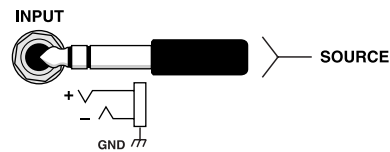
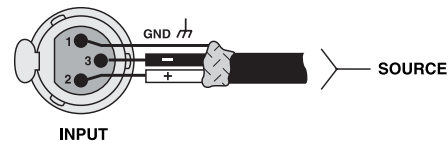

Figure 3.3 Balanced Input Connector Wiring

Unbalanced Line

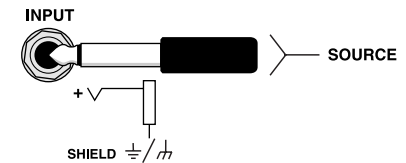
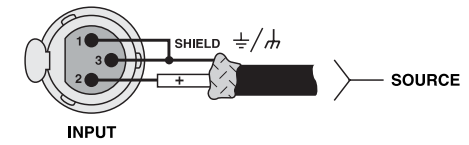

Figure 3.4 Unbalanced Input Connector Wiring

3 Setup

3.5 Choose Output Wire and Connectors

Crown recommends using pre-built or professionally wired, high-quality, two-conductor, heavy gauge speaker wire and connectors. You may use banana connectors, terminal forks or bare wire for your output connectors (see Figure 3.5). To prevent the possibility of short-circuits, wrap or otherwise insulate exposed loudspeaker cable connectors.



Note: Binding post outputs on European models come with safety plugs installed to prevent European power-cord plugs from being inserted. The side entry positions for these connectors should therefore be used.

Using the guidelines below, select the appropriate size of wire based on the distance from amplifier to speaker.

Distance	Wire Size
up to 25 ft.	16 gauge
26-40 ft.	14 gauge
41-60 ft.	12 gauge
61-100 ft.	10 gauge
101-150 ft.	8 gauge
151-250 ft.	6 gauge



CAUTION: Never use shielded cable for output wiring.

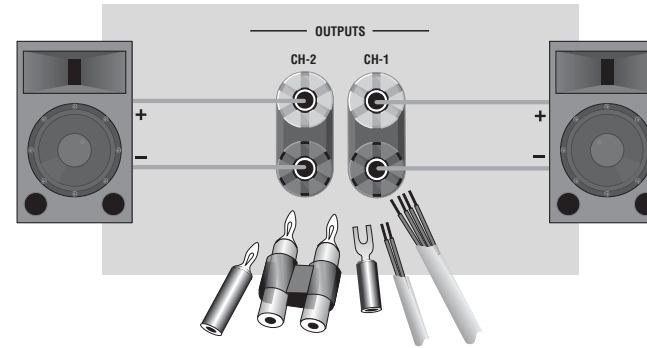

Figure 3.5 Output Connector Wiring
(MA-3600VZ Has 4 Pairs of Posts. Only 2 Pairs Are Shown.)

3 Setup

3.6 Wire Your System

3.6.1 Stereo Mode

Typical input and output wiring is shown in Figure 3.6.

INPUTS: Connect input wiring for each channel. Refer to Section 3.4 for input connector pin assignments.

OUTPUTS: Maintain proper polarity (+/-) on output connectors.

Connect positive (+) speaker lead to Channel 1 positive binding post of amp; connect negative (-) speaker lead to Channel 1 negative binding post of amp. Repeat for Channel 2. Refer to Section 3.5 for output connector pin assignments. Make sure the Mode switch set to the "Stereo" position when operating in Stereo mode.

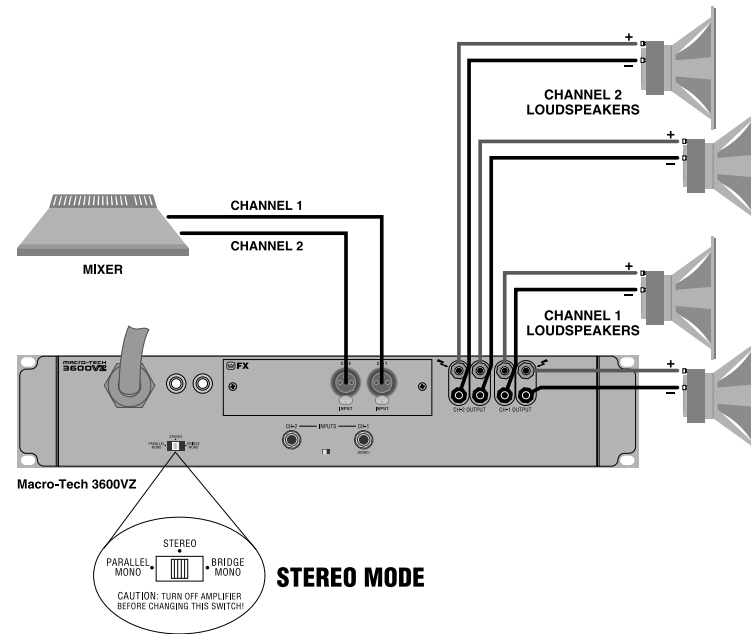

Figure 3.6 System Wiring, Stereo Mode

3.6.2 Bridge-Mono Mode

Typical input and output wiring is shown in Figure 3.7.

INPUTS: Connect input wiring to Channel 1. Refer to Section 3.4 for input connector pin assignments.

OUTPUTS: Connect positive (+) speaker lead to Channel 1 positive binding post of amp; connect negative (-) speaker lead to Channel 2 positive binding post of amp. Do not use the negative binding posts when operating in Bridge-Mono mode. Refer to Section 3.5 for output connector pin assignments. Make sure the Mode switch is set to the "Bridge" position when operating in Bridge-Mono mode.

NOTE: Turn down (full CCW) the Channel 2 level control when operating in Bridge-Mono mode, as the Channel 1 level control works both channels.

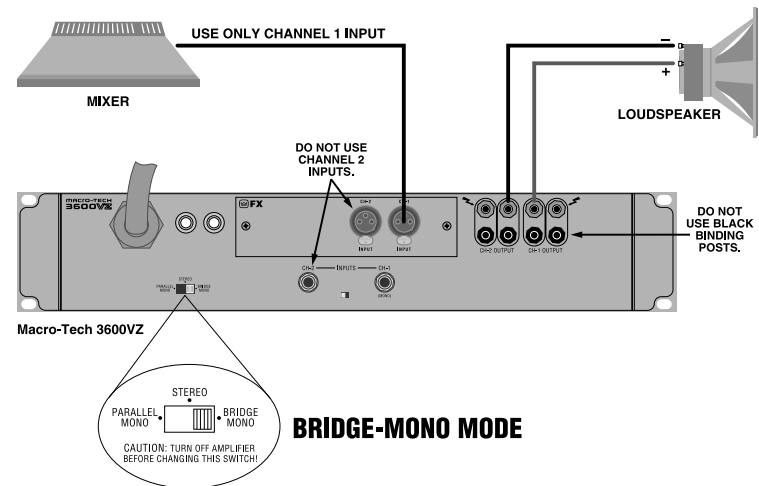

Figure 3.7 System Wiring, Bridge-Mono Mode

3 Setup

3.6.3 Parallel-Mono Mode

Typical input and output wiring is shown in Figure 3.8.

INPUTS: Connect input wiring to Channel 1. Refer to Section 3, Figure 3.4 for input connector pin assignments.

OUTPUTS: Install a jumper wire between the positive binding posts of both Channel 1 and Channel 2 that is at least 14 gauge in size; Connect positive (+) speaker lead to Channel 1 positive binding post of amp; connect negative (-) speaker lead to Channel 2 negative binding post of amp. Refer to Section 3.5 for output connector pin assignments. Make sure the Mode switch is set to the "Bridge" position when operating in Bridge-Mono mode.

NOTE: Turn down (full CCW) the Channel 2 level control when operating in Parallel-Mono mode, as the Channel 1 level control works both channels.

NOTE: Remove the jumper wire before changing to any mode except Parallel-Mono.

NOTE: Crown provides a reference of wiring pin assignments for commonly used connector types in the Crown *Amplifier Application Guide* available at www.crownaudio.com.

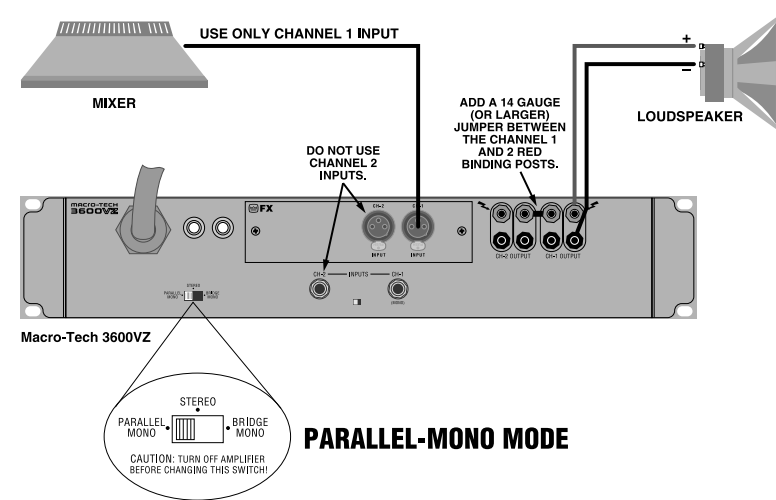

Figure 3.8 System Wiring, Parallel-Mono Mode

3 Setup

3.7 Connect to AC Mains

Connect the AC power cordset of your amplifier to the AC mains power source (power outlet).

NOTE: The third prong of this connector (ground) is an important safety feature. Do not attempt to disable this ground connection by using an adapter or other methods.

Amplifiers don't create energy. The AC mains voltage and current must be sufficient to deliver the power you expect. You must operate your amplifier from an AC mains power source with not more than 10% variation above or below the amplifier's specified line voltage and within the specified frequency requirements (indicated on the amplifier's back panel label). If you are unsure of the output voltage of your AC mains, please consult your electrician.

3.8 Startup Procedure

Use the following procedure when first turning on your amplifier:

1. Turn down the level of your audio source.
2. Turn down the level controls of the amplifier.
3. Turn on the "Enable" switch. The Enable indicator should glow.
4. Turn up the level of your audio source to an optimum level.
5. Turn up the Level controls on the amplifier until the desired loudness or power level is achieved.
6. Turn down the level of your audio source to its normal range.

If you ever need to make any wiring or installation changes, don't forget to turn off the amplifier and disconnect the power cord.

For help with determining your system's optimum gain structure (signal levels) please refer to the Crown *Amplifier Application Guide*, available online at www.crownaudio.com.

4 Operation

4.1 Precautions

Your Macro-Tech Series amplifier is protected from internal and external faults, but you should still take the following precautions for optimum performance and safety:

1. Before use, your amplifier first must be configured for proper operation, including input and output wiring hookup. Improper wiring can result in serious operating difficulties. For information on wiring and configuration, please consult the Setup section of this manual or, for advanced setup techniques, consult Crown's Amplifier Application Guide available online at www.crownaudio.com.
2. Use care when making connections, selecting signal sources and controlling the output level. The load you save may be your own!
3. Do not short the ground lead of an output cable to the input signal ground. This may form a ground loop and cause oscillations.

4. Never connect the output to a power supply, battery or power main. Electrical shock may result.



5. Tampering with the circuitry, or making unauthorized circuit changes, may be hazardous and invalidates all agency listings.
6. Do not operate the amplifier with the Signal/IOC LEDs constantly indicating an IOC condition.
7. Do not overdrive the mixer, which will cause a clipped signal to be sent to the amplifier. Such signals will be reproduced with extreme accuracy, and loudspeaker damage may result.
8. Never operate the amplifier with less than the rated load impedance. Due to the amplifier's output protection, such a configuration may result in premature clipping and speaker damage.

Remember: Crown is not liable for damage that results from overdriving other system components.

4 Operation

4.2 Front Panel Controls and Indicators

A. Dust Filter

Removes large particles from the air at the air intake. The filter elements can be easily removed for cleaning by gently pulling them away from the front panel.

B. Level Control

Rotary detented level control, one per channel.

C. Signal/IOC Indicator

Green LED, one per channel. Tri-purpose indicator illuminates to indicate the presence of output signals; flashes brightly with a 0.1-second hold delay to indicate a difference (distortion) between the input and output signal of 0.05% or greater; and flashes brightly with a 0.5-second hold delay to indicate input clipping distortion. See Section 5.1.2 for more about IOC.

D. ODEP Indicator

Amber LED, one per channel, illuminates brightly to indicate presence of thermodynamic energy. They dim proportionally as

energy reserves decrease. In the event that energy reserves are depleted, the indicators turn off and ODEP limiting occurs. See Section 5.1.1 for more about ODEP.

E. Enable Indicator

Amber LED indicates amplifier has been turned on and AC power is available.

F. Enable Switch

Amplifier is on when the switch is in the IN position.

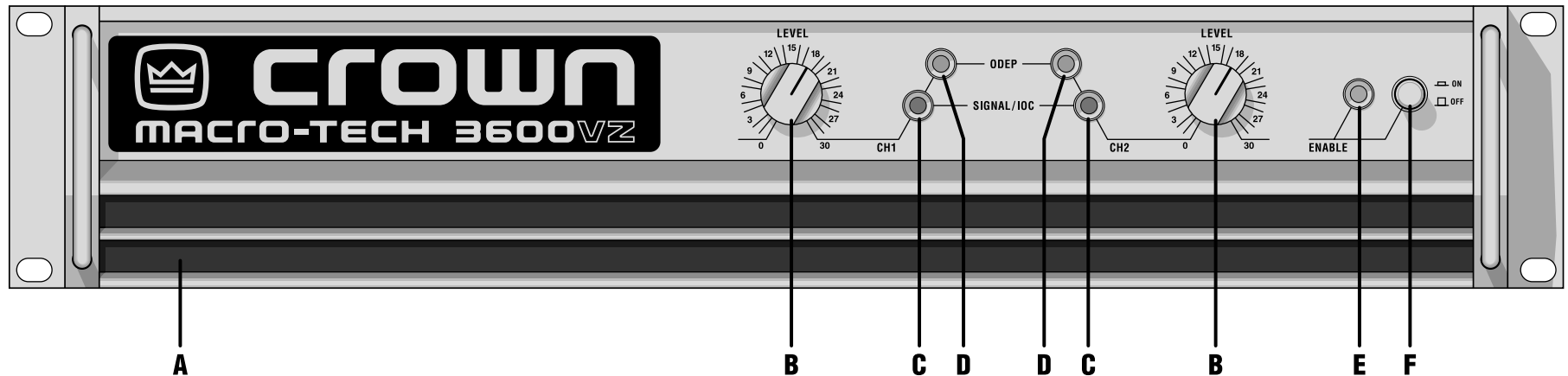

Figure 4.1 Front Panel Controls and Indicators

4 Operation

4.3 Back Panel Controls and Connectors

G. Power Cord

H. Stereo/Mono Switch

Allows selection of Stereo, Bridge-Mono, or Parallel-Mono operation.

I. Reset Button

One per channel. Resets the power supply breakers.

J. PIP Module

Standard module (PIP-FX) provides a 3-pin female XLR connector for signal input to each channel.

Input Sensitivity Switch

Located behind the PIP module is the Input Sensitivity switch. See Section 5.3.3 for details.

K. TRS Input Jack

One per channel; female TRS input jacks are provided.

L. Ground Lift Switch

When lifted, inserts an impedance between the sleeve of each TRS jack and the circuit ground to prevent ground loops. Switch has no effect on the input connectors on PIP modules. See Section 5.3.4 for details.

M. XLR Inputs (Standard PIP Module)

One per channel, female XLR input connectors are provided.

N. 5-Way Binding Post Output Jacks

One pair per channel; accepts banana plugs, spade lugs or bare wire. Note: Binding post outputs on European models come with safety plugs installed to prevent European power-cord plugs from being inserted. The side entry positions for these connectors should therefore be used.

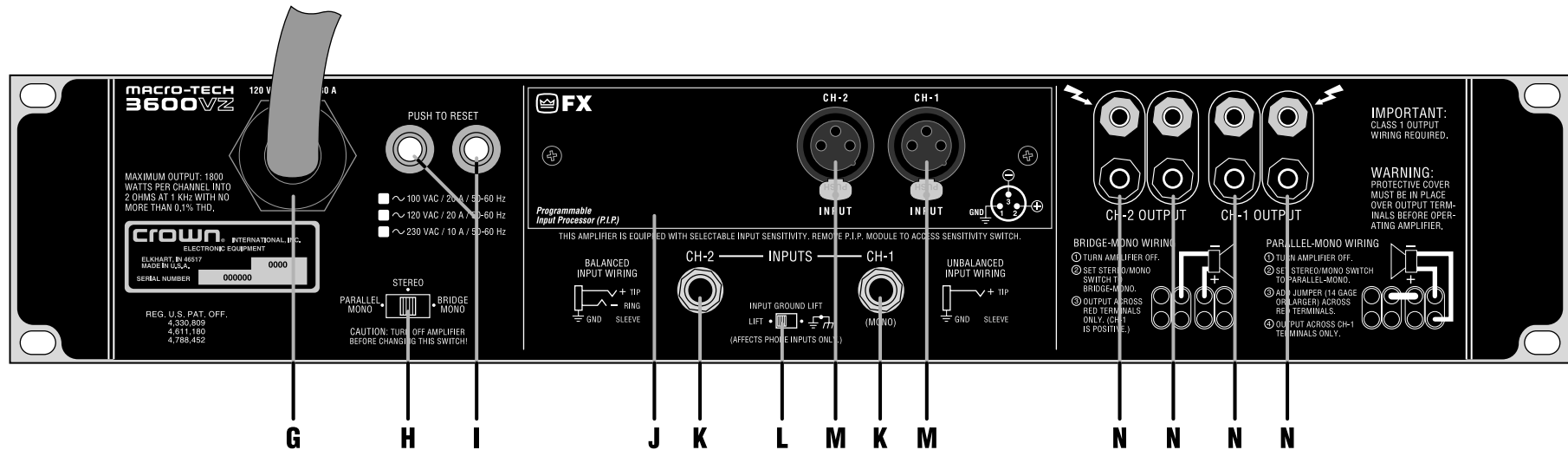

Figure 4.2 Back Panel Controls and Connectors

5 Advanced Features and Options

NOTE: For detailed information about these Crown amplifier features, please consult the *Crown Amplifier Application Guide*, available on the Crown website at www.crownaudio.com

5.1 Protection Systems

Your Crown amplifier provides extensive protection and diagnostic capabilities, including ODEP and IOC.

5.1.1 Output Device Emulation Protection (ODEP)

Crown invented ODEP to solve two long standing problems in amplifier design: To prevent amplifier shutdown during demanding operation and to increase the efficiency of output circuitry.

To do this, Crown established a rigorous program to measure the safe operating area (SOA) of each output transistor before installing it in an amplifier. Crown also designed intelligent circuitry to simulate the instantaneous operating conditions of those output transistors. Its name describes what it does: Output Device Emulation Protection or ODEP. It not only simulates the operation of the output transistors but it also compares their operation to their known SOA. If ODEP sees that more power is about to be asked of the output devices than they are capable of delivering under the present conditions, ODEP immediately limits the drive level until it falls within the SOA. Limiting is proportional and kept to an absolute minimum—only what is required to prevent the possibility of output transistor damage.

This level of protection enables Crown to increase output transistor utilization while greatly increasing amplifier reliability.

Finally, this onboard intelligence is monitored in two ways. First, the front panel ODEP indicators show whether the amplifier is functioning correctly or if ODEP is limiting the drive level. Second, ODEP data is fed to the PIP connector at the back of the amplifier so advanced PIP modules like the PIP-Lite can use it to make decisions and control the amplifier.

(The PIP-Lite can be used with the Macro-Tech 3600VZ.) With ODEP you get the maximum power with the maximum protection—the show goes on!

5.1.2 IOC (Input Output Comparator)

The IOC circuit compares the output signal of the amplifier with the input signal. If there is any difference other than gain, then it is considered distortion and the indicator comes on. The LED indicator will come on whenever there is distortion of 0.05% or more. An IOC condition may also be sensed by an IQ PIP module installed in PIP-compatible amplifiers.

IOC is designed to report any form of distortion. IOC not only checks the waveform for distortion, but also reports input overload and even a protective action that mutes or shuts down an amplifier. With all of these features, IOC monitors the entire amplifier. When the IOC indicator is off the amplifier is definitely operational and undistorted. IOC provides an on-line proof of performance.

5.2 Circuit Designs

5.2.1 Grounded Bridge

Grounded Bridge is the name of Crown's unique four-quadrant amplifier topology. The Grounded Bridge topology takes full advantage of the power supplies delivering peak-to-peak voltages to the load that are twice the voltage seen by the output devices and twice the voltage generated by the power supplies.

The power supply bridge rectifier is not ground referenced, and the transformer secondary is not center-tapped. This allows the power supply to deliver +VCC and -VCC from the same bridge rectifier and filter as a total difference in potential regardless of their voltages with respect to ground.

Composite output devices are arranged to function as gigantic NPN and PNP devices. Each output stage has two composite NPN and two composite PNP devices. The devices connected to the load are referred to as "high-side NPN and PNP" and the devices connected to

ground are referred to as "low-side NPN and PNP." Positive current is delivered to the load by increasing conductance simultaneously in the high-side NPN and low-side PNP stage, while decreasing conductance of the high-side PNP and low-side NPN in synchrony.

Crown's Grounded Bridge design delivers large voltage swings without stressing output transistors. The results are higher efficiency, lower distortion and superior reliability.

5.2.2 Variable Impedance (VZ)

VZ is the name of Crown's patented articulated power supply technology. This innovative technology permits us to pack large amounts of power into a compact package while achieving ultra-low distortion and without generating excessive heat.

An amplifier power supply must be large enough to handle both the maximum voltage and maximum current necessary for the amplifier to drive its rated power into a specified load. In order to meet this requirement, most conventional supplies are heavy, large, and produce lots of heat. In contrast, the VZ supply gets more current AND voltage out of a smaller, lighter, and more efficient package by dynamically adapting to both signal and load requirements in real-time. This provides the best power match to the widest range of loads.

The VZ supply is divided into two segments. When the output stage requires high-voltage, the segments are arranged in series to deliver twice the voltage of a single segment. When the output stage requires high-current, the segments are arranged in parallel to deliver twice the current of a single segment. Sensing circuitry "watches" the voltage of the signal to determine when to switch VZ modes. The switching circuitry is designed to prevent audible switching distortion to yield the highest possible dynamic transfer function—you hear only the music and not the amplifier.

With VZ, you get not only maximum power and safety, but you also get the best power matching to your load.

5 Advanced Features and Options

5.3 Options

5.3.1 IQ-PIP-USP2 Adapter and PIP-Lite Module

Available in limited quantity through Crown's Parts Department, the IQ-PIP-USP2 Adapter allows the amplifier to accept the Crown PIP-Lite module (but not the PIP-USP3 or PIP-USP3/CN.) Load monitoring and output voltage limiting are not available with the IQ-PIP-USP2 Adapter.

The PIP-Lite connects the amplifier to a 100 Mb Ethernet network allowing it to be remotely controlled and monitored via IQwic or System Architect.

The PIP-Lite is a TCP/IQ series component. This means it connects to Harman Pro System Architect software or an IQ System[®] via 100 Mb Ethernet. This provides faster IQ communications than the previous current loop, IQ bus, connectivity method. With this control network option, a large (or small) system can be interconnected using standard off-the-shelf 100 Mb Ethernet components (Switches, NICs, and cables). The PIP-Lite can also be connected to the same network used to pass CobraNet[™] audio¹.

The audio path in the PIP-Lite is processed totally in the analog domain. While DSP-type functions cannot be supported with this type of architecture, the standard SmartAmp features are. These features include input compressors, multimode output limiters, and error reporting.

5.3.2 Input Sensitivity Switch

The Input Sensitivity Switch is located inside the back of the amplifier (Figure 5.1). It is set at the factory to 0.775 volt for rated output into 8 ohms. It can also be switched to a sensitivity of 1.4 volts, or a fixed voltage gain of 26 dB (4.8 volts for rated output).

How to change the input sensitivity:

1. Turn off the amplifier and disconnect its power cord from the AC mains power receptacle.
2. Remove the PIP module (two screws).
3. Locate the sensitivity switch access hole inside the chassis opening as shown in Figure 5.1. It is located just above the phone jack inputs.
4. Set the switch to the desired position noted on the access hole label. The position toward the front panel sets the sensitivity to 1.4 volts for rated output, the middle position provides a voltage gain of 26 dB, and the position toward the back panel sets the sensitivity to 0.775 volt for rated output.
5. Replace the PIP module and restore the power.

5.3.3 Input Ground Lift Switch

The Input Ground Lift switch is located on the rear panel (Figure 5.1) and can provide isolation between the input signal ground and the AC ground. It affects only the phone jack inputs and has no effect on the input connectors on the PIP module. Sliding the switch to the left isolates or "lifts" the grounds by placing an impedance between the sleeve of each phone jack and the circuit ground.

When a PIP module is plugged into the amplifier, only the noninverted and inverted signal lines are connected in parallel with the corresponding lines of the input phone jacks. The signal grounds are not paralleled. For example, XLR pins 2 and 3 are connected in parallel with the tip and ring of the corresponding phone jack. However pin 1 of the XLR is not connected in parallel with the sleeve of the phone jack.

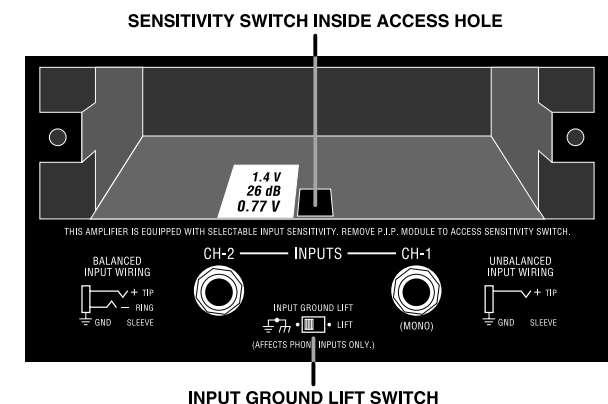

Figure 5.1 Input Sensitivity and Ground Lift Switches

¹ Note that the IQ-PIP-Lite cannot receive or transmit CobraNet audio.

6 Specifications

Minimum Guaranteed Power (see page 18 for complete power specifications)	120VAC, 60 Hz Units	100VAC International Units	120 VAC International Units	230VAC International Units
Power in watts per channel, 1 kHz, 0.1% THD				
Stereo mode with both channels driven				
2 ohms per ch.	1800W	1460W	1490W	1520W
4 ohms per ch.	1565W	1300W	1300W	1325W
8 ohms per ch.	1120W	980W	985W	965W
Bridge-Mono mode				
4 ohms	3505W	2835W	2980W	2800W
8 ohms	3140W	2625W	2600W	2515W
Parallel-Mono mode				
1 ohm	3555W	2820W	2980W	2910W
2 ohms	3190W	2585W	2600W	2565W
Performance (120V AC units in stereo mode with 8 ohm load)				
Frequency Response				
(at 1 watt, 20Hz - 20 kHz) see Figure 6.3	± 0.1 dB			
Phase Response				
(at 1 watt, 10Hz - 20 kHz) see Figure 6.6	±10°			
Signal to Noise Ratio below full bandwidth power				
20 Hz to 20 kHz	>100 dB			
A-weighted	>105 dB			
Total Harmonic Distortion (THD)				
at rated power, from 20 Hz to 1 kHz	< 0.05%			
at rated power, at 20 kHz	< 0.1%			
Intermodulation Distortion (IMD)				
60 Hz and 7 kHz at 4:1, from 368 milliwatts to full rated output	< 0.05%			
Damping Factor				
10 Hz to 400 Hz See Figure 6.4	>1000			
Crosstalk				
(below rated power, 20 Hz to 10 kHz)	see Figure 6.7			
Controlled Slew Rate				
	> 30 volts/microsecond			
Input Impedance nominally balanced, nominally unbalanced				
	20 k ohms, 10 k ohms			

6 Specifications

Performance (continued)	
Output Impedance	See Figure 6.5
Load Impedance (Note: Safe with all types of loads)	
Stereo	2-8 ohms
Bridge Mono	4-8 ohms
Parallel Mono	1-2 ohms
Voltage Gain (8-ohm load, rated output at 1 kHz, maximum level setting)	
0.775V sensitivity	124.6:1 ±6% or 41.9 dB ±0.5 dB
1.4V sensitivity	69.2:1 ± 6% or 36.8 dB ±0.5 dB
26 dB sensitivity	20:1 ±6% or 26 dB ±0.5 dB
Required AC Mains	50/60 Hz; 100-, 120-, and 230 - VAC (±10%) units are available. 230 VAC, 50/60 Hz units can be used with 220 and 240 VAC. 100 and 120 VAC units can draw up to 30 amps; 230 VAC units can draw up to 15 amps. Current, voltage and frequency requirements are provided on the unit's back panel.
Power Draw at Idle	90 watts or less
Construction	
Cooling	Internal heat sinks with forced-air cooling for rapid, uniform heat dissipation
Dimensions	
Width	EIA Standard 19-inch rack mount (EIA RS-310-B)
Height	3.5 inch (8.9 cm)
Depth (behind mounting surface)	16 inch (40.6 cm)
Weight	
Center of gravity is 6 inches (15.2 cm) behind the front mounting surface.	
120 VAC, 60 Hz Units	
Net	55 pounds, 1.5 ounces (25.0 kg)
Shipping	63 pounds, 10 ounces (28.9 kg)
100 VAC, International Units	
Net	54 pounds, 5 ounces (24.7 kg)
Shipping	63 pounds, 0.5 ounces (28.6 kg)
120 VAC, International Units	
Net	55 pounds, 1.5 ounces (25.0 kg)
Shipping	63 pounds, 10 ounces (28.9 kg)
230 VAC, International Units	
Net	53 pounds, 6 ounces (24.2 kg)
Shipping	61 pounds, 15 ounces (28.1 kg)

6 Specifications

Macro-Tech 3600VZ – Minimum Power (Watts)							
AC Mains	Stereo/Mono Mode	Load (Ohms)	Maximum Average			FTC Continuous Average	
			0.1% THD+N (See note 1)	0.1% THD+N (See note 2)	0.05% THD+N (See note 3)	0.1% THD + Noise (See note 4)	
			1 kHz	20Hz-20kHz	1 kHz	1 kHz	20Hz-20kHz
120 VAC, 60 Hz Units	Stereo (both channels driven)	2	1800		1785		
		4	1565		1555		
		8	1120	1035	1110	1060	885
	Bridge-Mono (balanced output)	4	3505		3490		
		8	3140		3110		
		16	2210		2190	2115	<680
	Parallel-Mono	1	3555		3530		
		2	3190		3155		
		4	2235		2225	2140	
100 VAC Transformer	Stereo (both channels driven)	2	1460		1360		
		4	1300		1290		
		8	980	940	970	895	850
	Bridge-Mono (balanced output)	4	2835		2825		
		8	2625		2600		
		16	1950		1940	1780	<680
	Parallel-Mono	1	2820		2810		
		2	2585		2550		
		4	1940		1925	1785	
230 VAC Transformer	Stereo (both channels driven)	2	1520		1495		
		4	1325		1300		
		8	965	955	930	870	275
	Bridge-Mono (balanced output)	4	2800		2740		
		8	2515		2445		
		16	1900	1765	1855	1735	
	Parallel-Mono	1	2910		2840		
		2	2565		2520		
		4	1935		1915	1750	

Figure 6.1 Minimum Power Matrix

Macro-Tech 3600VZ – Maximum Power (Watts)										
AC Mains	Stereo/Mono Mode	Load (Ohms)	Single Cycle Tone Burst 0.05% Distortion + Noise (See note 1)				40 Millisecond Tone Burst 0.05% Distortion + Noise (See note 2)			
			20 Hz	50 Hz	1 kHz	7 kHz	50 Hz	1 kHz	7 kHz	
			120 VAC, 60 Hz Units	Stereo (both channels driven)	2	1915	2320	2375	1610	2320
4	1670	2230			3270	3140	1860	1690	1745	
8	1260	1460			1830	1760	1295	1175	1235	
Bridge-Mono (balanced output)	4	3815		4630	4670	2930	4520	3920	2930	
	8	3315		4425	6495	6140	3735	3315	3355	
	16	2375		2915	3605	3460	2565	2325	2420	
Parallel-Mono	1	3810		4240	4310	2880	4240	3910	2880	
	2	3310		4500	6480	6125	3685	3345	3380	
	4	2475		2920	3655	3485	2545	2355	2425	
100 VAC Transformer	Stereo (both channels driven)	2		1535	2175	2285	1490	1930	1655	1490
		4		1375	2065	3220	3170	1620	1495	1530
		8		1110	1370	1810	1770	1155	1110	1155
	Bridge-Mono (balanced output)	4	3060	4325	4575	2715	3745	3300	2715	
		8	2745	4055	6425	6270	3310	2950	3020	
		16	2190	2725	3625	3510	2330	2215	2285	
	Parallel-Mono	1	3065	4045	4245	2680	3820	3300	2680	
		2	2760	4145	6465	6260	3250	2965	3035	
		4	2210	2755	3645	3500	2325	2210	2275	
	230 VAC Transformer	Stereo (both channels driven)	2	1650	2310	2365	1695	2005	1665	1695
			4	1450	2030	3030	2890	1655	1435	1485
			8	1060	1330	1695	1615	1160	1060	1095
Bridge-Mono (balanced output)		4	3355	4570	4645	2935	4040	3385	2935	
		8	2905	4095	6050	5765	3280	2870	2940	
		16	2115	2675	3345	3215	2890	2095	2160	
Parallel-Mono		1	2860	4275	4380	3240	3870	2945	3030	
		2	2565	3685	6005	5770	3185	2630	2690	
		4	1955	2515	3390	3230	2270	1975	2035	

Figure 6.2 Maximum Power Matrix

6 Specifications

Figure 6.3 Typical Frequency Response

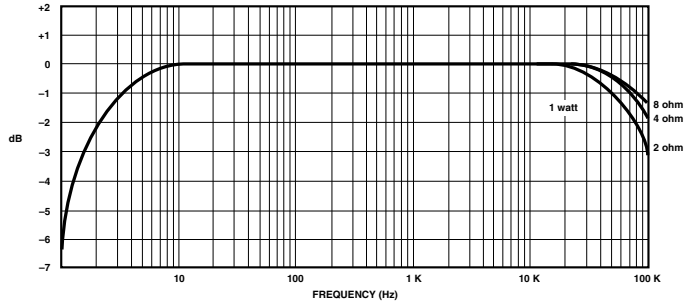

Figure 6.6 Typical Phase Response

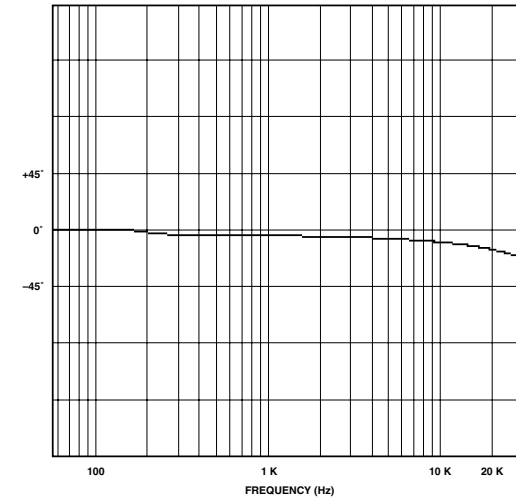

Figure 6.4 Typical Damping Factor

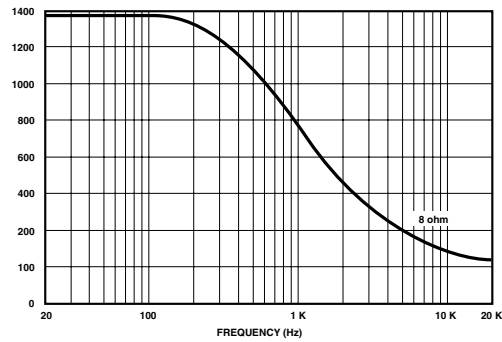

Figure 6.7 Typical Crosstalk

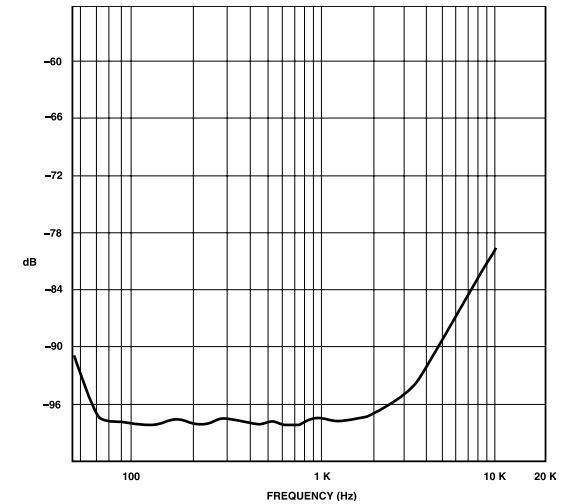
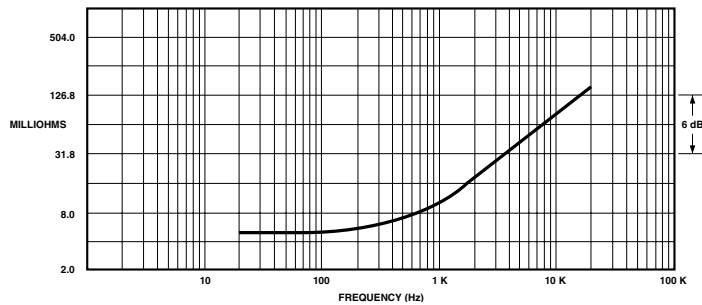











Figure 6.5 Typical Output Impedance



7 Troubleshooting

— one or more channels —

SIGNAL/IOC	ODEP	ENABLE
		
SIGNAL/IOC	ODEP	ENABLE
		









SIGNAL/IOC CH2 Only	ODEP	ENABLE
		

CONDITION: Normal operation.

POSSIBLE REASON:

- This is normal operation for your amp.
- The amp is set for Parallel Mono mode.

— one or more channels —

SIGNAL/IOC	ODEP	ENABLE
		
SIGNAL/IOC	ODEP	ENABLE
		
SIGNAL/IOC	ODEP	ENABLE
		

CONDITION: Distorted sound.



POSSIBLE REASON:

- Input signal level is too high. Turn down your amplifier level controls. NOTE: Your amplifier should never be operated at a level which causes the Signal/IOC LEDs to constantly indicate an IOC condition.
- ODEP limiting has been activated. Take appropriate measures to keep the amplifier out of ODEP limiting (see Section 5.1.1 for more information about ODEP).

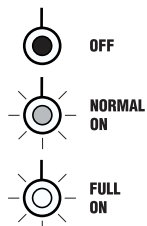
Key



— one or more channels —



SIGNAL/IOC	ODEP	ENABLE
		

CONDITION: No power to the amplifier.

POSSIBLE REASON:

- The amplifier's Power switch is off.
- The amplifier is not plugged into the power receptacle.
- The amplifier's low-voltage power supply fuse has blown. Return amp to Crown or an authorized Crown Service Center for servicing.



— one or more channels —

SIGNAL/IOC	ODEP	ENABLE
		



CONDITION: No sound.

POSSIBLE REASON:

- The amplifier has just been turned on and is still in the 4-second turn-on delay.
- The amplifier is being held in Standby Mode by an installed IQ PIP module.

SIGNAL/IOC	ODEP	ENABLE
		

- ODEP limiting has been activated. Take appropriate measures to keep the amplifier out of ODEP limiting (see Section 5.1.1 for more information about ODEP).
- The amplifier is in drive protection mode. This can occur with improper source signals like infrasonic square waves or input overloads that excessively clip the input signal.
- The amplifier's circuit breakers have tripped. Reset circuit breakers. If the trip again, return amp to Crown or an authorized Crown Service Center for servicing.

— one or more channels —		
SIGNAL/IOC	ODEP	ENABLE
		

- No input signal
- Input signal level is very low.
- Level controls are turned down.

8 Service

Crown amplifiers are quality units that rarely require servicing. Before returning your unit for service, please contact Crown Technical Support to verify the need for servicing.

This unit has very sophisticated circuitry which should only be serviced by a fully trained technician. This is one reason why each unit bears the following label:

CAUTION: To prevent electric shock, do not remove covers. No user serviceable parts inside. Refer servicing to a qualified technician.



Complete the Crown Audio Factory Service Information form, in the back of this manual, when returning a Crown product to the factory or authorized service center. The form must be included with your product inside the box or in a packing slip envelope securely attached to the outside of the shipping carton. Do not send this form separately.

8.1 International and Canada Service

Service may be obtained from an authorized service center. (Contact your local Crown/Amcron representative or our office for a list of authorized service centers.) To obtain service, simply present the bill of sale as proof of purchase along with the defective unit to an authorized service center. They will handle the necessary paperwork and repair.

Remember to transport your unit in the original factory pack.

8.2 US Service

Service may be obtained in one of two ways: from an authorized service center or from the factory. You may choose either. It is important that you have your copy of the bill of sale as your proof of purchase.

8.2.1 Service at a US Service Center

This method usually saves the most time and effort. Simply present your bill of sale along with the defective unit to an authorized service center to obtain service. They will handle the necessary paperwork and repair. Remember to transport the unit in the original factory pack. A list of authorized service centers in your area can be obtained from Crown Factory Service, or online from <http://www.crownaudio.com/support/servcent.htm>.

8.2.2 Factory Service

Crown accepts no responsibility for non-serviceable product that is sent to us for factory repair. It is the owner's responsibility to ensure that their product is serviceable prior to sending it to the factory. Serviceable product list is available at <http://crownweb.crownintl.com/crownrma/>. For more information, please contact us direct.

A Service Return Authorization (SRA) is required for product being sent to the factory for repair. An SRA can be completed online at www.crownaudio.com/support/factserv.htm. If you do not have access to the web, please call Crown's Customer Service at 574.294.8200 or 800.342.6939 extension 8205.

For warranty service, we will pay for ground shipping both ways in the United States. Contact Crown Customer Service to obtain prepaid shipping labels prior to sending the unit. Or, if you prefer, you may prepay the cost of shipping, and Crown will reimburse you. Send copies of the shipping receipts to Crown to receive reimbursement. Your repaired unit will be returned via UPS ground. Please contact us if other arrangements are required.

8.2.3 Factory Service Shipping Instructions:

1. Service Return Authorization (SRA) is required for product being sent to the factory for service. Please complete the SRA by going to www.crownaudio.com/support/factserv.htm. If you do not have access to our website, call 1.800.342.6939, extension 8205 and we'll create the SRA for you.
2. See packing instructions that follow.
3. Ship product to:
CROWN AUDIO FACTORY SERVICE
1718 W MISHAWKA RD.
ELKHART, IN 46517
4. Use a bold black marker and write the SRA number on three sides of the box.
5. Record the SRA number for future reference. The SRA number can be used to check the repair status.

8.2.4 Packing Instructions

Important: These instructions must be followed. If they are not followed, Crown Audio, Inc. assumes no responsibility for damaged goods and/or accessories that are sent with your unit.

1. Fill out and include the Crown Audio Factory Service Information sheet in the back of this manual.
2. Do not ship any accessories (manuals, cords, hardware, etc.) with your unit. These items are not needed to service your product. We will not be responsible for these items.
3. When shipping your Crown product, it is important that it has adequate protection. We recommend you use the original pack material when returning the product for repair. If you do not have the original box, please call Crown at 800.342.6939 or 574.294.8210 and order new pack material. See instructions for "foam-in-place" shipping pack. (Do not ship your unit in a wood or metal cabinet.)
4. If you provide your own shipping pack, the minimum recommended requirements for materials are as follows:
 - a. 275 P.S.I. burst test, Double-Wall carton that allows for 2-inch solid Styrofoam on all six sides of unit or 3 inches of plastic bubble wrap on all six sides of unit.
 - b. Securely seal the package with an adequate carton sealing tape.
 - c. Do not use light boxes or "peanuts". Damage caused by poor packaging will not be covered under warranty.

Using your 'foam-in-place' shipping pack

Note: The foam-in-place packing is molded so that there is only one correct position for your product.

1. Open carton and lift center cushion leaving both end-cushions in place.
2. Carefully place your product with the product's front panel facing the same direction as arrows indicate.

3. Reset center cushion down over top of product's chassis. The foam-in-place packing was molded to accommodate different chassis depth sizes. If your product's chassis does not completely fill the foam-in-place cavity, you may use a soft but solid packing material (such as paper or bubble wrap) behind the chassis.
4. Enclose the completed Crown Audio Factory Service Information form (or securely attach it to the outside of carton) and re-seal the shipping pack with a sturdy carton sealing tape.

8.2.5 Estimate Approval

Approval of estimate must be given within 90 days after being notified by Crown Audio Inc. Units still in the possession of Crown after 90 days of the estimate will become the property of Crown Audio Inc.

8.2.6 Payment of Non-Warranty Repairs

Payment on out-of-warranty repairs must be received within 90 days of the repair date. Units unclaimed after 90 days become the property of Crown Audio Inc.

If you have any questions, please contact Crown Factory Service.

Crown Factory Service
1718 W. Mishawaka Rd.,
Elkhart, Indiana 46517 U.S.A.

Telephone:
574.294.8200
800.342.6939 (North America,
Puerto Rico, and Virgin Islands only)

Facsimile:
574.294.8301 (Technical Support)
574.294.8124 (Factory Service)

Internet:
<http://www.crownaudio.com>

9 Warranty



UNITED STATES & CANADA

SUMMARY OF WARRANTY

Crown International, 1718 West Mishawaka Road, Elkhart, Indiana 46517-4095 U.S.A. warrants to you, the ORIGINAL PURCHASER and ANY SUBSEQUENT OWNER of each NEW Crown product, for a period of three (3) years from the date of purchase by the original purchaser (the "warranty period") that the new Crown product is free of defects in materials and workmanship. We further warrant the new Crown product regardless of the reason for failure, except as excluded in this Warranty.

ITEMS EXCLUDED FROM THIS CROWN WARRANTY

This Crown Warranty is in effect only for failure of a new Crown product which occurred within the Warranty Period. It does not cover any product which has been damaged because of any intentional misuse, accident, negligence, or loss which is covered under any of your insurance contracts. This Crown Warranty also does not extend to the new Crown product if the serial number has been defaced, altered, or removed.

WHAT THE WARRANTOR WILL DO

We will remedy any defect, regardless of the reason for failure (except as excluded), by repair, replacement, or refund. We may not elect refund unless you agree, or unless we are unable to provide replacement, and repair is not practical or cannot be timely made. If a refund is elected, then you must make the defective or malfunctioning product available to us free and clear of all liens or other encumbrances. The refund will be equal to the actual purchase price, not including inter-

est, insurance, closing costs, and other finance charges less a reasonable depreciation on the product from the date of original purchase. Warranty work can only be performed at our authorized service centers or at the factory. Warranty work for some products can only be performed at our factory. We will remedy the defect and ship the product from the service center or our factory within a reasonable time after receipt of the defective product at our authorized service center or our factory. All expenses in remedying the defect, including surface shipping costs in the United States, will be borne by us. (You must bear the expense of shipping the product between any foreign country and the port of entry in the United States including the return shipment, and all taxes, duties, and other customs fees for such foreign shipments.)

HOW TO OBTAIN WARRANTY SERVICE

You must notify us of your need for warranty service within the warranty period. All components must be shipped in a factory pack, which, if needed, may be obtained from us free of charge. Corrective action will be taken within a reasonable time of the date of receipt of the defective product by us or our authorized service center. If the repairs made by us or our authorized service center are not satisfactory, notify us or our authorized service center immediately.

DISCLAIMER OF CONSEQUENTIAL AND INCIDENTAL DAMAGES

YOU ARE NOT ENTITLED TO RECOVER FROM US ANY INCIDENTAL DAMAGES RESULTING

FROM ANY DEFECT IN THE NEW CROWN PRODUCT. THIS INCLUDES ANY DAMAGE TO ANOTHER PRODUCT OR PRODUCTS RESULTING FROM SUCH A DEFECT. SOME STATES DO NOT ALLOW THE EXCLUSION OR LIMITATIONS OF INCIDENTAL OR CONSEQUENTIAL DAMAGES, SO THE ABOVE LIMITATION OR EXCLUSION MAY NOT APPLY TO YOU.

WARRANTY ALTERATIONS

No person has the authority to enlarge, amend, or modify this Crown Warranty. This Crown Warranty is not extended by the length of time which you are deprived of the use of the new Crown product. Repairs and replacement parts provided under the terms of this Crown Warranty shall carry only the unexpired portion of this Crown Warranty.

DESIGN CHANGES

We reserve the right to change the design of any product from time to time without notice and with no obligation to make corresponding changes in products previously manufactured.

LEGAL REMEDIES OF PURCHASER

THIS CROWN WARRANTY GIVES YOU SPECIFIC LEGAL RIGHTS, YOU MAY ALSO HAVE OTHER RIGHTS WHICH VARY FROM STATE TO STATE. No action to enforce this Crown Warranty shall be commenced after expiration of the warranty period.

THIS STATEMENT OF WARRANTY SUPERSEDES ANY OTHERS CONTAINED IN THIS MANUAL FOR CROWN PRODUCTS. 12/01

9 Warranty



WORLDWIDE EXCEPT USA & CANADA

SUMMARY OF WARRANTY

Crown International, 1718 West Mishawaka Road, Elkhart, Indiana 46517-4095 U.S.A. warrants to you, the ORIGINAL PURCHASER and ANY SUBSEQUENT OWNER of each NEW Crown1 product, for a period of three (3) years from the date of purchase by the original purchaser (the "warranty period") that the new Crown product is free of defects in materials and workmanship, and we further warrant the new Crown product regardless of the reason for failure, except as excluded in this Warranty.

¹ Note: If your unit bears the name "Amcron," please substitute it for the name "Crown" in this warranty.

ITEMS EXCLUDED FROM THIS CROWN-WARRANTY

This Crown Warranty is in effect only for failure of a new Crown product which occurred within the Warranty Period. It does not cover any product which has been damaged because of any intentional misuse, accident, negligence, or loss which is covered under any of your insurance contracts. This Crown Warranty also does not extend to the new Crown product if the serial number has been defaced, altered, or removed.

WHAT THE WARRANTOR WILL DO

We will remedy any defect, regardless of the reason for failure (except as excluded), by repair,

replacement, or refund. We may not elect refund unless you agree, or unless we are unable to provide replacement, and repair is not practical or cannot be timely made. If a refund is elected, then you must make the defective or malfunctioning product available to us free and clear of all liens or other encumbrances. The refund will be equal to the actual purchase price, not including interest, insurance, closing costs, and other finance charges less a reasonable depreciation on the product from the date of original purchase. Warranty work can only be performed at our authorized service centers. We will remedy the defect and ship the product from the service center within a reasonable time after receipt of the defective product at our authorized service center.

HOW TO OBTAIN WARRANTY SERVICE

You must notify your local Crown importer of your need for warranty service within the warranty period. All components must be shipped in the original box. Corrective action will be taken within a reasonable time of the date of receipt of the defective product by our authorized service center. If the repairs made by our authorized service center are not satisfactory, notify our authorized service center immediately.

DISCLAIMER OF CONSEQUENTIAL AND INCIDENTAL DAMAGES

YOU ARE NOT ENTITLED TO RECOVER FROM US ANY INCIDENTAL DAMAGES RESULTING FROM ANY DEFECT IN THE NEW CROWN PRODUCT. THIS INCLUDES ANY DAMAGE TO ANOTHER PRODUCT OR PRODUCTS RESULTING FROM SUCH A DEFECT.

WARRANTY ALTERATIONS

No person has the authority to enlarge, amend, or modify this Crown Warranty. This Crown Warranty is not extended by the length of time which you are deprived of the use of the new Crown product. Repairs and replacement parts provided under the terms of this Crown Warranty shall carry only the unexpired portion of this Crown Warranty.

DESIGN CHANGES

We reserve the right to change the design of any product from time to time without notice and with no obligation to make corresponding changes in products previously manufactured.

LEGAL REMEDIES OF PURCHASER

No action to enforce this Crown Warranty shall be commenced after expiration of the warranty period.

THIS STATEMENT OF WARRANTY SUPERSEDES ANY OTHERS CONTAINED IN THIS MANUAL FOR CROWN PRODUCTS. 7/01

NOTES



PRODUCT REGISTRATION

Crown International
 1718 W. Mishawaka Rd.
 Elkhart, IN 46517-9439
 Phone: 574-294-8000
 Fax: 574-294-8329
 www.crownaudio.com

Online registration is also available at <http://crownweb.crownintl.com/webregistration>

When this form is used to register your product, it may be mailed or faxed.

Crown International Fax: 574-294-8329
 1718 W Mishawaka Rd
 Elkhart IN 46517

Please note that some information is required. Incomplete registrations will not be processed. * Indicates required information.

OWNER'S INFORMATION - PLEASE PRINT

* First name: _____ Middle initial: _____ * Last name: _____
 Company: _____
 * Mailing address: _____
 * City: _____ * State: _____ * Zip Code: _____
 * Country: _____ E-mail address: _____
 * Phone # (include area code): _____ Fax #: _____

PRODUCT INFORMATION

* MODEL	* SERIAL #	PURCHASE DATE
ie. I-T8000, CDi 1000, PCC-160		mo/day/yr
_____	_____	____/____/____
_____	_____	____/____/____
_____	_____	____/____/____
_____	_____	____/____/____

Product purchased from: _____ City: _____ State: _____

Comments: _____

CUT ON THIS LINE

THIS PAGE INTENTIONALLY LEFT BLANK



Crown Factory Service Information

Shipping Address: Crown Factory Service, 1718 W. Mishawaka Rd., Elkhart, IN 46517

Phone: 1-800-342-6939 or 1-574-294-8200 Fax: 1-574-294-8124

Owner's Name : _____

Shipping Address: _____

Phone Number: _____ Fax Number: _____ Email address: _____

Model: _____ Serial Number: _____

Purchase Date : _____

NATURE OF PROBLEM

(Be sure to describe the conditions that existed when the problem occurred and what attempts were made to correct it.)

Other equipment in system: _____

If warranty has expired, payment will be: Cash/Check VISA MasterCard C.O.D. Purchase Order for Crown Dealer

Card Number: _____ Exp. Date: _____

Signature: _____

ENCLOSE THIS PORTION WITH THE UNIT. DO NOT MAIL SEPARATELY.



H A Harman International Company

Free Manuals Download Website

<http://myh66.com>

<http://usermanuals.us>

<http://www.somanuals.com>

<http://www.4manuals.cc>

<http://www.manual-lib.com>

<http://www.404manual.com>

<http://www.luxmanual.com>

<http://aubethermostatmanual.com>

Golf course search by state

<http://golfingnear.com>

Email search by domain

<http://emailbydomain.com>

Auto manuals search

<http://auto.somanuals.com>

TV manuals search

<http://tv.somanuals.com>