



Macro-Tech Series

Operation Manual



MA-24X6

MA-36X12

Obtaining Other Language Versions: To obtain information in another language about the use of this product, please contact your local Crown Distributor. If you need assistance locating your local distributor, please contact Crown at 574-294-8000.

This manual does not include all of the details of design, production, or variations of the equipment. Nor does it cover every possible situation which may arise during installation, operation or maintenance.

Note: The information provided in this manual was deemed accurate as of the publication date. However, updates to this information may have occurred. To obtain the latest version of this manual, please visit the Crown website at www.crownaudio.com.

Trademark Notice: SmartAmp, Grounded Bridge and PIP are trademarks and Amcron, Crown, Macro-Tech, IOC, ODEP, IQ, IQ System, and P.I.P. are registered trademarks of Crown International. Other trademarks are the property of their respective owners.

Some models may be exported under the name Amcron.®

©2003 by Crown Audio, Inc. P.O. Box 1000, Elkhart, Indiana 46515-1000 U.S.A. Telephone: 574-294-8000

H A Harman International Company

Download from Www.Somanuals.com. All Manuals Search And Download.

125782-5
6/03

Important Safety Instructions

- 1) Read these instructions.
- 2) Keep these instructions.
- 3) Heed all warnings.
- 4) Follow all instructions.
- 5) Do not use this apparatus near water.
- 6) Clean only with a dry cloth.
- 7) Do not block any ventilation openings. Install in accordance with the manufacturer's instructions.
- 8) Do not install near any heat sources such as radiators, heat registers, stoves, or other apparatus that produce heat.
- 9) Do not defeat the safety purpose of the polarized or grounding-type plug. A polarized plug has two blades with one wider than the other. A grounding-type plug has two blades and a third grounding prong. The wide blade or the third prong is provided for your safety. If the provided plug does not fit into your outlet, consult an electrician for replacement of the obsolete outlet.
- 10) Protect the power cord from being walked on or pinched, particularly at plugs, convenience receptacles, and the point where they exit from the apparatus.
- 11) Only use attachments/accessories specified by the manufacturer.
- 12) Use only with a cart, stand, bracket, or table specified by the manufacturer, or sold with the apparatus. When a cart is used, use caution when moving the cart/apparatus combination to avoid injury from tip-over.
- 13) Unplug this apparatus during lightning storms or when unused for long periods of time.
- 14) Refer all servicing to qualified service personnel. Servicing is required when the apparatus has been damaged in any way, such as power-supply cord or plug is damaged, liquid has been spilled or objects have fallen into the apparatus, the apparatus has been exposed to rain or moisture, does not operate normally, or has been dropped.
- 15) To reduce the risk of fire or electric shock, do not expose this apparatus to rain or moisture.



TO PREVENT ELECTRIC SHOCK DO NOT REMOVE TOP OR BOTTOM COVERS. NO USER SERVICEABLE PARTS INSIDE. REFER SERVICING TO QUALIFIED SERVICE PERSONNEL.



À PRÉVENIR LE CHOC ÉLECTRIQUE N'ENLEVEZ PAS LES COUVERCLES. IL N'Y A PAS DES PARTIES SERVICEABLE À L'INTÉRIEUR. TOUS REPARATIONS DOIT ÊTRE FAIRE PAR PERSONNEL QUALIFIÉ SEULEMENT.



CAUTION
RISK OF ELECTRIC SHOCK
DO NOT OPEN

AVIS
RISQUE DE CHOC ÉLECTRIQUE
N'OUVREZ PAS

IMPORTANT

MA Series amplifiers require Class 2 output wiring.



MAGNETIC FIELD

CAUTION! Do not locate sensitive high-gain equipment such as preamplifiers or tape decks directly above or below the unit. Because this amplifier has a high power density, it has a strong magnetic field which can induce hum into unshielded devices that are located nearby. The field is strongest just above and below the unit.



If an equipment rack is used, we recommend locating the amplifier(s) in the bottom of the rack and the preamplifier or other sensitive equipment at the top.

WATCH FOR THESE SYMBOLS:

The lightning bolt triangle is used to alert the user to the risk of electric shock.



The exclamation point triangle is used to alert the user to important operating or maintenance instructions.



FCC COMPLIANCE NOTICE

This device complies with part 15 of the FCC rules. Operation is subject to the following two conditions: (1) This device may not cause harmful interference, and (2) this device must accept any interference received, including interference that may cause undesired operation.

CAUTION: Changes or modifications not expressly approved by the party responsible for compliance could void the user's authority to operate the equipment.

NOTE: This equipment has been tested and found to comply with the limits for a Class B digital device, pursuant to part 15 of the FCC Rules. These limits are designed to provide reasonable protection against harmful interference in a residential installation. This equipment generates, uses, and can radiate radio frequency energy and, if not installed and used in accordance with the instruction manual, may cause harmful interference to radio communications. However, there is no guarantee that interference will not occur in a particular installation. If this equipment does cause harmful interference to radio or television reception, which can be determined by turning the equipment off and on, the user is encouraged to try to correct the interference by one or more of the following measures:

- Reorient or relocate the receiving antenna.
- Increase the separation between the equipment and receiver.
- Connect the equipment into an outlet on a circuit different from that to which the receiver is connected.
- Consult the dealer or an experienced radio/TV technician for help.

Crown International, Inc.

DECLARATION of CONFORMITY

TCF Technical Certificate No: P4300CRI1.IWS

Technical Construction File Route

Issued By: Crown International, Inc.
1718 W. Mishawaka Road
Elkhart, Indiana 46517 U.S.A.

Sue Whitfield
574-294-8289
swhitfield@crowintl.com

Competent Body's Name and Address:

Technology International (Europe) Limited
41-42 Shrivensham Hundred Business Park,
Shrivensham, Swindon, Wilts, SN6 8TZ

European Representative's Name and Address:

Nick Owen
19 Clos Nant Coslech
Pontprennau
Cardiff
CF23 8ND United Kingdom

Equipment Type: Commercial Audio Power Amplifiers**Family Name:** Macro-Tech**Model Names:** MA-24X6, MA-36X12**EMC Standards:****EN 55103-1:1995** Electromagnetic Compatibility - Product Family Standard for Audio, Video, Audio-Visual and Entertainment Lighting Control Apparatus for Professional Use, Part 1: Emissions**EN 55103-1:1995** Magnetic Field Emissions-Annex A @ 10 cm and 1 M**EN 61000-3-2:1995+A14:2000** Limits for Harmonic Current Emissions (equipment input current $\leq 16A$ per phase)**EN 61000-3-3:1995** Limitation of Voltage Fluctuations and Flicker in Low-Voltage Supply Systems Rated Current $\leq 16A$ **EN 55022:1992 + A1: 1995 & A2:1997** Limits and Methods of Measurement of Radio Disturbance Characteristics of ITE: Radiated, Class B Limits; Conducted, Class B**EN 55103-2:1996** Electromagnetic Compatibility - Product Family Standard for Audio, Video, Audio-Visual and Entertainment Lighting Control Apparatus for Professional Use, Part 2: Immunity**EN 61000-4-2:1995** Electrostatic Discharge Immunity (Environment E2-Criteria B, 4k V Contact, 8k V Air Discharge)**EN 61000-4-3:1996** Radiated, Radio-Frequency, Electromagnetic Immunity (Environment E2, criteria A)**EN 61000-4-4:1995** Electrical Fast Transient/Burst Immunity (Criteria B)**EN 61000-4-5:1995** Surge Immunity (Criteria B)**EN 61000-4-6:1996** Immunity to Conducted Disturbances Induced by Radio-Frequency Fields (Criteria A)**EN 61000-4-11:1994** Voltage Dips, Short Interruptions and Voltage Variation**Safety Standard:****EN 60065: 1998** Safety Requirements - Audio Video and Similar Electronic Apparatus

I certify that the product identified above conforms to the requirements of the EMC Council Directive 89/336/EEC as amended by 92/31/EEC, and the Low Voltage Directive 73/23/EES as amended by 93/68/EEC.

Signed

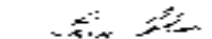

Larry Coburn

Title: Senior Vice President of Manufacturing

Date of Issue: March 28, 2000

Table of Contents

Important Safety Instructions	2	4.1.4 Transformer Thermal Protection	15
Declaration of Conformity	3	4.1.5 Circuit Breakers	15
1 Welcome	5	4.2 Circuit Designs	15
1.1 Features	5	4.2.1 Grounded Bridge	15
1.2 How to Use This Manual	5	4.2.2 Variable Impedance (VZ)	15
2 Setup	6	4.3.1 PIP Modules	16
2.1 Unpack Your Amplifier	6	4.3.2 IQ-PIP-USP2 Adapter	16
2.2 Install Your Amplifier	6	4.3.3 Input Sensitivity Switch	16
2.3 Ensure Proper Cooling	6	4.3.4 Input Ground Lift Switch	16
2.4 Choose Input Wire and Connectors	7	5 Troubleshooting	17
2.5 Choose Output Wire and Connectors	8	5.1 Indicators	17
2.6 Wire Your System	9	6 Theory of Operation	19
2.7 Connect to AC Mains	10	7 Specifications	21
2.8 Startup Procedure	10	8 AC Power Draw and Thermal Dissipation	24
3 Operation	11	9 Service	26
3.1 Precautions	11	9.1 Worldwide Service	26
3.2 Front Panel Controls and Indicators	12	9.2 US and Canada Service	26
3.3 Back Panel Controls and Connectors	13	9.2.1 Service at a US or Canada Service Center	26
4 Advanced Features and Options	14	9.2.2 Factory Service	26
4.1 Protection Systems	14	9.2.3 Factory Service Shipping Instructions:	26
4.1.1 Output Device Emulation Protection (ODEP)	14	10 Warranty	27
4.1.2 IOC (Input Output Comparator)	14	Crown Factory Service Information Form	29
4.1.3 Standby Mode	14		

MA-24x6	*1 kHz Power
Channel 1 (2400)	
2-ohm	1,050W
4-ohm	800W
8-ohm	520W
Channel 2 (600)	
2-ohm	400W
4-ohm	325W
8-ohm	225W
*1 kHz Power: refers to maximum average power in watts at 1 kHz with 0.1% THD.	

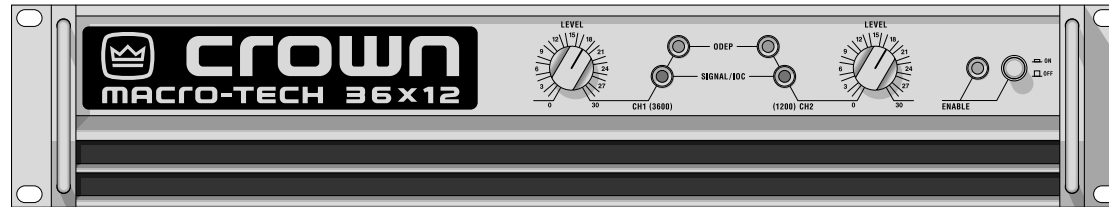

MA-36x12	*1 kHz Power
Channel 1 (3600)	
2-ohm	1,800W
4-ohm	1,565W
8-ohm	1,120W
Channel 2 (1200)	
2-ohm	675W
4-ohm	480W
8-ohm	310W
*1 kHz Power: refers to maximum average power in watts at 1 kHz with 0.1% THD.	

1 Welcome

Congratulations on your purchase of a *Macro-Tech*® dual level professional power amplifier. Your amplifier has a separate high-power and medium-power channel, making it ideal for bi-amplified systems. The Macro-Tech 24x6 combines one channel of a Macro-Tech 2400 with one channel of a Macro-Tech 600. The Macro-Tech 36x12 combines one channel of a Macro-Tech 3600VZ with one channel of a Macro-Tech 1200. And because each model has a separate power supply for each channel, each channel can be treated as a separate power amplifier.

Because it's a Macro-Tech, you have the added benefit of *PIP*™ compatibility for access to custom input modules and *ODEP*® protection to keep the show going long after other amplifiers would fail.

Modern power amplifiers are sophisticated pieces of engineering capable of producing extremely high power levels. They must be treated with respect and correctly installed if they are to provide the many years of reliable service for which they were designed.

In addition, MA-24X6 and MA-36X12 amplifiers include a number of features which require some explanation before they can be used to their maximum advantage.

Please take the time to study this manual so that you can obtain the best possible service from your amplifier.

1.1 Features

- Crown's *Grounded Bridge*™ design delivers incredible voltage swings without using stressful output transistor configurations like conventional amplifiers. The results are lower distortion and superior reliability.
- Patented *ODEP* (Output Device Emulation Protection) circuitry compensates for overheating and overload to keep the amplifier working long after others would fail.
- *IOC*® (Input/Output Comparator) circuitry immediately alerts of any distortion exceeding 0.05%, providing dynamic proof of distortion-free performance.
- *PIP* connector accepts accessories that tailor the amplifier to suit specific applications.
- Very low harmonic and intermodulation distortion give the best dynamic transfer function in the industry.
- High damping factor provides superior control over low frequency drivers for a clean, accurate low end.
- Full protection against shorted outputs, open circuits, DC, mismatched loads, general overheating, high frequency overloads and internal faults.
- Extra rugged, extruded aluminum front panel with *ODEP* and *Signal Presence/IOC* indicators for each channel, as well as an *Enable* indicator.
- Macro-Tech 36x12: Articulated VZ power supply for Channel 1 (3600) provides the best power matching to your load.
- Efficient heat sinks and forced air cooling prevent overheating and prolong component life.
- Balanced inputs with three-position sensitivity switch and adjustable front panel level controls.
- 5-way binding post outputs provide versatile connection.
- Mounts in a standard 19-inch (48.3-cm) equipment rack (units can also be stacked).
- Three Year "No-Fault" Full Warranty completely protects your investment and guarantees its specifications.

1.2 How to Use This Manual

This manual provides you with the necessary information to safely and correctly setup and operate your amplifier. It does not cover every aspect of installation, setup or operation that might occur under every condition. For additional information, please consult Crown's *Amplifier Application Guide* (available online at www.crownaudio.com), Crown Tech Support, your system installer or retailer.

We strongly recommend you read all instructions, warnings and cautions contained in this manual. Also, for your protection, please send in your warranty registration card today. And save your bill of sale—it's your official proof of purchase.

2 Setup

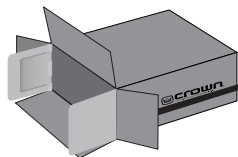

2.1 Unpack Your Amplifier

Please unpack and inspect your amplifier for any damage that may have occurred during transit. If damage is found, notify the transportation company immediately. Only you can initiate a claim for shipping damage. Crown will be happy to help as needed. Save the shipping carton as evidence of damage for the shipper's inspection.

We also recommend that you save all packing materials so you will have them if you ever need to transport the unit. Never ship the unit without the factory pack. **YOU WILL NEED** (not supplied):

- Input wiring cables
- Output wiring cables

Rack for mounting amplifier (or a stable surface for stacking)



WARNING: Before you start to set up your amplifier, make sure you read and observe the Important Safety Instructions found at the beginning of this manual.



2.2 Install Your Amplifier

CAUTION: Before you begin, make sure your amplifier is disconnected from the power source, with power switch in the "off" position and all level controls turned completely down (counterclockwise).

Use a standard 19-inch (48.3 cm) equipment rack. See Figure 2.1 for amplifier dimensions.

You may also stack amps without using a cabinet.

NOTE: When transporting, amplifiers should be supported at both front and back.

2.3 Ensure Proper Cooling

When using an equipment rack, mount units directly on top of each other. Close any open spaces in rack with blank panels. **DO NOT** block front or rear air vents. The side walls of the rack should be a minimum of two inches (5.1 cm) away from the amplifier sides, and the back of the rack should be a minimum of four inches (10.2 cm) from the amplifier back panel.

Figure 2.2 illustrates standard amplifier airflow.

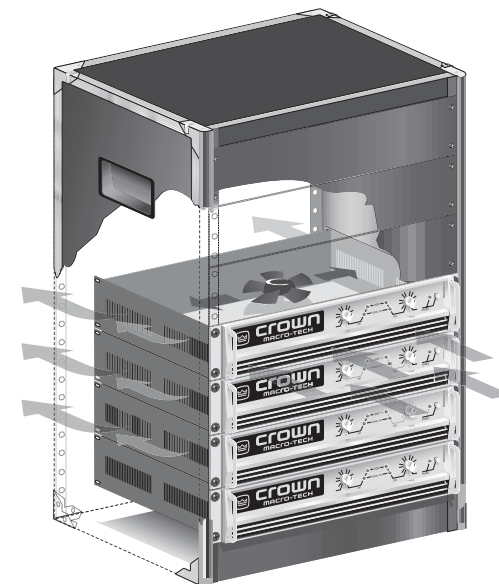

Figure 2.2 Airflow

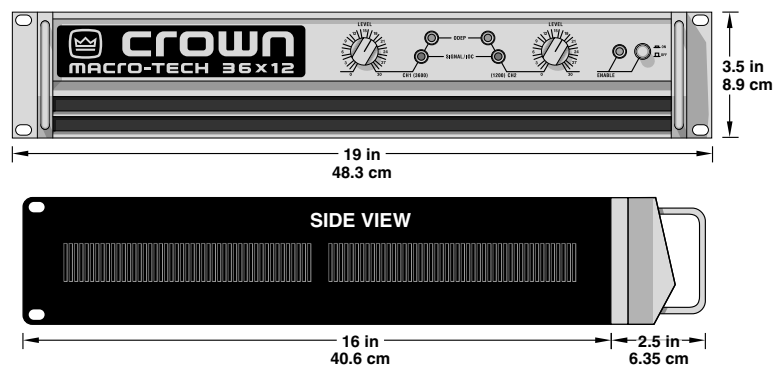

Figure 2.1 Dimensions

2 Setup

2.4 Choose Input Wire and Connectors

Figure 2.3 shows connector pin assignments for balanced wiring, and Figure 2.4 shows connector pin assignments for unbalanced wiring.



NOTE: Custom wiring should only be performed by qualified personnel.

Balanced Line

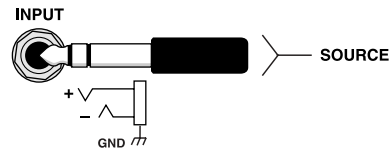
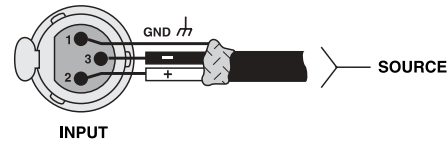

Figure 2.3 Balanced Input Connector Wiring

Unbalanced Line

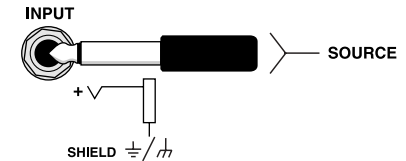
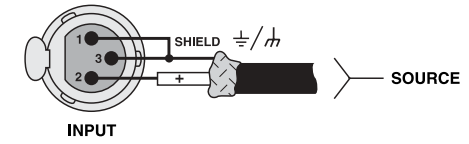

Figure 2.4 Unbalanced Input Connector Wiring

2 Setup

2.5 Choose Output Wire and Connectors

Crown recommends using pre-built or professionally wired, high-quality, two-conductor, heavy gauge speaker wire and connectors. You may use banana connectors, terminal forks or bare wire for your output connectors (see Figure 2.5). To prevent the possibility of short-circuits, wrap or otherwise insulate exposed loudspeaker cable connectors.



Note: Binding post outputs on European models come with safety plugs installed to prevent European power-cord plugs from being inserted. The side entry positions for these connectors should therefore be used on European models.

Using the guidelines below, select the appropriate size of wire based on the distance from amplifier to speaker.

Distance	Wire Size
up to 25 ft.	16 AWG
26-40 ft.	14 AWG
41-60 ft.	12 AWG
61-100 ft.	10 AWG
101-150 ft.	8 AWG
151-250 ft.	6 AWG



CAUTION: Never use shielded cable for output wiring.

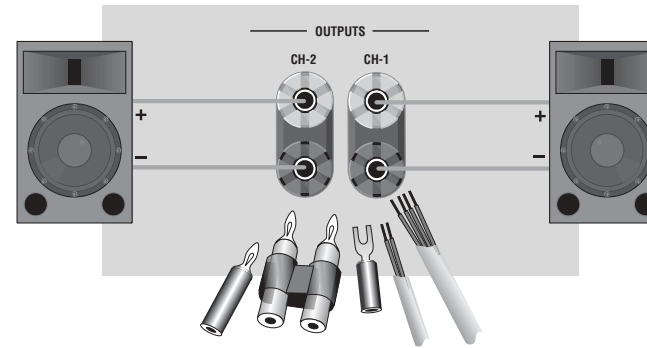

Figure 2.5 Output Connector Wiring

2 Setup

2.6 Wire Your System

This section describes the most common way to install the Macro-Tech 24X6 and 36X12. Each model is designed for bi-amplified systems and includes both a high-power and a medium-power channel.

Because each channel produces a different power level, the Macro-Tech 24x6 and 36x12 are dedicated to two-channel operation. They do NOT offer mono operation.



WARNING: Never strap the outputs together for Parallel-Mono operation! Never bridge the outputs for Bridge-Mono operation!

Installation of the Macro-Tech 24x6 and 36x12 is very intuitive. The Channel 1 input feeds the Channel 1 output and the Channel 2 input feeds the Channel 2 output. Be sure to connect the output wiring as shown in Figure 2.6.

Five-way binding posts are provided to facilitate easy connection of loudspeakers to each channel. Note: Because of its higher output power, Channel 1 of a Macro-Tech 36x12 has an additional set of binding posts.

Observe correct loudspeaker polarity and be very careful not to short the outputs of one channel to the outputs of the other channel.

NOTE: Crown provides a reference of wiring pin assignments for commonly used connector types in the Crown *Amplifier Application Guide* available at www.crownaudio.com.

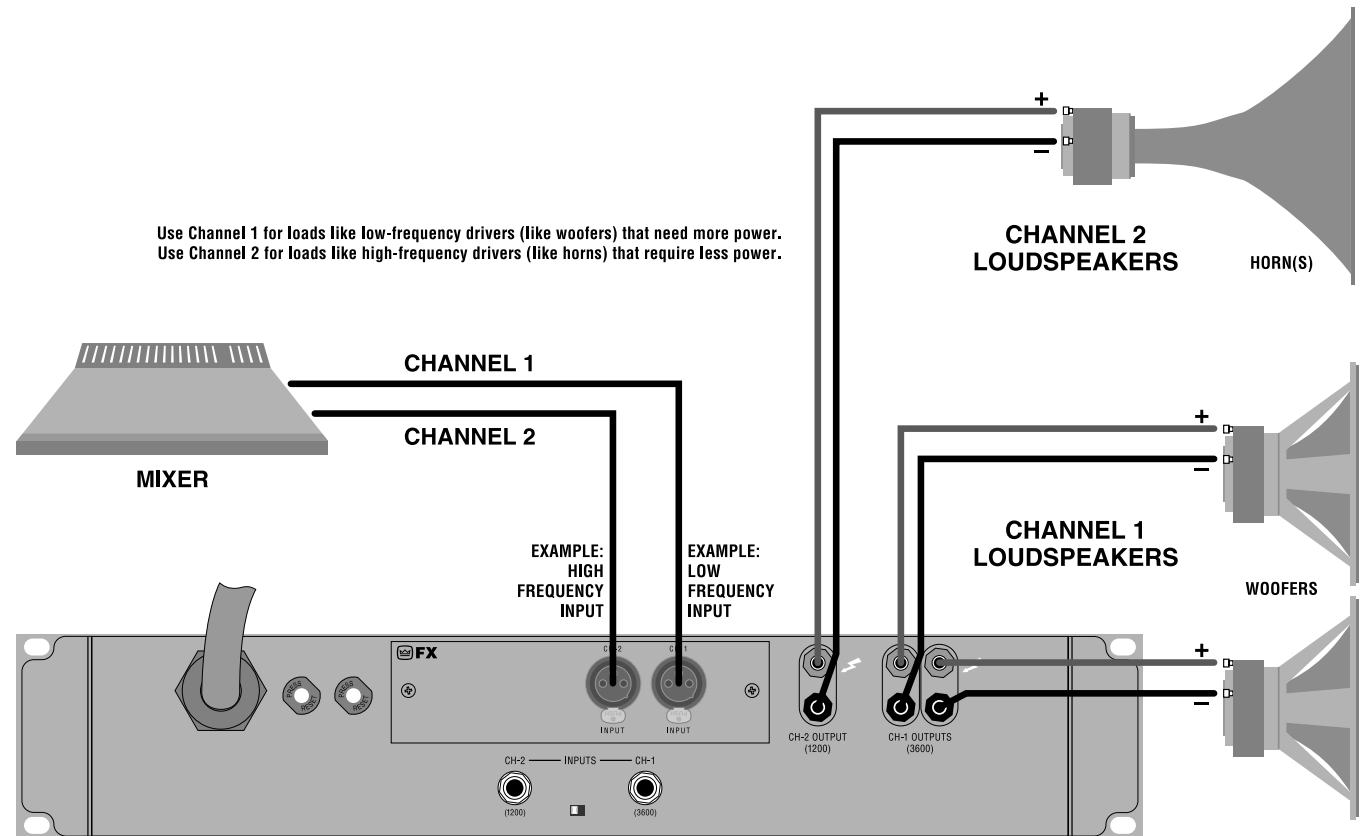

Figure 2.6 System Wiring (a Macro-Tech 36x12 is shown)

2 Setup

2.7 Connect to AC Mains

Connect the AC power cordset of your amplifier to the AC mains power source (power outlet).

NOTE: The third prong of this connector (ground) is an important safety feature. Do not attempt to disable this ground connection by using an adapter or other methods.

Amplifiers don't create energy. The AC mains voltage and current must be sufficient to deliver the power you expect. You must operate your amplifier from an AC mains power source with not more than 10% variation above or below the amplifier's specified line voltage and within the specified frequency requirements (indicated on the amplifier's back panel label). If you are unsure of the output voltage of your AC mains, please consult your electrician.

2.8 Startup Procedure

Use the following procedure when first turning on your amplifier:

1. Turn down the level of your audio source.
2. Turn down the level controls of the amplifier.
3. Turn on the "Enable" switch. The Enable indicator should glow.
4. Turn up the level of your audio source to an optimum level.
5. Turn up the Level controls on the amplifier until the desired loudness or power level is achieved.
6. Turn down the level of your audio source to its normal range.

If you ever need to make any wiring or installation changes, don't forget to turn off the amplifier and disconnect the power cord.

For help with determining your system's optimum gain structure (signal levels) please refer to the Crown *Amplifier Application Guide*, available online at www.crownaudio.com.

3 Operation

3.1 Precautions

Your Macro-Tech Series amplifier is protected from internal and external faults, but you should still take the following precautions for optimum performance and safety:

1. Before use, your amplifier first must be configured for proper operation, including input and output wiring hookup. Improper wiring can result in serious operating difficulties. For information on wiring and configuration, please consult the Setup section of this manual or, for advanced setup techniques, consult Crown's *Amplifier Application Guide* available online at www.crownaudio.com.
2. Use care when making connections, selecting signal sources and controlling the output level. The load you save may be your own!
3. Do not short the ground lead of an output cable to the input signal ground. This may form a ground loop and cause oscillations.
4. **Never connect the output to a power supply, battery or power main. Electrical shock may result.**
5. Tampering with the circuitry, or making unauthorized circuit changes, may be hazardous and invalidates all agency listings.
6. Do not operate the amplifier with the Signal/IOC LEDs constantly indicating an IOC condition.
7. Do not overdrive the mixer, which will cause a clipped signal to be sent to the amplifier. Such signals will be reproduced with extreme accuracy, and loudspeaker damage may result.



3 Operation

3.2 Front Panel Controls and Indicators

A. Dust Filter

Removes large particles from the air at the air intake. The filter elements can be easily removed for cleaning by gently pulling them away from the front panel.

B. Level Control

Rotary detented level control, one per channel.

C. Signal/IOC Indicator

Green LED, one per channel. Dual-purpose indicator illuminates to indicate the presence of input signals; flashes brightly with a 0.1-second hold delay to indicate a difference (distortion) between the input and output signal of 0.05% or greater; and flashes brightly with a 0.5-second hold delay to indicate input clipping distortion. See Section 4.1.2 for more about IOC.

D. ODEP Indicator

Red LED, one per channel, illuminates brightly to indicate presence of thermody-

amic energy. They dim proportionally as energy reserves decrease. In the event that energy reserves are depleted, the indicators turn off and ODEP limiting occurs. See Section 4.1 for more about ODEP.

E. Enable Indicator

Green LED indicates amplifier has been turned on and AC power is available.

F. Enable Switch

Amplifier is on when the switch is in the IN position.

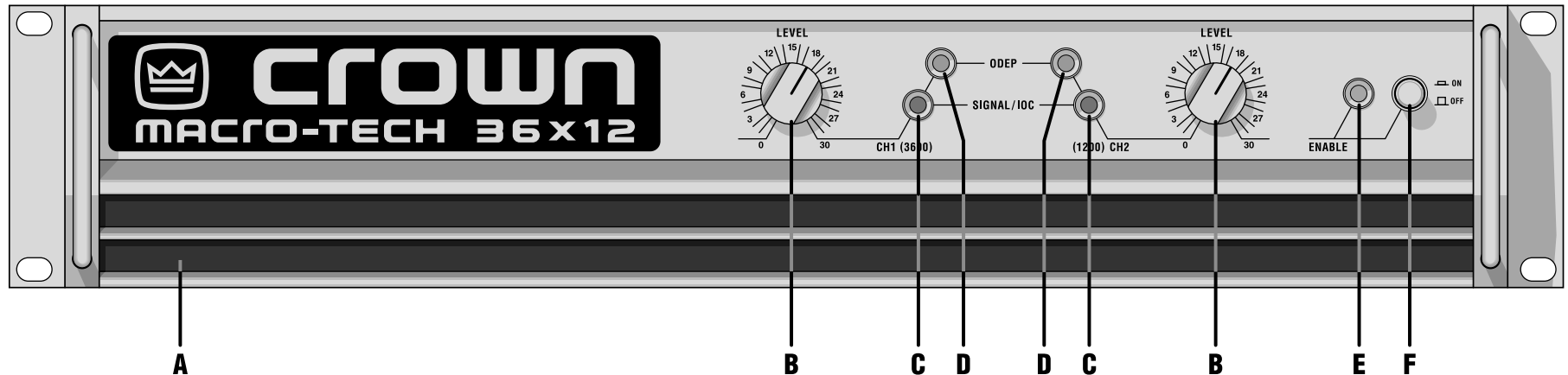

Figure 3.1 Front Panel Controls and Indicators

3 Operation

3.3 Back Panel Controls and Connectors

G. Power Cord

120 VAC, 60 Hz units have a 20-amp (12 AWG) line cord with a grounded NEMA 5-15P plug. See Section 8 for AC power usage.

H. Reset Switches

The reset switches are used to reset the breakers that safeguard each power supply from overload.

I. PIP Module

The standard P.I.P.-FX is included with your amplifier. It provides female XLR input connectors. A variety of other PIP modules can be

used in place of the P.I.P.-FX. They add additional features that customize the amplifier for different applications. For information on available PIP modules visit the Crown website at <http://www.crownaudio.com>.

Input Sensitivity Switch

The three-position input sensitivity switch located inside the amplifier is accessed by removing the PIP module (I). It is factory-set to 0.775 volts for rated 8 ohm output. It can also be set to 1.4 volts for rated output, or a voltage gain of 26 dB (see Section 4.3.3).

J. Balanced Phone Jack Inputs

Balanced 1/4-inch phone jack input connectors are provided on the back panel of your amplifier. The phone jacks can be wired for either

balanced (tip, ring and sleeve) or unbalanced (tip and sleeve) input signals. Because they are electrically in parallel with the PIP input connectors, input signals should not be connected to the phone jacks when certain PIP modules are installed (see the Crown *Amplifier Application Guide* available online at www.crownaudio.com). The phone jacks can also be used as "daisy chain" outputs to simplify connecting input signals to multiple amplifiers.

K. Ground Lift Switch

This switch isolates or "lifts" the phone jack signal grounds from the AC power ground. Activating the switch inserts an impedance between the sleeve of each phone jack and the unit's AC ground to help prevent the hum that can result from a ground loop.

L. Balanced XLR Inputs

The factory-installed P.I.P.-FX provides a three-pin female XLR connector for balanced input to each channel. The XLR inputs are connected in parallel with the amplifier's phone jack inputs. Because the P.I.P.-FX does not have any active circuitry, its XLR connectors can also be used as "daisy chain" outputs to connect signals from phone jack inputs to multiple amplifiers.

M. Output Jacks

A pair of versatile 5-way binding posts is provided for the output of each channel. The 5-way binding posts accept banana plugs, spade lugs or bare wire. *Note: Because of its higher output power, the Macro-Tech 36x12 has an additional set of binding posts.*

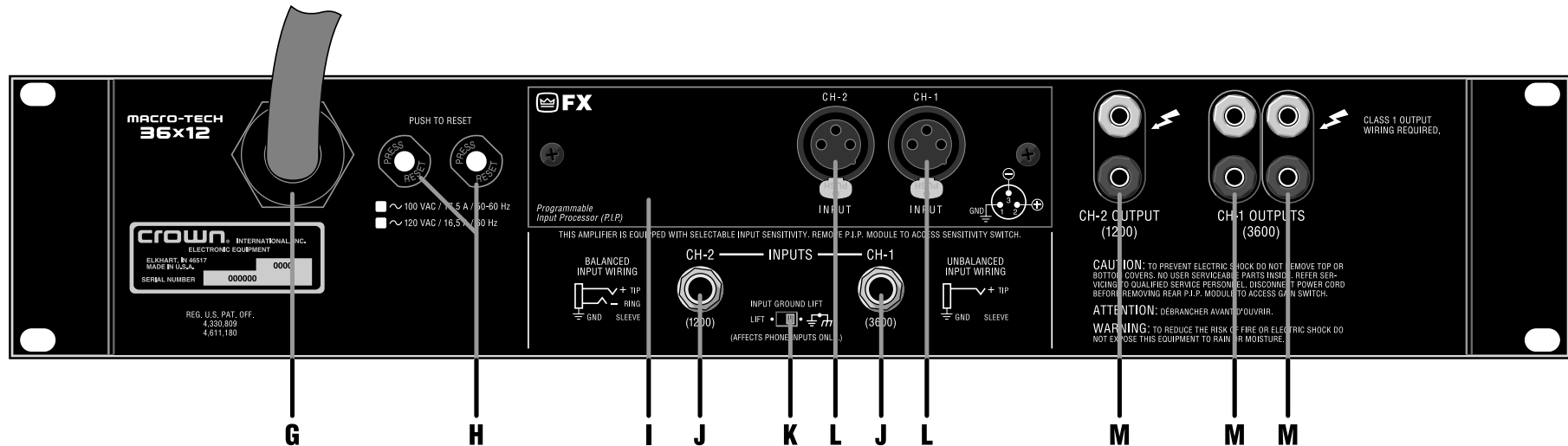

Figure 3.2 Back Panel Controls and Connectors

4 Advanced Features and Options

NOTE: For detailed information about these Crown amplifier features, please consult the Crown *Amplifier Application Guide*, available on the Crown website at www.crownaudio.com

4.1 Protection Systems

Your Crown amplifier provides extensive protection and diagnostic capabilities, including ODEP, IOC, “standby” mode, fuses (or breakers), and special thermal protection for the unit’s transformers.

4.1.1 Output Device Emulation Protection (ODEP)

Crown invented ODEP to solve two long standing problems in amplifier design: To prevent amplifier shutdown during demanding operation and to increase the efficiency of output circuitry.

To do this, Crown established a rigorous program to measure the safe operating area (SOA) of each output transistor before installing it in an amplifier. Crown also designed intelligent circuitry to simulate the instantaneous operating conditions of those output transistors. Its name describes what it does: Output Device Emulation Protection or ODEP. It not only simulates the operation of the output transistors but it also compares their operation to their known SOA. If ODEP sees that more power is about to be asked of the output devices than they are capable of delivering under the present conditions, ODEP immediately limits the drive level until it falls within the SOA. Limiting is proportional and kept to an absolute minimum—only what is required to prevent the possibility of output transistor damage.

This level of protection enables Crown to increase output transistor utilization while greatly increasing amplifier reliability.

Finally, this onboard intelligence is monitored in two ways. First, the front panel ODEP indicators show whether the amplifier is functioning correctly or if ODEP is limiting the drive level. Second, ODEP data is fed to the PIP connector at the back of the amplifier so advanced PIP modules like the IQ-PIP-USP2 can use it to make decisions and control the amplifier.

With ODEP you get the maximum power with the maximum protection—the show goes on!

4.1.2 IOC (Input Output Comparator)

The IOC circuit compares the output signal of the amplifier with the input signal. If there is any difference other than gain, then it is considered distortion and the indicator comes on. The LED indicator will come on whenever there is distortion of 0.05% or more. An IOC condition may also be sensed by an IQ PIP module installed in PIP-compatible amplifiers.

IOC is designed to report any form of distortion. IOC not only checks the waveform for distortion, but also reports input overload and even a protective action that mutes or shuts down an amplifier. With all of these features, IOC monitors the entire amplifier. When the IOC indicator is off the amplifier is definitely operational and undistorted. IOC provides an on-line proof of performance.

4.1.3 Standby Mode

At the heart of the protection systems is the standby mode which removes power from the

high-voltage supplies to protect the amplifier and connected loads. The standby mode can be identified using the indicator table in Figure 5.2.

Standby mode can be activated in several situations. First, if dangerous subsonic frequencies or direct current (DC) is detected in the amplifier’s output, the unit will activate its DC/low-frequency protection circuitry and put the affected channels in standby. This protects the loads and prevent oscillations. The unit resumes normal operation as soon as the amplifier no longer detects dangerous low frequency or DC output. Although it is extremely unlikely that you will ever activate the amplifier’s DC/low-frequency protection system, improper source materials such as subsonic square waves or input overloads that result in excessively clipped input signals can activate this system.

The amplifier’s fault protection system will put an amplifier channel in standby mode in rare situations where heavy common-mode current is detected in the channel’s output. The amplifier should never output heavy common-mode current unless its circuitry is damaged in some way, and putting a channel in standby mode helps to prevent further damage.

The amplifier’s transformer thermal protection circuitry is activated in very unusual circumstances where the unit’s transformer temperature rises to unsafe levels. Under these abnormal conditions, the amplifier will put the channel of the affected transformer in standby mode. The amplifier will return to normal operation after the transformer cools to a safe temperature. (For more information on transformer thermal protection, refer to the following section.)

4 Advanced Features and Options

4.1.4 Transformer Thermal Protection

All Macro-Tech amplifiers have transformer thermal protection. It protects the power supplies from damage under the rare conditions of transformer temperatures rising too high. A thermal switch embedded in each transformer removes power to the channel if there is excessive heat. The switch automatically resets when the transformer cools to a safe temperature.

It is very unlikely that you will ever see a Macro-Tech amplifier activate transformer thermal protection as long as it is operated within rated conditions (see Section 7, Specifications). One reason is that ODEP keeps the amplifier working under very severe conditions. Even so, higher than rated output levels, excessively low impedance loads and unreasonably high input signals can generate more heat in the transformer than in the output devices. These conditions can overheat the transformer and activate its protection system.

Macro-Tech amplifiers are designed to keep working under conditions where other amplifiers would fail. But even when its limits are exceeded, it will still protect itself—and your investment—from damage.

4.1.5 Circuit Breakers

The power supplies are protected by circuit breakers. With rated loads and output levels, the circuit breakers should only shut down the amplifier in the rare instance of a catastrophic failure. Other protection systems like ODEP keep the amplifier operational under most other severe conditions. The circuit breakers can also shut down the amplifier in cases where extremely low-impedance loads and high output levels result in current draw that exceeds their rating. Again, this should only be possible when operating outside rated conditions, like

when the amplifier is used to drive a 1-ohm load in Stereo mode, or when a signal overloads the input and is clipped severely.

Macro-Tech amplifiers do not trip their breakers unless something is wrong. If a breaker trips, try to identify and correct the problem before resetting the breakers with the back panel Reset switches. If the problem persists, refer the unit to a qualified technician.

4.2 Circuit Designs

4.2.1 Grounded Bridge

Grounded Bridge is the name of Crown's unique four-quadrant amplifier topology. The Grounded Bridge topology takes full advantage of the power supplies delivering peak-to-peak voltages to the load that are twice the voltage seen by the output devices and twice the voltage generated by the power supplies.

The power supply bridge rectifier is not ground referenced, and the transformer secondary is not center-tapped. This allows the power supply to deliver +VCC and -VCC from the same bridge rectifier and filter as a total difference in potential regardless of their voltages with respect to ground.

Composite output devices are arranged to function as gigantic NPN and PNP devices. Each output stage has two composite NPN and two composite PNP devices. The devices connected to the load are referred to as "high-side NPN and PNP" and the devices connected to ground are referred to as "low-side NPN and PNP." Positive current is delivered to the load by increasing conductance simultaneously in the high-side NPN and low-side PNP stage, while decreasing conductance of the high-side PNP and low-side NPN in synchrony.

Crown's Grounded Bridge design delivers large voltage swings without stressing output transistors. The results are higher efficiency, lower distortion and superior reliability.

4.2.2 Variable Impedance (VZ) (Macro-Tech 36X12 only)

VZ is the name of Crown's patented articulated power supply technology. This innovative technology permits us to pack large amounts of power into a compact package while achieving ultra-low distortion and without generating excessive heat.

An amplifier power supply must be large enough to handle both the maximum voltage and maximum current necessary for the amplifier to drive its rated power into a specified load. In order to meet this requirement, most conventional supplies are heavy, large, and produce lots of heat. In contrast, the VZ supply gets more current AND voltage out of a smaller, lighter, and more efficient package by dynamically adapting to both signal and load requirements in real-time. This provides the best power match to the widest range of loads.

The VZ supply is divided into two segments. When the output stage requires high-voltage, the segments are arranged in series to deliver twice the voltage of a single segment. When the output stage requires high-current, the segments are arranged in parallel to deliver twice the current of a single segment. Sensing circuitry "watches" the voltage of the signal to determine when to switch VZ modes. The switching circuitry is designed to prevent audible switching distortion to yield the highest possible dynamic transfer function—you hear only the music and not the amplifier.

With VZ, you get not only maximum power and safety, but you also get the best power matching to your load.

4 Advanced Features and Options

4.3 Options

4.3.1 PIP Modules

Versatile PIP (Programmable Input Processor) modules provide flexible expansion features that can be added to customize the amplifier. PIP modules plug into the connector inside the back panel of the amplifier.

PIP modules are available with a features ranging from error-driven compressor/limiters to IQ control. Visit the Crown website at www.crownaudio.com, or contact Crown Technical Support, for descriptions of available PIP modules.

4.3.2 IQ-PIP-USP2 Adapter

The IQ-PIP-USP2 Adapter allows the amplifier to accept the Crown IQ-PIP-USP2 module, which offers remote control and monitoring via Crown's *Smart Amp*™ IQ features set, plus a wide range of digital signal processing capabilities

Features:

- 24-bit, 48-kHz sampling rate for analog to digital conversion.
- Programmable DSP filters.
- Greater than one-half second of signal delay for each channel.
- Input Signal Compressor/Limiter, Thermal Limiter and Clip Eliminator for each channel.
- Presets for easy recall of settings.
- Auto-Standby for reduced energy costs.
- Error reporting.
- Logic input and output.
- Listen Bus allow easy connection to an audio monitoring system.

4.3.3 Input Sensitivity Switch

The Input Sensitivity Switch is located inside the PIP compartment at the back of the amplifier (Figure 4.1). It is set at the factory to 0.775 volt for rated output into 8 ohms. It can also be switched to a sensitivity of 1.4 volts, or a fixed voltage gain of 26 dB (4.8 volts for rated output). At 26 dB voltage gain, the equivalent input sensitivity is:

Macro-Tech 24X6: 3.1V for Channel 1, and 2.2V for Channel 2.

Macro-Tech 36X12: 4.8V for Channel 1, and 2.6V for Channel 2.

How to change the input sensitivity:

1. Turn off the amplifier and disconnect its power cord from the AC mains power receptacle.
2. Remove the PIP module (two screws).
3. Locate the sensitivity switch access hole inside the chassis opening as shown in Figure 4.1. It is located just above the phone jack inputs.
4. Set the switch to the desired position noted on the access hole label. The position toward the front panel sets the sensitivity to 1.4

volts for rated output, the middle position provides a voltage gain of 26 dB, and the position toward the back panel sets the sensitivity to 0.775 volt for rated output.

5. Replace the PIP module and restore the power.

4.3.4 Input Ground Lift Switch

The Input Ground Lift switch is located on the rear panel (Figure 4.1) and can provide isolation between the input signal ground and the AC ground. It affects only the phone jack inputs and has no effect on the input connectors on the PIP module. Sliding the switch to the left isolates or "lifts" the grounds by placing an impedance between the sleeve of each phone jack and the circuit ground.

When a PIP module is plugged into the amplifier, only the noninverted and inverted signal lines are connected in parallel with the corresponding lines of the input phone jacks. The signal grounds are not paralleled. For example, XLR pins 2 and 3 are connected in parallel with the tip and ring of the corresponding phone jack. However pin 1 of the XLR is not connected in parallel with the sleeve of the phone jack.

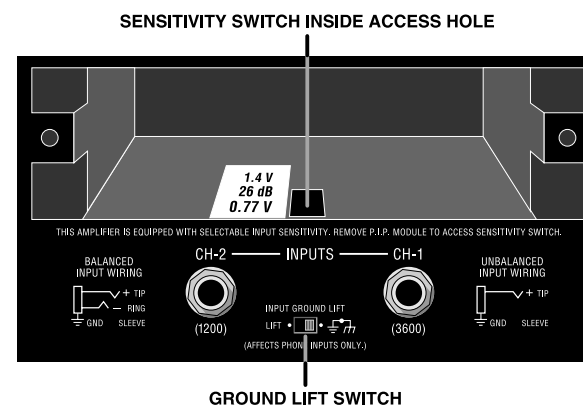

Figure 4.1 Input Sensitivity and Ground Lift Switches

5 Troubleshooting

5.1 Indicators

The front panel has several helpful indicator LEDs (Figure 5.1).

The amber **Enable indicator** is provided to show the amplifier has been turned on (or enabled) and that its low voltage power supply and forced-air cooling system are working. It does not indicate the status of the high voltage supplies. For example, the Enable indicator will remain lit during unusual conditions that would cause the amplifier's protection systems to put a high-voltage supply in "standby" mode (see Section 4.1.3).

The amber **ODEP indicators** confirm the normal operation of Crown's patented Output Device Emulation Protection circuitry. During normal operation, they glow brightly to show the presence of reserve thermal-dynamic energy. They dim proportionally as the energy reserve decreases. In the rare event that there is no reserve, the indicators turn off and ODEP proportionally limits the drive level of the output stages so the amplifier can continue safe

operation even when conditions are severe. (For a more detailed description of ODEP, see Section 4.1.1).

The ODEP indicator for the affected channel will turn off if a high-voltage power supply is put in "standby" mode, a high-voltage power supply fuse (or breaker) blows, or a transformer activates its thermal protection circuitry (see Section 4.1.4). Both ODEP indicators turn off if the amplifier loses AC power, the power switch is turned off or the low-voltage power supply fuse blows.

The green **Signal/IOC indicators** show signal presence, distortion and input overload. As signal presence indicators, they flash with normal intensity in sync with the output audio signals. As IOC (Input/Output Comparator) indicators, they flash brightly if there is any difference between the input and output signal waveforms greater than 0.05%. Because transient distortion happens quickly, a 0.1 second "hold delay" keeps the indicators on long enough to be easily noticed. The IOC function provides proof of distortion-free performance.

As input overload indicators, they flash brightly with a 0.5 second hold delay to show that an input signal is too large and must be clipped at the input.

Under conditions where one of the amplifier's high-voltage power supplies is temporarily put in standby mode, the Signal/IOC indicators will stay on with full brightness. They will resume normal operation when the amplifier is no longer in standby mode.

The table in Figure 5.2 shows the possible states for the ODEP and Signal/IOC indicators. It also describes the conditions that may be associated with the different indicator states. The Enable indicator will be off with the first indicator state, "There is no power to the amplifier." All other conditions in the table will occur with the Enable indicator turned on. It is important to note the possible states of the indicators in the rare event that you experience a problem. This can greatly aid in determining the source of problems. Please contact your local Crown representative or our Technical Support Group for further assistance.

Figure 5.1 Indicators

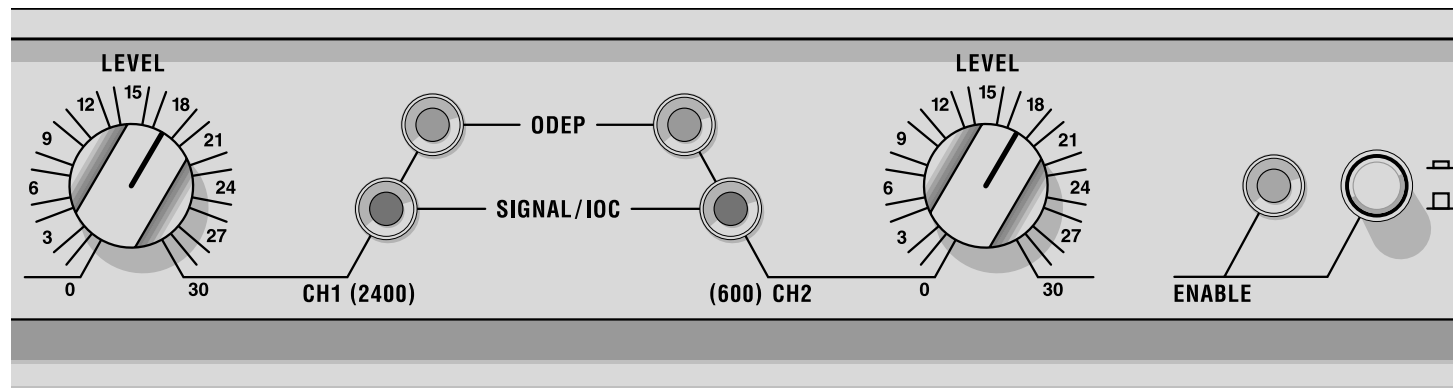

5 Troubleshooting













Indicator Status	Amplifier Condition
ODEP —  OFF SIGNAL/IOC —  OFF	There is no power to the amplifier and all indicators are off, including the Enable light. Possible reasons: (1) The amplifier's Enable switch is off. (2) The amplifier is not plugged into the power receptacle. (3) The AC circuit breaker has been tripped. (4) The amplifier's low-voltage power supply fuse has blown.
ODEP —  ON SIGNAL/IOC —  OFF	Normal operation for a channel with NO audio output. Possible reasons: (1) There is no input signal. (2) The input signal level is very low. (3) The channel's level control is turned down.
ODEP —  ON SIGNAL/IOC —  Normal	Normal operation for a channel with audio output. The <i>ODEP</i> indicator will remain at full intensity to show that there is reserve thermodynamic energy, and the <i>Signal/IOC</i> indicator will flash with normal intensity to show that the channel has audio output.
ODEP —  ON SIGNAL/IOC —  Bright	The channel's output is exceeding 0.05% distortion. The input signal level is too high and <i>IOC</i> is reporting either an input overload or output clipping.
ODEP —  OFF SIGNAL/IOC —  Bright	The amplifier channel is in standby mode. Possible reasons: (1) A PIP module like an <i>IQ-P.I.P.-SMT</i> has turned off the channel's high-voltage power supply. (2) The amplifier has just been turned on and is still in the four second turn-on delay. (3) The DC / low-frequency protection circuitry has been activated. (4) The fault protection circuitry has been activated. (5) The transformer thermal protection circuitry has been activated. OR A channel's circuit breaker has tripped. Transformer overload can cause a channel's circuit breaker to trip. OR ODEP limiting has been activated. Possible reasons: (1) The amplifier's air filters are blocked and need to be cleaned. (2) There is insufficient cooling because of inadequate air flow or air that is too hot. (3) The load impedance for the channel is too low because the output is shorted or the amplifier is driving too many loudspeakers for the selected stereo/mono mode. (4) The amplifier channel is continuously being driven to very high output levels.
ODEP —  OFF SIGNAL/IOC —  Normal	ODEP limiting is about to begin. Possible reasons: (1) The amplifier's air filters are blocked and need to be cleaned. (2) There is insufficient cooling because of inadequate air flow or air that is too hot. (3) The load impedance for the channel is too low because the output is shorted or the amplifier is driving too many loudspeakers for the selected stereo/mono mode. (4) The amplifier channel is continuously being driven to very high output levels.

Figure 5.2
ODEP and Signal/IOC
Indicator States

6 Theory of Operation

Each channel is powered by its own power transformer, T100 or T200. Both channels share TF-1, a low voltage transformer. The secondary outputs of each transformer are full-wave rectified by heavy duty bridge rectifiers and are filtered by large computer grade capacitors. A thermal switch embedded in each transformer protects them from overheating.

The low voltage transformer TF-1 uses a separate fan motor winding. The TF-1 output is rectified by diodes D1-4, generates an unregulated 24 volts. Monolithic regulators U1-2 provide a regulated ± 15 volts.

For simplicity, the following discussion of the circuitry and operation will refer to one channel only. Please refer to the block diagram in Figure 6.1

The input signal at the phone jack passes directly into the balanced gain stage (U104-C,D). Use of a PIP module for input signal causes the input signal to pass through the PIP and then to the balanced gain stage.

The balanced gain stage (U104-C,D) causes balanced to single-ended conversion to take place using a difference amplifier. From there, gain can be controlled with a potentiometer. The error amp (U104-A) amplifies the difference between the output signal and the input signal from the gain pot, and drives the voltage translator stage.

The voltage translator stage channels the signal to the Last Voltage Amplifiers (LVAs), depending on the signal polarity, from the error amp U104-A. The +LVA (Q105,Q125) and the -LVA (Q110,Q126), with their push-pull effect through the bias servo Q318, drive the fully complementary output stage.

The bias servo Q318 is thermally coupled to the heat sink, and sets the quiescent bias current in the output stage to lower the distortion in the crossover region of the output signal. D301, D302, D303, and D304 are used to remove the charge on the unused portion of the output stage, depending on the polarity of the output signal.

With the voltage swing provided by the LVAs, the signal then gains current amplification through the Darlington emitter-follower output stage.

The bridge-balanced circuit (U104-B) receives a signal from the output of the amplifier, and differences it with the signal at the Vcc supply. The bridge-balanced circuit then develops a voltage to drive the bridge-balanced output stage. This results in the Vcc supply having exactly one half of the output voltage added to their quiescent voltage. D309, D310, D311 and a trimmer resistor set the quiescent current point for the bridge-balanced output stage.

The protection mechanisms that affect the signal path are implemented to protect the amplifier under real-world conditions. These conditions are high instantaneous current, excessive temperature, and operation of the output devices outside safe conditions.

Q107 and Q108 act as a conventional current limiter, sensing current in the output stage. The allowable current level is also adjusted as a function of voltage. When current at any one instant exceeds the design criteria, the limiters remove the drive from the LVAs, thus limiting current in the output stage to a safe level.

To further protect the output stages, a specially developed ODEP (Output Device Emulation Protection) circuit is used. It produces an analog output proportional to the always changing safe operating area of the output transistors. This output controls the translator stage by removing any drive that exceeds the safe operating area of the output devices. Thermal sensor S100 gives the ODEP circuits vital information on the operating temperature of the heatsink on which the output devices are mounted.

Should the amplifier fail in such a way that would cause DC across the output lead, the DC protection circuit senses this on the negative feedback loop and shuts down the power supply until the DC is removed.

6 Theory of Operation

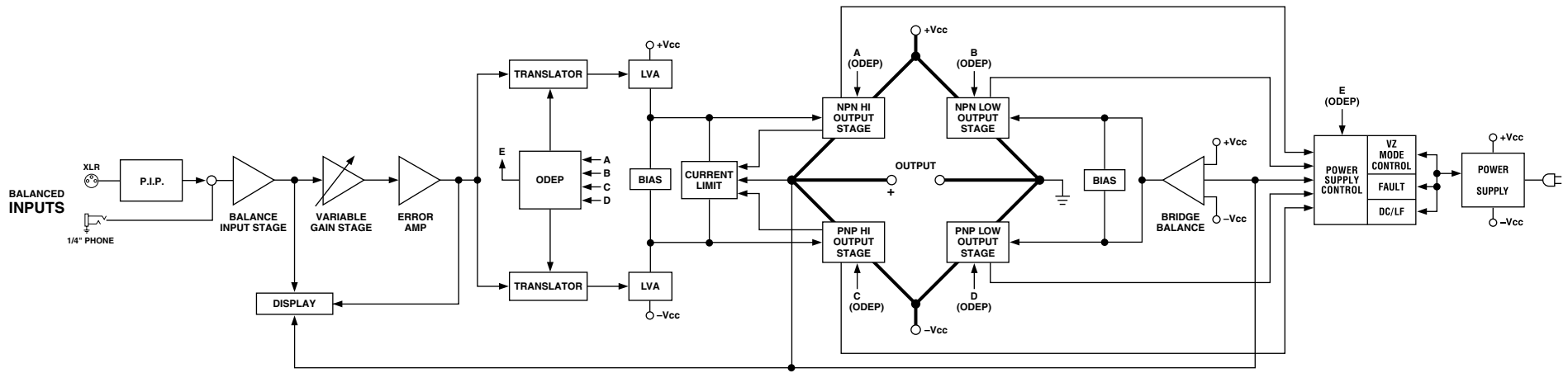

ONLY ONE CHANNEL SHOWN

Figure 6.1 Circuit Block Diagram (Channel 1)

7 Specifications

Minimum Guaranteed Power	120VAC, 60 Hz Units		International Units	
	Macro-Tech 24X6	Macro-Tech 36X12	Macro-Tech 24X6	Macro-Tech 36X12
Power in watts per channel, 1 kHz, 0.1% THD				
Channel 1				
2 ohms per ch.	1050W	1800W	875W	1460W
4 ohms per ch.	800W	1565W	745W	1300W
8 ohms per ch.	520W	1120W	510W	965W
Channel 2				
2 ohms per ch.	400W	675W	375W	515W
4 ohms per ch.	325W	480W	335W	420W
8 ohms per ch.	225W	310W	230W	285W
Performance (120V AC units in stereo mode with 8 ohm load)				
Frequency Response				
(at 1 watt, 20Hz - 20 kHz) see Figure 7.1.	± 0.1 dB	± 0.1 dB		
Phase Response				
(at 1 watt, 10Hz - 20 kHz) see Figure 7.4.	±10°	±10°		
Signal to Noise Ratio below full bandwidth power				
20 Hz to 20 kHz	>100 dB	>100 dB		
A-weighted	>105 dB	>105 dB		
Total Harmonic Distortion (THD)				
at rated power, from 20 Hz to 1 kHz	< 0.05%	< 0.05%		
at rated power, at 20 kHz	< 0.1%	< 0.1%		
Intermodulation Distortion (IMD)				
60 Hz and 7 kHz at 4:1, from 10 milliwatts to full rated output	< 0.05%	< 0.05%		
Damping Factor				
10 Hz to 400 Hz See Figure 7.2.	>1000	>1000		
Crosstalk				
(below rated power, 20 Hz to 1 kHz)	see Figure 7.5	see Figure 7.5		
Controlled Slew Rate				
Channel 1	> 30V per microsecond	> 30V per microsecond		
Channel 2	> 13V per microsecond	> 13V per microsecond		
Input Impedance (nominally balanced, nominally unbalanced)				
	20 k ohms, 10 k ohms	20 k ohms, 10 k ohms		

7 Specifications

Performance (continued)	Macro-Tech 24X6	Macro-Tech 36X12
Output Impedance	See Figure 7.3	See Figure 7.3
Load Impedance (Note: Safe with all types of loads)	2, 4, 8, 16 ohms	2, 4, 8, 16 ohms
Voltage Gain (8-ohm load, rated output at 1 kHz, maximum level setting)	83:1 ±6% or 38 dB ±0.5 dB (Ch. 1, .775V sensitivity) 54:1 ±6% or 35 dB ±0.5 dB (Ch. 2, .775V sensitivity) 20:1 ±6% or 26 dB ±0.5 dB (Ch. 1, 26 dB gain) 20:1 ±6% or 26 dB ±0.5 dB (Ch. 2, 26 dB gain)	124.6:1 ±6% or 42 dB ±0.5 dB (Ch. 1, .775V sensitivity) 64:1 ±6% or 36 dB ±0.5 dB (Ch. 2, .775V sensitivity) 20:1 ±6% or 26 dB ±0.5 dB (Ch. 1, 26 dB gain) 20:1 ±6% or 26 dB ±0.5 dB (Ch. 2, 26 dB gain)
Required AC Mains	50/60 Hz; 100-, 120-, and 230 - VAC (±10%) units are available. 230 VAC, 50/60 Hz units can be used with 220 and 240 VAC. Current, voltage and frequency requirements are provided on the unit's back panel.	50/60 Hz; 100-, 120-, and 230 - VAC (±10%) units are available. 230 VAC, 50/60 Hz units can be used with 220 and 240 VAC. Current, voltage and frequency requirements are provided on the unit's back panel.
Power Draw at Idle	90 watts or less	90 watts or less
Construction	Macro-Tech 24X6	Macro-Tech 36X12
Cooling	Internal heat sinks with forced-air cooling for rapid, uniform heat dissipation	Internal heat sinks with forced-air cooling for rapid, uniform heat dissipation
Dimensions	EIA Standard 19-inch rack mount (EIA RS-310-B)	EIA Standard 19-inch rack mount (EIA RS-310-B)
Width	3.5 inch (8.9 cm)	3.5 inch (8.9 cm)
Height	16 inch (40.6 cm)	16 inch (40.6 cm)
Depth (behind mounting surface)		
Weight		
Net	45 lb 4 oz (20.5 kg)	50 lb (22.7 kg)
Shipping	54 lb 11 oz (24.8 kg)	59 lb (26.8 kg)
Center of gravity is 6 inches (15.2 cm) behind the front mounting surface		

7 Specifications

Figure 7.1
Typical Frequency Response

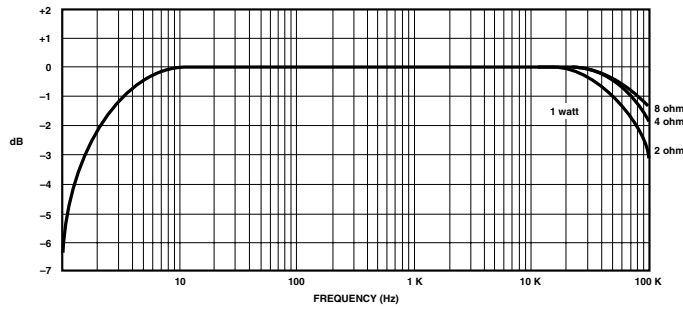

Figure 7.4
Typical Phase Response

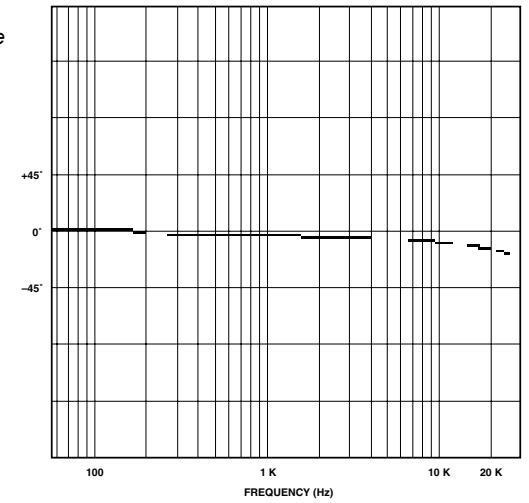

Figure 7.2
Typical Damping Factor

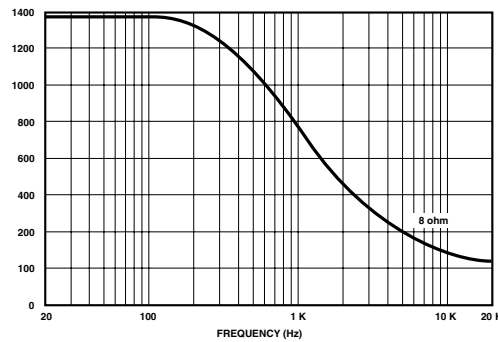

Figure 7.3
Typical Output Impedance

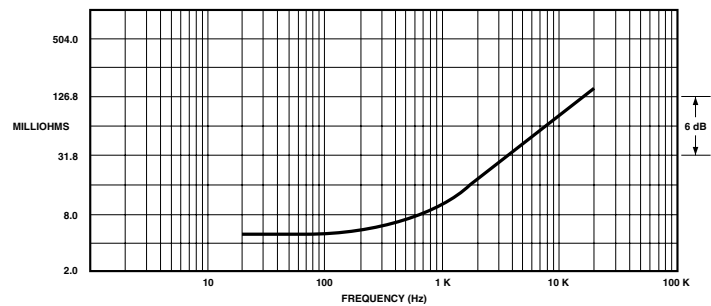
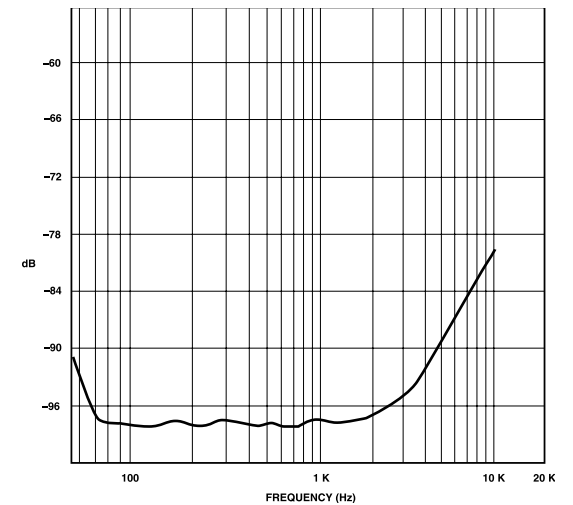

Figure 7.5
Typical Crosstalk



8 AC Power Draw and Thermal Dissipation

This section provides detailed information about the amount of power and current drawn from the Macro-Tech 24X6 and 36X12 amplifiers and the amount of heat produced under various conditions. The calculations presented here are intended to provide a realistic and reliable depiction of the amplifiers. The following assumptions or approximations were made:

- The amplifier's available channels are loaded, and full power is being delivered.
- The amplifier efficiency at standard 1 kHz power is estimated to be 65%.
- Quiescent power draw is 90 watts (an almost negligible amount for full-power calculations).
- Quiescent thermal dissipation equals 105 btu/hr at 90 watts.
- The estimated duty cycles take into account the typical crest factor for each type of source material.
- Duty cycle of pink noise is 50%.
- Duty cycle of highly compressed rock 'n' roll midrange is 40%.
- Duty cycle of rock 'n' roll is 30%.
- Duty cycle of background music is 20%.
- Duty cycle of continuous speech is 10%.
- Duty cycle of infrequent, short duration paging is 1%.

Here are the equations used to calculate the data presented in Figures 8.1 and 8.2:

$$\text{AC Mains Power Draw (watts)} = \frac{\text{Total output power with all channels driven (watts)} \times \text{Duty Cycle}}{\text{Amplifier Efficiency}} + \text{Quiescent and Fan Power Draw (watts)}$$

The following equation converts power draw in watts to current draw in amperes:

$$\text{Current Draw (amperes)} = \frac{\text{AC Mains Power Draw (watts)}}{\text{AC Mains Voltage} \times \text{Power Factor}}$$

The value used for Power Factor is 0.65. The Power Factor variable is needed to compensate for the difference in phase between the AC mains voltage and current.

The following equation is used to calculate thermal dissipation:

$$\text{Thermal Dissipation (btu/hr)} = \left(\frac{\text{Total output power with all channels driven (watts)} \times \text{Duty Cycle} \times \text{Amplifier Inefficiency}}{\text{Amplifier Efficiency}} + \text{Quiescent and Fan Power Draw (watts)} \right) \times 3.415$$

The value used for amplifier inefficiency is 0.35 (1.00-0.65). The factor 3.415 converts watts to btu/hr. Thermal dissipation in btu is divided by the constant 3.968 to get kcal.

If you plan to measure output power under real-world conditions, the following equation may also be helpful:

$$\text{Thermal Dissipation (btu/hr)} = \left(\frac{\text{Total measured output power from all channels (watts)} \times \text{Amplifier Inefficiency}}{\text{Amplifier Efficiency}} + \text{Quiescent and Fan Power Draw (watts)} \right) \times 3.415$$

8 AC Power Draw and Thermal Dissipation

Macro-Tech 24x6

Duty Cycle	L O A D														
	8 Ohm					4 Ohm					2 Ohm				
	AC Mains Power Draw (Watts)	Current Draw (Amps)		Thermal Dissipation		AC Mains Power Draw (Watts)	Current Draw (Amps)		Thermal Dissipation		AC Mains Power Draw (Watts)	Current Draw (Amps)		Thermal Dissipation	
		100-120 V	230 V	btu/hr	kcal/hr		100-120 V	230 V	btu/hr	kcal/hr		100-120 V	230 V	btu/hr	kcal/hr
50%	663	6.7	3.5	992	250	955	9.6	5.0	1342	338	1205	12.1	6.3	1641	414
40%	548	5.5	2.9	855	215	782	7.9	4.1	1135	286	982	9.7	5.1	1374	346
30%	434	4.4	2.3	718	181	609	6.1	3.2	928	234	759	7.6	4.0	1107	279
20%	319	3.2	1.7	581	146	436	4.4	2.3	721	182	536	5.4	2.8	841	212
10%	205	2.1	1.1	444	112	263	2.6	1.4	514	130	313	3.1	1.6	574	145

Figure 8.1 Macro-Tech 24X6 Power Draw, Current Draw and Thermal Dissipation at Various Duty Cycles

Macro-Tech 36x12

Duty Cycle	L O A D														
	8 Ohm					4 Ohm					2 Ohm				
	AC Mains Power Draw (Watts)	Current Draw (Amps)		Thermal Dissipation		AC Mains Power Draw (Watts)	Current Draw (Amps)		Thermal Dissipation		AC Mains Power Draw (Watts)	Current Draw (Amps)		Thermal Dissipation	
		100-120 V	230 V	btu/hr	kcal/hr		100-120 V	230 V	btu/hr	kcal/hr		100-120 V	230 V	btu/hr	kcal/hr
50%	1190	12.0	6.2	1622	409	1663	16.7	8.7	2188	551	1994	20.0	10.4	2583	651
40%	970	9.7	5.1	1359	342	1348	13.5	7.1	1812	457	1613	16.2	8.5	2128	536
30%	750	7.5	3.9	1096	276	1034	10.4	5.4	1436	362	1232	12.4	6.5	1673	422
20%	530	5.3	2.8	833	210	719	7.2	3.4	1059	267	852	8.6	4.5	1218	307
10%	310	3.1	1.6	570	144	405	4.1	2.1	683	172	471	4.7	2.5	762	192

Figure 8.2 Macro-Tech 36X12 Power Draw, Current Draw and Thermal Dissipation at Various Duty Cycles

9 Service

Crown amplifiers are quality units that rarely require servicing. Before returning your unit for servicing, please contact Crown Technical Support to verify the need for servicing.

This unit has very sophisticated circuitry which should only be serviced by a fully trained technician. This is one reason why each unit bears the following label:



CAUTION: To prevent electric shock, do not remove covers. No user serviceable parts inside. Refer servicing to a qualified technician.

9.1 Worldwide Service

Service may be obtained from an authorized service center. (Contact your local Crown/Amcron representative or our office for a list of authorized service centers.) To obtain service, simply present the bill of sale as proof of purchase along with the defective unit to an authorized service center. They will handle the necessary paperwork and repair.

Remember to transport your unit in the original factory pack.

9.2 US and Canada Service

Service may be obtained in one of two ways: from an authorized service center or from the factory. You may choose either. It is important that you have your copy of the bill of sale as your proof of purchase.

9.2.1 Service at a US or Canada Service Center

This method usually saves the most time and effort. Simply present your bill of sale along with the defective unit to an authorized service center to obtain service. They will handle the necessary paperwork and repair. Remember to transport the unit in the original factory pack. A list of authorized service centers in your area can be obtained from the Crown website at www.crownaudio.com, or by calling Crown Customer Service.

9.2.2 Factory Service

To obtain factory service, fill out the service information page found in the back of this manual and send it along with your proof of purchase and the defective unit to the Crown factory.

For warranty service, we will pay for ground shipping both ways in the United States. Contact Crown Customer Service to obtain prepaid shipping labels prior to sending the unit. Or, if you prefer, you may prepay the cost of shipping, and Crown will reimburse you. Send copies of the shipping receipts to Crown to receive reimbursement.

Your repaired unit will be returned via UPS ground. Please contact us if other arrangements are required.

9.2.3 Factory Service Shipping Instructions:

1. Before sending a Crown product to the factory for service, first call the Crown Service Department for a return authorization (RA) number.
2. Be sure to fill out the service information form that follows and enclose it with your shipment, either inside the box or in a packing slip envelope securely attached to the outside of the shipping carton. Do not send the service information form separately. If you are sending the unit from a Shipping Center, we recommend taping the form to the product. We also recommend recording the serial number and model before shipping for your reference.
3. To ensure the safe transportation of your unit to the factory, ship it in an original factory packing container. If you don't have the original carton, you may obtain a product service foam-in-place shipping pack from the Crown Factory Service Department at the number listed below. For non-warranty service, you may also provide your own shipping pack, however we still recommend using a Crown Supplied Shipping

Container. Minimum recommended requirements for materials are as follows: 275 P.S.I. burst test Double-Wall carton that allows for 2-inch solid Styrofoam on all six sides of unit or 3 inches of plastic bubble wrap on all six sides of unit; securely seal the package with an adequate carton sealing tape. Do not use light boxes or "peanuts." Damage caused by poor packing cannot be covered under warranty.

4. Do not ship the unit in any kind of cabinet (wood or metal). Ignoring this warning may result in extensive damage to the unit and the cabinet. Accessories are not needed—do not send the product documentation, cables and other hardware.

If you have any questions, please contact Crown Factory Service.

Crown Factory Service

1718 W. Mishawaka Rd.,
Elkhart, Indiana 46517 U.S.A.

Telephone: 574-294-8200
800-342-6939 (North America,
Puerto Rico, and Virgin Islands only)

Facsimile:
574-294-8301 (Technical Support)
574-294-8124 (Factory Service)

Internet:
<http://www.crownaudio.com>

10 Warranty



SUMMARY OF WARRANTY

Crown International, 1718 West Mishawaka Road, Elkhart, Indiana 46517-4095 U.S.A. warrants to you, the ORIGINAL PURCHASER and ANY SUBSEQUENT OWNER of each NEW Crown product, for a period of three (3) years from the date of purchase by the original purchaser (the "warranty period") that the new Crown product is free of defects in materials and workmanship. We further warrant the new Crown product regardless of the reason for failure, except as excluded in this Warranty.

ITEMS EXCLUDED FROM THIS CROWN WARRANTY

This Crown Warranty is in effect only for failure of a new Crown product which occurred within the Warranty Period. It does not cover any product which has been damaged because of any intentional misuse, accident, negligence, or loss which is covered under any of your insurance contracts. This Crown Warranty also does not extend to the new Crown product if the serial number has been defaced, altered, or removed.

WHAT THE WARRANTOR WILL DO

We will remedy any defect, regardless of the reason for failure (except as excluded), by repair, replacement, or refund. We may not elect refund unless you agree, or unless we are unable to provide replacement, and repair is not practical or cannot be timely made. If a refund is elected, then you must make the defective or malfunctioning product available to us free and clear of all liens or other encumbrances. The refund will be equal to the actual purchase price, not including inter-

UNITED STATES & CANADA

est, insurance, closing costs, and other finance charges less a reasonable depreciation on the product from the date of original purchase. Warranty work can only be performed at our authorized service centers or at the factory. Warranty work for some products can only be performed at our factory. We will remedy the defect and ship the product from the service center or our factory within a reasonable time after receipt of the defective product at our authorized service center or our factory. All expenses in remedying the defect, including surface shipping costs in the United States, will be borne by us. (You must bear the expense of shipping the product between any foreign country and the port of entry in the United States including the return shipment, and all taxes, duties, and other customs fees for such foreign shipments.)

HOW TO OBTAIN WARRANTY SERVICE

You must notify us of your need for warranty service within the warranty period. All components must be shipped in a factory pack, which, if needed, may be obtained from us free of charge. Corrective action will be taken within a reasonable time of the date of receipt of the defective product by us or our authorized service center. If the repairs made by us or our authorized service center are not satisfactory, notify us or our authorized service center immediately.

DISCLAIMER OF CONSEQUENTIAL AND INCIDENTAL DAMAGES

YOU ARE NOT ENTITLED TO RECOVER FROM US ANY INCIDENTAL DAMAGES RESULTING

FROM ANY DEFECT IN THE NEW CROWN PRODUCT. THIS INCLUDES ANY DAMAGE TO ANOTHER PRODUCT OR PRODUCTS RESULTING FROM SUCH A DEFECT. SOME STATES DO NOT ALLOW THE EXCLUSION OR LIMITATIONS OF INCIDENTAL OR CONSEQUENTIAL DAMAGES, SO THE ABOVE LIMITATION OR EXCLUSION MAY NOT APPLY TO YOU.

WARRANTY ALTERATIONS

No person has the authority to enlarge, amend, or modify this Crown Warranty. This Crown Warranty is not extended by the length of time which you are deprived of the use of the new Crown product. Repairs and replacement parts provided under the terms of this Crown Warranty shall carry only the unexpired portion of this Crown Warranty.

DESIGN CHANGES

We reserve the right to change the design of any product from time to time without notice and with no obligation to make corresponding changes in products previously manufactured.

LEGAL REMEDIES OF PURCHASER

THIS CROWN WARRANTY GIVES YOU SPECIFIC LEGAL RIGHTS, YOU MAY ALSO HAVE OTHER RIGHTS WHICH VARY FROM STATE TO STATE. No action to enforce this Crown Warranty shall be commenced after expiration of the warranty period.

THIS STATEMENT OF WARRANTY SUPERSEDES ANY OTHERS CONTAINED IN THIS MANUAL FOR CROWN PRODUCTS. 12/01

10 Warranty



WORLDWIDE EXCEPT USA & CANADA

SUMMARY OF WARRANTY

Crown International, 1718 West Mishawaka Road, Elkhart, Indiana 46517-4095 U.S.A. warrants to you, the ORIGINAL PURCHASER and ANY SUBSEQUENT OWNER of each NEW Crown1 product, for a period of three (3) years from the date of purchase by the original purchaser (the "warranty period") that the new Crown product is free of defects in materials and workmanship, and we further warrant the new Crown product regardless of the reason for failure, except as excluded in this Warranty.

¹ Note: If your unit bears the name "Amcron," please substitute it for the name "Crown" in this warranty.

ITEMS EXCLUDED FROM THIS CROWN-WARRANTY

This Crown Warranty is in effect only for failure of a new Crown product which occurred within the Warranty Period. It does not cover any product which has been damaged because of any intentional misuse, accident, negligence, or loss which is covered under any of your insurance contracts. This Crown Warranty also does not extend to the new Crown product if the serial number has been defaced, altered, or removed.

WHAT THE WARRANTOR WILL DO

We will remedy any defect, regardless of the reason for failure (except as excluded), by repair,

replacement, or refund. We may not elect refund unless you agree, or unless we are unable to provide replacement, and repair is not practical or cannot be timely made. If a refund is elected, then you must make the defective or malfunctioning product available to us free and clear of all liens or other encumbrances. The refund will be equal to the actual purchase price, not including interest, insurance, closing costs, and other finance charges less a reasonable depreciation on the product from the date of original purchase. Warranty work can only be performed at our authorized service centers. We will remedy the defect and ship the product from the service center within a reasonable time after receipt of the defective product at our authorized service center.

HOW TO OBTAIN WARRANTY SERVICE

You must notify your local Crown importer of your need for warranty service within the warranty period. All components must be shipped in the original box. Corrective action will be taken within a reasonable time of the date of receipt of the defective product by our authorized service center. If the repairs made by our authorized service center are not satisfactory, notify our authorized service center immediately.

DISCLAIMER OF CONSEQUENTIAL AND INCIDENTAL DAMAGES

YOU ARE NOT ENTITLED TO RECOVER FROM US ANY INCIDENTAL DAMAGES RESULTING FROM ANY DEFECT IN THE NEW CROWN PRODUCT. THIS INCLUDES ANY DAMAGE TO ANOTHER PRODUCT OR PRODUCTS RESULTING FROM SUCH A DEFECT.

WARRANTY ALTERATIONS

No person has the authority to enlarge, amend, or modify this Crown Warranty. This Crown Warranty is not extended by the length of time which you are deprived of the use of the new Crown product. Repairs and replacement parts provided under the terms of this Crown Warranty shall carry only the unexpired portion of this Crown Warranty.

DESIGN CHANGES

We reserve the right to change the design of any product from time to time without notice and with no obligation to make corresponding changes in products previously manufactured.

LEGAL REMEDIES OF PURCHASER

No action to enforce this Crown Warranty shall be commenced after expiration of the warranty period.

THIS STATEMENT OF WARRANTY SUPERSEDES ANY OTHERS CONTAINED IN THIS MANUAL FOR CROWN PRODUCTS. 7/01



Crown Factory Service Information

Shipping Address: Crown Factory Service, 1718 W. Mishawaka Rd., Elkhart, IN 46517

Phone: 1-800-342-6939 or 1-574-294-8200 Fax: 1-574-294-8124

Owner's Name : _____

Shipping Address: _____

Phone Number: _____ Fax Number: _____ Email _____

Model: _____ Serial Number: _____

Purchase Date : _____

NATURE OF PROBLEM

(Be sure to describe the conditions that existed when the problem occurred and what attempts were made to correct it.)

Other equipment in system: _____

If warranty has expired, payment will be: Cash/Check Visa Master Card C.O.D. Purchase Order for Crown Dealer

Card Number: _____ Exp. Date: _____

Signature: _____

ENCLOSE THIS PORTION WITH THE UNIT. DO NOT MAIL SEPARATELY.

This page intentionally left blank.

This page intentionally left blank.



H A Harman International Company

Free Manuals Download Website

<http://myh66.com>

<http://usermanuals.us>

<http://www.somanuals.com>

<http://www.4manuals.cc>

<http://www.manual-lib.com>

<http://www.404manual.com>

<http://www.luxmanual.com>

<http://aubethermostatmanual.com>

Golf course search by state

<http://golfingnear.com>

Email search by domain

<http://emailbydomain.com>

Auto manuals search

<http://auto.somanuals.com>

TV manuals search

<http://tv.somanuals.com>