



S200 SERIES

# Operator Manual

*This operator manual has information for all models of series SR plus some options and accessories. Some of the illustrations and information may not apply to your truck.*



The most important component is you.



New Bremen, Ohio 45869 USA

© 2005

PF14590-WEB Rev. 6/06

Printed in U.S.A.



Download from [www.somaterials.com](http://www.somaterials.com). All Manuals Search And Download.



## **WARNING**

### **It's the law, you must be trained and certified to operate this truck.** (OSHA § 1910.178, Rev. 1999)

You or others around you can be seriously injured or even killed if you don't use this truck correctly.

Read and obey all warnings and instructions in this Manual\* and on the truck.

Head, arms, hands, legs or feet outside the operator area can be pinned or crushed whenever the truck is moving. Stay within the operator area and stop the truck completely before getting off.

However, tipovers and falls from docks can cause serious injury or even death. Immediately exit and move away from the truck in these emergencies.

You can be trapped or crushed by driving the operator area under racks or other objects. Look where you are going.

Inspect your truck before starting work, make sure it is in good working order.

\* Additional copies of this Operator Manual and all Truck Labels can be obtained from Crown Equipment Corporation, New Bremen, Ohio 45869 U.S.A.

All rights reserved under International and Pan American copyright conventions  
Copyright 2006 Crown Equipment Corp.

# You Must be Trained



### **IT'S THE LAW, YOU MUST BE TRAINED AND CERTIFIED**

Federal law states that only properly trained operators are permitted to operate a powered industrial truck and that your employer must train you and certify that you are qualified to operate this powered industrial truck. (OSHA §1910.178, Rev. 1999)

**Do not operate this truck** in your work place until you have been trained and certified by your employer.

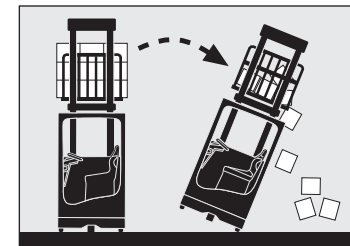

**You could be killed or seriously injured** if you are not adequately trained for lift truck operation!

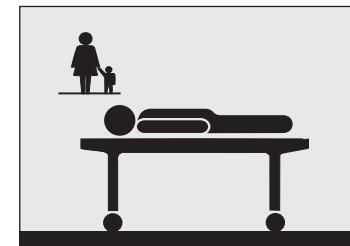

## ! Know the Hazards

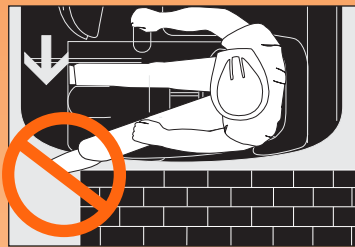

### DRIVE CAREFULLY

- Keep your hands on the controls and feet on the pedals. Keep your entire body in the operator area.
- Never stick a foot or any part of your body outside the operator area, no matter how slow the truck is moving. You cannot stop 4400 kg (9700 pounds) with any part of your body. A foot or hand caught between the truck and a fixed object will be crushed or even cut off.
- Stay away from the edge of docks and ramps. Make sure dockboards are secure. Check that trailer wheels are chocked. You could be seriously injured or even killed in a fall from a dock or dockboard.
- Keep your truck under control at all times. Drive at a speed that allows you to stop safely. Be even more careful on slippery or uneven surfaces. Do not drive over objects on the floor.

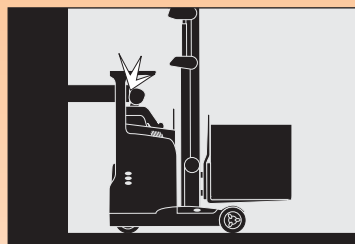
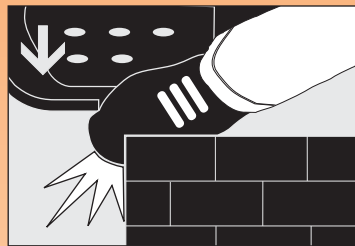

### LOOK WHERE YOU'RE DRIVING

- Always be alert to the area around you and watch where you are driving. You could be pinned or crushed by objects intruding or poking into the operator area.

## ! Know the Hazards



### AVOID FALLS AND TIPOVERS

Falls from docks and tipovers are very serious accidents; you can be crushed or even killed. Immediately exit and move away from the truck in these emergencies.

**Note:** End-control rider trucks, such as this SR, are not like center-control rider trucks, where it is recommended that the operator stay with the truck. The best way to prevent injury is to know where you are at all times and follow the rules of safe truck operation.

- Be extremely careful when working around docks, dockboards and trailers.
- Travel with the load or forks close to the ground and tilted back. Watch for overhead obstructions. Perform all truck movements smoothly and at a speed that will give you time to react in an emergency.
- An unloaded truck can tip over also. Be just as careful using an unloaded truck as you are using a loaded one.

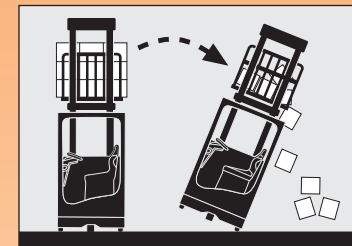

### USE YOUR TRUCK SAFELY

- Keep your hands and feet away from all moving parts such as masts, chains, forks or wheels. Make sure the load backrest is in place.
- Never stand on or under the forks, or allow anyone else to stand on or under them. The only way to lift people is with an approved platform. Never allow passengers on the truck. There is no safe place for them.
- Before you leave your truck:
  - Come to a complete stop and lower forks to the floor.
  - Shut the truck off with the key or power disconnect.

Warning	1
You Must be Trained	2
Protect Yourself	3
Contents	5
What's in it for You?	6
Your Rider-Reach Truck	7
Lift Truck Parts	9
Capacity & Load Center	11
Capacity Plate	13
Display Panel	15
Adjusting the Steering & Seat	17
Power On & Off	19
Switch Panel	20
Braking & Horn	21
Traveling & Plugging	23
Steering & Travel	24
Fork Functions	25
Daily Safety Check	29
Be a Safe Driver	31
Battery Maintenance	35
Warning Labels	38

## WHAT'S IN IT FOR YOU?

The better you understand your truck and how to use it, the better and safer operator you can be. Here are some guides to using this manual.

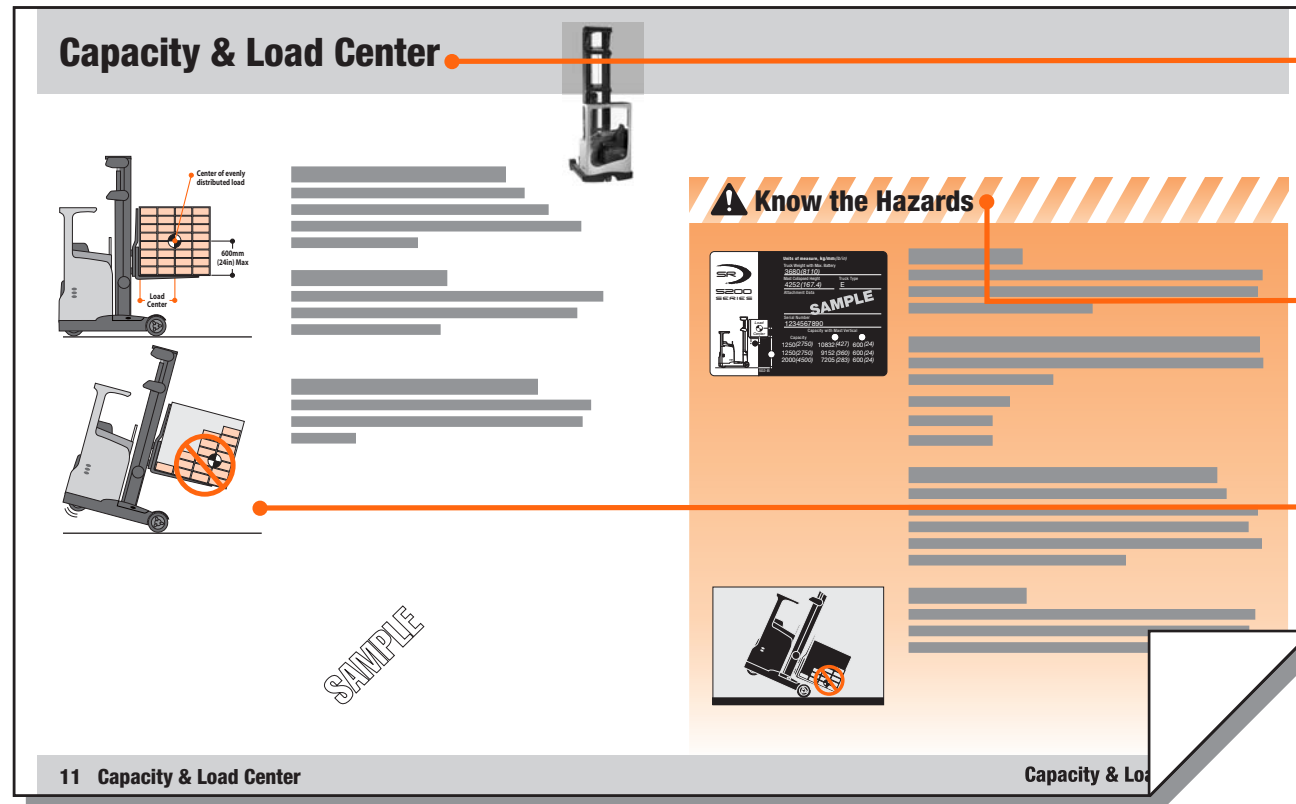

## QUICK LOCATORS

In addition to the "Contents" page you can use page headings to find topics. Some pages also have a picture of the truck in the corner showing features or functions covered on that page.

## "KNOW THE HAZARDS"

Watch for and read these special blocks. You will find information about possible safety hazards and how to avoid them.

## HOW-TO-DRAWINGS

On many pages you will find pictures as well as text to help you understand how to use your truck safely and productively.

# Your Rider-Reach Truck

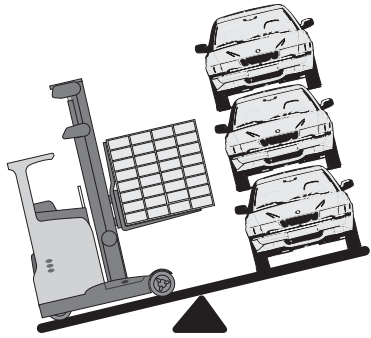

## RIDER-REACH TRUCKS

Your rider-reach truck is designed to lift, move and stack loads.

## YOUR LIFT TRUCK IS NOT AN AUTOMOBILE

With a load it may weigh more than 3 automobiles.

- You don't steer the same.
- You don't sit the same.

## FORK FUNCTIONS, STANDARD AND OPTIONAL

Raising and Lowering the forks, Tilt (fork tips up or down), Reach (extend or retract the mast), Sideshift (right or left), and Rack Height Select are standard on the SR model. Your company may select other options as needed in your work area, and should train you how to use them.

## HOW TO DRIVE YOUR TRUCK

Your truck is equipped with a multi-adjustable seat. You drive your truck by sitting sideways and leaning back into the seat. This, along with your hands on the controls and feet on the pedals or floorboard, gives you stability. The controls are located so you can vary your body position for best comfort and visibility.

## GIVE YOUR BODY A BREAK

Take advantage of stop time. Flex your arms and legs. Staying alert will help you be a better and safer driver.

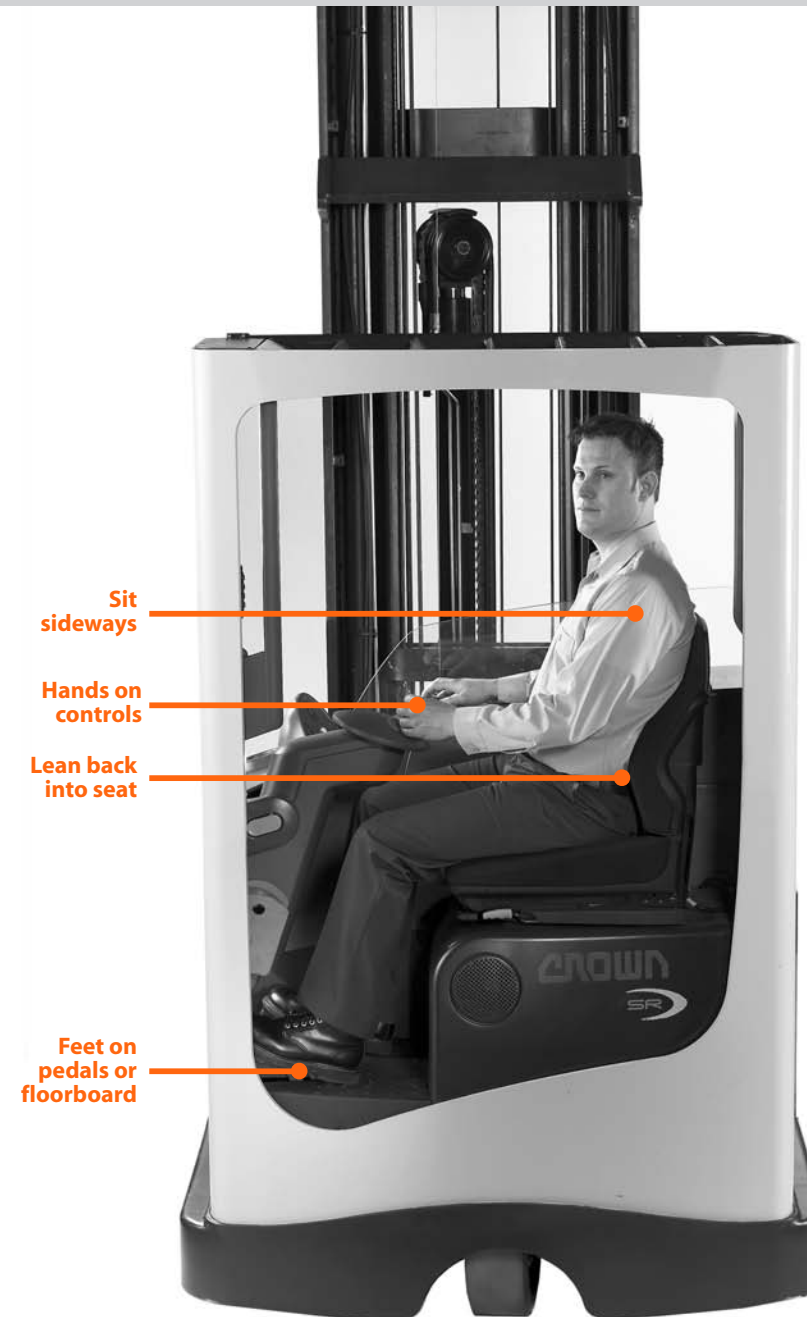

## BUILT TO STANDARDS

This truck was designed and built to current industry and government standards and guidelines. For more information see the following:

- American National Standards Institute (ASME) B56.1
- Occupational Safety and Health Act (OSHA) §1910.178, Rev. 1999
- Underwriters Laboratory (UL) 583
- National Fire Prevention Association (NFPA) 505

# Lift Truck Parts

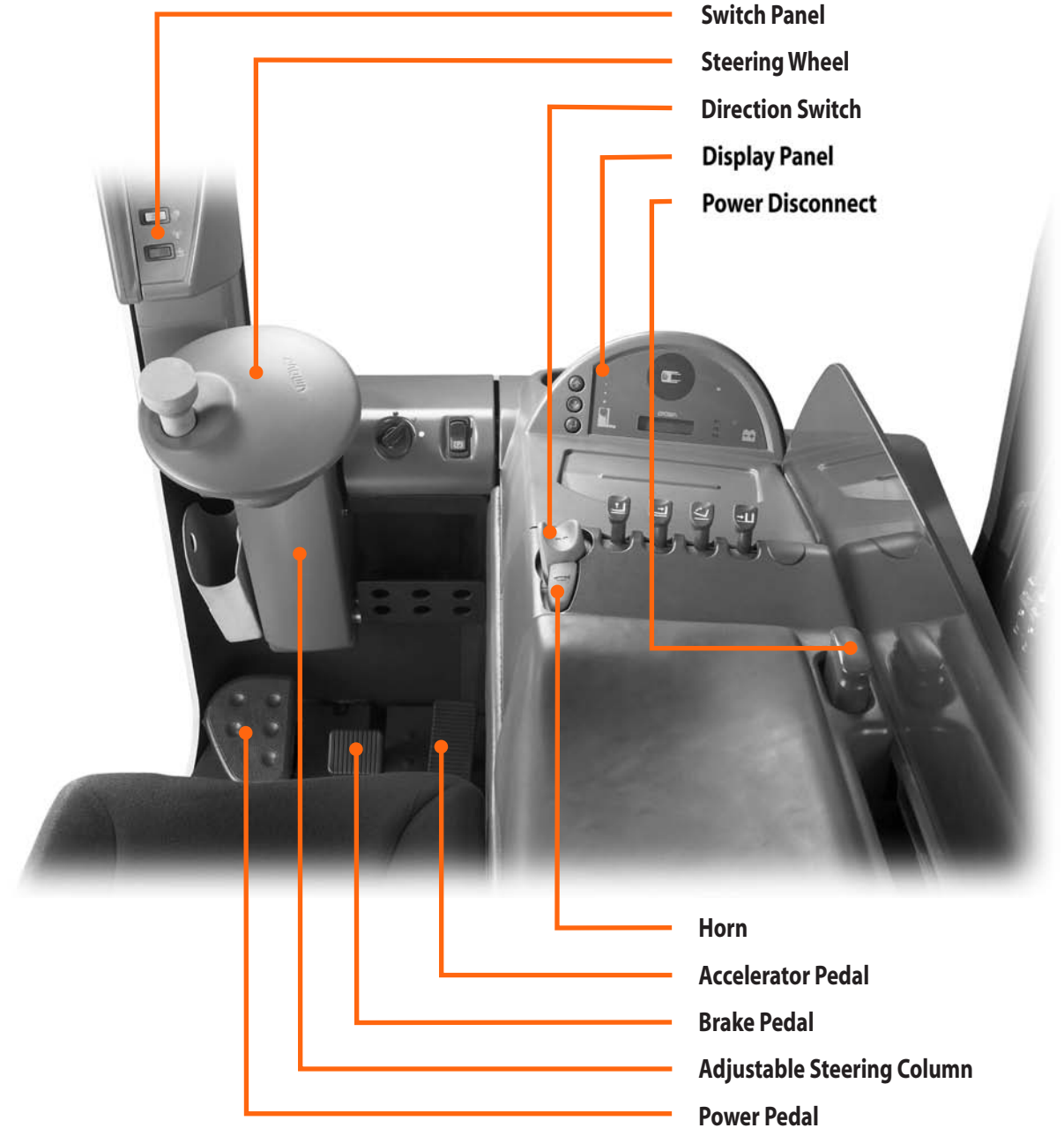
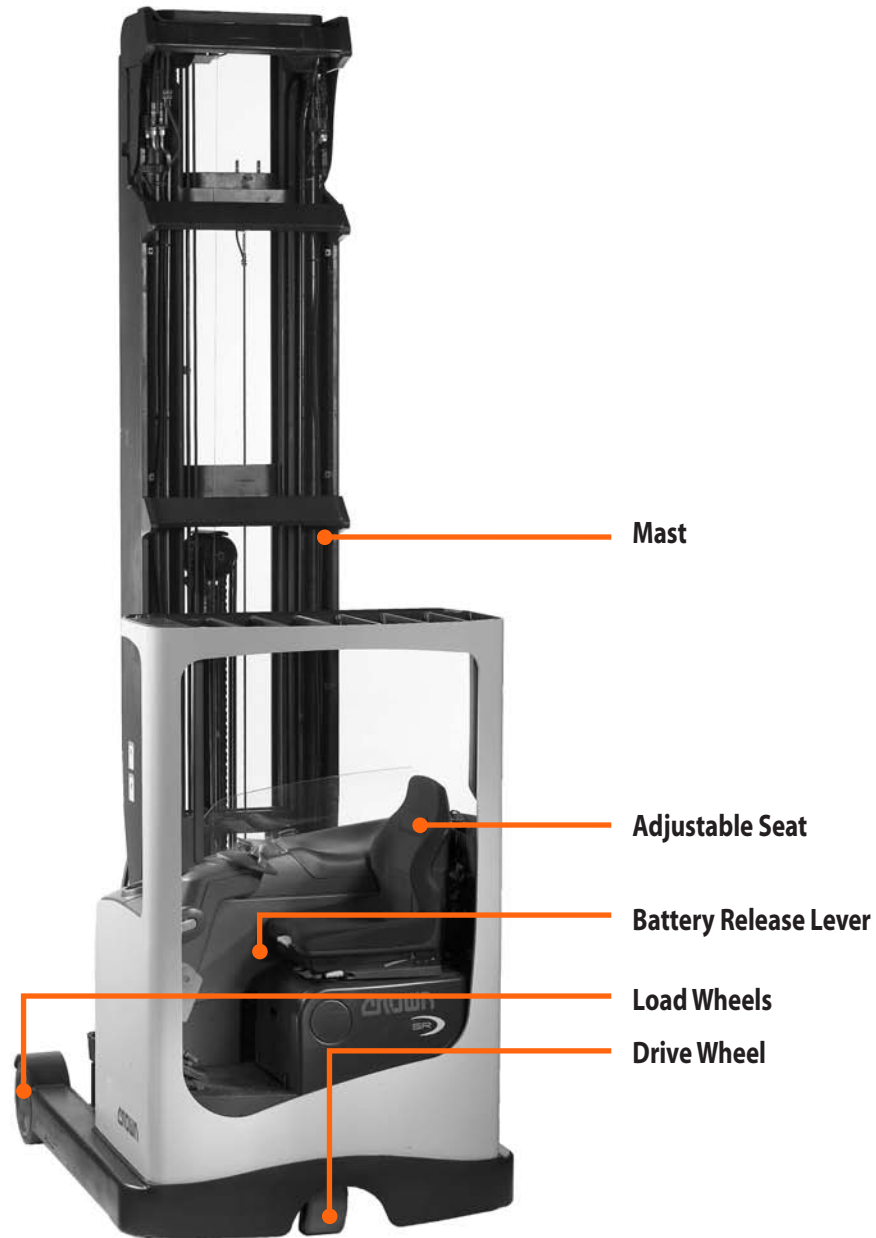

# Capacity & Load Center

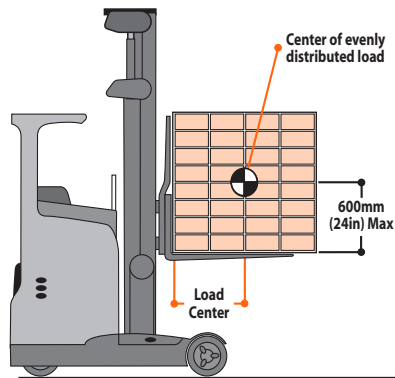

## WHAT IS YOUR TRUCK CAPACITY?

Capacity is the load (including pallet or container) that can be lifted to a given height at a given load center. See the capacity plate on your truck. Make certain you use the correct units of measure.

## WHAT IS LOAD CENTER?

Load center is the distance from the load backrest or vertical face of the forks to the center of an evenly distributed load.

## LOADS MUST BE EVENLY DISTRIBUTED

Your truck could tip over, in any direction, if a load is shifted to the front or side of a pallet or container.

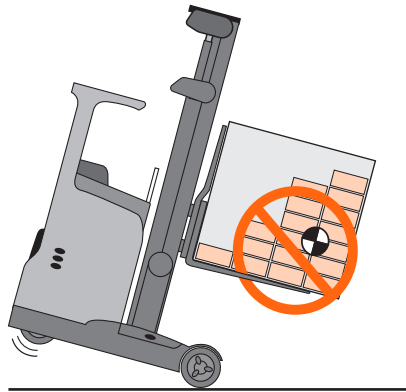

## Know the Hazards

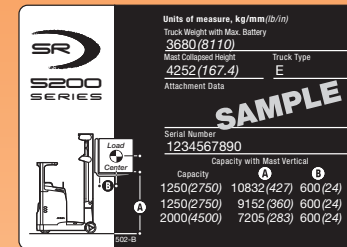

### KNOW YOUR LOAD

Do not exceed the capacity shown on your truck's capacity plate. Be careful when handling long, high or wide loads. Do not handle unstable loads.

### EXCEEDING TRUCK CAPACITY CAN CAUSE AN ACCIDENT

Know the capacity of your truck as shown on your capacity plate. Make certain you use the correct units of measure. Pay attention to:

- Weight of load
- Load center
- Lift height

### CENTER THE LOAD

Your truck could tip over if a load is shifted to the front or side of a pallet or container. Make sure your load is evenly distributed, stable and centered over the forks.

### HYDRAULIC OPERATIONS CAN AFFECT STABILITY

Be careful when using reach, tilt, sideshift or other operations. Remember that anytime the forks move, the load moves also. This can affect stability. Perform all hydraulic operations smoothly. (This also applies to any attachments your truck may have.)



# Capacity Plate

## CAPACITY PLATE INFORMATION

The capacity plate is on the corner support, close to the steering wheel. It contains:

- Serial number
- Capacity information (load, load center and lift height)
- Truck type (a fire safety rating)
- Truck weight with max. battery (does not include load)
- Attachment information (if any)
- Mast collapsed height

## READING YOUR CAPACITY PLATE

Capacity may be reduced as lift height **A** increases. *For example: On the sample plate, 1210kg (2670 lb) can be lifted to 9155mm (360 in). But above 9155 (360), to 11435 (450), capacity is reduced from 1210 (2670) to 600 (1325).*

Capacity is reduced as load center **B** increases. If you must handle loads with longer load centers, an additional capacity plate will show the reduced capacities.

## CAUTION

You may not increase capacity if load center is less than shown on your capacity plate.

**Note:** ANSI B56.1 requires that all data be shown first in Metric units and then USA units.

## OTHER LIFT HEIGHTS & LOAD CENTERS

Contact Crown for capacities at lift heights or load centers not given on your capacity plate.

### SAMPLE CAPACITY PLATE

The information shown on this sample plate does not apply to your truck.

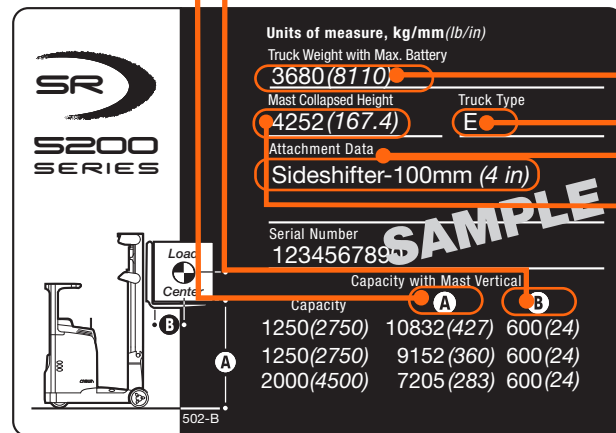

## ! Know the Hazards

### TRUCK WEIGHT

Dockboards, elevators and some floors have limited capacity. Check your capacity plate for the weight of your truck. Make certain to use the correct units of measure. Remember to add the weight of the load you have on the forks.

### TRUCK TYPE

Some truck types are not permitted in areas where there are fire hazards. Watch for marked areas. *For example: You must not drive a type E or ES truck into an area restricted to EE or EX trucks.*

### ATTACHMENT DATA

If an attachment on your truck does not match the information given here on your capacity plate, don't operate your truck. Your capacity plate may be wrong. Report the problem to your supervisor.

### MAST COLLAPSED HEIGHT

Some work areas may have overhead obstructions. Mast Collapsed Height is the minimum height your truck can clear, providing the backrest and load are lowered below the top of the mast.



# Display Panel

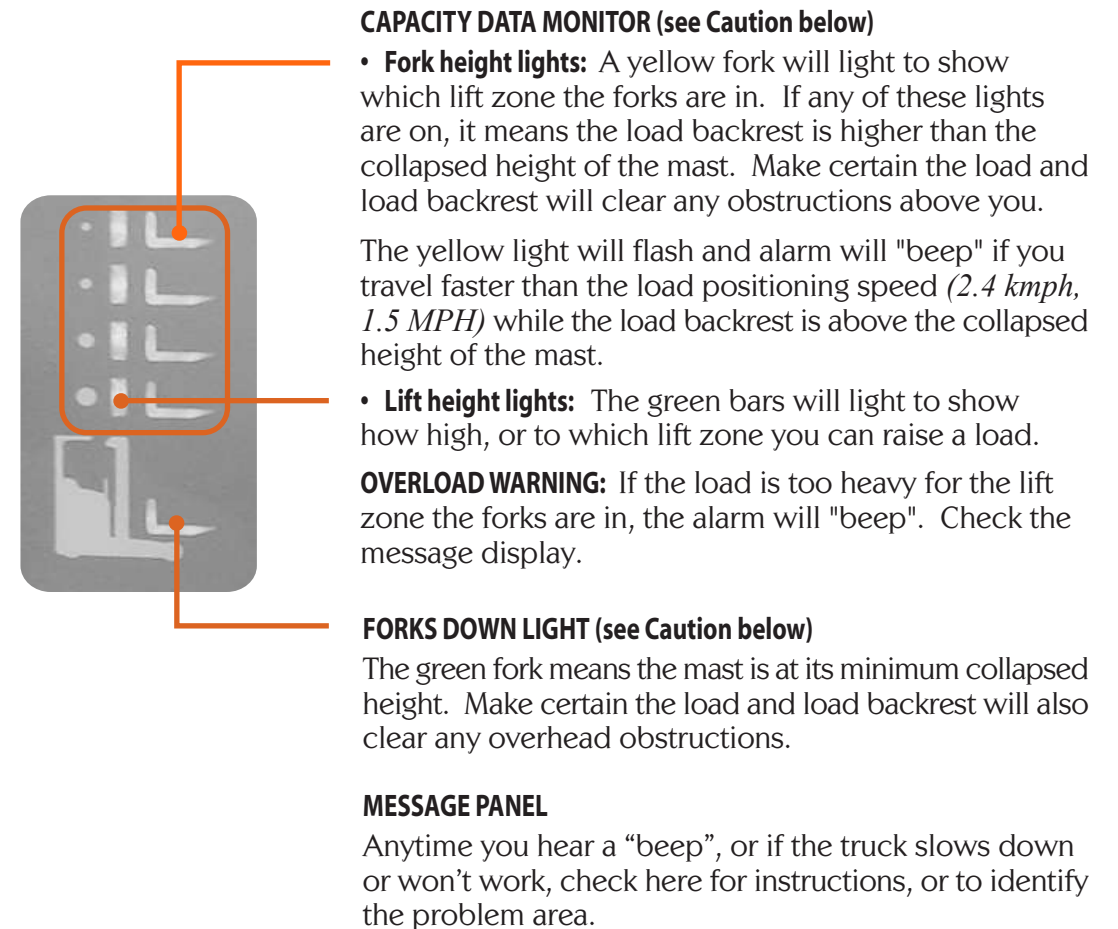
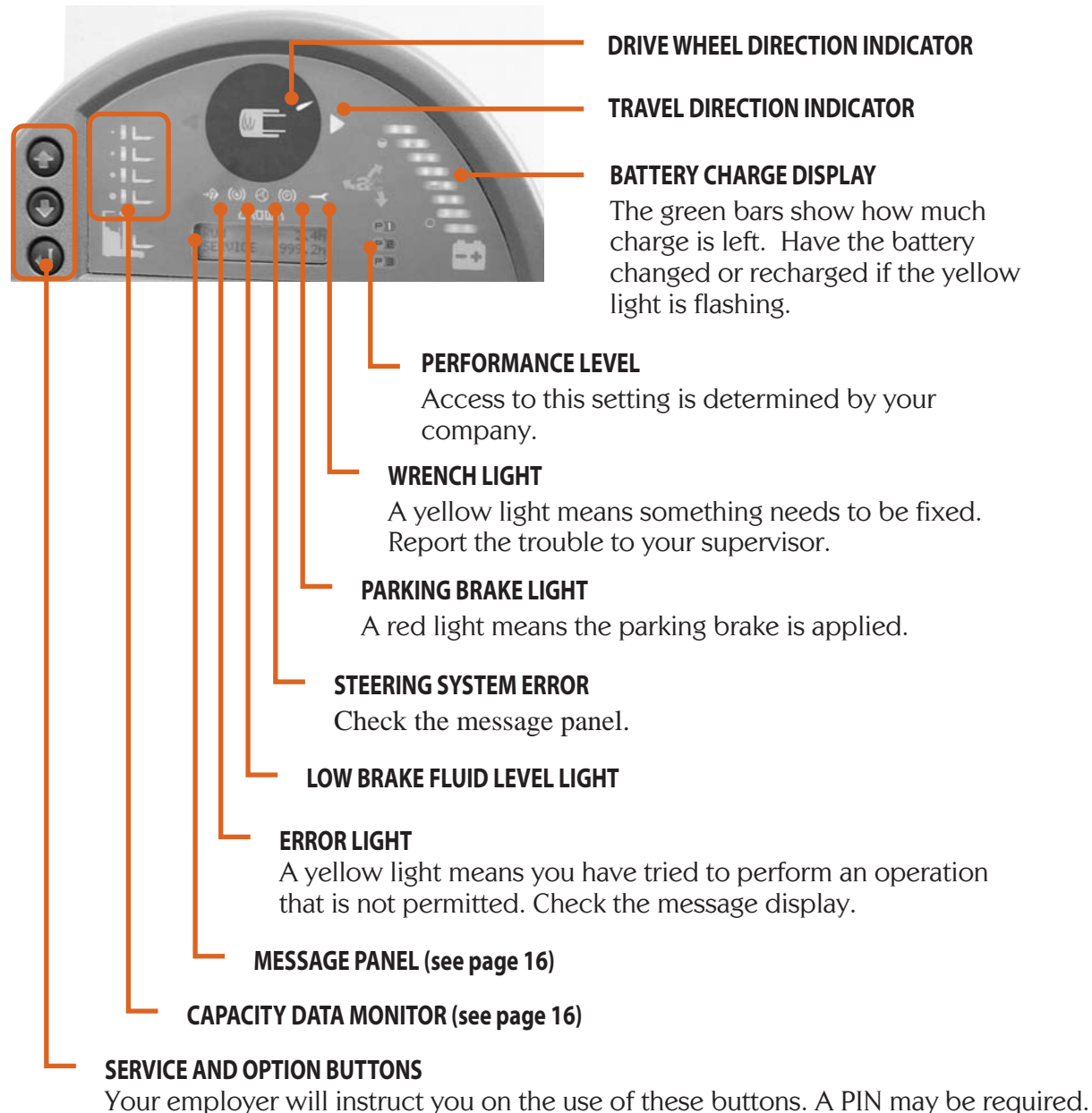

**Caution:** All information displayed by the fork position lights and/or the Capacity Data Monitor is for reference only. You must always be alert to load center, load distribution, load height and load weight. You must also be aware when the load or load backrest extends above the top of the mast, and how much overhead clearance is needed.

# Adjusting the Steering & Seat



## BEFORE YOU DRIVE

Adjust the steering wheel and operator seat to their most comfortable positions.

## ADJUSTABLE STEERING WHEEL & SEAT

Your SR is equipped with an adjustable steering wheel and a multi-adjustable seat.

Before using your truck, adjust the steering wheel and seat to their most comfortable operating positions.

**Caution:** Do not make any adjustments while the truck is moving.

## ADJUSTING THE STEERING WHEEL

Push the button on the left of the steering column, and move the steering wheel to the most comfortable operating position.

Before driving the truck, make certain the steering column is latched and won't move.



## SEAT ADJUSTMENTS

You can adjust your seat 3 ways for comfort:

- Forward & Back
- Backrest Angle
- Operator Weight

## ADJUSTING THE SEAT FORWARD & BACK

Lift the lever on the left side of the seat, and slide the seat forward or back to the most comfortable operating position.

Before driving the truck, make certain the seat is latched and won't move.



## BACKREST ANGLE

Lift the lever at the front of the seat, and move the bottom of the backrest forward or back to the most comfortable operating position.

Before driving the truck, make certain the backrest is latched and won't move.



## OPERATOR WEIGHT

You can adjust the seat suspension for operator weight between 50 kg (110 lb), and 130 kg (287 lb).

- Don't sit on the seat while making this adjustment.
- Pull the lever away from the seat as far as it will go, then release. This resets the lever to 50 kg.
- Pull the lever again until you can read the desired weight setting on the lever.



# Power On & Off



## KEY SWITCH

- To start the truck you must be seated, with both feet on the floorboard (not on any of the pedals), and all controls in neutral.
- Turn the key clockwise to ON (green dot). Check that all display lights are working.
- When leaving the truck, turn the key counterclockwise to OFF (red dot) to shut the truck off.

## USER CODE (PIN number)

A user code (Personal Identification Number) may be required. Your company will issue it to you and instruct you on its use.



## POWER DISCONNECT

Push the power disconnect button down to cut power to the truck.

Use the power disconnect to shut the truck down any time it isn't working right. Don't use the truck if it's not working right. Report the problem to your supervisor.

Pull the power disconnect button up to reconnect the battery.



## POWER PEDAL

Push the power pedal with your left foot. If you are properly seated and the key is turned ON, the steering pump will start running and you can operate the truck.

If you remove your foot from the power pedal while driving, power is cut to all truck operations except for braking and steering.

# Switch Panel

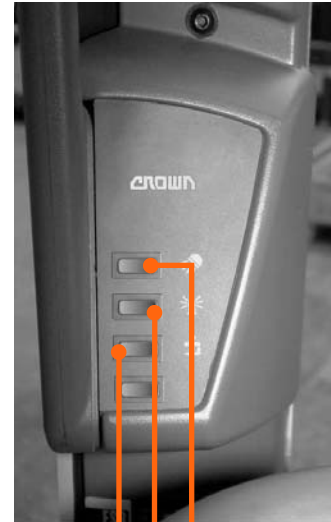

WORK LIGHT SWITCH (optional)

FLASHING LIGHT SWITCH (optional)

RAISE CUTOUT OVERRIDE SWITCH (optional)

Your truck may be equipped with automatic cutout of raise at selected lift heights.

To raise past the cutout height, push the optional Raise Cutout Override switch while, at the same time, pulling the raise/lower lever toward you (see page 25).

**Caution:** Make certain the forks, load and load backrest will clear all overhead obstructions.

# Braking & Horn



## FOOT BRAKE

Step down on the brake pedal to apply the brake. The harder you step down, the harder the braking will be.



## PARKING BRAKE ON

Push the bottom of the parking brake switch to apply the parking brake.

The red brake icon on the display will light whenever the parking brake is applied.

Always apply the parking brake when you leave the truck.

## PARKING BRAKE OFF

Push the top of the parking brake switch to release the parking brake.



## HORN

Press the button on the travel-direction switch to sound the horn. Use it to warn pedestrians and other drivers.

Use your horn when you come to an intersection or a crosswalk.

## ! Know the Hazards

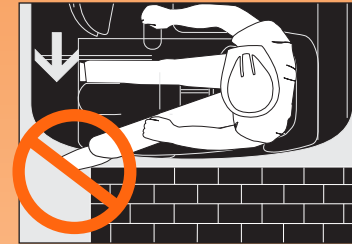

## WATCH YOUR FEET

Keep your feet inside the truck and on the pedals at all times. This truck weighs about 4400 kg (9700 pounds) even without a load on the forks. You cannot stop or even slow down that much weight with your foot or any part of your body, no matter how slow the truck is moving.

A foot or hand caught between the truck and a wall, post or any fixed object will be crushed or even cut off.

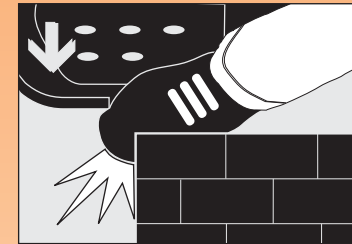

## MAKE SURE YOUR BRAKES WORK

Test the brakes on your truck at the start of each shift. Know the distance it takes to stop before you start working.

If at any time the stopping distance is too long for you to stop safely, don't drive the truck. Report any problem to your supervisor.

## PLUGGING VS. BRAKING

Of the two, the foot brake is designed to stop the truck in the shortest distance. Use the foot brake in an emergency, on ramps or in busy areas.

# Traveling & Plugging

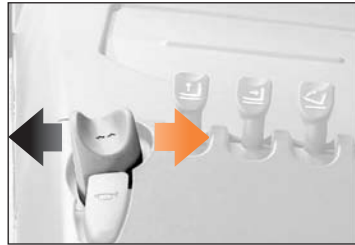

## TRAVEL DIRECTION AND SPEED

Move the direction control toward the mast to travel forks first. Move the control away from the mast to travel power unit first (forks trailing).

Step down on the accelerator to control travel speed. The farther you push it down, the faster the truck will go.

When you sit down in the seat, the direction control must be placed in neutral before you select a travel position.

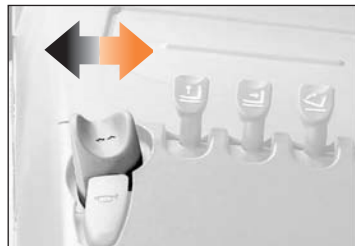

## PLUGGING

Plugging is another way to slow down or stop your truck.

While the truck is moving, in either direction, select the opposite direction of travel. Use the accelerator to control how quickly you slow down. Plugging will not stop your truck as fast as using the foot brake.

Plugging does not hurt your truck.

# Steering & Travel



## STEERING AND DRIVING

Steering is not the same in both directions. Be careful. Drive slowly until you get used to all the controls.

## TRUCKS THAT LOOK ALIKE CAN BE DIFFERENT

This style truck can be built with one of two different types of steering(see below).

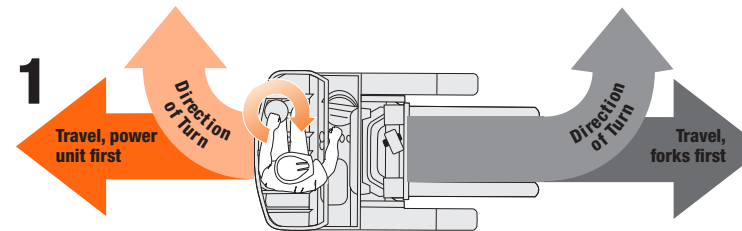

## REAR DIRECTIONAL STEERING (Also called Reverse Steering.)

Shows direction truck will turn when steering handle is turned clockwise.

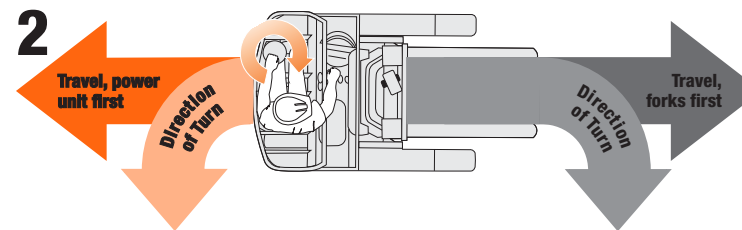

## FRONT DIRECTIONAL STEERING (Also called Forward Steering.)

Shows direction truck will turn when steering handle is turned clockwise.

## ! Know the Hazards

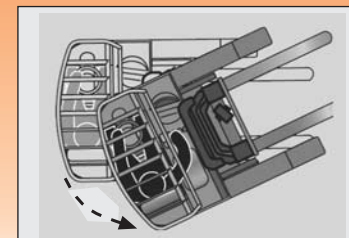

## POWER UNIT SWING

Be careful turning while traveling forks first. The power unit will swing wide in the opposite direction. Make sure you have clearance, and watch out for people in the area.

**Caution:** If you ever drive a different SR Series truck, be careful. The steering may be different.

# Fork Functions



## FORK FUNCTIONS

Standard fork functions include:

Raising and Lowering the forks, Tilt (fork tips up or down), Reach (extend or retract the mast), Sideshift (right or left), and Rack Height Select which allows the truck to be programmed so the forks will stop at selected heights.

Your company may select additional optional fork functions for your truck.



### RAISE/LOWER

Pull the raise/lower lever toward you to raise the forks. Push the lever away from you to lower the forks.

The farther you move the lever away from neutral, in either direction, the faster the forks will move.

### RAISE CUTOUT OPTION

Your truck may be equipped with an automatic cutout to prevent you from raising the forks into restricted areas.

See page 20 for using the optional Raise Cutout Override Switch.

**Caution:** Make certain the forks, load and load backrest will clear all overhead obstructions.

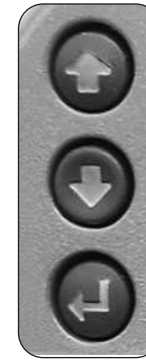

### RACK HEIGHT SELECT OPTION

This option allows a truck to be programmed so the forks will stop at a selected height.

Your employer will instruct you how to use the service and option buttons to access this option. A PIN may be required.

Make certain the path of the forks is clear. Pull the raise/lower lever toward you. The forks will stop and there will be a one second “beep” when they reach the programmed height. Check to make certain the forks are at the correct position before entering the rack or pallet.

## Know the Hazards

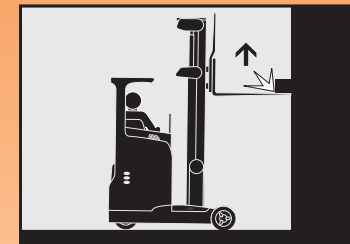

### CHECK THE PATH OF THE FORKS

Be just as careful raising the forks with the rack height select option as when using manual raise. Make certain the path of the forks is clear and free of obstacles.

Check that the forks are at the proper position to enter the pallet, or that the pallet will clear the rack beam.

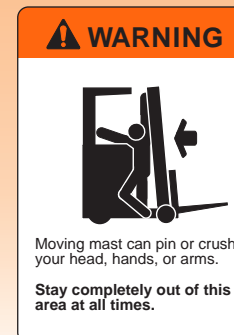

### WATCH OUT FOR THE MOVING MAST

Any part of a body caught between the moving mast and the truck could be pinned or crushed.

Stay completely out of this area at all times. Never allow anyone else to be in this area.

# Fork Functions continued

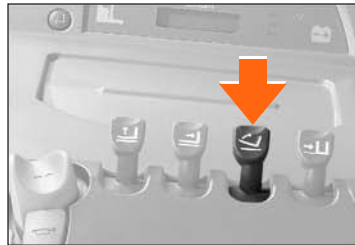

## TILT UP & DOWN



Pull the tilt lever toward you to tilt the fork tips up. Push the lever away from you to tilt the fork tips down.

The farther you move the lever away from neutral, in either direction, the faster the forks will move.

## TILT POSITION ASSIST OPTION

If your truck is equipped with this option, and it is turned on, the forks will stop at the programmed tilt position.

To tilt farther, repeat the tilt lever motion.

## FORK POSITION WILL VARY DEPENDING ON LOAD

The tilt of the forks and raised height of the forks will change depending on how much load is on the forks.

Always check to see that the forks are at the correct tilt position and lift height to enter a pallet, or that the pallet and load will clear the rack beams.

Be just as careful when using programmed functions as when operating the truck manually.

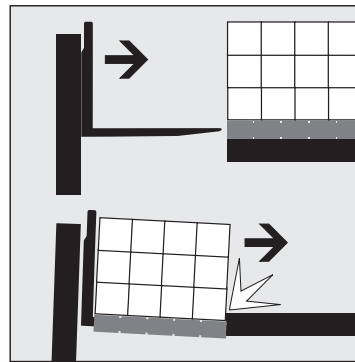

## REACH/RETRACT



Push the reach lever away from you to reach (extend) the mast. Pull the lever toward you to retract the mast.

The farther you move the lever away from neutral, in either direction, the faster the forks will move.



## SIDESHIFT



Pull the sideshift lever toward you to move the forks to the right. Push the lever to move the forks to the left.



## Know the Hazards

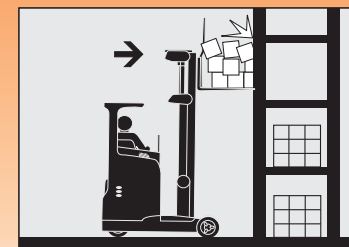

## CHECK FORK AND PALLET POSITION

The fork position will vary depending on whether the forks are loaded or unloaded.

Make certain the forks are at the correct tilt position and lift height to enter a pallet, or that the pallet and load will clear the rack beams.

# Daily Safety Check

## CHECK YOUR TRUCK BEFORE STARTING WORK

You must make sure your truck is safe to use.

### 1. Walk around your truck and check it over.

- Check to make sure the battery is charged, water level is OK and vent caps are in place. Don't use an open flame to check the battery.
- Make certain the battery retainer is properly installed.
- See that all wheels are in good condition.
- Clean the safety glass.
- Check that both forks are secure and not bent, cracked or badly worn.
- Inspect lift chains for damage.
- See that the load backrest is in place and fastened.
- Look under the truck for signs of hydraulic leaks.
- Turn the key to ON (green dot). See that all display lights are working.
- Test the horn.
- Make sure the power disconnect works.

### 2. Test drive your truck in an uncongested area.

- Try all the hydraulic functions.
- Check that the steering is easy and smooth.
- Drive the truck slowly in both directions.
- Drive through the full speed range in both forward and reverse.
- Check braking and plugging distances in forward and reverse. Load size and floor conditions can affect these distances.
- Know the distance it takes to stop before you start working. If the braking distance is too long to stop safely, don't drive the truck.

**If anything doesn't look or feel right, don't drive the truck. Report the problem to your supervisor.**

*You can get checklist forms from your Crown dealer (part no. OF-3772). Used properly, this checklist can alert service people to needed repairs.*



# Be a Safe Driver

*The most  
important  
component  
is you.*



## MAKE SURE YOU ARE READY TO DRIVE

- Do not use this truck unless you are trained and certified.
- Be certain you understand how your truck works and the hazards that go with it. Don't drive the truck if you have any doubts.
- Know the capacity of your truck (Load Weight, Load Center and Lift Height). Make certain to use the correct units of measure.
- Some trucks are not allowed in areas where there are fire hazards. Be certain your truck is the correct fire safety type for the area.
- Make sure your hands and shoes are clean and dry, and your clothing is proper for the job.

## MAKE SURE YOUR TRUCK IS READY

- Inspect your truck before using it (see pages 29 and 30). If it's not working right, or something is broken, report the problem to your supervisor. Don't use the truck.
- In an open area, test the brakes and plugging. Check at a slow travel speed first, then a faster one. Know the distance it takes to stop before you start work.

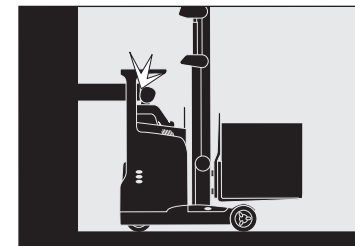
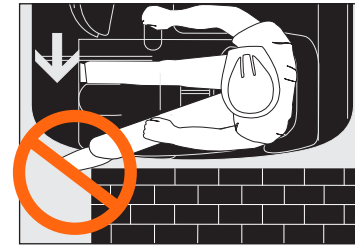

## DRIVE CAUTIOUSLY, BE ALERT

- Never stick a foot or any part of your body outside the operator area, no matter how slow the truck is moving. You cannot stop 4400 kg (9700 pounds) with any part of your body. A foot or hand caught between the truck and a fixed object will be crushed or even cut off.
- Keep your hands on the controls and your feet on the pedals or floorboard.
- Travel in the direction that gives you the best view. Look where you are going and slow down in congested areas.
- Slow down for wet or slippery floors. Don't run over things.
- Travel with the forks close to the ground, retracted and tilted up. Place the load against the load backrest (vertical face of the forks).
- Look where you are going before you change direction of travel.
- See that you have room to drive and turn. Always check for overhead objects. Watch out for power unit swing.
- Slow down when making turns.
- Avoid sudden movement of controls. Learn to use them smoothly at a moderate, even rate.
- Check clearances before raising or lowering the forks or load.
- Be extra careful if you must use your truck in an area where there is a risk of falling objects.

*Continued next page...*

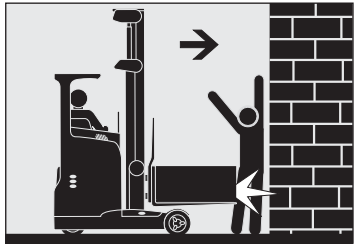

## WATCH OUT FOR OTHER PEOPLE

- Slow down. Yield or stop for pedestrians. Use your horn when you come to a crosswalk or intersection.
- Be careful that you don't pin or crush someone. *For example: Never drive your truck toward anyone standing in front of a fixed object.*
- Watch out for power un it swing.
- Never allow passengers on your truck.
- Keep others away from your truck while you're working. Don't ever allow anyone on or under the load or forks.
- Don't let anyone use your truck unless they are trained and certified.
- Never lift anyone with the forks unless they are using an approved platform. Even then use extreme caution:
  - Use a securely attached and approved safety platform.
  - Make certain lifting mechanism is operating properly.
  - Have load backrest vertical (never tilt when elevated).
  - Make certain truck is in neutral and brake is applied.
  - Lift and lower slowly.
  - Watch for overhead obstructions.
  - Be sure you can see and hear the person being lifted.
- Never transport anyone on the platform from one location to another.

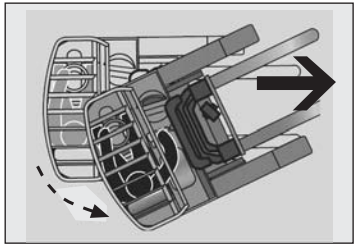

## AVOID FALLS AND TIPOVERS

- Stay away from the edge of docks and ramps.
- Check that bridgeplates and dockboards are secure. Be certain that either the trailer wheels are chocked or the trailer is locked to the dock. Check capacities. Be sure your truck, with load, isn't too heavy for where you are driving.
- Make sure the load you are moving is stable. Spread the forks as far as you can and center the load. Insert the forks as far under the load as you can. Be even more careful with long, high or wide loads. They can be less stable.
- Use minimum fork tilt to pick up or place a load. When lifting or lowering outside a rack, keep the load backrest vertical or tilted back slightly.
- When moving loads on grades or ramps, drive with your forks pointed upgrade. Without a load, drive with forks downgrade. Slow down, and don't turn on grades or ramps.

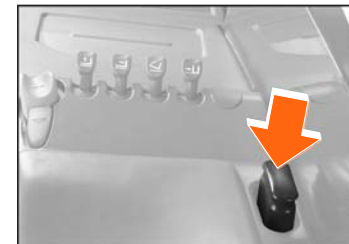
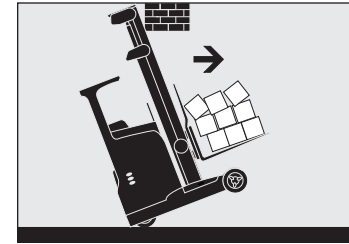

## LEAVING YOUR TRUCK

- Stop your truck completely and before getting off.
- Lower the forks to the floor.
- Apply the parking brake.
- Turn the truck off or push the Power Disconnect button.
- Avoid parking on inclines. But if you must, block the wheels of your truck.

# Battery Maintenance



## ! Know the Hazards

**! DANGER**



**Batteries produce explosive gas.** Do not smoke, use open flame, or create an arc or sparks near this battery. Ventilate well in enclosed areas and when charging.

Batteries contain **Sulfuric Acid** which causes severe burns. Do not get in eyes, on skin, or clothing. In case of contact, flush immediately. Get medical attention if your eyes are affected.

107

### TRUCK BATTERIES CAN BE DANGEROUS

Your truck battery produces fumes that can explode. It also contains acid that could burn or disfigure you.

- Do not try to install, remove, charge or service your truck battery unless you are trained and authorized.
- Never smoke or use an open flame around batteries.
- Your company should provide an area where it is safe to work on batteries. Use that area for all battery work.
- Use protective equipment such as gloves, eye shields, aprons etc.

### BEFORE CHARGING YOUR TRUCK BATTERY

- See that the battery cells are filled to the proper level. Never use an open flame to check the battery.
- Read the battery charger instructions and make certain the charger is the same voltage and amperage as your battery.
- Be sure the charger is turned OFF before connecting the battery to the charger. Otherwise you might create a spark which could cause the battery to explode.

### BATTERY SIZE

Use the correct size and weight battery. Never operate a truck with an underweight or undersized battery installed.

**! WARNING**

**Minimum battery size allowed**  
**xxx mm (xx.xx in.) wide**  
**xxx mm (xx.xx in.) long**

Undersize battery can affect truck handling and stability. You could have an accident.

Use U.L. classified Type EO battery.

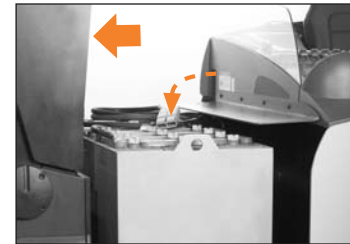
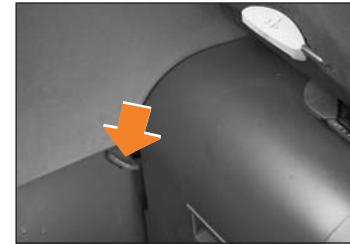

### REMOVING THE BATTERY FOR SERVICE

- Retract the mast all the way, and lower the forks.
- Push down on the battery lever. The battery is now connected to the mast.
- Fully extend the mast. The battery will move with the mast.
- Switch off the truck and remove the key.
- Disconnect the battery from the truck.

### CHARGING YOUR BATTERY

- Connect the battery to the proper charger.
- Follow the directions on the battery and the battery charger.

*Continued next page...*

# Battery Maintenance continued



## CHANGING YOUR BATTERY

- Loosen the battery retainer clamp. Lift and remove the retainer.
- Never let anything metal touch the top of the cells. You could cause a spark or do damage to the battery. Use an insulator (such as plywood) when necessary.
- If you use a roller stand to install or remove a battery, make sure the roller stand is the same height as the rollers in the truck's battery compartment. Also make sure the roller stand is at least as long as your battery.
- Use an approved spreader bar to place a battery on, or remove it from, the truck or a stand. Make sure you adjust the spreader bar hooks to fit the battery.
- When replacing the battery, make certain you use the correct size and weight battery. Never operate a truck that has an underweight or undersized battery installed.
- Replace the battery retainer and tighten the retainer clamp.

## RETURNING YOUR BATTERY

- Connect the battery to the truck.
- Fully retract the mast, moving the battery into the battery compartment. You should hear the battery latch unhook.
- Extend the mast and make certain the battery remains in the battery compartment.

# Warning Labels

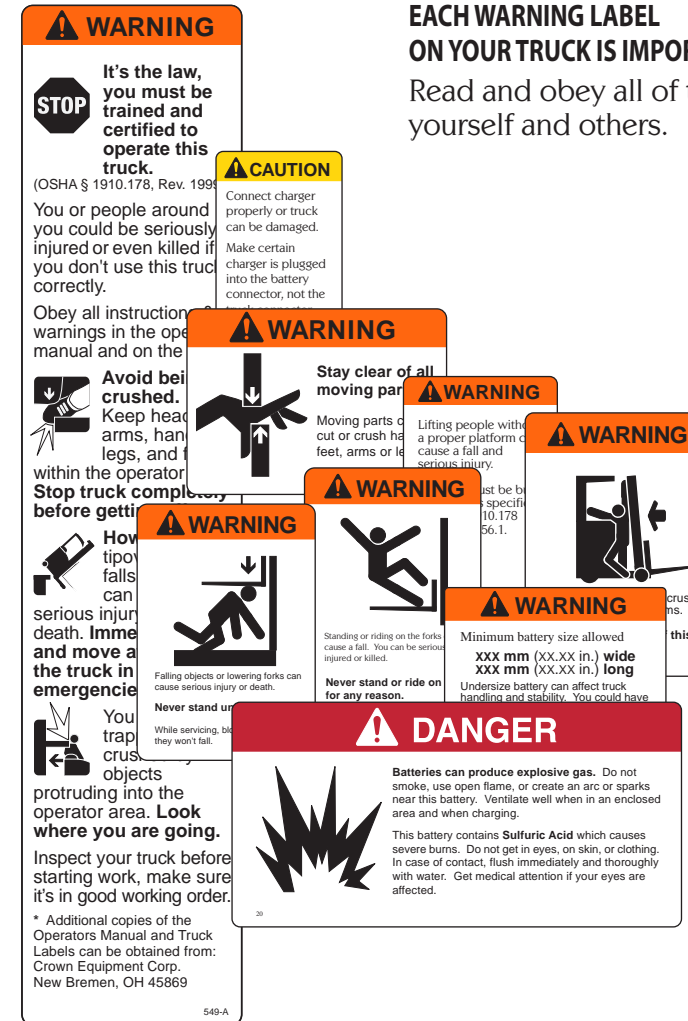

## EACH WARNING LABEL ON YOUR TRUCK IS IMPORTANT

Read and obey all of them to protect yourself and others.

## Free Manuals Download Website

<http://myh66.com>

<http://usermanuals.us>

<http://www.somanuals.com>

<http://www.4manuals.cc>

<http://www.manual-lib.com>

<http://www.404manual.com>

<http://www.luxmanual.com>

<http://aubethermostatmanual.com>

Golf course search by state

<http://golfingnear.com>

Email search by domain

<http://emailbydomain.com>

Auto manuals search

<http://auto.somanuals.com>

TV manuals search

<http://tv.somanuals.com>