

# *Cub Cadet*

## **Owner's Manual**

**8 & 11 H.P.  
Riders**

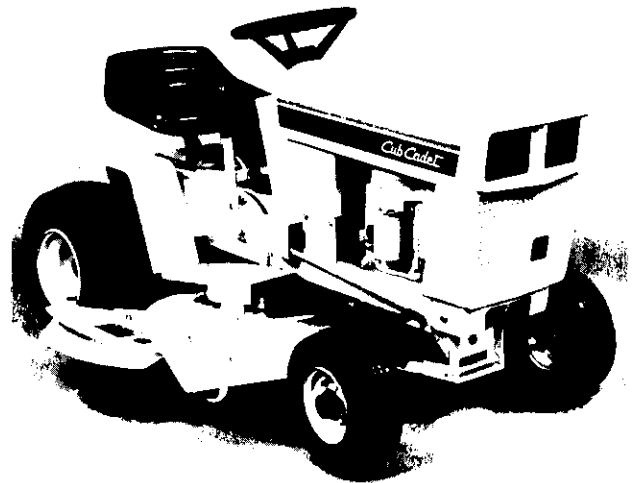

### **Important:**

**Read Safety Rules and  
Instructions Carefully**

Thank you for purchasing an  
American built product.

**Model Numbers  
182, 282,  
382 and 383**

**CUB CADET CORPORATION • P.O. BOX 36930 • CLEVELAND, OHIO 44136**  
PRINTED IN U.S.A.

Download from [www.somanuals.com](http://www.somanuals.com). All Manuals Search And Download.

FORM NO. 772-3223



# Cub Cadet Corporation Limited One Year Warranty For Outdoor Power Products

## **Cub Cadet Corporation's Promise To You**

We promise you, the first user purchaser, that we will replace or repair any part or parts of your new outdoor power product which is defective in material or workmanship without charge for either parts or labor during the first year following delivery to you.

## **What You Must Do**

We recommend that you take the product back to the dealership where you purchased it at your expense; however, you may also take it to the most convenient authorized Cub Cadet dealer. Transportation charges are your responsibility.

## **Replacement Parts Warranty**

Cub Cadet parts which are furnished and installed under this warranty are themselves within the coverage of this warranty for the duration of the original one year warranty period or for ninety days after installation, whichever period shall expire last.

## **What Is Not Covered**

Tires and tubes are not covered by this warranty, but are warranted by their manufacturer. Regular maintenance replacement items such as spark plugs, ignition points, condensers, filters, and lubricants and maintenance adjustments such as fuel system cleaning, engine tune-up, brake and/or clutch inspection or adjustment, when such replacement or adjustments are made as part of normal maintenance service are excluded from coverage. Any non-Cub Cadet product which you may have installed in or upon the product is also excluded.

No person is authorized to give any other warranties or to assume any other liabilities on the Company's behalf unless made or assumed in writing by the Company, and no person is authorized to give any warranties or to assume any liabilities on the seller's behalf unless made or assumed in writing by the seller.

## **Limitations On Our Responsibility**

Please carefully note that this is a two-way agreement. We promise to make free repairs or replacements as stated, but you agree that except for our obligation to make good on this promise we shall not be responsible for any expenses or inconvenience which you might incur or experience with respect to our product, nor shall we be liable for defects, damage, or failures caused by unauthorized alterations, unreasonable use, accident, or abuse, including failure to provide reasonable and necessary maintenance, after our product has been delivered to you. Some states do not allow the exclusion or limitation of incidental or consequential damages, so the above limitation or exclusion may not apply to you. This warranty gives you specific legal rights, and you may also have other rights which vary from state to state.

## **Personal Use**

The foregoing paragraphs constitute Cub Cadet Corporation's entire warranty with respect to any product purchased and used for personal, family, or household purposes as distinguished from commercial usage.

## **Commercial Use**

In the event our product is used for commercial purposes, INCLUDING FARMING OPERATIONS, the following additional limitations upon the application of this warranty will be applicable to such product.

**THIS WARRANTY IS IN LIEU OF ALL OTHER WARRANTIES, EXPRESSED OR IMPLIED. WARRANTIES OF MERCHANTABILITY AND FITNESS FOR PARTICULAR PURPOSE ARE EXCLUDED, AS ARE ALL OTHER REPRESENTATIONS TO THE USER-PURCHASER, AND ALL OTHER OBLIGATIONS OR LIABILITIES, INCLUDING LIABILITY FOR INCIDENTAL AND CONSEQUENTIAL DAMAGES, ON THE PART OF THE COMPANY OR THE SELLER.**

**Cub Cadet Corporation • P.O. Box 36930 • Cleveland, Ohio 44136**

# CONTENTS

To The Owner .....	4	Lubrication Guide .....	13
Serial No. Location .....	4	Maintenance .....	15
Safe Operations .....	5	Off-Season Storage .....	22
Controls .....	6	Trouble Shooting .....	23
Operation .....	9	Specifications .....	24
Adjustments .....	10		



This unit is equipped with an internal combustion engine and should not be used on or near any unimproved forest-covered, brush-covered or grass-covered land unless the engine's exhaust system is equipped with a spark arrester meeting applicable local or state laws (if any). If a spark arrester is used, it should be maintained in effective working order by the operator.

In the State of California the above is required by law (Section 4442 of the California Public Resources Code). Other states may have similar laws. Federal laws apply on federal lands. A spark arrester muffler is available at your nearest engine authorized service center.

# To The Owner

Your new Cub Cadet® Lawn Tractor is designed to meet today's exacting operating requirements. It is built for efficient, economical performance, ease of operation, and with the ability to adjust to various conditions. These features lighten your work and shorten your hours on the job.

You are urged to consult your authorized dealer concerning unusual conditions or special applications. Let the experience of your dealer and the organization associated with him serve you.

Assembled in this manual are operation, lubrication, and maintenance instructions for the Cub Cadet 182, 282, 382 and 383 Lawn Tractors. The material has been prepared in detail to help you better understand the correct care and efficient operation of your tractor. Before you operate the tractor, study this manual carefully. Additional copies may be ordered from your dealer at a nominal price.

When in need of parts, always specify the chassis and engine serial numbers, including any prefix or suffix letters. Write these serial numbers in the spaces provided. See figures 1 and 2.

After the cutting season, thoroughly clean your lawn tractor and inspect it. Preventative maintenance pays dividends. Your dealer has original-equipment parts which assure proper fit and best performance. He is able to recondition your equipment to a like new condition.

The Cub Cadet 182 and 382 Lawn Tractors have a transaxle transmission.

The Cub Cadet 282 and 383 Lawn Tractors have a hydrostatic drive.

## SERIAL NUMBER LOCATION

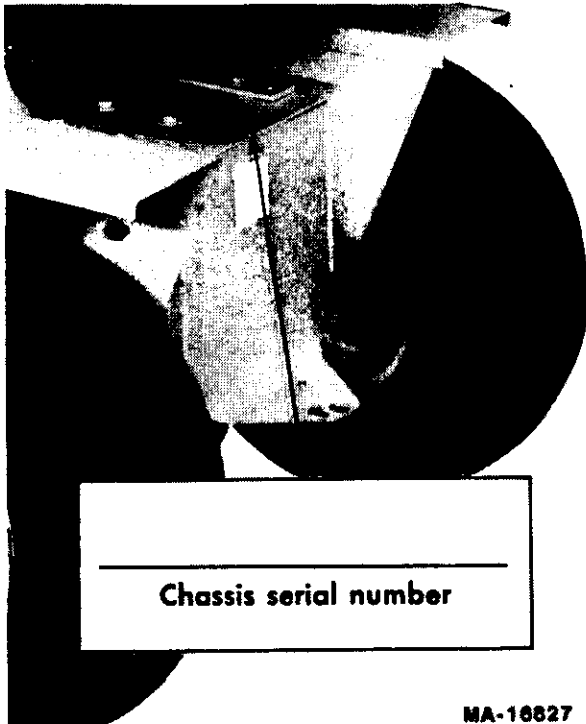

FIGURE 1.

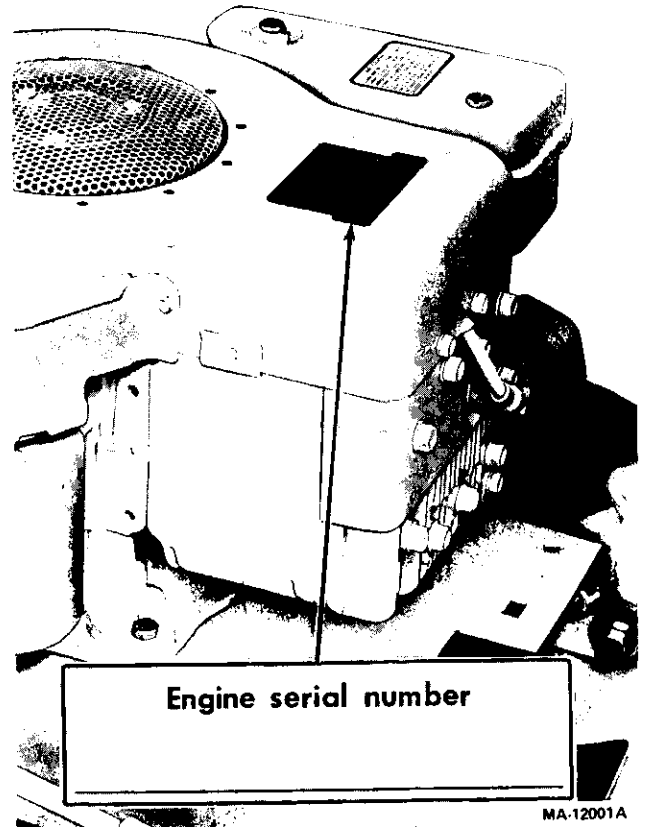

FIGURE 2.

DELIVERY  
DATE \_\_\_\_\_



**WARNING**

To reduce the potential for any injury, comply with the following safety instructions. Failure to comply with the instructions may result in personal injury.

## SAFE OPERATION PRACTICES FOR RIDING VEHICLES

1. Read this owner's manual carefully in its entirety before attempting to assemble or operate this unit. Keep this manual in a safe place for future and regular reference and for ordering replacement parts.
2. This unit is a precision piece of power equipment, not a plaything. Therefore exercise extreme caution at all times.
3. Know the controls and how to stop quickly—**READ THIS OWNER'S MANUAL.**
4. Do not allow children to operate vehicle. Do not allow adults to operate it without proper instruction. Only persons well acquainted with these rules of safe operation should be allowed to use your mower.
5. No one should operate this unit while intoxicated or while taking medication that impairs the senses or reactions.
6. Wear sturdy, rough-soled work shoes and close-fitting slacks and shirts to avoid entanglement in the moving parts. Never operate a unit in bare feet, sandals, or sneakers.
7. To prevent injury, do not carry passengers or give rides. Keep children, pets and bystanders out of the area while mowing. Only the operator should ride on the unit and only ride in the seat.
8. Check overhead clearance carefully before driving under power lines, guy wires, bridges or low hanging tree branches, before entering or leaving buildings, or in any other situation where the operator may be struck or pulled from the unit, which could result in serious injury.
9. To maintain control of the unit and reduce the possibility of upset or collision, operate the tractor smoothly. Avoid erratic operation and excessive speed.
10. Keep the area of operation clear of all persons, particularly small children and pets. Stop engine when they are in the vicinity of your mower. Although the area of operation should be completely cleared of foreign objects, a small object may have been overlooked and could be accidentally thrown by the mower in any direction and cause injury.
11. Clear work area of objects which might be picked up and thrown by the mower in any direction and cause injury.
12. Stop the blade(s) when crossing gravel drives, walks or roads.
13. Disengage all attachment clutches and shift into neutral before attempting to start engine.
14. Disengage power to attachment(s) and stop engine before leaving operating position.
15. Do not put hands or feet near or under rotating parts. Keep clear of the discharge opening at all times as the rotating blade(s) can cause injury.
16. Disengage power to attachment(s) and stop engine before making any repairs or adjustments. Disconnect the spark plug wire and keep the wire away from the plug to prevent accidental starting.
17. Before attempting to unclog the mower or discharge chute, stop the engine. The mower blade(s) may continue to rotate for a few seconds after the engine is shut off. Therefore, be sure the blade(s) have stopped completely. Disconnect the spark plug wire and keep the wire away from the plug to prevent accidental starting.
18. Disengage power to attachment(s) when transporting or not in use.
19. Take all possible precautions when leaving vehicle unattended such as disengaging power-take-off, lowering attachments, shifting into neutral, setting parking brake, stopping engine and removing key.
20. Do not stop or start suddenly when going uphill or downhill. Mow up and down face of steep slopes; never across the face. Use extreme caution if it is necessary to drive the tractor up an incline or back the tractor down an incline because the front of the tractor could lift and rapidly flip over backward which could cause serious injury.
21. Reduce speed on slopes and in sharp turns to prevent tipping or loss of control. Always keep the tractor in gear when going down steep hills to take advantage of engine braking action.
22. Stay alert for holes in terrain and other hidden hazards.
23. Use care when pulling loads or using heavy equipment.
  - A. Use only approved drawbar hitch points.
  - B. Limit loads to those you can safely control.
  - C. Do not turn sharply. Use care when backing.
  - D. Use counterweight(s) or wheel weights when suggested in owner's manual.
24. Watch out for traffic when crossing or near roadways.
25. When using any attachments, never direct discharge of material toward bystanders nor allow anyone near vehicle while in operation.
26. Handle gasoline with care. It is highly flammable.
  - A. Use approved gasoline container.
  - B. Never remove cap or add gasoline to a running or hot engine or fill fuel tank indoors. Wipe up spilled gasoline.
  - C. Open doors if engine is run in garage. Exhaust fumes are dangerous. Do not run engine indoors.

27. Keep the vehicle and attachments in good operating condition, and keep safety devices in place. Use guards as instructed in operator's manual.
28. Keep all nuts, bolts, and screws tight to be sure the equipment is in safe working condition.
29. Never store the equipment with gasoline in the tank inside a building where fumes may reach an open flame or spark. Allow engine to cool before storing in any enclosure.
30. To reduce fire hazard, keep engine free of grass, leaves or excessive grease.
31. The vehicle and attachments should be stopped and inspected for damage after striking a foreign object. The damage should be repaired before restarting and operating the equipment.
32. Do not change the engine governor settings or overspeed the engine.
33. When using the vehicle with mower, proceed as follows:
  - (1) Mow only in daylight or in good artificial light.
  - (2) Never make a cutting height adjustment while engine is running if operator must dismount to do so.
  - (3) Shut the engine off and wait until the blade comes to a complete stop before removing the grass catcher.
  - (4) Check blade mounting bolts for proper tightness at frequent intervals.
34. Check grass catcher bags frequently for wear or deterioration. For safety protection, replace only with new bag meeting original equipment specifications.
35. Look behind to make sure the area is clear before placing the transmission in reverse and continue looking behind while backing up. Disengage blades before shifting into reverse and backing up.
36. This unit should not be driven up a ramp onto a trailer or truck under power, because the unit could tip over, causing serious personal injury. The unit must be pushed manually to load properly.

## CONTROLS

Your Cub Cadet Tractor has been safety engineered. Thoroughly acquaint yourself with all the instruments and controls before attempting to start or operate the tractor.

**NOTE:** LEFT and RIGHT indicate the left and right sides of the tractor when facing forward in the driver's seat. Reference to FRONT indicates the grille end of the tractor; to REAR the drawbar end.

### THROTTLE CONTROL

The throttle control is used to regulate the engine speed and to activate the choke on the engine. To get maximum efficiency from cutting, the throttle should be in the FAST position when operating the mower. Pushing the throttle all the way forward past FAST, will choke the engine. See figures 3 or 4.

### IGNITION SWITCH

Turn the key to the "START" position to start the engine. When the engine is running, let the key return to the "ON" position. To stop the engine, turn the key to the left to the "OFF" position and remove it to prevent accidental starting. See figures 3 or 4. The key cannot be removed when in the "ON" position.

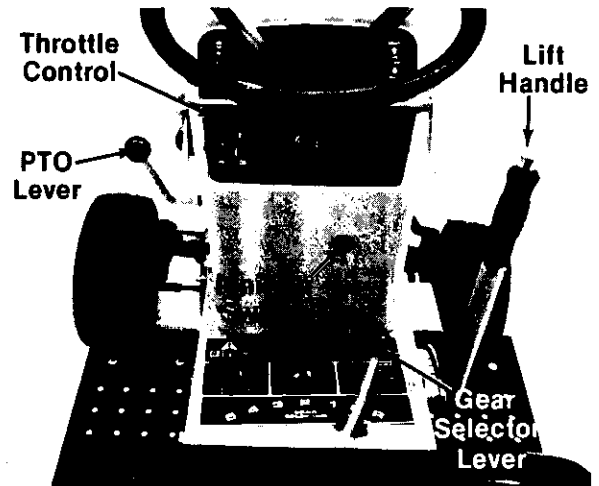

FIGURE 3. Models 182 and 382

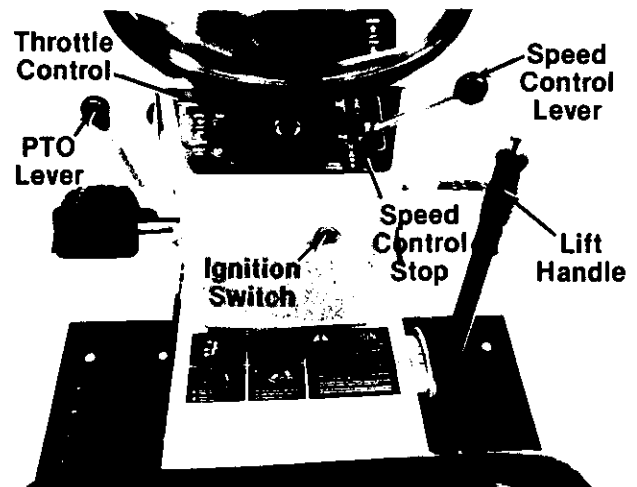

FIGURE 4. Hydrostatic Models 282 and 383

## GEAR SELECTOR LEVER

### Transaxle Models 182 and 382

The gear selector lever is used to select one of five Forward Gears, "NEUTRAL" or "REVERSE." See figure 3.

## SPEED CONTROL LEVER

### Hydrostatic Models 282 and 383

The speed control lever connected to the hydrostatic transmission controls both the speed and direction of the tractor. Infinite speed control is achieved by moving the control lever forward or backward. The farther forward you move the control lever, the faster you will travel. Pulling the control lever into neutral (N) area will stop the tractor. To increase rear wheel torque (pulling power), move the control lever towards neutral (N) position. The lawn tractor responds similar to shifting to a lower gear with a gear type transmission. See figure 4.

## SPEED CONTROL STOP

### Hydrostatic Models 282 and 382

An adjustable speed control stop is provided to allow the operator to return to a predetermined speed. The speed control lever can bypass the speed control stop by pushing the lever outward and sliding it past the stop. See figure 4.

## RELEASE LEVER

### Hydrostatic Models 282 and 383

To push or move the tractor for a short distance, place the speed control lever in the "NEUTRAL" position and hold the release lever in the down position. See figure 5.



### WARNING

Never operate engine with release lever in (down) position. Towing or pushing the tractor for more than a few feet may result in transmission damage.

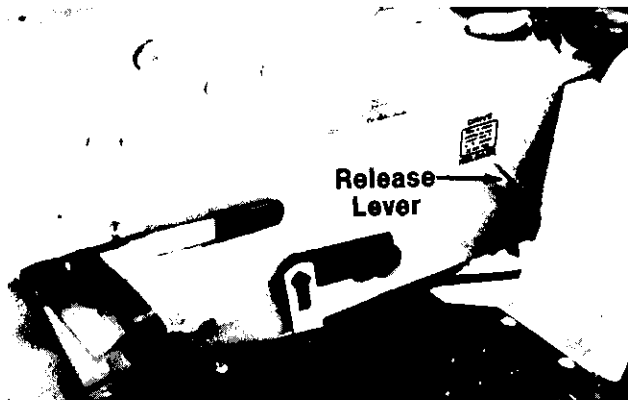

FIGURE 5.

## CLUTCH-BRAKE PEDAL

### Hydrostatic Models 282 and 383

The clutch-brake pedal is located on the left side of the lawn tractor. Depressing the pedal disengages the engine from the hydrostatic transmission and applies the brake. You can release the clutch pedal and resume the same speed without moving the hydrostatic control lever. See figure 6.

### Transaxle Models 182 and 382

The clutch-brake pedal is located on the left side of the lawn tractor. Depressing the clutch-brake pedal part way disengages the clutch. Pressing the pedal all the way down disengages the clutch and engages the disc brake. See figure 8.

**NOTE:** The clutch-brake pedal must be depressed to start the engine.

## BRAKE LOCK LEVER

Always lock the brake when the tractor is parked on a grade. To lock the brake, press down on the pedal; then place the brake lock lever in the engaged position. See figure 6. To disengage the lock, press down on the pedal, lift the brake lock lever up and place it in the disengaged position.

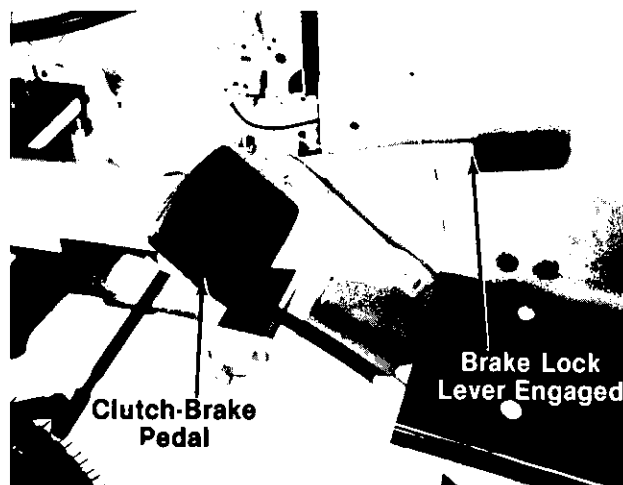

FIGURE 6.



### WARNING

The hydrostatic transmission will not hold the tractor on a hill. In a short period of time (depending on the hill) the oil will drain from the transmission and allow the tractor to roll down hill. To avoid an accident and/or possible injury, lock the brake.

## POWER TAKE-OFF (PTO) LEVER

The PTO lever is located on the left side of the dashboard. To engage the PTO, push the lever forward. To disengage the PTO pull the lever back. See figures 3 or 4.

**NOTE:** The PTO lever must be in the disengaged position when starting the engine and when shifting into reverse.

## LIFT HANDLE

The lift handle is used to lift or lower equipment used with the lawn tractor. The equipment can be set in multiple positions by depressing the button on the handle and releasing it when the desired position is reached. See figure 7.

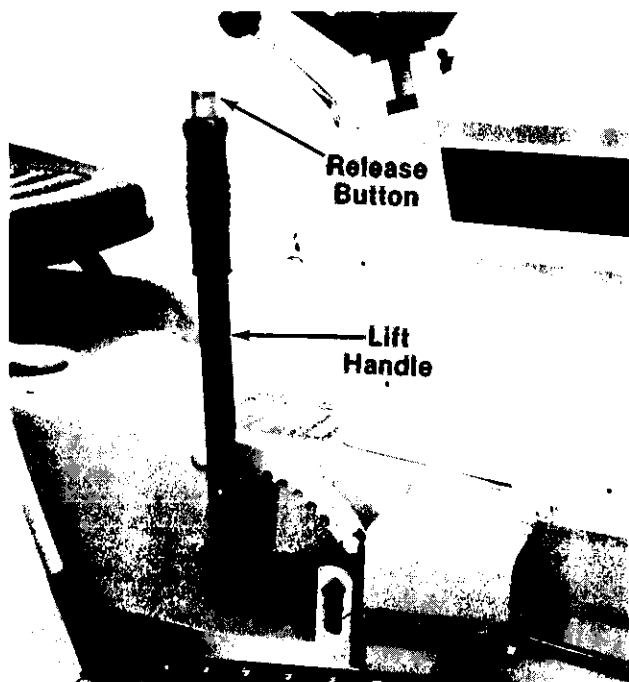

FIGURE 7.

## INTERLOCKS (Not Shown)

Interlock safety switches are located at an activated by the clutch-brake pedal, the PTO lever and the seat.

The safety starting switches activated by the clutch-brake pedal and the PTO lever serve to prevent starting the engine accidentally. The clutch-brake pedal must be depressed and the PTO lever in the "OFF" position before engine will start.

When using PTO operated equipment, the operator must remain in tractor seat at all times. If operator should leave tractor seat without moving the PTO to the "OFF" position, the engine will automatically shut off. In addition, the PTO lever must be in the "OFF" position when shifting tractor into reverse or the engine will shut off automatically.

## GASOLINE TANK

The gasoline tank is located under the hood. See figure 10.

**NOTE:** The tractor hood is arranged to swing up and forward in order to make the engine, fuel tank, air cleaner, etc., readily accessible.

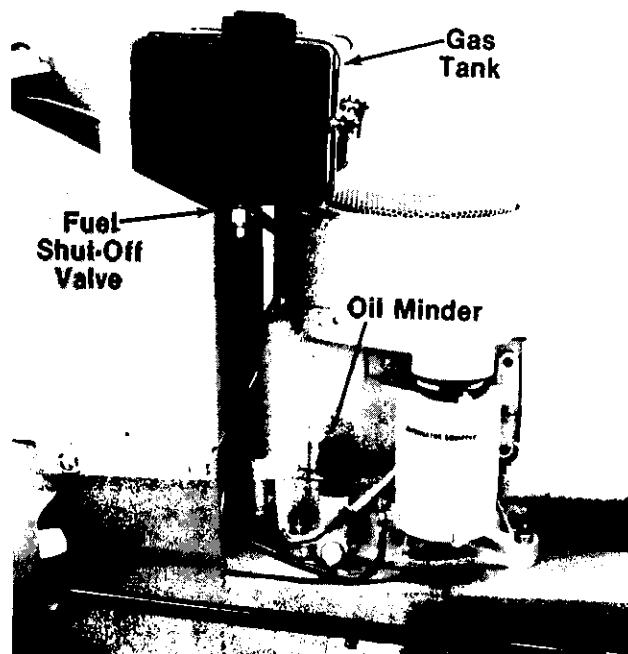

FIGURE 8.

## FUEL SHUT-OFF VALVE

The fuel shut-off valve is located below the gasoline tank. See figure 8.

To turn the fuel on, turn the knob counterclockwise to the stop.

To turn the fuel off, turn the knob clockwise until it is tight.

## OIL MINDER

The oil minder is a gauge and a filler cap. See figure 8. To check the oil level, press down on the rubber plunger and release. If any oil is visible in the clear tube of the gauge, the oil level is "OK."

**NOTE:** The gauge does not have to fill completely.



# OPERATION



## CAUTION

**RECEIVE INSTRUCTION**—Read operator's manual. Learn to operate this machine **SAFELY**. Don't risk **INJURY** or **DEATH**.

1. Before starting engine or operation:  
Be familiar with controls.  
Be in operator's position with transmission in neutral, PTO turned off, and brake depressed.
2. Keep shields in place. Keep away from moving parts.
3. **NO RIDERS!** Keep all people and pets a safe distance away. Look before backing up.
4. Don't point mower discharge at people.
5. Avoid slopes. Tractors can be rolled over.
6. Before leaving operator's position:  
Shut off PTO. Place transmission in neutral. Set parking brake. Shut off engine. Remove ignition key. Wait for all movement to stop before servicing or cleaning.
7. Do not fill gasoline tank when engine is running or while engine is hot. Tighten cap securely.

## BEFORE OPERATING YOUR TRACTOR

1. Before you operate the tractor study this manual carefully. It has been prepared to help you operate and maintain your tractor with utmost efficiency.
2. Familiarize yourself with the operation of all the instruments and controls.
3. Fill the fuel tank with clean, fresh, lead-free, low-lead or regular grade leaded gasoline.



## CAUTION

To avoid fire or injury, tighten fuel cap securely. Never remove the fuel tank cap or fill the fuel tank when the engine is running, or hot, or indoors. Also, do not smoke when working around flammable fuel.

4. Be sure the fuel shut-off valve is open.
5. Check the engine oil level.
6. Clean the air cleaner element if necessary.
7. Check the tire inflation pressures.

8. Adjust the seat for operator's maximum comfort, visibility, and complete control of the tractor.
9. Refer to various sections of the operator's manual for additional information.

## STARTING THE ENGINE

**NOTE:** This unit is equipped with a safety interlock system for your protection. The purpose of the safety interlock system is to prevent the engine from cranking or starting unless the clutch-brake pedal is depressed and the PTO lever is in the "OFF" position. In addition, the PTO lever must be in the "OFF" position when the unit is put into reverse or the engine will shut off. Operator must remain in the seat when the PTO lever is on or the engine will shut off.



## WARNING

Do not operate the tractor if the interlock system is malfunctioning because it is a safety device, designed for protection.

1. Place the PTO lever in the "OFF" position.
2. Depress the clutch-brake pedal.
3. Place the speed control lever (hydrostatic models) or the gear selector lever (gear driven models) is in the "NEUTRAL" position.
4. Move the throttle control lever to the "CHOKE" position when engine is cold. Little or no choking is required when engine is warm.
5. Turn ignition key clockwise to the start position and release it as soon as the engine starts. Do not operate the starter more than 30 seconds at any one time. If engine does not start within this time, turn the key off and wait a few minutes, then try again.
6. After engine starts, slowly move the throttle lever from "CHOKE" to the "FAST" position.

## STOPPING THE ENGINE

Turn the ignition key to the left to the "OFF" position. Remove the key to prevent accidental starting.

**NOTE:** A brief break-in period is essential to ensure maximum engine and mower life. The break-in consists of running the engine at half speed for a period of time required to use one tank of gasoline. It is also recommended to change crankcase oil after the first 5 hours of operation.

## DRIVING THE TRACTOR



### WARNING

Until you have the feel of your lawn tractor, go slowly at first, avoid sharp turns at high speed, and on steep slopes to avoid an upset or loss of control.

### Hydrostatic Models 282 and 383

1. Release the clutch-brake pedal.
2. Start the tractor in motion by moving the speed control lever slowly forward or rearward to desired speed.

**NOTE:** It is recommended that to start the tractor in motion and to change speed and direction, use **ONLY** the speed control handle. The clutch-brake pedal can be used to stop the machine, but machine operates more effectively by engaging the clutch with the speed control in neutral and then move the speed control lever to put the machine in motion.

### Transaxle Models 182 and 382

1. Depress the clutch-brake pedal and select the desired gear.

**NOTE:** Do not force the gear selector lever!

2. Start the tractor in motion by **SLOWLY** releasing the clutch pedal.

## OPERATING THE MOWER

1. Set the desired cutting height with lift handle.
2. The mower blades may be engaged while the lawn tractor is moving or standing still. Engage the mower blades by moving the PTO lever **SLOWLY** forward to the "ON" position. To stop the mower blades pull the lever back to the "OFF" position.



### WARNING

When the PTO lever is engaged, keep feet and hands away from the discharge opening, the blades or any part of the deck.

3. The operator must remain in tractor seat at all times. If operator should leave tractor seat without turning off the PTO lever the engine will automatically shut off.
4. PTO lever must be in the "OFF" position when shifting the tractor into reverse or the engine will shut off automatically.

**IMPORTANT:** If you strike a foreign object, stop the engine. Remove wire from spark plug and keep the wire away from the plug. Thoroughly inspect the mower for any damage, and repair the damage before restarting and operating the mower.

## STOPPING THE TRACTOR

### Hydrostatic Models 282 and 383

To stop the tractor, pull the speed control lever into "NEUTRAL" (N) or depress the clutch-brake pedal.

**NOTE:** The speed control lever will not return to neutral when the clutch-brake pedal is depressed.

### Transaxle Models 182 and 382

The lawn tractor is brought to a stop by depressing the clutch-brake pedal. The drive belt will be disengaged and the brake will be applied.



### CAUTION

Do not leave the seat of the lawn tractor without depressing the clutch-brake pedal and setting the brake lock. If the unit is not to be used for a long period, place the speed control lever (hydrostatic) or the gear selector lever (gear drive) into neutral (N), stop the engine and remove the key.

## ADJUSTMENTS

### SEAT ADJUSTMENT

Before starting the tractor, adjust the seat to the most comfortable driving position. To adjust the seat, loosen the four hex bolts holding the seat to the tractor frame and slide the seat forward or back to the desired position. See figure 9.

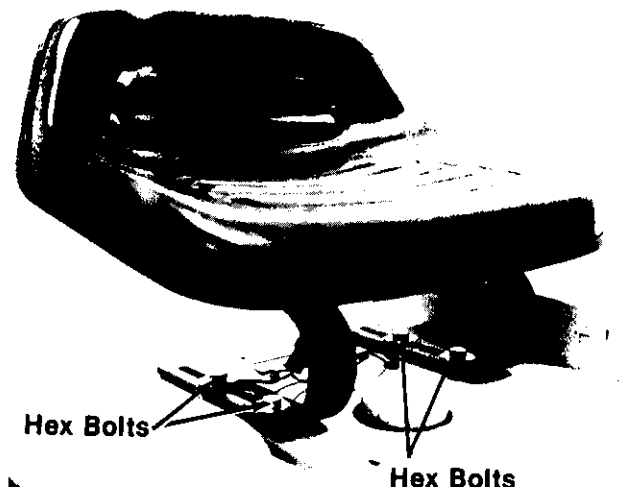

FIGURE 9.

## WHEEL ALIGNMENT

The front wheels should toe-in approximately 1/8". Measure the distances A and B on the front wheels. See figure 10.

**NOTE:** Dimension B should be approximately 1/8 inch less than dimension A.

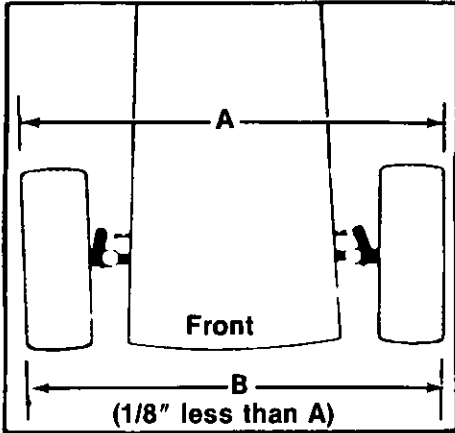

FIGURE 10.

To adjust the toe-in remove one ball joint, loosen the lock nut "C" at the ball joint and turn the tie rod ball joint in or out as required. See figure 11.

- A.) To increase Dimension "B", screw tie rod into tie rod end.
- B.) To decrease Dimension "B", unscrew tie rod from tie rod end.
- C.) Reassemble tie rod. Check dimensions. Re-adjust if necessary.

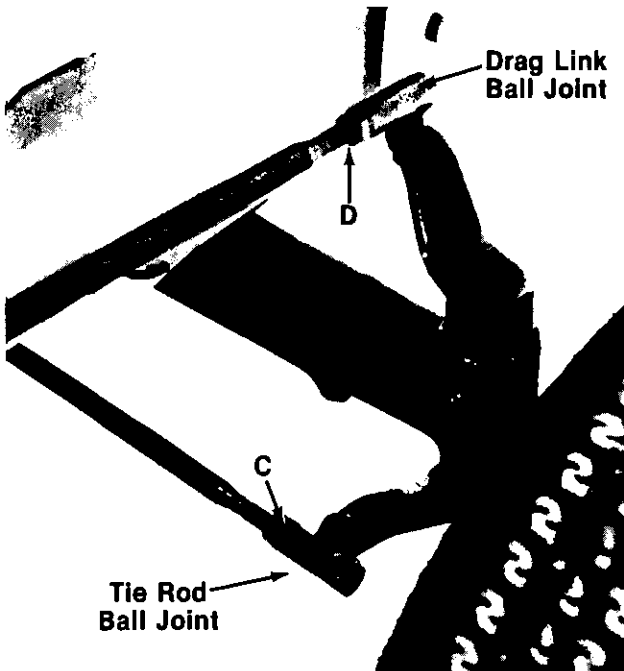

FIGURE 11.

## TURNING RADIUS

The front wheels should have an equal angle for left and right turns. If adjustment is necessary, remove ball joint and loosen lock nut "D", turn the drag link ball joint clockwise or counterclockwise as required. See figure 11.



### CAUTION

Be sure all parts are reassembled securely.

## CARBURETOR ADJUSTMENTS



### WARNING

If any adjustments are made to the engine while the engine is running (e.g. carburetor), disengage all clutches and blades. Keep clear of all moving parts and be careful of heated surfaces and muffler.



### CAUTION

To avoid injury or an accident, be sure the brake pedal is in the locked position, transmission is in neutral, and any equipment is disengaged before starting engine to make carburetor adjustments.

Minor carburetor adjustment may be required to compensate for differences in fuel, temperature, altitude and load. To adjust the carburetor, turn needle valve clockwise until it just closes. See figure 12.



### CAUTION

Valves may be damaged by turning them too far.

Open needle valve 1-1/8 turns counterclockwise. Close idle valve in same manner and open 1-1/8 turn. See figure 12. This initial adjustment will permit the engine to be started and warmed up prior to final adjustment.

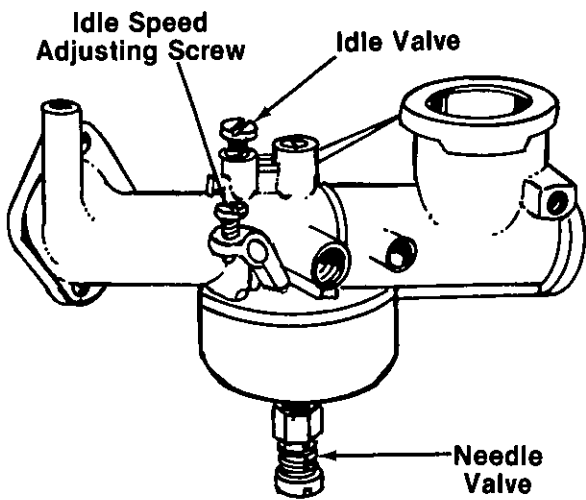

FIGURE 12.

### Final Adjustment

Place throttle control lever in "FAST" position. Turn needle valve in until engine slows (clockwise—lean mixture). Then turn it out past smooth operating point (rich mixture). Now turn needle valve to midpoint between rich and lean. Next, adjust idle RPM. Rotate throttle counterclockwise and hold against stop. Adjust idle speed adjusting screw to obtain 1750 RPM. Holding throttle against idle stop, turn idle valve in (lean) and out (rich). Set at midpoint between rich and lean. Re-check idle RPM. Release throttle. If engine will not accelerate properly, the carburetor should be readjusted, usually to a slightly richer mixture.

### BRAKE ADJUSTMENT

During normal operation of this machine, the brake is subject to wear and will require periodic examination and adjustment.



### CAUTION

Do not have the engine running when you adjust the brake.

### Transaxle Models 182 and 382

**NOTE:** Lawn tractor is shown with the wheel removed for clarity.

To adjust the brake, proceed as follows.

1. Tighten the inside nut until the cam lever can not be moved by hand.
2. Loosen the inside nut until the cam lever can be pushed forward so that there is a 1/8" to 3/16" space between the cam lever and stop bolt. See figure 13.

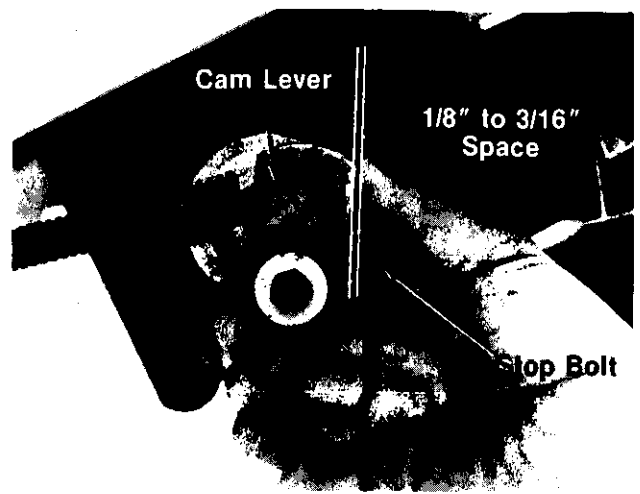

FIGURE 13.

3. Tighten the outside nut against the inside nut, using two 1/2" wrenches. See figure 14.

**NOTE:** Friction pads must be replaced when the inside of cam lever touches the housing.

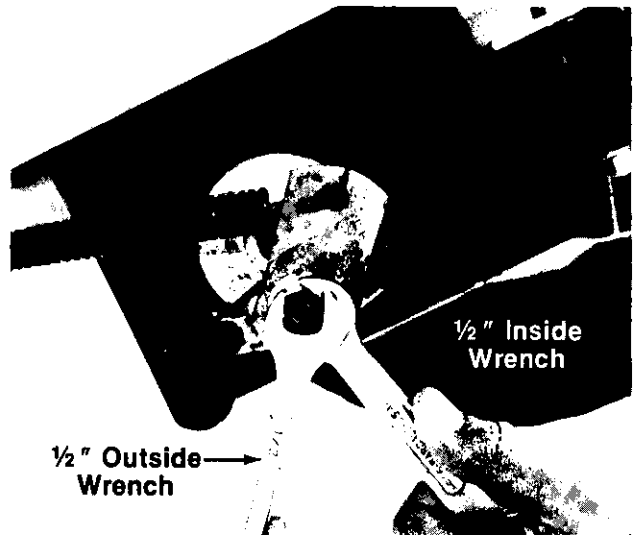

FIGURE 14.

### Hydrostatic Models 282 and 383

With the brake pedal in the up position (10 degrees from vertical) and all slack taken out of the linkage, adjust brake adjusting nut to allow 5/16 to 3/8-inch clearance between nut and arm. See figure 15.

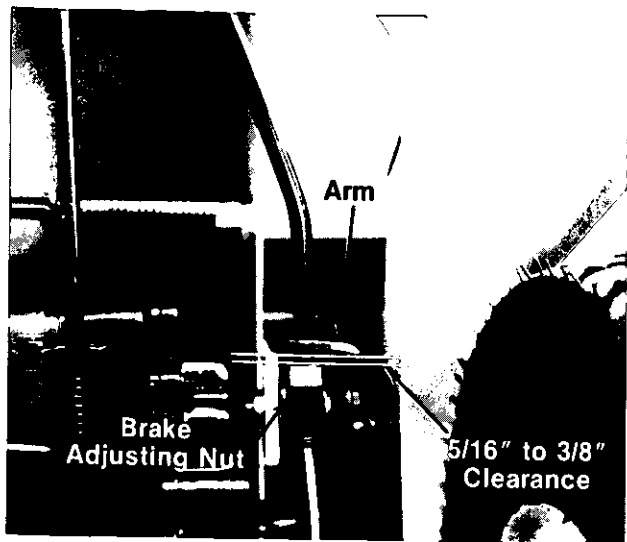

FIGURE 15.

### LEVELING THE MOWER

A properly leveled mower is one where the blades are cutting parallel to the ground. Should level adjustment be necessary due to tire variation or wear, proceed as follows:

1. Drive the lawn tractor onto a hard flat surface.
2. Turn the ignition off and disconnect the high tension wire to the spark plug. Lock the tractor brake.
3. Measure the distance from the ground to the blades (blades parallel to centerline of tractor) front, rear and sides in typical cutting height.

### Leveling the Mower From Front to Rear

1. Disconnect the mower linkage rod from the front foot rest support bracket by removing the quick attachable pin and rod pin through the clevis. See figure 16.

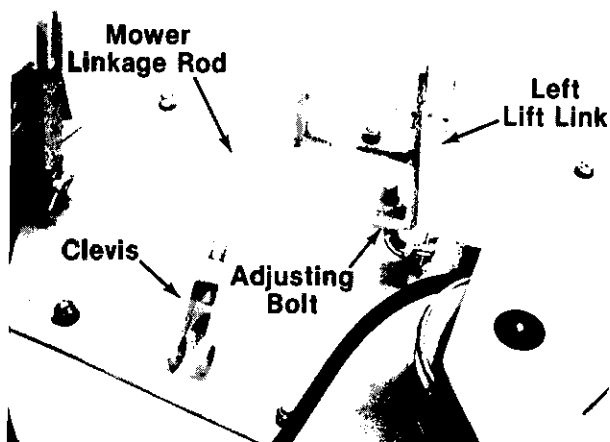

FIGURE 16.

2. Adjust the clevis on the end of the mower linkage rod either up or down, depending on which measures high. See figure 16.
3. Reassemble the mower linkage rod to the front rest support bracket. Readjust if necessary.

**NOTE:** Figure 16 is shown with deck removed from the lawn tractor for clarity purposes, only.

### Leveling the Mower From Side to Side

The left lift link is adjustable should the mower require side to side adjustment.

1. Remove the klick pin from the adjusting bolt and remove the left lift link assembly from the deck. See figure 16.
2. Turn the adjusting bolt up or down depending on which side measures too high.
3. Reassemble left lift link assembly to deck. Readjust if necessary.

## LUBRICATION GUIDE

The symbols indicate the method of application and the hourly intervals to apply the lubricant. See figure 17 or 18.



Use a pressure lubricating gun and apply IH 251H EP grease (or equivalent No. 2 multi-purpose lithium grease) sufficient to flush out the old grease and dirt. Lubricate at hourly intervals indicated on symbols.



Use oil can at hourly intervals shown on symbols. Use IH No. 1 engine oil.



At hourly intervals shown on symbols remove the crankcase drain plug and drain the oil from the crankcase while the engine is warm. Replace drain plug and refill with new oil to the point of overflowing.



Check the oil level at hourly intervals shown on symbols. If the level is low, add the specified lubricant to bring up the proper height.

The specific areas which require lubrication are shown on the following illustrations. A list is provided and is numbered to correspond with each illustration.

### Transaxle Models 182 and 382

The transaxle is lubricated and sealed at the factory and does not require checking. If disassembled for any reason, lubricate with 24 oz. of E.P. Lithium grease.

## HYDROSTATIC MODELS 282 and 383

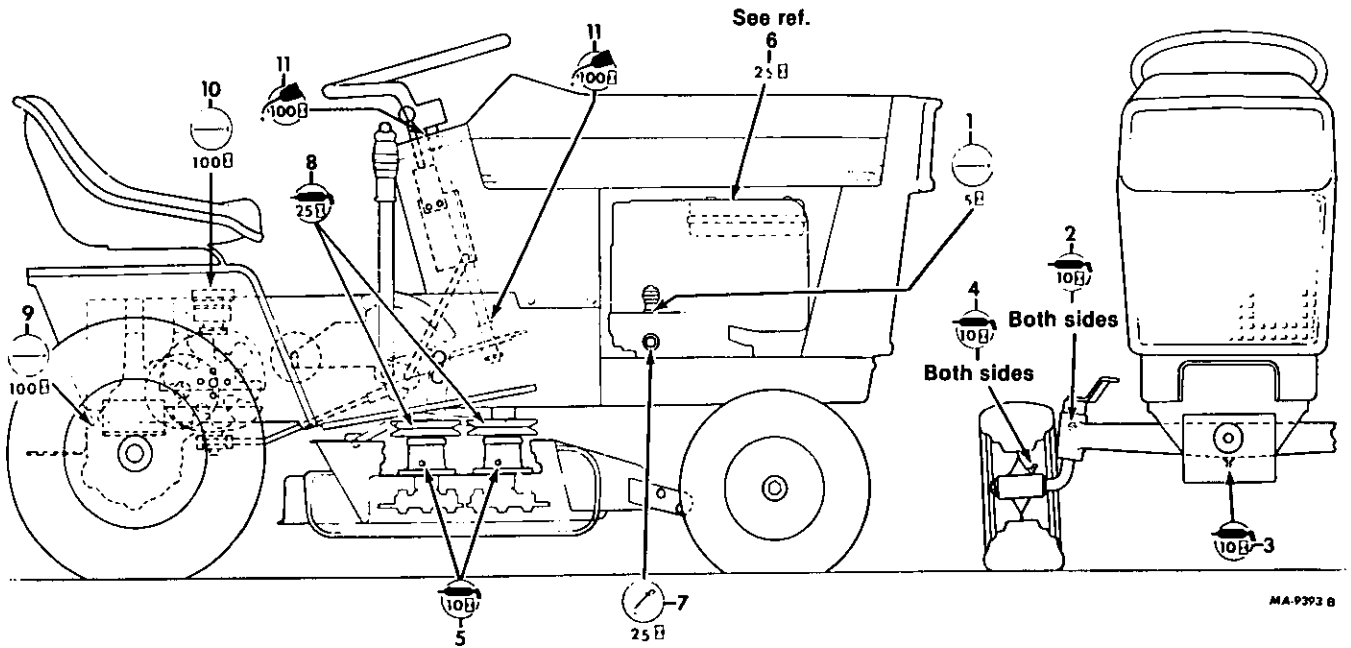

FIGURE 17.

## TRANSAXLE MODELS 182 and 382

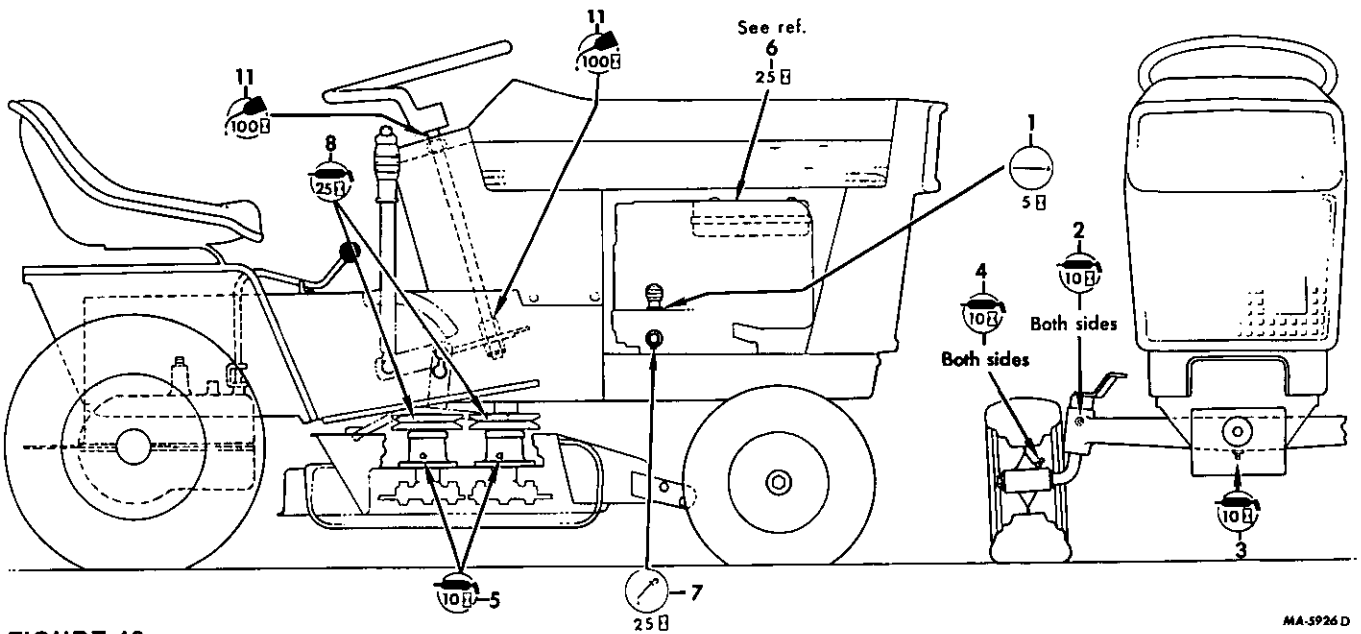

FIGURE 18.

1. Oil filler cap and oil minder  
NOTE: Check the oil level only while the engine is stopped. Refer to "Maintenance."
2. Steering knuckles (2)
3. Front axle pivot pin
4. Front wheels
5. Mower spindle bearings (2)
6. Air cleaner  
Refer to "Maintenance."
7. Engine crankcase drain plug  
NOTE: Refer to "Lubrication Table."
8. Mower pulleys (2)
9. Gear reduction drive (Hydrostatic Models)  
NOTE: Refer to "Lubrication Table."
10. Hydrostatic drive  
NOTE: When cold, 2-inches from top, when hot, 3/4-inch from top.
11. Steering wheel bushings (2)  
NOTE: Apply two or three drops of light oil and rotate the steering wheel to distribute the oil.

# MAINTENANCE



**WARNING**

Disconnect the spark plug wire and ground against the engine before performing any repairs or maintenance.

## CRANKCASE OIL

1. Check oil level regularly—after each five hours of operation. **BE SURE OIL LEVEL IS MAINTAINED.**
2. Change oil after first five hours of operation. Thereafter change every 25 hours of operation. Remove oil drain plug and drain oil while engine is warm. Replace drain plug. Remove oil fill plug, oil minder or dipstick and refill with new oil of proper grade. Replace oil fill plug, oil minder or dipstick.

## TO FILL SUMP WITH OIL

Place engine level. Clean area around oil fill before removing oil minder.

Remove oil minder. Fill crankcase to point of overflowing. **POUR SLOWLY.** Capacity 2¼ to 3 pints. Replace oil fill plug or oil minder.

Use a high quality detergent oil classified "For Service SC, SD, SE or MS." Detergent oils keep the engine cleaner and retard the formation of gum and varnish deposits. Nothing should be added to the recommended oil.

## RECOMMENDED SAE VISCOSITY GRADES

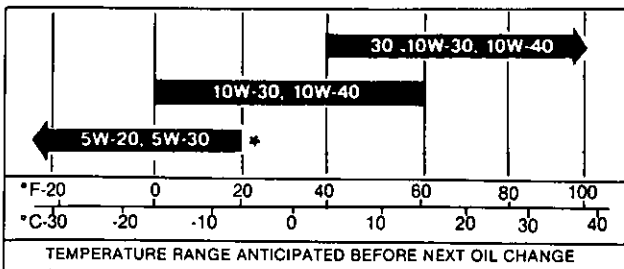

\*If not available, a synthetic oil may be used having 5W-20, 5W-30 or 5W-40 viscosity.

## STANDARD OIL FOAM AIR CLEANER

Clean and re-oil foam element at three month intervals or every 25 hours, whichever occurs first.

**NOTE:** Service more often under dusty conditions.

### To Service Air Cleaner (Refer to Figure 19)

1. Remove two screws and lift off complete air cleaner assembly.

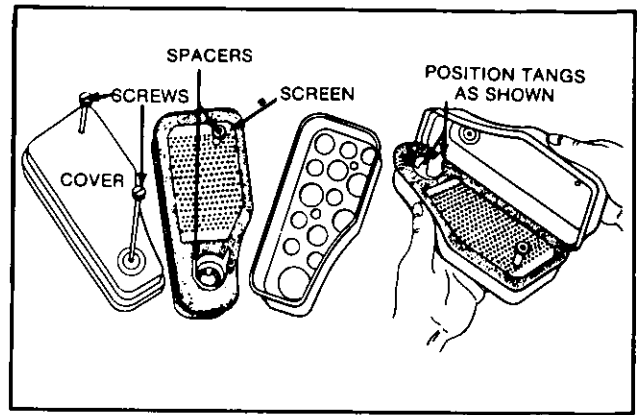

**FIGURE 19.**

2. Remove screen and spacers from foam element.
3. Remove foam element from air cleaner body.
4. a. Wash foam element in liquid detergent and water to remove dirt.  
b. Wrap foam in cloth and squeeze dry.  
c. Saturate foam in engine oil. Squeeze to distribute and remove excess oil.  
d. Assemble parts—securely fasten to carburetor with screws.

When assembling make certain the lip of the foam element extends over edge of the air cleaner body. The foam element lip will form a protective seal.

## CLEANING ENGINE AND BLADE HOUSING

Any fuel or oil spilled on the machine should be wiped off promptly. Grass, leaves, and other dirt must not be left to accumulate around the cooling fins of the engine or on any part of the machine.

Clean the underside of the blade housing after each mowing.

## SPARK PLUG

Clean and reset gap at .030" every 100 hours of operation.



**CAUTION**

Do not blast clean spark plug. Spark plug should be cleaned by scraping or wire brushing and washing with a commercial solvent.

## MOWER DECK REMOVAL

To facilitate changing the blades, sharpening the blades, cleaning, etc., the mower may be detached as follows:

Place the mower clutch control lever in the "OFF" position. Stop the engine and disconnect the spark plug wire.

1. Disconnect the mower drive belt from the main drive pulley and clutching idler pulley. The belt guide around the main drive pulley is spring hooked for ease in removing the belt. See figure 20.

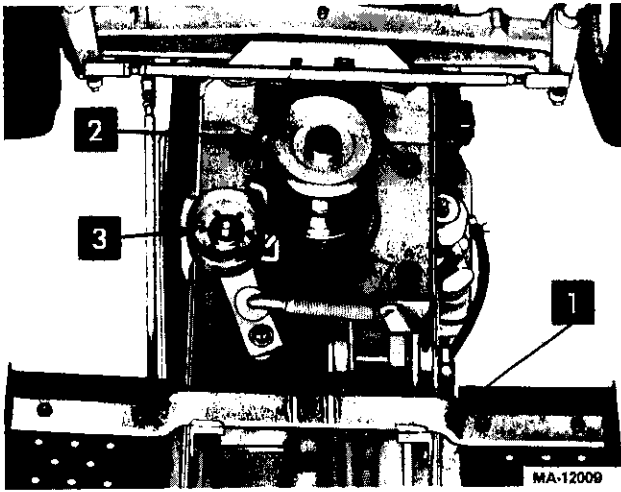

**FIGURE 20.**

1. Front foot rest support bracket
2. Main drive pulley and belt guide
3. Mower drive belt idler

2. Position the mower in the lowest position.
3. Disconnect the mower linkage rod from the front foot rest support bracket by removing the quick attachable pin and rod pin through the clevis. See figure 21.

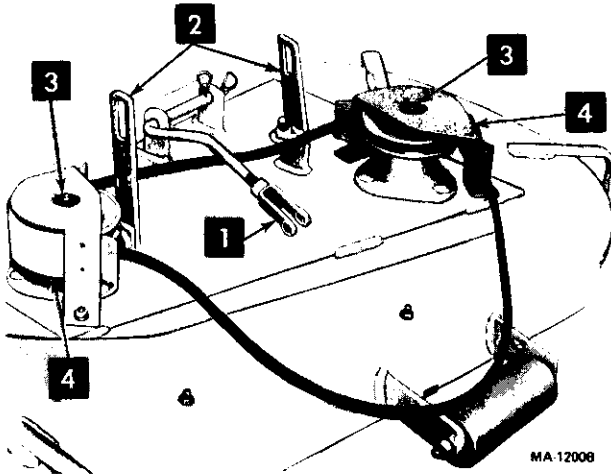

**FIGURE 21.**

1. Mower linkage rod and clevis
  2. Lift links
  3. Lubrication fittings
  4. Belt guides
4. Detach the front mower leveling link from the front hanger bracket and the front of the mower by removing the pins which are held by klik pins. See figure 22.

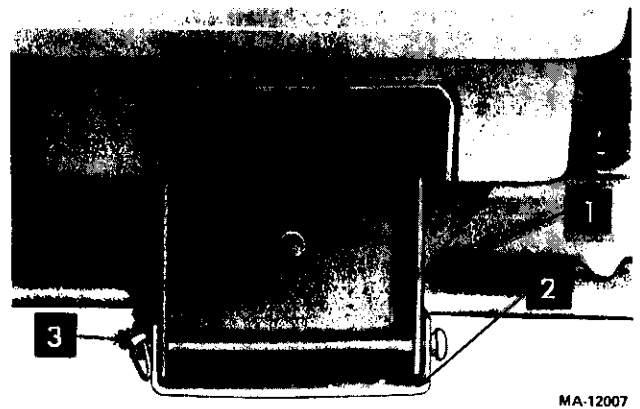

**FIGURE 22.**

1. Front mower hanger bracket
  2. Front mower leveling link
  3. Klik pin
5. Raise the mower by hand, first on one side and then the other, to disconnect the mower lift links from the mower. See figure 23.

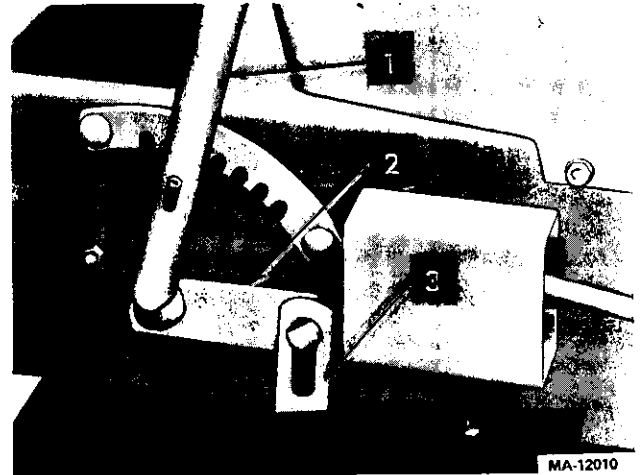

**FIGURE 23.**

1. Lift handle
2. Lift arm
3. Lift link (one on each side)

To attach the mower to the lawn tractor, reverse the above procedure.

## CUTTING BLADES

### A. Removal for Sharpening or Replacement



**WARNING**

Be sure to disconnect and ground the spark plug wire and remove ignition key before working on the cutting blade to prevent accidental engine starting.



1. Remove the large bolt and lock washer which holds the blade and adapter to the blade spindle.
2. Remove the blade and adapter from the spindle. Be careful not to lose the key on the spindle.
3. If the blade or blade adapter needs replacing, remove the two small bolts, lock washers and nuts which hold the blade to the adapter.

### B. Sharpening

Remove the cutting blade by following the directions of the preceding section.

When sharpening the blade, follow the original angle of grind as a guide. It is **extremely important** that each cutting edge receives an equal amount of grinding to prevent an unbalanced blade. An unbalanced blade will cause excessive vibration when rotating at high speeds, may cause damage to the mower and could break, causing personal injury.

The blade can be tested for balance by balancing it on a round shaft screwdriver. Remove metal from the heavy side until it balances evenly.

**NOTE:** It is recommended that the blade always be removed from the adapter for the best test of balance.

### C. Reassembly

Before reassembling the blade and the blade adapter to the unit, lubricate the spindle and the inner surface of the blade adapter with light oil. Lubricating the bolt holes, bolts and inner surface of the nuts with light oil is also recommended.

### MOWER DECK BELT REMOVAL

1. Remove the mower deck from the lawn tractor. Refer to "Mower Deck Removal."
2. Remove the two belt guides from the mower housings. See figure 24.

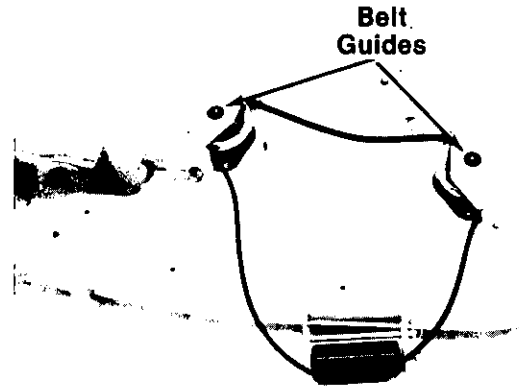

FIGURE 24.

3. Remove and replace the mower drive V-belt.
4. Reassemble the belt guides to the deck making sure that the belt guides do not rub against the mower pulleys.

**NOTE:** When installing a new belt, make certain that the belt runs correctly between the pulleys and the belt guides. See figure 25.

### BELT REMOVAL AND REPLACEMENT



#### CAUTION

Do not use an off-the-shelf belt. If belt replacement is required, order belt or belts by part number from your nearest authorized dealer.



#### WARNING

To avoid an accident or possible injury, always stop the engine, disconnect the high tension wire to the spark plug, and lock the brake before doing any work on the machine.

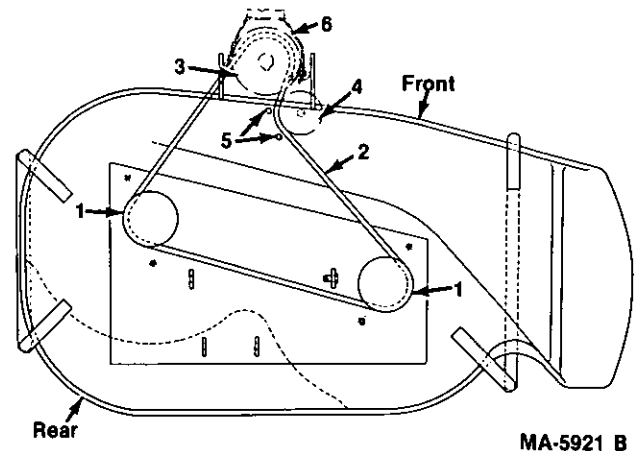

FIGURE 25.

1. Mower blade spindles
2. Mower drive belt
3. Mower drive pulley
4. Mower drive belt pulley idler
5. Belt guides
6. Belt guide

## Hydrostatic Drive Belt Removal (Models 282 and 383)

1. Remove the mower deck.
2. Disconnect the mower drive belt idler. See figure 26.

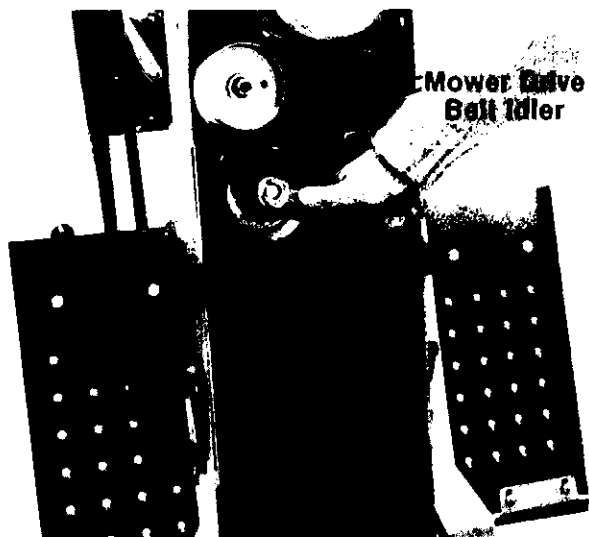

FIGURE 26.

3. Pushing the hydrostatic belt idler pulley, pull the belt away from pulley, and release the pulley. See figure 27.



FIGURE 27.

4. Slip the belt off the intermediate drive pulley and hydrostatic pulley. See figure 28.

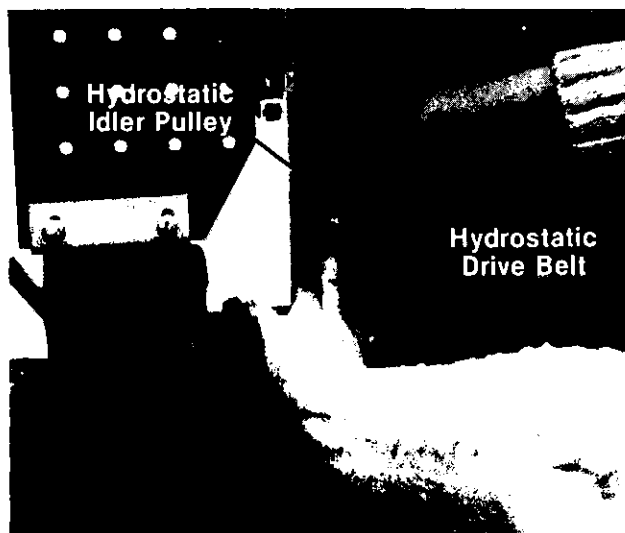

FIGURE 28.

5. Replace with a new belt in reverse order.

## Crankshaft Main Drive Belt (Hydrostatic Models 282 and 383)

1. Remove the mower deck.
2. Remove the hydrostatic drive belt.
3. Remove the main drive belt idler pulley. See figure 29.

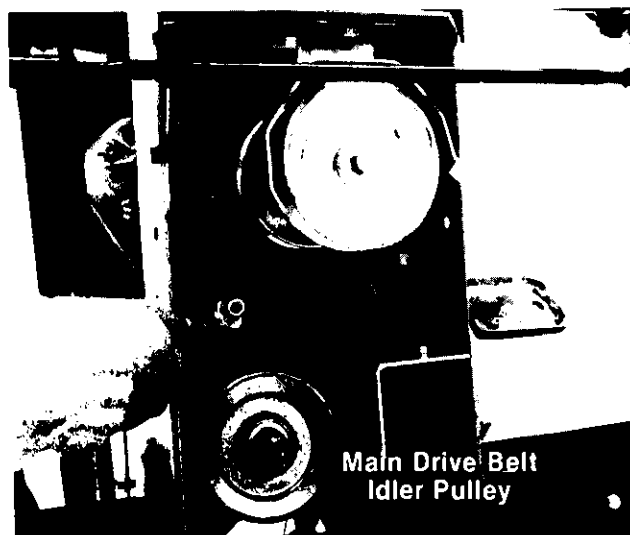

FIGURE 29.

4. Slip the crankshaft main drive belt from the intermediate drive pulley and the crank shaft main drive pulley. See figure 30.

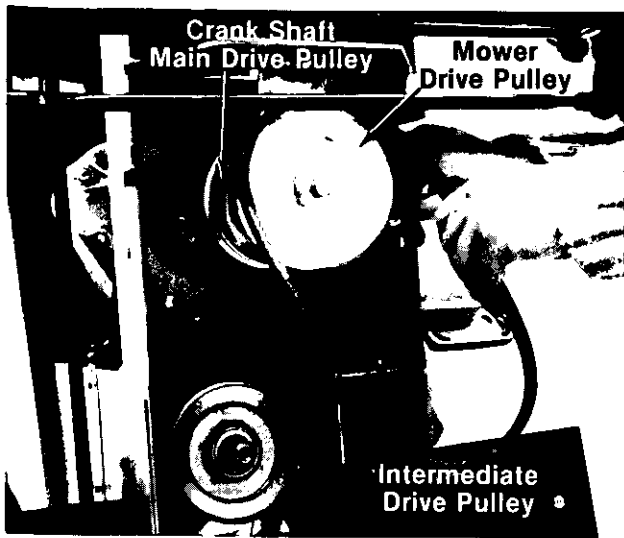

FIGURE 30.

5. Push the belt guide away from the mower drive pulley and slip the belt over mower drive pulley. See figure 31. Replace belt.
6. Idler belt guide tab must be positioned in hole in idler arm upon reassembly. See figure 33.

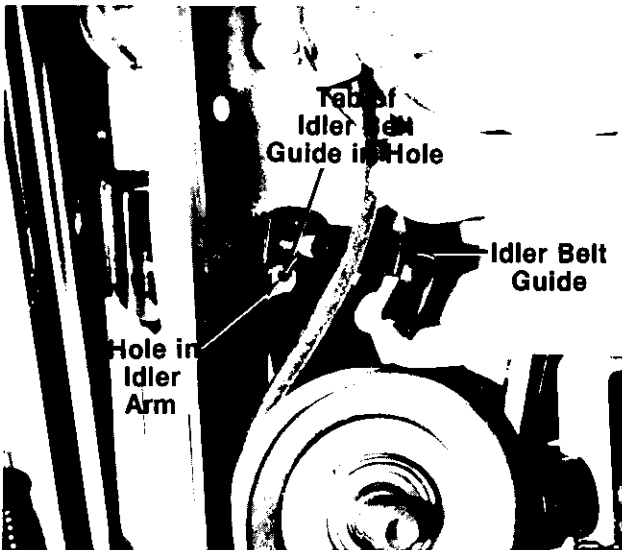

FIGURE 31.

7. Upon reassembly of idler pulley, be certain hub side of idler goes against the idler bracket. See figure 32.

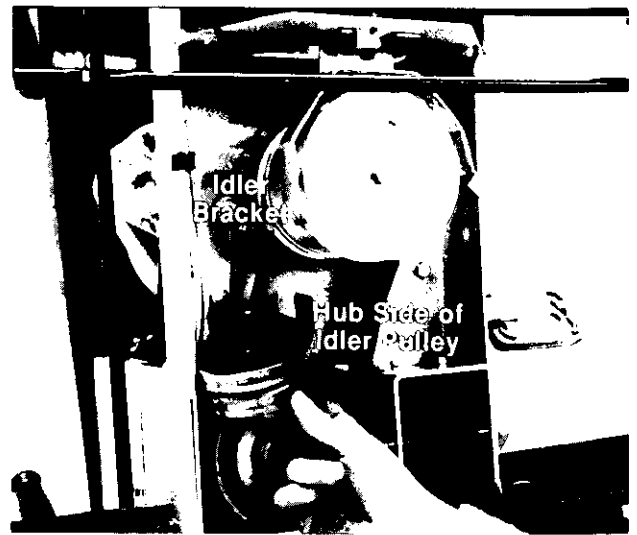

FIGURE 32.

8. When sliding the idler pulley on the idler bracket, be certain the belt is between the pulley and the belt guide.

**NOTE:** Be certain all belts are inside belt guards and keepers.

#### Transaxle Main Drive Belt (Models 182 and 382)

1. Remove mower deck.
2. Disconnect the gear shift bracket from the transaxle. See figure 33.

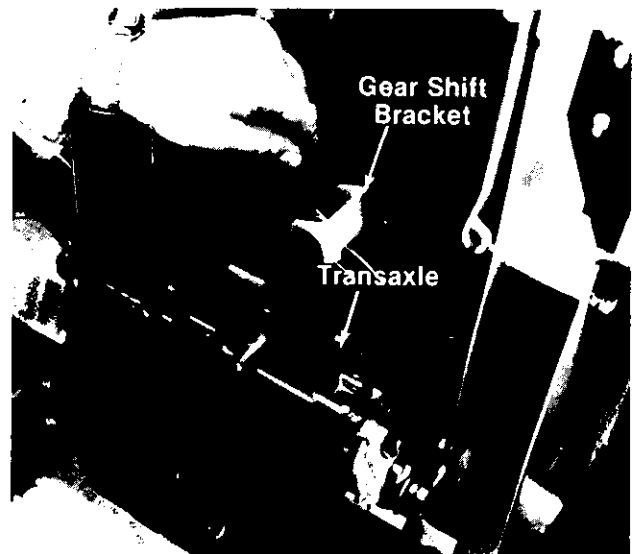

FIGURE 33.

3. Slip the belt away from the idler pulleys. See figure 34.

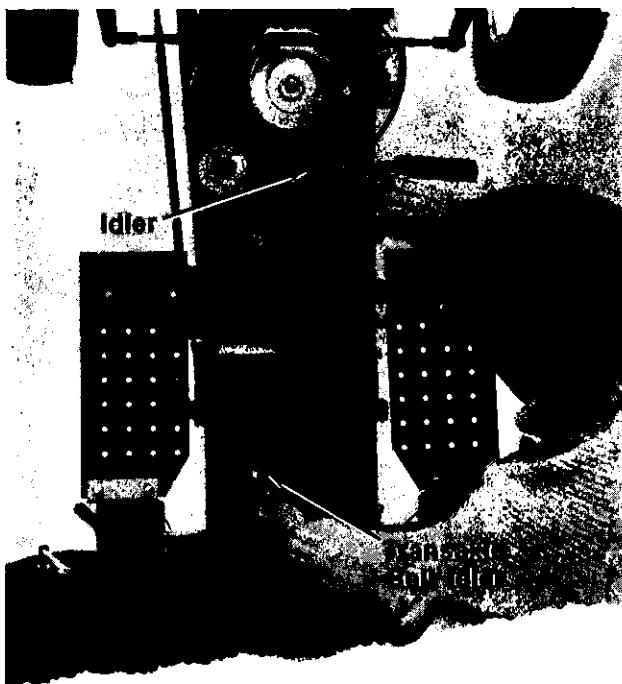

FIGURE 34.

4. Push back belt guide and slip the belt over the drive pulley. See figure 35.

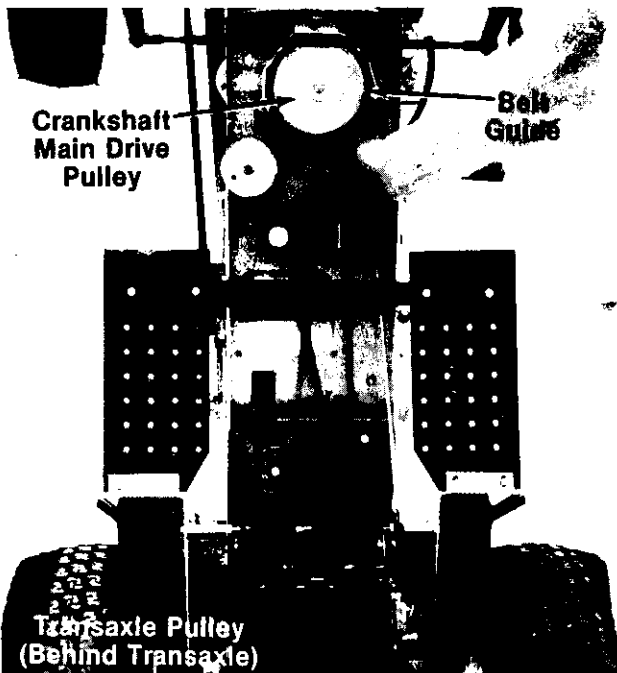

FIGURE 35.

5. Slip the belt off the transaxle pulley.
6. Replace belt in reverse order.

**NOTE:** Be certain all belts are inside belt guides.

## BATTERY INFORMATION



**WARNING**

- A. Battery acid must be handled with great care as contact with it can burn and blister the skin. It is also advisable to wear protective clothing (goggles, rubber gloves and apron) when working with it.\*
- B. Should battery acid accidentally splatter into the eyes or onto the face, rinse the affected area immediately with clean cold water. If there is any further discomfort, seek prompt medical attention.
- C. If acid spills on clothing, first dilute it with clean water, then neutralize with a solution of ammonia/water or baking soda/water.
- D. Since battery acid is corrosive, do not pour it into any sink or drain. Before discarding empty electrolyte containers, rinse them with a neutralizing solution.
- E. NEVER connect or disconnect charger clips to battery while charger is turned on as it can cause sparks.
- F. Keep all lighted materials (cigarettes, matches, lighters) away from the battery as the hydrogen gas generated during charging can be combustible.
- G. As a further precaution, only charge the battery in a well-ventilated area.

\*Always shield eyes, protect skin and clothing when working near batteries.



**DANGER**

BATTERIES CONTAIN SULFURIC ACID AND MAY CONTAIN EXPLOSIVE GASES (when electrolyte has been added).

KEEP BATTERIES OUT OF THE REACH OF CHILDREN.

## MAINTENANCE OF BATTERY

1. Check electrolyte level periodically (at least every two weeks). Keep the level to the split rings. Use only distilled water or a good quality drinking water. Never add acid or any other chemicals to the battery after initial activation.

2. The battery should be checked with a hydrometer after every 25 hours of operation. If the specific gravity is less than 1.225, the battery should be recharged. Maximum charge rate 5 AMPS.
3. Coat the terminals and exposed wire with a thin coat of grease or petroleum jelly for longer service and protection against corrosion.
4. The battery should be kept clean. Any deposits of acid should be neutralized with baking soda and water. Be careful not to get this solution in the cells.
5. Avoid tipping the battery. Even a "sealed" battery will leak electrolyte when tipped.

### STORAGE OF THE BATTERY

1. When storing battery for extended periods, disconnect battery cables. Removing battery from unit is recommended.
2. Keep the exterior of the battery clean, especially the top. A dirty battery will discharge itself.
3. Check the battery with a hydrometer. The battery must be stored with a full charge. A discharged battery will freeze.

Specific Gravity	Freezing Point
1.265	-71° F.
1.250	-62° F.
1.200	-16° F.
1.150	5° F.
1.100	16° F.



### CAUTION

All batteries discharge during storage.

4. Recharge battery whenever the specific gravity is less than 1.225, before returning to service or every two months, whichever comes first.

### COMMON CAUSES FOR BATTERY FAILURE

1. Overcharging
2. Undercharging
3. Lack of water
4. Loose hold downs and/or corroded connections
5. Excessive loads
6. Battery electrolyte substitutes
7. Freezing of electrolyte

**NOTE:** These failures do not constitute warranty.

### BATTERY REMOVAL OR INSTALLATION



### WARNING

When removing the battery, follow this order of disassembly to prevent your wrench from shorting against the frame.

1. Remove the Negative cable.
2. Remove the Positive cable.

To install a battery:

1. Attach the Positive cable.
2. Attach the Negative cable.

### JUMP STARTING

1. Attach the first jumper cable from the Positive terminal of the good battery to the Positive terminal of the dead battery.
2. Attach the second jumper cable from the Negative terminal of the good battery to the **FRAME OF THE UNIT WITH THE DEAD BATTERY.**



### WARNING

Failure to use this starting procedure could cause sparking, and the gases in either battery could explode.

### TIRES

Keep the pneumatic tires properly inflated. Over-inflation will cause operator discomfort. Under-inflation will cause short tire life.

Inflate the front and rear tires for normal or heavy load operations as shown in the following table.

Tire Size	Pounds per square inch
Front Tires	
13 x 5.00-6	12
Rear Tires	
18 x 9.50-8	12

Always see that the tire valve caps are in place and tightened securely to prevent loss of air and protect the valve core and stem.

Do not overload the tractor tires by mounting equipment on the tractor which exceeds the load capacity of the size of the tires on the tractor.

### Mounting Tires On The Rim

After mounting a new or old tire on the rim, inflate it to 20 pounds pressure to seat the tire bead on the rim flange. Then deflate the tire to the correct operating pressure.

# OFF-SEASON STORAGE

If the machine is to be inoperative for a period longer than 30 days, the following procedures are recommended:

1. Working outdoors, drain all fuel from the fuel tank. Use a clean dry cloth to absorb the small amount of fuel remaining in the tank, then run the engine until all fuel in the carburetor is exhausted.
2. Drain all the oil from the crankcase (this should be done after the engine has been operated and is still warm) and refill the crankcase with clean new oil.
3. Disconnect the spark plug wires and remove the spark plugs from the cylinders. Pour about 2 or 3 tablespoons of engine oil into each cylinder, and then turn the engine over several times to spread out the oil. Replace the spark plugs but do not connect the wires.
4. Clean the engine and the entire tractor thoroughly.
5. Lubricate all lubrication points and wipe the entire machine with an oiled rag in order to protect the surfaces.
6. Follow battery storage instructions on page 21.
7. Protect tires and seat from sunlight. Inflate tires at regular intervals.
8. Store tractor in a dry and protected place.

# TROUBLE SHOOTING

## Possible Cause

## Possible Remedy

### LACK OF POWER

Choke partially closed . . . . .	Open choke.
Restricted air filter element . . . . .	Clean or replace element.
Carburetor improperly adjusted . . . . .	Adjust carburetor.
Faulty ignition . . . . .	Check spark plug.*

### HARD TO START OR WILL NOT START

No gasoline in fuel tank or carburetor . . . . .	Fill the fuel tank with non-leaded or regular gasoline and check the carburetor, and fuel shut-off valve.
Engine will not crank . . . . .	The Lawn Tractor has an interlock safety starting system. The mower clutch control must be fully disengaged and the clutch pedal fully depressed. Charge the battery.
Choked improperly, flooded engine . . . . .	Follow starting instructions.
Water in gasoline . . . . .	Drain the fuel tank and carburetor. Use new fuel and dry the spark plug.
Defective ignition or loose wiring . . . . .	Check the wiring and spark plug.
No Spark . . . . .	Check the high tension wire. Charge the battery.
Spark plug dirty or improper gap . . . . .	Clean, adjust the gap to .030 inch, or replace the plug.

### ENGINE OPERATES IRREGULARLY, KNOCKS, OR SMOKES

Spark plug dirty, wrong gap, or wrong type . . . . .	Clean, reset the gap to .030 inch, or replace.
Restricted air cleaner . . . . .	Clean or replace the element.
Running on choke position . . . . .	Move throttle control to fast position.
Carburetor improperly adjusted . . . . .	Adjust carburetor.
Poor or weak spark . . . . .	Check spark plug and wiring.*
Engine smokes . . . . .	Check combination oil filler cap and oil level gauge and be sure cap is securely tightened.
Engine incorrectly timed . . . . .	*

### ENGINE OVERHEATS

Excessive load on engine . . . . .	Reduce excessive load.
Lack of lubrication . . . . .	Fill crankcase to proper level.
Carburetor improperly adjusted . . . . .	Adjust carburetor.
Engine cooling fins plugged . . . . .	Clean out trash.
Engine improperly timed . . . . .	*

### FREQUENT BATTERY DISCHARGE

Wiring . . . . .	Check all wire terminals for looseness.
Battery . . . . .	Replace battery if necessary.

### HYDROSTATIC UNIT OVERHEATS

Fan blades broken . . . . .	Replace fan.*
Fan blades excessive wear . . . . .	*

**\*See your authorized dealer.**

# SPECIFICATIONS

	182 Cadet	282 Cadet	382 Cadet	383 Cadet
<b>CAPACITIES (Approximate)</b>	1 Gallon			
Fuel Tank .....	2¼ Pints		3 Pints	
Crankcase .....	2¾ Pints		2¾ Pints	
Transmission	1½ Pints		1½ Pints	
Gear Drive .....	2¾ Pints			
Hydrostatic .....	2¾ Pints			
Differential .....	2¾ Pints			
<b>ENGINE</b>	Briggs and Stratton 191707		Briggs and Stratton 252707	
Make and Model .....	One			
Number of Cylinders .....	3-inch		3-7/16-inch	
Bore .....	2¾-inch		2¾-inch	
Stroke .....	19.4 cu. in.		24.3 cu. in.	
Displacement .....	1800 RPM			
Engine speed (Governed)	3600 RPM			
Minimum speed .....	.005-.007-inch			
Maximum no load speed	.009-.011-inch			
(High Idle) .....	Magneto			
Valve clearance (Engine Cold)	.030-inch			
Intake .....	.020-inch			
Exhaust .....	Negative			
<b>ELECTRICAL SYSTEM</b>	Suction lift			
Ignition .....	36-inch			
Spark plug gap	1½ to 4¼-inch			
(Champion RCJ-8 or equivalent) .....	V-belt with clutch			
Breaker point gap .....	13 x 5.00-6			
Battery terminal grounded .....	18 x 9.50-8			
<b>GENERAL</b>	12 lbs./sq. inch			
Type cutter bar .....	68-inches			
Width of cut .....	42½-inches			
Adjustable cutting height (Approx.) .....	64-inches			
Mower drive .....	470 lbs.		480 lbs.	
Tire sizes				
Front—2 ply tubeless .....				
Rear—2 ply tubeless .....				
Tire inflation pressure .....				
Turning radius .....				
Wheel base .....				
Length overall .....				
Weight (Approx.) .....				

## GROUND SPEEDS

### HYDROSTATIC DRIVE MODELS

Speed: Forward .....	.0 to 5.5 mph
Reverse .....	.0 to 2.35 mph

### GEAR DRIVE MODELS

Speed: 1st .....	1.6 mph
2nd .....	2.6 mph
3rd .....	3.9 mph
4th .....	4.9 mph
5th .....	5.8 mph
Reverse .....	1.9 mph



## Free Manuals Download Website

<http://myh66.com>

<http://usermanuals.us>

<http://www.somanuals.com>

<http://www.4manuals.cc>

<http://www.manual-lib.com>

<http://www.404manual.com>

<http://www.luxmanual.com>

<http://aubethermostatmanual.com>

Golf course search by state

<http://golfingnear.com>

Email search by domain

<http://emailbydomain.com>

Auto manuals search

<http://auto.somanuals.com>

TV manuals search

<http://tv.somanuals.com>