

Cuisinart®



Instruction Booklet

Premier™ 11-Cup Series

For your safety and continued enjoyment of this product, always read the instruction book carefully before using.
Download from [Www.Somanuals.com](http://www.somanuals.com). All Manuals Search And Download.

Recommended work bowl capacity for various foods

FOOD	CAPACITY
Chopped Fruits and Vegetables	11 cups processed food
Chopped or Puréed Meat, Poultry, Fish or Seafood	1-3/4 pounds meat, cut in 1-inch or smaller cubes, chilled
Bread Dough	5 cups all-purpose flour yielding two 1-1/4 pound loaves 2-1/2 cups each all-purpose and whole wheat flour, yielding two 1-1/4 pound loaves 2-3/4 cups whole grain flours (no white flour added) for custom recipes
Pizza Dough	4-1/2 cups all-purpose flour, yielding 2-1/2 pounds pizza dough (dough to make up to four 12 – 14-inch pizzas)
Nuts for Nut Butters	2 – 4 cups nuts (10 – 20 ounces)
Sliced or Shredded Cheese, Fruit, or Vegetables	11 cups (total processed weight varies by food)
Cake Batter	1 18.5 ounce standard packaged cake mix, or homemade batter recipe for four 8-inch layers
Thin Liquids (such as custard for quiche or cheesecake batter)	2-3/4 cups
Thick Liquids	5 – 6 cups
Puréed Cooked Fruits And Vegetables	8 cups cooked, yielding approximately 5-1/2 to 6 cups thick purée
Puréed Soft Fresh Fruits (berries, kiwis, peaches, etc.)	8 cups fresh, yielding approximately 5 to 6 cups purée

IMPORTANT UNPACKING INSTRUCTIONS

This package contains a Cuisinart® Premier™ Series Food Processor, and the standard parts for it:

PowerPrep® metal dough blade, metal chopping blade, slicing disc, shredding disc, detachable stem for discs, spatula, recipe and instruction books, and how-to video.

CAUTION:

THE CUTTING TOOLS HAVE VERY SHARP EDGES.

To avoid injury when unpacking the parts, please follow these instructions:

1. Place the box on a low table or on the floor next to the kitchen counter or table where you intend to keep the food processor. Be sure the box is right side up.
2. Open top flaps and remove the cardboard insert. You will see a rectangular block of plastic foam that holds the processor parts, each fitted into a cavity of the foam.
3. The PowerPrep® metal dough blade (A) and detachable stem for the discs (B) are in cavities on one short side of the foam block. Remove them first.
4. The plastic spatula (C) is on the adjacent long side of the foam block. Remove it next.

5. The slicing disc (D) is on the edge of one of the long sides of the foam block; the shredding disc (E) is on the other side. Slide them out of their grooves **WITH GREAT CARE; THE BLADES ARE VERY SHARP.**
6. Only the work bowl cover (F) and pusher assembly (G) now remain in the foam block. Grasp an edge of the work bowl cover and pull it straight up. The pusher assembly will slide away from the work bowl cover and remain in place. Lift it straight up to remove.
7. Lift out the foam block.
8. Remove the instruction book.
9. Lift out the video from its space in the cardboard frame on one side of the box. Then lift out the cardboard frame.
10. The housing base and work bowl with metal blade are at the bottom of the box. The metal blade is loose in the

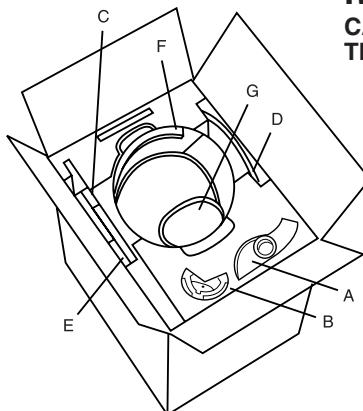

work bowl. Do not turn over work bowl without first removing metal blade.

11. Remove the base and bowl together by grasping the plastic bowl at the top with both hands and lifting the bowl straight up. Do not rotate the bowl clockwise on the base. This will cause the bowl to separate from the base.
12. Place the food processor on a counter or table and read the instructions thoroughly before using the machine.
13. Save the shipping cartons and plastic foam blocks. You may want to use them at a later date.

Please watch the enclosed how-to video before using the food processor.

NOTE: Remember to return your completed warranty card with all information carefully filled out.

WHEN REMOVING BLADE:

CAREFULLY REMOVE THE METAL BLADE BY GRASPING THE CENTER WHITE HUB AND LIFTING IT STRAIGHT UP. NEVER TOUCH THE BLADES, AS THEY ARE RAZOR SHARP.

TABLE OF CONTENTS

Important Safeguards	4	Removing Sliced or Shredded Foods	12
Introduction	5	Slicing and Shredding Techniques	12
Machine Includes	6	Small, Round Fruits and Vegetables . . .	12
Assembly Instructions	6	Long Fruits and Vegetables	12
Machine Functions	7	Small Amounts of Food	12
Operating Instructions	7	French-Cut Green Beans	12
Chopping, Puréeing & Mixing with Metal Blade	8	Matchsticks or Julienne Strips	12
Chop Raw Fruits and Vegetables . . .	8	Slicing Meat and Poultry	13
Purée Fruits and Cooked Vegetables . . .	8	Cooked Meat and Poultry	13
To Dislodge Food	8	Uncooked Meat and Poultry	13
Chop Hard Food	8	Slicing Sausages	13
Chop Fresh Herbs	9	Slicing and Shredding Cheese	13
Chop Peel from Citrus Fruit	9	Kneading Yeast Dough with Dough Blade	14
Chop Sticky Fruit like Dates	9	Machine Capacity	14
Chop Meat, Poultry and Fish	9	Using the Right Blade	14
Purée Meat, Poultry and Fish	9	Measuring the Flour	14
Chop Nuts	9	Proofing the Yeast	14
Make Peanut Butter	9	Processing Dry Ingredients	15
Make Flavored Butters, Spreads and Dips	9	Adding Liquids	15
Make Mayonnaise	10	Kneading Bread Dough	15
Beat Egg Whites	10	Kneading Sweet Dough	15
Whip Cream	10	Rising	15
Make Crumbs and Crumb Crusts . . .	10	Shaping, Finishing and Baking	15
Make Pastry	10	Making Consecutive Batches	15
Make Quick Breads and Cakes	10	Bread Dough Problems and Solutions	15
Preparing Food for Slicing and Shredding	11	Sweet Dough Problems and Solutions	17
Round Fruits and Vegetables	11	Cleaning and Storing	17
Whole Peppers	11	For Your Safety	18
Large Fruits like Pineapple	11	Technical Data	18
Cabbage and Iceberg Lettuce	11	Warranty	18
Packing Feed Tube for Desired Results	11	Recipes	20
Practicing Slicing and Shredding . . .	12		

Carefully read all instructions before using this appliance.

IMPORTANT SAFEGUARDS

Always follow these safety precautions when using this appliance.

Getting Ready

1. Read all instructions.
2. **Blades are sharp.**
Handle them carefully.
3. Always unplug from outlet when not in use, before putting on or taking off parts, before removing food and before cleaning. To unplug, grasp plug and pull from electrical outlet. Never pull cord.
4. Do not use outdoors.
5. Do not let cord hang over edge of table or counter, or touch hot surfaces.
6. Do not operate any appliance with damaged cord or plug, or after appliance has been dropped or damaged in any way. Return appliance to the nearest authorized service facility for examination, repair or electrical or mechanical adjustment.

Operation

1. Keep hands as well as spatulas and other utensils away from moving blades or discs while processing food, to prevent the possibility of severe personal injury or damage to food processor. A plastic scraper may be used, but only

when the food processor motor is stopped.

2. Avoid contact with moving parts. Never push food down by hand when slicing or shredding. Always use pusher.
3. Make sure motor has completely stopped before removing cover. (If machine does not stop within 4 seconds after you remove the pusher assembly, call 1-800-762-0190 for assistance. Do not use the machine.)
4. Never store any blade or disc on motor shaft. To reduce the risk of injury, no blade or disc should be placed on the shaft except when the bowl is properly locked in place and the processor is in use. Store blades and discs, as you would sharp knives, out of reach of children.
5. Be sure cover and feed tube are securely locked in place before operating food processor.
6. Never try to override or tamper with cover interlock mechanism.

Cleaning

To protect against risk of electrical shock, do not put base in water or other liquid.

General

1. Close supervision is necessary when any appliance is used by or near children.
2. Do not operate this, or any other motor-driven appliance, while under the influence of alcohol or other substances that

affect your reaction time or perception.

3. This food processor is UL listed for household use. Use it only for food preparation as described in the accompanying recipe and instruction book.
4. The use of attachments not recommended or sold by Cuisinart may cause fire, electrical shock or personal injury, or damage to your food processor.
5. To avoid possible malfunction of work bowl switch, never store processor with pusher assembly completely pushed in.
6. Maximum rating of 5.2 amperes is based on attachment that draws greatest current. Other recommended attachments may draw significantly less current.

NOTICE: This appliance has a polarized plug (one blade is wider than the other). As a safety feature, this plug will fit in a polarized outlet only one way. If the plug does not fit fully in the outlet, reverse the plug. If it still does not fit, contact a qualified electrician. Do not attempt to defeat this safety feature.

SAVE THESE INSTRUCTIONS FOR HOUSEHOLD USE ONLY

INTRODUCTION

Congratulations on your purchase of a Cuisinart® Premier™ Series 11-Cup Food Processor. This product is the ultimate food preparation tool, and it comes from the originator of the American food processor, Cuisinart.

The Cuisinart® Premier™ 11-Cup Food Processor has all the elements of quality that Cuisinart is known for, including a powerful motor, the largest feed tube, and the longest warranty in the industry.

It also introduces some new features that will set the industry standard. These are:

- **The Cuisinart® Supreme® Wide Mouth Feed Tube**, which is more than twice the size of any other available. Perfect for slicing whole fruits and vegetables.
- **The Cuisinart® Dough Control Button**. We have engineered a dough process speed along with the PowerPrep® Metal Dough Blade, which work together to give you the ability to make perfect dough in seconds.

These features, plus the ability to use all your existing Cuisinart specialty blades and discs, make the Premier™ 11-Cup the select choice in food processors.

PowerPrep® Metal Dough Blade and Hub



Chopping/Mixing Blade



4mm Slicing Disc



Medium Shredding Disc



Pusher Assembly



Cover with Cuisinart® Supreme® Wide Mouth Feed Tube

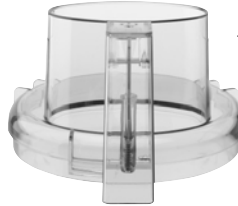

11-cup Work Bowl



Shaft (not shown)

Housing Base

Cord Wrap

THE MACHINE INCLUDES:

1. Housing base with a vertically projecting shaft and convenient touchpad control panel.
2. 11-cup work bowl.
3. Cover with extra large feed tube.
4. Pusher assembly that slides inside the feed tube.
5. Unique metal dough blade, designed specifically for our dough speed control.
6. Sharp metal chopping/mixing blade.
7. Serrated slicing disc.
8. Shredding disc.
9. Detachable stem for discs (not shown).
10. Plastic spatula (not shown).

The metal chopping blade chops raw and cooked fruits, vegetables, meat, fish and cheese to the exact consistency you want, from coarse to fine, even to a purée. It chops nuts, makes nut butters, mayonnaise and sauces, and mixes tender, flaky pastry. The metal chopping blade also mixes cakes, frostings, cookies, quick breads, muffins, and biscuits.

The PowerPrep® Metal Dough Blade is specifically designed to work in conjunction with our DOUGH control. One touch of the DOUGH button makes “perfect dough in seconds”.

The slicing disc makes beautiful whole slices

without torn edges. It slices whole fruits and vegetables, cooked meat, semi-frozen raw meat and loaves of bread.

The shredding disc processes most firm and hard cheeses into long, attractive shreds. It also shreds vegetables like potatoes, carrots and zucchini, and processes nuts and chocolate to a grated texture.

The detachable stem fits both discs, making disc storage compact in limited space.

The pusher assembly has two parts:

1. A small, removable, clear pusher that fits into a small center-located feed tube. This tube is for narrow food like carrots, for adding liquid, and for continuous feeding of small food like garlic.
2. A large pusher that fits into the Cuisinart® Supreme® feed tube opening and moves freely within it.
3. Upon contact, the large pusher meets an activating rod in the center of the work bowl handle, permitting the motor to start.

ASSEMBLY INSTRUCTIONS:

Blade Operation

1. Plug in the housing base and place the work bowl on top, with the work bowl handle just to the left of center. Turn the work bowl counterclockwise to lock it onto the housing base.

2. CAREFULLY lift and place the chosen blade over the work bowl center hub. Line up the markings on the blade hub with the motor shaft. It should fit snugly and rest on the bottom of the work bowl.
3. Add desired ingredients to work bowl.
4. Place work bowl cover onto work bowl, with the handle area just to the left of center. Turn counterclockwise to lock onto work bowl.
5. Align pusher assembly and activating rod with the feed tube opening on the work bowl cover and slide the activating rod down to the bottom.
6. You are now ready to operate the machine.

Disc Operation

1. Plug in the housing base and place the work bowl on top, with the work bowl handle just to the left of center. Turn the work bowl counterclockwise to lock it onto the housing base.
2. Choose desired disc and place with underside up on tabletop. Pick up detachable disc stem and align it with the raised plastic crescent on the disc underside. The raised ‘lock’ indicator on the left corner of the stem should be to the left of the mounting plate on disc.
3. Turn the stem to the right, so the locking tabs are covered by the metal supports and a ‘click’ locks the stem in place.
4. With the stem facing

down, place the assembly over the center hub. It should fit snugly and rest on the bottom of the work bowl.

- Place work bowl cover onto work bowl, with the handle area just to the left of center. Turn counterclockwise to lock onto work bowl.
- Align pusher with the feed tube opening on the work bowl cover and slide the activating rod down to the bottom.
- Use the cord wrap on the housing base underside to add or remove cord.
- You are now ready to operate the machine.

THE MACHINE FUNCTIONS:

PULSE

- With the machine properly assembled and engaged, and ingredients in the work bowl, press the PULSE button repeatedly as needed.

ON (Continuous)

- Properly assemble and engage the machine.
- To add ingredients through the feed tube, remove the pusher and fill the feed tube as directed (see preparing for slicing or shredding).
- Engage the pusher and press the ON button. The button light will turn on and the motor will start.
- Press the pusher firmly down until all ingredients

have passed into the work bowl. Remove the pusher and refill ingredients as needed. When you engage the pusher again, the unit and light will automatically turn ON.

- Press the OFF button when finished.

DOUGH Button

- Prepare the dough ingredients and place in work bowl.
- Properly assemble and engage the work bowl cover and pusher.
- Press the DOUGH button and the LED light will turn on.
- Then press the ON or PULSE buttons as needed to process DOUGH. The ON light will turn on.

NOTE: The dough mode works in conjunction with the ON button. The machine will not operate if only the DOUGH button is pushed. You must also push the ON button to activate the DOUGH function.

- Press the OFF button when finished.

OPERATING INSTRUCTIONS:

Try chopping some practice foods, such as zucchini or potatoes, before you process food to eat. First, cut the ingredients into 1-inch pieces of even size and length.

- Place the work bowl over the center stem and turn counterclockwise to lock in place.

- Insert the metal chopping blade and put ingredient pieces in the work bowl. Put on the cover and turn counterclockwise to lock onto work bowl. Align the pusher and the pusher's activating rod with the corresponding openings on the feed tube, and push all the way down.

- Press and release the PULSE button two or three times. Each time the blade stops, let the pieces drop to the bottom of the bowl before you pulse again. This puts them in the path of the blade each time the motor starts.

- Using the pulse/chopping technique, you get an even chop without overprocessing. Check the texture frequently by looking through the cover. If you want a finer chop, press and release the PULSE button until you achieve the desired texture. Onions and other food with a high water content will quickly end up as a purée, unless examined through the work bowl after each pulse to make sure they are not overprocessed.

Try chopping other food like meat for hamburger or sausage. Then make mayonnaise, pastry or bread, as described in the following sections. To obtain consistent results:

- Be sure all the pieces you add to the bowl are about the same size.
- Be sure the amount you process is no larger than amount recommended on the inside cover of this booklet.

- Before you do anything, wait for the blade to stop spinning. Once it does, remove the pusher assembly. Then turn the cover clockwise to unlock and remove by lifting it off.

Never try to remove the pusher, lid and work bowl together; as a safety feature, the pusher assembly must be removed before the lid and work bowl can be unlocked. They can then both be unlocked at the same time.

Remove the bowl from the base of the machine before removing the blade. This creates a seal to prevent food from leaking. Turn the bowl clockwise to unlock from the base, and lift straight up to remove.

To prevent the blade from falling from the work bowl onto your hand when emptying the work bowl, use one of the following methods.

Be sure your hands are dry. Grab the blade hub, and remove the metal blade before tilting the bowl, using a spatula to scrape off any food. Then carefully lift the blade out of the work bowl. Or insert your finger through the hole in the bottom of the work bowl, gripping the blade from the bottom, and grip the outside of the work bowl with your thumb. Or hold the blade in place with your finger or spatula while pouring out food.

TECHNIQUES FOR CHOPPING AND PURÉEING WITH THE METAL BLADE

To chop raw fruits and vegetables:

First, cut the food into 1-inch (2.5cm) pieces. You get a more even chop when all pieces are about the same size.

Put no more than the recommended amount of food into the work bowl (see table inside front cover). Lock the cover in place. Press the PULSE button at the rate of 1 second on, 1 second off, until the food is coarsely chopped. For more finely chopped results, hold the PULSE button, letting the machine run continuously until the desired consistency is reached. Check frequently to avoid overprocessing. Use the spatula to scrape down the sides of the work bowl if necessary.

To purée fruits and cooked vegetables:

First, cut the food into 1-inch (2.5cm) pieces. You get a smoother purée faster when all pieces are about equal in size.

Put no more than the recommended amount of food in the work bowl (see table inside front cover). Lock the cover in place. PULSE to chop coarsely, then press the ON button and process continuously until food is puréed. (NOTE: Cooked potatoes are an exception to this procedure. They develop a gluey texture when processed with the metal blade.)

When making soup, you will want to purée vegetables that have been cooked in liquid. Don't add the liquid to the work bowl, just the cooked vegetables; remove vegetables with a slotted spoon. They will purée faster and smoother without liquid. Then add just enough liquid to make the purée pourable. Return to the soup liquid and stir to combine.

To dislodge food:

Occasionally, a piece of food may become wedged between the blade and the work bowl. If this happens, unplug the machine, remove the cover, lift the blade out carefully and remove the wedged piece. Empty the bowl, reinsert the blade and lock the cover into place, then insert the pusher. Press the ON button and drop the food pieces through the small feed tube opening while the machine is running. After adding a cupful this way, add the remaining food to the bowl and process in the usual manner.

To chop hard foods:

To chop hard food like garlic and hard cheese, assemble the unit, remove the small pusher, press the ON button and drop the food through the small feed tube while the machine is running.

Small foods like garlic can be dropped in whole. Large foods like hard cheese should be cut into 1-inch (2.5cm) pieces. This method of processing minces garlic, shallots and onions. Hard cheese and coconut will

have the same texture as if they had been hand grated.

IMPORTANT: Never try to process cheese that is too hard to cut with a knife. You may damage the blade or the machine.

To chop parsley and other fresh herbs:

The herbs, the work bowl and the metal chopping blade must all be thoroughly clean and dry. Remove stems from herbs. Add leaves to bowl and process, using the PULSE button, until chopped as fine as desired. The more herbs you chop at a time, the finer chop you can obtain. If completely dry when chopped, parsley and other herbs will keep for at least 4-5 days, stored in an airtight bag in the refrigerator. They may be frozen for months, stored in an airtight container or bag.

To chop peel from citrus fruit or to chop sticky fruit like dates or raisins:

For citrus, remove only the peel with a vegetable peeler, not the white pith which is bitter tasting.

Cut the peel into lengths of 2 inches (5cm) or less and process with 1/2 cup (125 ml) of granulated sugar until finely chopped. This may take 2 minutes or longer.

For sticky fruit like dates, raisins, prunes and candied fruit, first freeze the fruit for about 10 minutes. Add some of the flour called for in the recipe to the fruit. Use no more than 1 cup (250 ml) of flour for each cup of fruit.

9

To chop meat, poultry, fish and seafood:

The food should be very cold, but not frozen. Cut it into 1-inch (2.5cm) pieces to ensure an even chop. Using the ON button, process no more than the recommended amount at one time (see table inside front cover). Press the PULSE button 3 or 4 times at a rate of 1 second on, 1 second off. If the food is not chopped fine enough, let the processor run continuously for a few seconds. Check the texture often to avoid overprocessing. Use a spatula to scrape food from the sides of the bowl as necessary.

To purée meat, poultry, fish and seafood:

Prepare the food as described above. Press the PULSE button until evenly chopped, then process continuously to the desired texture. Scrape the bowl with a spatula as needed.

Leave the purée in the work bowl and add eggs, cream and seasonings as called for by the recipe. Process to combine thoroughly.

Remember, you control texture by the length of time you process. By varying the processing time, you can get a range of textures suitable for hamburgers, hash, stuffed peppers, or smooth mousses.

To chop nuts:

Chop no more than the recommended amount at one time. Press and release the PULSE button and check frequently to

avoid nuts clumping together in a nut butter. When a recipe calls for flour or sugar, add some to the nuts before you chop, about 1/2 cup for each cup of nuts. This allows you to chop the nuts as fine as you want without turning them into a nut butter. You can also chop nuts with a shredding disc. The optional Fine Shredding Disc is particularly good.

To make peanut butter and other nut butters:

Process up to the recommended amount of nuts. Using the ON button, let the machine run continuously. After 2 or 3 minutes, the ground nuts will form a ball that will gradually smooth out. Scrape the sides of the bowl and continue processing until drops of oil are visible. Taste for consistency. The longer you process, the softer the butter. For chunk style, add a handful of nuts just after the ball of nut butter begins to smooth out. To make cashew butter, add a little bland vegetable oil. Processor nut butters contain no preservatives. Store in refrigerator to keep from separating.

To make flavored butters, spreads and dips:

Cut room temperature butter into tablespoon size pieces. Finely chop flavoring ingredients first, such as anchovies, cheese, herbs, etc. Be sure work bowl is clean and dry. Add small hard ingredients like garlic and hard cheese through the feed tube while machine is running. Next, add the butter and process using the ON button, until

smooth. Add any liquid ingredients last, while the processor is running, and process just long enough to blend. Process ingredients for spreads and dips the same way. They should be at room temperature and cut into 1-inch (2.5cm) cubes, or added by tablespoonfuls.

To make mayonnaise:

You can make foolproof homemade mayonnaise with your Premier™ Food Processor. The work bowl and metal blade must be clean and dry. Use the metal blade to process eggs (for safe food procedures, we recommend using pasteurized liquid eggs, or the "cooked egg" recipe on page 52), salt, vinegar or lemon juice, dry mustard, and two tablespoons of the oil until smooth, at least 30 seconds. With the machine running, pour 1/4 cup of the oil into the small pusher. After it dribbles through the pinhole in the bottom, remove the small pusher and very slowly add the remaining oil while the machine runs. Process until all the oil has been added and the mixture is totally emulsified. Remove from the processor, cover and keep chilled until ready to use. Homemade mayonnaise will keep in the refrigerator for 3 to 4 days.

For a "one egg" batch of basic mayonnaise, use 1/4 cup of liquid pasteurized eggs, 2 tablespoons vinegar or lemon juice, 1 teaspoon dry mustard, 1/2 teaspoon kosher salt and 1 cup vegetable oil, such as canola oil. For variation, you may experiment with using flavored vinegars, or

adding chopped fresh herbs, or even roasted garlic to taste. To make your mayonnaise a little lighter, you may add some well-drained nonfat plain yogurt to taste.

To beat egg whites:

The work bowl must be absolutely clean. Add 3 or more egg whites (up to 6 large egg whites) and press the ON button. Add about 1 teaspoon of lemon juice or vinegar for every egg white. Vinegar makes stiffer whites; its flavor is hardly detectable in cakes or soufflés. Continue processing until the egg whites hold their shape, about 1-1/2 to 2-1/2 minutes.

To whip cream:

Processor whipped cream holds its shape very well. It is good for decoration or as a topping; however, it will not whip to the light, fluffy consistency obtained by methods that beat in more air. Chill the cream well before starting. Process continuously using the ON button, until cream begins to thicken. Then add sugar as desired and continue processing, watching carefully for the desired consistency. For consistently reliable results, add 2 tablespoons (30 ml) of nonfat dry milk for every cup of cream before whipping.

To make crumbs and crumb crusts:

Cut or break bread, crackers or cookies into 1-inch pieces and place in work bowl. Press the ON button and process continuously until crumbs reach the desired texture.

For seasoned crumbs, chop parsley or other fresh herbs with the crumbs. For buttered crumbs, process until the dry crumbs are of the desired texture, then dribble melted butter through the small feed tube opening while the machine is running. For crumb crusts, process crackers or cookies as described above. Add sugar, spices and butter, and cut into pieces as specified by your recipe. Process until well combined.

To make pastry:

Combine unbleached all-purpose flour, salt and pieces of very cold butter in the work bowl. Process to the consistency of cornmeal. Sprinkle evenly with the minimum amount of cold liquid in the recipe. PULSE 5 or 6 times. The dough should begin to hold together when pressed. If it is still dry and crumbly, add more water – 1 teaspoon at a time – until the dough holds together easily. Do not let the dough form a ball in the processor or it will be overworked and tough. Form into a round disc, one inch thick, and wrap in plastic wrap. Refrigerate for 1 hour before using, or double wrap and freeze for later use.

To make quick breads and cakes that use baking powder and/or soda:

The most important rule for success is not to overmix after adding the flour. The ingredients for these soft doughs should be cold. If the recipe calls for chopped ingredients like lemon peel or nuts,

chop them first while the work bowl is clean and dry, then set aside until needed.

Put dry ingredients like flour, salt and leavening in the work bowl and process with the metal blade for 5 seconds to mix. Remove and reserve the dry ingredients.

Add the eggs and sugar to the work bowl and, using the ON button, process to mix, letting the machine run about 1 minute. Next, add butter at room temperature and cut into 1-inch pieces. Run machine continuously for a minute, until the butter is thoroughly mixed with the sugar and eggs. Then add flavoring and liquid – vanilla, spices, cocoa, etc. Process until mixed. Add the dry ingredients to the work bowl.

Process by pulsing, inspecting after each pulse. Stop pulsing as soon as the dry ingredients have almost disappeared into the batter. Overprocessing will cause quick breads and cakes to be tough. (If your recipe calls for ingredients that are to be coarsely chopped – like raisins or nuts – add them last with the mixed dry ingredients.)

To make cake mix:

Your food processor work bowl is large enough for the preparation of an 18.5-ounce packaged cake mix.

Insert the metal blade and add the cake mix to the work bowl. Press the ON button and while the machine is running, add the eggs and liquid through the small feed tube and process for 5 seconds.

11

Scrape down the sides of the work bowl and process 1 minute more for maximum volume. Do not remove the metal blade.

Insert a finger into the underside of the blade from the bottom of the work bowl, to hold the blade in place while emptying the batter.

Tip:

After emptying cake batter or puréed soup from the work bowl, replace the bowl on the motor base and PULSE once. Centrifugal force will spin the batter off the blade onto the sides of the work bowl. Remove the blade, and use the spatula to scrape any remaining batter from the bowl.

PREPARING FOOD FOR SLICING AND SHREDDING

For disc assembly instructions, refer to Assembly Instructions.

Round fruits and vegetables:

Before processing onions, apples and other large, round fruits and vegetables, cut the bottom ends flat to make the food lie stable on the disc.

Place the food in the feed tube, flat side down, as far left as possible, to prevent it from tilting when being processed.

Choose fruits that are firm and not too ripe. Remove large hard pits and seeds from fruits before processing. Seeds from citrus fruits need not be removed. Remove the rind before slicing or shredding, if desired.

Whole peppers are an exception:

Remove the stem and cut the stem end flat. Remove the core and scoop out the seeds. Leave the end opposite the stem whole, to keep the structure stiff. This ensures round, even slices.

Large fruits like pineapple:

Cut the ends flat, cut in half, and either core or remove the seeds. If necessary, cut the halves into smaller pieces to fit the feed tube.

Cabbage and iceberg lettuce:

Turn the head on its side and slice off the top and bottom, leaving a center section about 3 inches (8cm) deep. Remove the core, then cut in wedges to fit the feed tube. Remove the core from the bottom and top pieces and cut into wedges to fit into the feed tube.

The optional 2mm and 1mm Slicing Discs are excellent for slicing cabbage for coleslaw.

If the fruit or vegetable doesn't fit, try inserting it from the bottom of the feed tube, where the opening is slightly larger.

Pack the feed tube for desired results:

For long slices or shreds, cut the food in feed tube widths and pack the pieces horizontally.

For small, round slices or short shreds from carrots, zucchini and other long vegetables, cut in feed tube heights and pack tightly upright.

Food should fit snugly, but

not so tightly that it prevents the pusher from moving.

When slicing or shredding, always use the pusher.

Never put your fingers or a spatula into the feed tube.

Never push down hard on the pusher. Use light pressure for soft fruits and vegetables like bananas, mushrooms, strawberries and tomatoes, and for all cheeses. Use medium pressure for most food: apples, celery, citrus fruit, potatoes and zucchini. Use firm pressure for hard vegetables like carrots and yams.

PRACTICING SLICING AND SHREDDING

1. Insert a slicing or shredding disc, put the cover on the work bowl and insert the food in the feed tube.
2. Slide the pusher into place, and apply pressure to the pusher while pressing down the PULSE button. Release the button as soon as the food is sliced or shredded.
3. You can load the feed tube repeatedly without removing work bowl cover. Simply grasp the pusher and lift up. The pusher assembly will come off easily, leaving the cover and feed tube in place. Your other hand is free to reload the feed tube, and you do not need to re-press the ON button if it was previously selected.

REMOVING SLICED OR SHREDDED FOOD

Before you do anything, wait for the disc to stop spinning. When it does, remove the pusher first. Unplug the unit, then hold the work bowl handle and turn it clockwise. Then lift; the work bowl and cover will come off together. Turn cover clockwise to unlock from work bowl. Lift, remove, invert and place on counter space.

Remove the slicing or shredding disc:

Place two fingers under each side of the disc and lift it straight up. Place the disc on top of the inverted work bowl cover to minimize drips and spills.

TECHNIQUES FOR SLICING AND SHREDDING

Small, round fruits and vegetables:

For large berries, radishes and mushrooms, trim the bottom ends flat with a knife. Insert the food through the feed tube, standing each piece on a flat end. You can fill the tube to about 1 inch (2.5cm) from the top. The bottom layer gives you perfect slices for garnish. If you want all the slices to be perfect, it's best to process one layer at a time.

Long fruits and vegetables:

Trim foods like bananas, celery and zucchini by cutting them into pieces slightly shorter than the

feed tube. Cut both ends flat. (Use a ruler as a guide, or the pusher assembly.)

Fill the feed tube with the pieces, standing them vertically and adding enough pieces so they are solidly packed and cannot tilt sideways as they are sliced or shredded.

Small amounts of food:

Use the small feed tube and the small pusher. Remove the small pusher from the pusher assembly. Place the pusher assembly onto the feed tube and press the sleeve all the way down.

Cut the food in lengths slightly shorter than the feed tube. If slicing one or two long, thin vegetables like carrots, push them to the far left. If you are slicing a few vegetables that are wide at one end and narrow at the other (carrots, celery or scallions), cut them in half and pack in pairs, alternating one wide end up, one narrow end up.

French-cut green beans:

Trim fresh green beans to feed tube widths. Stack in the feed tube horizontally to about one inch from the top. Use the slicing disc, apply light pressure to the pusher and press the PULSE button until beans are sliced.

To make long, horizontal slices of raw zucchini or carrots, use the same procedure.

Matchsticks or julienne strips:

Process the food twice – 'double slice' it. Insert large fruits or vegetables

(potatoes, turnips, zucchini, apples) in the feed tube horizontally. Apply pressure to the pusher while pressing the PULSE button until the food is sliced. You will get long slices.

Remove the slices from the work bowl and reassemble. Reinsert them in the feed tube, wedging them in tightly. Slice them again. You will obtain long julienne strips. With the optional Square Julienne Disc, you can make square julienne strips in one operation.

SLICING MEAT AND POULTRY

Cooked meat and poultry:

The food must be very cold. If possible, use a piece of food just large enough to fit in the feed tube. To make julienne strips of ham, bologna or

luncheon meat, stack slices, then roll or fold them double and stand upright in the feed tube, wedging in as many rolls as possible. This technique works better with square or rectangular pieces than with round ones.

Uncooked meat and poultry:

Cut the food into pieces to fit the feed tube. Boneless, skinned chicken breasts will usually fit when cut in half crosswise. Wrap the pieces in plastic wrap and put them in the freezer. They are ready to slice when they are easily pierced with the tip of a sharp knife, although semi-frozen and hard to the touch. Remove plastic wrap. Stand them in the feed tube, cut side down, and slice them against the grain, using firm pressure

on the pusher. Or lay them flat in the feed tube, as many as will fit, and slice with the grain, using firm pressure.

Salami and other sausages:

If the sausage is soft, freeze it until hard to the touch but easily pierced with the tip of a sharp knife. Hard sausages need not be frozen. Use the small feed tube if the sausage is thin enough to fit. Otherwise, cut the sausage into pieces to fill the large feed tube completely. Stand the pieces vertically, packing them tightly so they cannot tilt sideways.

Firm cheese like Swiss and Cheddar:

Cut the cheese into pieces to fit the feed tube. Put it in the freezer until semi-frozen, hard to the

SLICING AND SHREDDING CHEESE

TYPE OF CHEESE	CHOP/ PURÉE	SHRED	SLICE
Soft			
Brie, Camembert, room temperature	yes	no	no
Mozzarella, chilled 15-20 min in freezer	no	yes	no
Ricotta, room temperature	yes	no	no
Cottage, Cream	yes	no	no
Semi-Soft			
Blue, chilled	yes	yes	no
Fontina, chilled	yes	yes	no
Bel Paese, chilled	yes	yes	no
Semi-Hard			
Cheddar, chilled	yes	yes	yes
Monterey Jack, Longhorn, chilled	yes	yes	yes
Swiss, Jarlsberg, chilled	yes	yes	yes
Edam, Gouda, chilled	yes	yes	yes
Provolone, chilled	yes	yes	yes
Hard, at room temperature			
Parmesan, Romano, Locatelli	yes	yes	no
Pecorino, Asiago	yes	yes	no

*Soft and semi-soft cheeses will purée; semi-hard and hard cheeses will chop.

touch but easily pierced with the tip of a sharp knife. Stand the pieces in the feed tube and apply light pressure to the pusher.

IMPORTANT:

Never try to slice soft cheese like mozzarella or hard cheese like Parmesan. You may damage the slicing disc or the food processor itself. You can successfully shred most cheeses except soft ones. The exception is mozzarella, which shreds well if thoroughly chilled. Hard cheeses like Parmesan shred well only at room temperature. Therefore, only attempt to shred mozzarella when well chilled, and Parmesan when at room temperature.

TECHNIQUES FOR KNEADING YEAST DOUGH WITH THE POWERPREP® METAL DOUGH BLADE

The Premier™ 11-Cup Food Processor is designed to mix and knead dough in a fraction of the time it takes to do it by hand. You will get perfect results every time if you follow these directions.

NEVER TRY TO PROCESS DOUGH THAT IS TOO STIFF TO KNEAD COMFORTABLY BY HAND.

There are two general types of yeast dough.

Typical bread dough is made with a flour mix that contains at least 50% white

flour. It is uniformly soft, pliable and slightly sticky when properly kneaded. It always cleans the inside of the work bowl completely when properly kneaded.

Typical sweet dough contains a higher proportion of sugar, butter and/or eggs than typical bread dough. It is rich and sticky and it does not clean the inside of the work bowl. It requires less kneading after the ingredients are mixed. Although 30 seconds are usually sufficient, 60 to 90 seconds give better results if the machine does not slow down. Except for kneading, described below, the processing procedures and use of the DOUGH button are the same for both types of dough.

Machine capacity:

Recommended maximum amount of flour is 5 cups of all-purpose flour or 2-3/4 cups of whole-grain flour. If a bread dough calls for more than the recommended amounts of flour, mix and knead it in equal batches. Do the same for sweet doughs that call for more than 3-1/2 cups of flour.

Using the right blade:

Use the metal dough blade when the recipe calls for more than 3-1/2 cups (17-1/2 ounces) (875 ml) of flour. Use the metal chopping blade when a recipe calls for less than 3-1/2 (875 ml) cups of flour.

Because the metal dough blade does not extend to the outside rim of the work bowl, it cannot pick up all the flour when small amounts are processed.

Measuring the flour:

It's best to weigh it. If you don't have a scale, or the recipe does not specify weight, measure by the stir, scoop and sweep method. Use a standard, graduated dry measure, not a liquid measuring cup.

With a spoon or fork, stir the flour in its container. Do not measure flour directly out of the bag; it is too packed to get an accurate measure. With the dry measure, scoop up the flour so it overflows. With a spatula or knife, sweep excess flour back into the container so the top of the measure is level. Do not pack flour into the dry measure.

Proofing the yeast:

The expiration date is marked on the package. To be sure your yeast is active, dissolve it in a small amount of warm liquid (about 1/3 cup [75 ml] for one package of dry yeast). The temperature of liquid used to dissolve and activate yeast must be between 105° and 115°F (40°C and 46°C). Yeast cells are not activated at temperatures lower than this and they die when exposed to temperatures higher than 130°F (54°C). If the recipe includes a sweetener like sugar or honey, add a teaspoon with the yeast. If no sweetener is called for, add a pinch, or add a pinch of flour. The yeast won't foam without it. Let the mixture stand until it foams, up to 10 minutes.

Processing dry ingredients:

Put the flour in the work bowl with all the other dry ingredients. If the recipe calls for herbs, oil or solid fats like butter, add them with the flour. Turn the machine on and let it run for about 20 seconds. (Cheese, nuts and raisins may be added with the dry ingredients or during the final kneading. To leave them almost whole, add them 5 seconds before you stop kneading. For a finer texture, add them sooner.)

Adding liquids:

All liquid should be added through the feed tube while the machine is running. Add liquid in a slow, steady stream, only as fast as dry ingredients absorb it. If liquid sloshes or splatters, stop adding it but do not turn off the machine. Wait until ingredients in bowl have mixed, then add remaining liquid slowly. Pour liquid onto dough as it passes under feed tube opening. Do not pour liquid directly onto bottom of bowl.

Follow the recipe carefully. It is important to add enough liquid to make the dough soft enough to knead. Kneading dough that is too stiff can strain the machine.

All liquid, except that which is used to activate yeast, should be cold, to minimize the possibility of overheating the dough. You must never knead a yeast dough to a temperature higher than 100°F (37°C). Doing so will slow or even prevent the action of the yeast.

Kneading bread dough:

Do not try to use the machine to knead dough that is too stiff to knead comfortably by hand. Doing so can strain the machine.

After the dough starts to clean the inside of the work bowl completely and forms a ball, process it for 60 seconds to knead it. Stop the machine and test the dough to be sure it's properly kneaded. Typical bread dough should have a soft, pliable texture and it should feel slightly sticky. Stretch the dough with your hands to test it. If it feels hard, lumpy or uneven, continue processing until it feels uniformly soft and pliable. Make sure that the blade is firmly pressed back into place after removing the dough to test it.

Kneading sweet dough:

Process dough for at least 30 seconds after all the ingredients have been incorporated. It will not clean the inside of the work bowl. If necessary, scrape the bowl and process for 5 more seconds.

Rising:

Put the dough in a large, lightly floured resealable plastic bag. Squeeze out all the air and close tightly, allowing space for the dough to rise.

Or put the ball of dough in a large bowl coated with soft butter or vegetable oil. Roll the dough around to coat its entire surface. Cover it with a damp towel or a piece of oiled plastic wrap.

Let it rise in a warm, draft-free place, about 80°F

(26°C). The rising time is usually about 1-1/2 hours but will vary from 45 minutes to several hours, depending on the type of flour and the humidity of the air. To test if the dough has risen enough, stick a finger in it. An indentation should remain. If it doesn't, let the dough rise more and test again.

When it has risen enough, punch the dough down.

Shaping, finishing and baking:

If you shape the dough in loaf pans, fill pans only half full. Let rise until dough is just slightly above the top of the pan. If shaping free-form loaves, let them rise on an oiled baking sheet until at least doubled in bulk.

Making consecutive batches:

You can make several batches of bread dough in a row. The motor in the Premier™ 11-Cup Food Processor is extremely efficient.

TYPICAL BREAD DOUGH PROBLEMS AND SOLUTIONS

If dough blade doesn't incorporate ingredients:

Always start processor before adding liquid. Add liquid in slow, steady stream, only as fast as dry ingredients absorb it. If you hear liquid sloshing, stop adding it but do not turn off machine. Instead, wait until ingredients in work bowl have mixed, then add

remaining liquid slowly. Pour liquid onto dough as it passes under feed tube; do not pour liquid directly onto bottom of work bowl.

Blade rises in work bowl:

Blade may not have been pushed down as far as possible before processing started.

Excessively sticky dough can cause blade to rise even though it cleans inside of work bowl. If dough feels very sticky, reinsert blade and immediately add 2 tablespoons (30 ml) flour through feed tube while machine is running.

Dough doesn't clean inside of work bowl:

- Amount of dough may exceed maximum capacity of your food processor. Remove half and process in 2 batches.
- Dough may be too dry. If it feels crumbly, add water, 1 tablespoon (15 ml) at a time, while machine is running, until dough becomes moist and cleans inside of work bowl. Wait 10 seconds between additions of water.
- Dough may be too wet. While machine is running, add 1 tablespoon (9 gm) of flour. If necessary, add more, 1 tablespoon (9 gm) at a time, until dough cleans inside of work bowl and forms a ball.

The PowerPrep® Metal Dough Blade is intended only for recipes calling for at least 3 cups of flour (15 ounces) (496 gm). If your recipe calls for less flour,

remove metal dough blade and insert metal chopping blade. Always use metal chopping blade for smaller recipes calling for less than 3 cups (496 gm) of flour.

Nub of dough forms on top of blade and does not become uniformly kneaded:

Stop machine, carefully remove dough, divide into 3 pieces and redistribute evenly in work bowl. Continue processing until dough is uniformly soft and pliable.

Dough feels tough after kneading:

Divide dough into 2 or 3 pieces and redistribute evenly in bowl. Process 10 seconds or until uniformly soft and pliable.

Soft dough or liquid leaks onto base of food processor:

Always start processor before adding liquid and add liquid only as fast as dry ingredients absorb it.

Motor stops:

- Cover may have become unlocked.
- Power cord may have become unplugged.
- Excessive strain may have caused motor to overheat and stop. Wait for the motor to cool, 5-10 minutes. A safety protector in the motor prevents excessive overheating. If the motor stops, turn machine off. After 5-10 minutes, divide dough into 2 batches and complete processing. Pinch dough to make sure that it is not

too stiff to knead comfortably by hand. If it is, add liquid, 1 teaspoon (5 ml) at a time, until dough is sufficiently moist to clean inside of bowl.

Dough doesn't rise:

We recommend you always test activity of yeast before using, by stirring it and at least 1/2 teaspoon (2 ml) sugar into about 1/3 cup (75 ml) warm liquid (105° - 120°F) (40°C - 48°C). Within 10 minutes foam should develop, indicating yeast is active. Do not use dry yeast after expiration date on package.

Do not use warmer water, or overheat dough with excessive kneading, as it may kill the yeast cells. All other liquid should be cold.

Don't knead so long that dough becomes overheated. The ideal temperature for kneaded dough is 80°F (26°C); it should never exceed 100°F (37°C).

Let dough rise in draft-free environment of about 80°-90°F (26°C-32°C).

Dough containing whole grain flour will take longer to rise than dough made of white flour only.

Baked bread is too heavy:

Next time, feel dough to be sure it is uniformly soft, pliable and slightly sticky before setting aside to rise. Let dough fully double in bulk in bowl or bag, then punch it down, and let it double again after it is shaped.

TYPICAL SWEET DOUGH PROBLEMS AND SOLUTIONS

Motor slows down:

- Amount of dough may exceed maximum capacity. Remove half, and process in 2 batches.
- Don't process too long after all ingredients are incorporated. Rich doughs will give you good results after only 30 seconds of kneading.

Blade doesn't incorporate ingredients:

Butter or margarine, if not melted, must be cut into tablespoon-size pieces before being added to work bowl. Make sure butter or margarine is at room temperature.

Metal dough blade rises in work bowl:

Blade may not have been pushed down as far as possible before processing started. Machine may be overloaded. Remove half of dough and process in 2 batches.

Motor stops:

See comments under 'Typical Bread Dough Problems and Solutions'.

Dough doesn't rise:

See comments under 'Typical Bread Dough Problems and Solutions'.

CLEANING AND STORAGE

Keep your food processor ready to use on a kitchen
17

counter. When not in use, leave it unplugged. Don't leave it with the pusher assembly in the locked position; this could damage the interlock mechanism.

Store the blades and discs as you would sharp knives, out of the reach of children. The disc and blade holders are optional accessories which offer safe and convenient storage.

All parts except the housing base are dishwasher safe, and we recommend washing them in the dishwasher on the **top rack only**.

Due to intense water heat, washing the work bowl and work bowl cover on the bottom rack of your dishwasher may cause damage over time. Insert the work bowl upside down. Remember to unload the dishwasher carefully wherever you place sharp blades and discs.

To simplify cleaning, rinse the work bowl, cover, pusher assembly and blade or disc immediately after use, so food won't dry on them. Openings at the bottom of the large pusher provide drainage and make cleaning easy. If food lodges in the pusher, remove it by running water through it, or use a bottle brush.

If you wash blades and discs by hand, do it carefully. Avoid leaving them in soapy water where they may disappear from sight. To clean the metal blade, fill the work bowl with soapy water, hold the blade by its plastic center and move it rapidly up and down on the center shaft of the bowl. Use of a spray attachment is also effective. If necessary, use a brush.

The work bowl is made of Lexan® (plastic), which is shatter resistant and heat resistant. It should not be placed in a microwave oven, as the aperture at the front of the pusher houses the metal rod that activates the motor.

TIP:

When preparing a meal, make the dishes with the least amount of wet ingredients first. For example, make the bread first; then you don't need to wash the bowl before making the salad. In many cases, wiping the bowl with a paper towel between recipes is sufficient.

Chopping certain foods may scratch or cloud the work bowl. These foods include ice, whole spices, coffee beans and oils like wintergreen. If you like to prepare your own spice blends, you may want to keep a second bowl just for that purpose.

The housing base is made of a tough plastic with high impact resistance. Its smooth surface will look new for years. Keep a sponge handy as you work, and wipe spills from the base.

Four rubber feet on the underside keep the base from moving on most work surfaces when the machine is processing heavy loads. If the feet leave spots on the counter, spray them with a spot remover and wipe with a damp sponge. If any trace of the spot remains, repeat the procedure and wipe the area with a damp sponge and nonabrasive cleaning powder. Dry completely.

To clean the inside of the detachable stem, slide the stem release button on the side up as far as it will go and hold it there as you run water through the stem.

IMPORTANT:

Never store any blade or disc on the motor shaft. No blade or disc should be placed on the shaft except when the processor is about to be used.

FOR YOUR SAFETY

Like all powerful electrical appliances, a Premier™ Series Food Processor should be handled with care. Follow these guidelines to protect yourself and your family from misuse that could cause injury.

Handle and store metal blades and discs carefully. Their cutting edges are very sharp.

Always place discs on flat, stable surface before connecting detachable stem.

Never put blades or discs on the motor shaft until the work bowl is locked in place.

Always be sure that the blade or disc is down on motor shaft as far as it will go.

Always insert chopping blade and dough blade in the work bowl before putting ingredients in bowl.

When slicing or shredding food, always use the pusher. Never put your fingers or spatula into feed tube.

Always wait for the blade or disc to stop spinning before you remove the pusher assembly or cover from

the work bowl.

Always unplug the unit before removing food, cleaning, or putting on or taking off parts.

Always remove work bowl from base of machine before you remove chopping blade or dough blade.

Be careful to prevent the chopping blade from falling out of the work bowl when emptying the bowl. Remove blade before tilting bowl, or hold it in place with your finger, a spatula or a spoon.

TECHNICAL DATA

The motor in your food processor operates on standard line operating current. The appropriate voltage and frequency for your machine are shown on a label under the base.

An automatic, temperature-controlled circuit breaker in the motor ensures complete protection against motor burnout. If the processor runs for an exceptionally long time when chopping, mixing or kneading a thick or heavy mixture in successive batches, the motor may overheat. If this happens, the processor will stop. Turn it off and wait for the motor to cool before proceeding. It will usually cool within 10 minutes. In extreme cases, it could take an hour.

Safety switches prevent the machine from operating when the work bowl or the cover is not locked into position. The motor stops within seconds when the motor is turned off, and a fast-stop circuit stops it

instantly when the pusher assembly is removed.

Cuisinart® Premier™ Series offers a Three Year Limited Warranty on the Entire Machine.

FULL TEN YEAR WARRANTY ON MOTOR

This warranty supersedes all previous warranties on Cuisinart® Premier™ Series Food Processors.

This warranty is available to consumers only. You are a consumer if you are the owner of a Cuisinart® Premier™ Series Food Processor that was purchased at retail for personal, family or household use. This warranty is not available to retailers or other commercial purchasers or owners.

We warrant that your Cuisinart® Premier™ Series Food Processor will be free of defects in material or workmanship under normal home use for three years from the date of original purchase.

We warrant that the motor for your Cuisinart® Premier™ Series Food Processor will be free of defects in material or workmanship under normal home use for ten years from the date of original purchase. This motor warranty covers the motor and excludes all other parts in the motor base assembly area such as the upper and lower plastic housings, work bowl and cover, blades and all electrical components and vertical projecting motor shaft sheath.

We suggest you complete and return the enclosed warranty registration card promptly to facilitate verification of original purchase date. However, return of the warranty registration card is not a condition of this warranty and does not eliminate the need for the consumer to maintain the original proof of purchase. In the event that you do not have proof of purchase date, the purchase date for purposes of this warranty will be the date of manufacture.

If your Cuisinart® Premier™ Series Food Processor should prove to be defective within the warranty period, we will repair it, or if we think necessary, replace it, without charge to you. To obtain warranty service, simply call our toll-free number 800-726-0190 for additional information from our Customer Service Representatives or send the defective product to Customer Service at Cuisinart, 150 Milford Rd. East Windsor, NJ 08520.

CALIFORNIA RESIDENTS ONLY:

California law provides that for In-Warranty Service, California residents have the option of returning a nonconforming product (A) to the store where it was purchased or (B) to another retail store which sells Cuisinart products of the same type. The retail store shall then, at its discretion, either repair the product, refer the consumer to an independent repair facility, replace the product, or

refund the purchase price less the amount directly attributable to the consumer's prior usage of the product. If either of the above two options does not result in the appropriate relief to the consumer, the consumer may then take the product to an independent repair facility if service or repair can be economically accomplished. Cuisinart and not the consumer will be responsible for the reasonable cost of such service, repair, replacement, or refund for nonconforming products under warranty.

California residents may also, according to their preference, return nonconforming products directly to Cuisinart for repair, or if necessary, replacement, by calling our Consumer Service Center toll-free at 800-726-0190. Cuisinart will be responsible for the cost of the repair, replacement, and shipping and handling for such products under warranty.

If the problem with the machine is determined to be a defect of the motor, and within the warranty period, all postage and handling charges will be refunded.

Please be sure to include your return address, daytime phone number, description of the product defect, product serial number, original date of purchase, and any other information pertinent to the product's return.

Your Cuisinart® Premier™ Series Food Processor has been manufactured to the strictest specifications

and has been designed for use with the authorized accessories and replacement parts.

This warranty expressly excludes any defects or damages caused by accessories, replacement parts, or repair service other than those that have been authorized by Cuisinart.

This warranty excludes all incidental or consequential damages.









Warning:

Our Premier™ Series Food Processor, and other Cuisinart® Food Processors and Accessories have been carefully designed and manufactured with the highest quality materials to assure your satisfaction and safety when you use them. Although accessories sold by companies other than Cuisinart may be compatible with your Cuisinart machine, they may also be extremely dangerous, and expose the user to serious injury.

We specifically caution you not to use other brand accessories, such as juicers, which permit your machine to operate with exposed cutting or shredding discs. We also caution you not to use the large feed tube on this machine with machines built by other manufacturers.

If you have any questions about the safety features of the Cuisinart® Premier™ Series Food Processor or any other Cuisinart® product, please call us at the toll-free number above.

Recipe Table of Contents

 Appetizers	21
 Soups	26
 Breads	29
 Entrées	42
 Pizzas	45
 Sauces and Dressings	49
 Sides	54
 Desserts	58



Appetizers

Fresh Tomato and Corn Salsa

Try this salsa on grilled chicken or seafood.

Makes 2 cups

Preparation: 5 - 10 minutes, plus 1 hour resting time

- | | | | |
|-----|--|-------|--|
| 1 | small onion, peeled, cut into 1-inch pieces (about 1 cup pieces) | 1-1/2 | teaspoons fresh lime juice |
| 1/3 | cup fresh cilantro | 2/3 | cup fresh or frozen corn kernels (frozen kernels do not need to be thawed) |
| 1 | medium jalapeño pepper, seeded, cut into 1-inch pieces | 3/4 | teaspoon kosher salt |
| 3 | medium vine-ripened tomatoes, cut into 1-inch pieces | | |

Insert the metal blade. Place onion, cilantro and jalapeño in work bowl. Process until finely chopped, about 5 seconds. Scrape work bowl. Add tomatoes and lime juice. Pulse until tomatoes are coarsely chopped, about 5 to 7 times. Add corn and salt; pulse once to just combine. Let sit for 1 hour before serving to allow flavors to develop. Serve with chips.

Nutritional analysis per tablespoon:

Calories 8 (0% from fat) • carbo. 2g • pro. 0g • fat 0g
sat. fat 0g • chol 0mg • sod. 56mg • fiber 0g

Roasted Garlic and Red Pepper Spread

There is no such thing as too much garlic when it is roasted.

Makes 1-3/4 cups

Preparation: 5 - 10 minutes, plus 1 hour to roast the garlic and 1 hour resting time.

- | | | | |
|-------|--|-----|--|
| 1-1/2 | large heads of garlic (entire bulb), cloves peeled | 1 | medium scallion, trimmed, cut into 1-inch pieces |
| 1 | teaspoon extra virgin olive oil | 1/3 | cup roasted red peppers (from a jar) |
| 1-1/3 | cups lowfat sour cream | 1/8 | teaspoon freshly ground black pepper |

Preheat oven to 375°F. Toss the peeled garlic cloves in the olive oil and wrap in foil. Set on middle oven rack and roast for 1 hour. Remove from oven and cool.

Insert the metal blade. Purée the cooled garlic, 20 seconds. Scrape work bowl. Add remaining ingredients and process for 10 - 15 seconds. Scrape work bowl and process until smooth, about 10 seconds longer. Let sit in refrigerator to develop flavor, about 1 hour. Serve with crudités or breadsticks.

Nutritional analysis per tablespoon:

Calories 30 (60% from fat) • carbo. 2mg • pro. 1g • fat 2g
sat. fat 1g • chol. 5mg • sod. 12mg • fiber 0g

Hummus

This popular Middle Eastern sauce may be served with the traditional pita wedges or may be used as a dip for fresh vegetable crudités.

Preparation: 10 – 15 minutes (plus 1 hour roasting time for shallots or garlic if using), plus 30 minutes resting time

Makes 2-3/4 cups / 44 tablespoons

1/3	cup fresh flat parsley leaves, washed and dried	1/4	cup tahini paste
2	strips lemon zest, 2 x 1/2 inches, bitter white pith removed	3	tablespoons freshly squeezed lemon juice
3/4	teaspoon kosher salt	1/4	cup water
2	large cloves garlic	2-1/4	teaspoons ground cumin
2	15.5 ounce cans chickpeas (garbanzos), drained, rinsed and drained again	2	tablespoons extra virgin olive oil

Insert the metal blade. Pulse to chop the parsley, 10 to 15 times. Remove and reserve. Pulse to chop the lemon zest with the kosher salt, 10 to 15 times. With the machine running, drop the garlic down the feed tube; process 10 seconds to chop. Add the drained chickpeas, tahini, lemon juice, water, and cumin to the work bowl. Pulse to chop, 10 times, then process 60 seconds; scrape the work bowl. With the machine running, add the oil in a slow steady stream; process until the hummus is smooth and creamy, about 3 minutes. Add half the chopped parsley; pulse to incorporate, 5 to 10 times. Allow the hummus to sit for 30 minutes before serving to allow the flavors to blend. Serve in a shallow bowl, sprinkled with the remaining chopped parsley. If desired, drizzle with extra virgin olive oil. Serve with pita wedges and vegetable crudités.

Nutritional analysis per tablespoon:

Calories 30 (49% from fat • carbo. 3g • pro. 2g • fat 2g • sat. fat 1g • chol. 0mg • sod. 33mg • fiber 1g

Variation:

Roasted Shallot & Herb Hummus

Wrap 8 ounces of peeled and trimmed shallots that have been tossed in 3/4 teaspoon extra virgin olive oil in heavy-duty foil and roast in a 400° F oven for 60 minutes. Let cool. Make the hummus according to the recipe, and add the cooled roasted shallots along with 1 tablespoon herbs de Provence when processing the chickpeas. Makes about 3 cups.

Jalapeño Jack Wafers

These savory wafers just melt in your mouth.

Preparation: 15 – 20 minutes,
plus 30 minutes resting time and 30 minutes baking and cooling

Makes 48 wafers

8	ounces Monterey Jack cheese	1/4	small onion (about the size of 2 walnuts)
1	small fresh jalapeño, seeded		
4	tablespoons unsalted butter	1	cup all-purpose flour
1	teaspoon dried cilantro		

Insert the shredding disc. Place cheese in large feed tube and shred, using light pressure; reserve. Remove shredding disc and insert metal blade. Add jalapeño and onion; process until coarsely chopped, about 5 to 10 seconds. Scrape work bowl. Add shredded cheese, butter and cilantro. Process until well blended and the mixture forms a ball, about 20 seconds. Scrape work bowl. Add flour and process until dough forms a ball, about 10 to 15 seconds.

Turn dough out onto plastic wrap and shape into a log approximately 12 inches long. Wrap in plastic wrap and chill for 30 minutes before using. May be made ahead to this point and refrigerated up to 3 days before using.

Preheat oven to 350°F. Slice logs into 1/4-inch pieces. Place on ungreased baking sheet. Bake until lightly browned on the bottom and edges, about 20 minutes. Cool on wire rack before serving.

Nutritional analysis per wafer:

Calories 47 (57% from fat) • carbo. 3mg • pro. 2g
fat 3g • sat. fat 2g • chol. 8mg • sod. 31mg • fiber 0g

Turkey Sausage & Sun-Dried Tomato Puff Pastry Pinwheels

Do-ahead prep makes these perfect for entertaining.

Makes 48

Oven temperature: 425° F

Preparation: 15 - 20 minutes, plus 1 hour to thaw puff pastry and roast the sausage, and 30 minutes baking time

- | | |
|--|---|
| 1/2 cup toasted walnuts | 12 ounces cream cheese, regular or reduced fat, not nonfat, cut in 1-inch cubes |
| 1-1/2 ounces Asiago cheese, cut in 1/2-inch pieces | 2 teaspoons basil |
| 6 sun-dried tomato halves, reconstituted in 1/2 cup boiling water until softened, squeezed dry | 1/2 teaspoon freshly ground pepper |
| 1 shallot (1-1/2 ounce) peeled and trimmed | 2 sheets frozen puff pastry, thawed for 1 hour in the refrigerator |
| 1/2 pound Italian turkey sausage, roasted and cooled, cut in 3/4-inch slices * | egg wash: 1 egg + 2 tablespoons water, beaten together |

Insert the metal blade. Place the walnuts in the work bowl. Pulse to chop, 5 times; remove and reserve. With the machine running, drop the cheese cubes down the small feed tube. Process for 30 seconds until chopped; remove and reserve. Put the sun-dried tomatoes in the work bowl and pulse 5 times to chop; remove and reserve. With the machine running, drop the shallots down the small feed tube; process for 5 seconds to chop. Scrape the work bowl. Add the cream cheese, basil and ground pepper to the bowl. Use the pulse to blend, about 5 to 10 times. Scrape the work bowl. Add the reserved chopped walnuts, Asiago cheese and sun-dried tomatoes. Use the pulse to blend, about 5 times. Remove and reserve.

On a lightly floured surface, roll out each sheet of puff pastry to 10 x 12 inches. Arrange the pastry on the work surface so that the long side is in front of you. Brush the top inch of the pastry with the egg wash, making a 1-inch edge. Using an offset or palette spatula, spread one third of the cream cheese mixture evenly on each of the puff pastry sheets. Roll the pastry jelly-roll style, evenly so that you roll into the egg-washed edge. Wrap in plastic wrap and refrigerate for at least 1 hour and up to 8. Cover and refrigerate the egg wash.

Preheat oven to 400°F. Slice the puff pastry into 28 slices, each 1/2 inch thick. (The sliced pinwheels may be frozen at this time. Freeze the slices on a plastic wrap lined baking sheet in a single layer. When frozen solid, transfer to a freezer bag. Double wrap the bag to keep out freezer odors. May be frozen up to 3 weeks). Arrange the puff pastry slices on a baking sheet about 1 inch apart. Lightly brush with the egg wash. Bake for 23 to 28 minutes, until puffed and golden. Serve hot/warm. If desired, they may be baked ahead. Bake until light golden; cool, then refrigerate until ready to serve. Reheat in a 300°F oven for about 5 minutes.

*To roast the turkey sausage, prick the sausage several times with a fork, rub lightly with about a 1/2 teaspoon of olive oil, then roast on a foil lined pan at 350°F for 25 to 30 minutes, turning after 15 minutes.

Nutritional analysis per serving:

Calories 81 (62% from fat) • carbo. 5g • pro. 3g • fat 6g
sat. fat 1g • chol. 11mg • sod. 154 mg • fiber 0g

Spinach, Feta & Artichoke Stuffed Mushrooms

For a savory side dish, use this stuffing in portobellos.

Makes 28 1-1/2 inch stuffed mushrooms

Preparation: 15 - 20 minutes, plus 30 minutes baking and cooling

28	1-1/2 inch white button or cremini mushrooms	1	shallot, about 1 ounce, peeled
1-1/2	ounces French bread, cut in 1-inch pieces	12	ounces fresh spinach, well washed and dried, tough stems removed
1-1/2	ounces Asiago cheese	3/4	teaspoon Herbes de Provence
1/3	cup lightly toasted pine nuts or walnuts	3	ounces feta cheese, slightly crumbled
3	canned artichokes, well drained, then gently squeezed in paper towels to remove excess moisture	3	ounces cream cheese (regular, not low or nonfat), cut into 1-inch pieces
1	clove garlic		

Insert the metal blade. Place the bread in the work bowl and process for 45 seconds to make crumbs. Measure out 1/3 cup of the breadcrumbs and reserve in a small bowl – save the remainder for another use. With the machine running, drop the Asiago cheese down the small feed tube and process for 30 seconds until ground. Add the pine nuts; pulse 5 times to coarsely chop. Transfer this mixture to the bowl with the breadcrumbs. Pulse to chop the artichokes, about 10 times. Add to the breadcrumb mixture and set aside.

With the machine running, drop the garlic and shallot through the small feed tube; process 5 seconds to chop. Scrape the work bowl. Add the spinach, about 2 ounces at a time; pulse 10 to 12 times to chop after each addition. Add the Herbes de Provence, feta and cream cheese; process for 20 seconds to incorporate. Add the reserved breadcrumb mixture; pulse about 10 to 12 times to incorporate. The stuffing may be made up to 2 days ahead.

Rinse but do not soak the mushrooms; dry thoroughly. Remove the stems. (The stems may be chopped finely using the metal blade and pulse, then sautéed in a tablespoon of unsalted butter. This mixture may be frozen, then used in soups, stews, savory dressings or pilafs.)

Preheat oven to 425°F. Stuff each mushroom with a scant tablespoon of the spinach mixture. Arrange in a shallow baking dish that has been lightly coated with olive oil – do not crowd. The mushrooms may be stuffed up to 8 hours ahead. If making ahead, cover and refrigerate.

Bake the mushrooms in the preheated oven for 20 to 25 minutes. Allow to rest for 5 minutes before serving.

Nutritional analysis per serving:

Calories 47 (57% from fat) • carbo. 3g • pro. 2g • fat 3g
sat. fat 1g • chol. 6mg • sod. 97mg • fiber 2 g

Soups

Butternut Squash Bisque with Roasted Cremini Mushrooms

*Most cream soups are laden with heavy cream and fat.
This Cuisinart soup uses half & half and rice to make it rich and creamy.*

Makes eight 7-ounce servings

Preparation: 40 to 45 minutes

12	ounces Cremini mushrooms, stems removed and reserved	2	teaspoons curry powder
1-1/2	tablespoons extra virgin olive oil	2	tablespoons white rice
1	medium onion (about 6 ounces), cut in 1-inch pieces	3	cups low salt, nonfat chicken or vegetable stock
1	clove garlic, peeled	1-1/2	teaspoons freshly squeezed lemon juice
2	pounds butternut squash, peeled, seeded and cut to fit large feed tube	1	tablespoon honey
1	sweet potato (about 10 ounces)	1/2	teaspoon kosher salt
1	tablespoon unsalted butter	1/4	teaspoon freshly ground pepper
		1/2	cup half-and-half

Preheat the oven to 400°F. Line a baking sheet with foil. Insert the slicing disc. Arrange the mushrooms vertically in the large feed tube, packing them snugly in 2 layers. Use medium pressure to slice. Toss the sliced mushrooms with the olive oil; arrange in a single layer on the baking sheet. Roast in the preheated oven for 20 to 25 minutes, until well browned and no longer sitting in liquid. The mushrooms may be roasted ahead.

Insert the metal blade. With the machine running, drop the garlic through the feed tube and process to chop finely, 5 seconds. Scrape the work bowl. Add the onion and reserved mushroom stems to the bowl. Pulse to chop coarsely, 10 to 15 times. Remove and reserve.

Insert the shredding disc. Use medium pressure to shred the squash; remove and reserve. Peel the sweet potato; cut in half crosswise. Use medium pressure to shred the sweet potato; remove and reserve.

Melt the butter in a 6-quart stock pot over medium heat. Add the onion, mushroom and garlic mixture; cook for 2 to 3 minutes. Stir in the curry powder and rice; cook until the curry becomes aromatic and the rice is opaque, about 5 minutes. Stir in the shredded squash, sweet potato and chicken stock. Cover loosely and bring to a boil, then reduce the heat and simmer for 20 minutes.

Strain the solids, reserving the cooking liquid. Transfer the cooking liquid to a saucepan over very low heat and reserve. Insert the metal blade. Add the solids to the food processor, pulse 10 times, then process to purée, 2 to 3 minutes. Scrape the work bowl every 60 seconds. Return the puréed solids to the cooking liquid and stir to incorporate. Add the lemon juice, honey, salt and pepper. Stir in the roasted mushrooms and any accumulated juices. Taste and adjust seasonings if necessary. (The bisque may be done up to a day ahead to this point. If doing ahead, allow the soup to cool, then cover and refrigerate. Just before service, reheat the soup.) Stir in the half-and-half, heat for 1 minute, then serve.

Nutritional analysis per serving:

Calories 108 (34% from fat) • carbo. 15g • pro. 3g • fat 4g
sat. fat 2g • chol. 6mg • sod. 138mg • fiber 2g

Chilled Roasted Red Bell Pepper & Corn Soup

Low in fat and calories, this soup is very refreshing on a hot summer day.

Makes eight 7-ounce servings

Preparation: 30 - 35 minutes, plus chilling time

2	cloves garlic, peeled	1-1/2	teaspoons thyme
2	medium onions (4 ounces each), peeled, cut into 1-inch pieces	4	tablespoons white rice
3	red bell peppers (approximately 1-1/2 pounds total), seeded, trimmed and cut into 1-inch pieces	4-1/2	cups low salt, nonfat chicken or vegetable stock
3	ears fresh corn	1	teaspoon kosher or sea salt
1	tablespoon extra virgin olive oil	1/2	teaspoon freshly ground pepper
		1	12-ounce jar roasted red peppers
		3-5	drops hot sauce, to taste

Insert the metal blade. With the machine running, drop the garlic cloves down the small feed tube and process until finely chopped, about 5 seconds. Scrape the work bowl. Add the onions; pulse to chop, 15 times. Remove and reserve. Use the pulse to chop the red bell pepper, 10 to 15 times. Remove and reserve.

Use a thin-bladed knife (a boning knife works well) to remove the corn from the cobs. Reserve the cobs.

Heat the oil in a 6-quart stockpot over medium heat. Add the chopped onions, garlic, and red bell peppers. Allow the vegetables to cook for 2 to 3 minutes – do not brown. Stir in the corn, cobs, thyme, and rice; cook for 2 to 3 minutes longer. Add the chicken stock and roasted peppers; raise the heat and bring to a boil. Reduce heat, cover loosely and simmer for 20 minutes.

Remove the corncobs and discard. Strain the solids from the cooking liquid. Reserve the cooking liquid. Insert the metal blade. Process the solids for 4 minutes to purée, stopping the machine two or three times to scrape the work bowl. Add the purée into the reserved cooking liquid and stir to combine. Add salt and pepper; stir well to combine. Season with hot sauce and chill before serving.

Note: This soup may also be served hot.

Nutritional analysis per serving:

Calories 98 (18% from fat) • carbo. 17g • pro. 3g • fat 2g
sat. fat 0g • chol. 0mg • sod. 186mg • fiber 2g

Gazpacho

Always served well chilled, this summertime favorite has its origins in the Andalusian region of Spain.

Makes six 7-ounce servings

Preparation: 15 - 20 minutes, plus chilling time

1	garlic clove, peeled	3	cups tomato juice
1	medium jalapeño pepper, seeded, cut into 1-inch pieces	1	medium cucumber, peeled, cut in half lengthwise, seeds removed
1/3	cup fresh cilantro	3	tablespoons fresh lime juice
6	small scallions, trimmed, cut into 1-inch pieces	1/2	teaspoon coarsely ground black pepper
1	small green bell pepper, cored, seeded, cut into 1-inch pieces	1/8	teaspoon kosher salt
3	medium tomatoes, cored, cut into 1-inch pieces	6	teaspoons reduced fat sour cream
			Fresh cilantro for garnish, if desired

Insert metal blade and process garlic and jalapeño until finely chopped, about 5 seconds. Scrape the work bowl. Add cilantro, scallions and green pepper; pulse to coarsely chop, about 10 to 12 times. Transfer to a large mixing bowl. Place tomatoes in work bowl and pulse to coarsely chop, about 8 times. Do not overprocess. Transfer to mixing bowl. Add tomato juice to tomato mixture and stir to combine.

Insert the slicing disc. Place cucumber in feed tube vertically and slice. Add to mixing bowl. Add lime juice, pepper and salt to mixing bowl and stir to combine. Cover and chill before serving.

Serve garnished with 1 teaspoon sour cream and a fresh cilantro sprig.

Nutritional analysis per serving:

Calories 63 (9% from fat) • carbo. 13g • pro. 2g • fat 1g
sat. fat 0g • chol. 1mg • sod. 378mg • fiber 2g

Quick Breads

Cranberry - Orange Bread

Apples make this bread very moist - for a breakfast treat, slice and toast.

Makes 1 loaf (16 servings)

Preparation: 10 - 15 minutes, plus 2 hours baking and cooling

Cooking spray	1	medium apple (about 7 ounces), peeled, cored, cut into 1-inch pieces
1-1/2 cups unbleached all-purpose flour	2	large eggs
2 teaspoons baking powder	3/4	teaspoon vanilla extract
1/4 teaspoon salt	1/3	cup unsalted butter, melted
1 cup pecan halves, shells removed	1/4	cup buttermilk
4 strips orange zest	1/2	cup dried cranberries
3/4 cup sugar		

Preheat oven to 350°F. Lightly spray a 9 x 5-inch loaf pan with cooking spray. In a small bowl combine flour, baking powder and salt. Reserve. Insert metal blade and pulse to coarsely chop pecans, about 6 times. Reserve.

Process orange zest and sugar until zest is finely chopped, about 45 seconds. Add apples, eggs and vanilla; process until combined, about 15 to 20 seconds. With machine running, add butter and buttermilk through the small feed tube. Process until combined, about 10 to 15 seconds. Add cranberries, pecans and dry ingredients. Pulse until flour is just mixed in, about 5 to 6 times. Do not overprocess.

Transfer batter to prepared pan. Bake until golden brown and a toothpick inserted in the center comes out clean, about 60 to 65 minutes. Cool in pan on a wire rack. Remove from pan and cool completely. For best results, wrap in plastic wrap and allow to rest for 24 hours before slicing.

Nutritional analysis per serving:

Calories 176 (41% from fat) • carbo. 24g • pro. 2g • fat 8g
sat. fat 3g • chol. 24mg • sod. 103mg • fiber 1g

Banana Nut Bread

Wrap and freeze individual slices for a healthy lunchbox snack.

Makes 1 loaf (14 servings)

Preparation: 10 - 15 minutes, plus 2 hours baking and cooling

Cooking spray	1	large egg white
1-1/3 cups unbleached all-purpose flour	2/3	cup sugar
1/4 cup walnut halves, shells removed	1/3	cup plain nonfat yogurt
3/4 teaspoon baking powder	2-1/2	tablespoons unsalted butter, in 1-inch pieces
3/4 teaspoon baking soda	1-1/4	teaspoons vanilla extract
1/4 teaspoon salt		
1-1/2 ripe bananas (about 8 ounces total), peeled, cut into 1-inch pieces		
1 large egg		

Preheat oven to 350°F. Lightly spray a 9 x 5-inch loaf pan with cooking spray. Insert metal blade. Pulse to combine flour, nuts, baking powder, baking soda and salt, about 5 times. Reserve.

Process banana until puréed, about 30 seconds. Scrape work bowl and process an additional 10 seconds. Add egg, egg white, sugar, yogurt, butter and vanilla extract. Process until well combined, about 10 to 15 seconds. Add dry ingredients. Pulse until flour is just mixed in, about 5 to 6 times.

Pour into prepared pan. Bake until golden brown and a toothpick inserted in the center comes out clean, about 50 minutes. Cool in pan on a wire rack for 20 minutes. Remove from pan and cool completely on wire rack.

Muffin variation:

Lightly spray 12 standard (1/2-cup) muffin cups with vegetable oil cooking spray. Divide the batter evenly among the 12 cups. Bake at 350°F for 16 to 20 minutes. For variety, add 1/3 cup chocolate chips when pulsing in the flour mixture.

Nutritional analysis per serving:

Calories 131 (28% from fat) • carbo. 22g • pro. 3g • fat 4g
sat. fat 0g • chol. 21mg • sod. 125mg • fiber 1g

Almond-Pear Bread

Almonds and pears combine to make this rich, moist tea bread.

Makes 12 servings

Preparation: 20 - 25 minutes, plus 2-1/2 hours baking and cooling

Paste:	2	tablespoons plus 1 teaspoon water
3/4 cup blanched almonds	1/4	teaspoon almond extract
1/2 cup sugar		
Bread:	3/4	pound ripe pears, peeled, cored, cut into 1-inch pieces
Cooking spray	2	large eggs
1/2 cup sliced almonds	3/4	cup almond paste, broken into 1-inch pieces
1-1/4 cups unbleached all-purpose flour	1/3	cup unsalted butter, softened, cut into 1-inch pieces
2 teaspoons baking powder		
1/2 teaspoon salt		
1/4 teaspoon baking soda		

To make paste:

Insert the metal blade. Process blanched almonds and sugar until finely ground, about 60 seconds. With machine running, add water and extract; process until combined, about 45 to 60 seconds longer. Paste can be made ahead and stored in the refrigerator in an airtight container for up to two weeks.

To make bread:

Preheat oven to 350°F. Lightly coat one 9 x 5 inch loaf pan with cooking spray. Toast sliced almonds on a baking sheet until lightly browned, about 8 to 10 minutes. In a small bowl combine flour, baking powder, salt and baking soda; reserve.

Insert metal blade and process pears, egg, almond paste and butter until combined, about 30 seconds. Scrape bowl and process an additional 30 to 45 seconds. Add toasted almonds and reserved dry ingredients. Pulse to combine, about 6 to 7 times. Pour into prepared pan and bake until golden brown on top and a toothpick inserted in the center comes out clean, about 1 hour. Cool on wire rack for 30 to 40 minutes. Remove from pan and cool completely on wire rack. For best results, wrap bread in plastic wrap and allow to rest for 24 hours before slicing. Freezes well.

Nutritional analysis per serving:

Calories 237 (49% from fat) • carbo. 25g • pro. 5g • fat 13g
sat. fat 4g • chol. 49mg • sod. 217mg • fiber 1g

Yeast Breads

Challah Braid

If you have leftovers, our Challah Braid slices make the best French toast.

Makes 18 servings (one 2-pound loaf)

Preparation: 15 - 20 minutes, plus 2-1/2 hours rising and resting,
30 minutes baking and 1 hour or longer cooling

4	tablespoons sugar, divided	2/3	cup cold water
1	package active dry yeast	1/2	cup unsalted butter, melted
1/4	cup warm water (105° - 115°F)	1	large egg
4-1/3	cups unbleached all-purpose flour	1	tablespoon water
2	teaspoons salt		Cooking spray

In a 2-cup liquid measure, dissolve 2 teaspoons sugar and yeast in warm water. Let stand until foamy, about 5 minutes.

Insert the dough blade in the work bowl and add flour, remaining sugar and salt. Pulse on dough speed to combine, about 2 to 3 times.

Add cold water, melted butter and 1 egg to yeast mixture. With machine running on dough speed, add liquid through small feed tube in a steady stream as fast as the flour will absorb it. Once dough forms a ball, continue processing for 45 seconds to knead dough. Place dough in a floured plastic food storage bag and seal. Let rise in a warm place until doubled in size, about 1 to 1-1/2 hours.

Place dough on a lightly floured surface and punch down; let rest 5 to 10 minutes. Divide dough into 3 equal pieces. Use your hands to roll each piece into a cylinder about 1-1/2 x 18 inches. Place the cylinders side by side on a baking sheet coated with cooking spray. Braid loosely from one end. Gently pull and taper each end to a point, then pinch and tuck under loaf. Cover with plastic wrap coated with vegetable oil cooking spray and let rise until doubled in size, about 45 minutes. Preheat oven to 375°F 15 minutes before baking.

Beat egg with water and brush over braid. Bake in lower third of preheated oven for 20 minutes. Lower temperature to 350°F and bake until loaf is browned and sounds hollow when tapped, about 10 minutes. Cool on wire rack.

Nutritional analysis per serving:

Calories 174 (31% from fat) • carbo. 26g • pro. 4g • fat 6g
sat. fat 3g • chol. 37mg • sod. 267mg • fiber 1g

Cheese Bread

This bread is excellent for sandwiches and makes a delicious accompaniment to hearty soups.

Makes 15 servings (one 2 pound loaf)

Preparation: 10 - 15 minutes, plus 2-1/4 hours rising,
40 minutes baking, and 1 hour or longer cooling

1	package active dry yeast	3	tablespoons unsalted butter, in 1-inch pieces
1	teaspoon sugar		
1/2	cup warm water (105° - 115°F)	1-1/2	teaspoons salt
4	ounces extra sharp cheddar cheese	1	cup fat-free milk
4-1/2	cups unbleached all-purpose flour		Cooking spray

In a 2-cup liquid measure, dissolve yeast and sugar in warm water. Let stand until foamy, about 5 minutes.

Insert medium shredding disc and shred cheese. Leave in work bowl. Remove shredding disc and insert dough blade. Add flour, butter and salt; process to combine, about 20 seconds. Add milk to yeast mixture. With machine running on dough speed, pour milk mixture through small feed tube as fast as the flour will absorb it and process until dough cleans the sides of the work bowl. Then process for 45 seconds to knead dough. Place dough in a lightly floured plastic food storage bag and seal top. Let rise in a warm place until doubled in size, about 1 to 1-1/2 hours.

Spray one 9 x 5-inch loaf pan with cooking spray. Place dough on a lightly floured surface and punch down. Roll dough into a 9 x 5-inch rectangle. Beginning with short end, roll up the dough jelly roll fashion. Pinch the seam and ends tightly to seal. Place in greased loaf pan and cover with plastic wrap coated with vegetable oil cooking spray. Let rise for 45 minutes. Preheat oven to 375°F 15 minutes before baking.

Bake until top is well browned and loaf sounds hollow when tapped, about 35 to 40 minutes. Remove from pan and cool on wire rack.

Nutritional analysis per serving:

Calories 193 (23% from fat) • carbo. 30g • pro. 7g • fat 5g
sat. fat 3g • chol. 14mg • sod. 289mg • fiber 1g

Classic Cuisinart White Bread

Spoil your family with homemade bread.

Makes 18 servings (2 loaves, 1-1/4 pounds each)

Preparation: 10 - 15 minutes, plus 2-1/2 hours rising and resting, 35 minutes baking, and 1 hour or longer cooling

1	package active dry yeast	4	tablespoons unsalted butter, in 1-inch pieces
1	tablespoon sugar	2	teaspoons salt
1/3	cup warm water (105° - 115°F)	1-1/3	cups cold water
5	cups unbleached all-purpose flour		Cooking spray

In a 2-cup liquid measure, dissolve yeast and sugar in warm water. Let sit until foamy, about 5 minutes.

Insert dough blade. Process flour, butter and salt on dough speed until combined, about 10 to 15 seconds. Combine yeast mixture and cold water. With machine running on dough speed, add liquid through small feed tube as fast as flour will absorb it. Once dough cleans the sides of the work bowl and forms a ball, process for 45 seconds to knead dough. Place dough in a lightly floured plastic food storage bag and seal the top. Allow to sit in a warm place until doubled in size, about 1 to 1-1/2 hours.

Spray two 9 x 5-inch loaf pans with cooking spray. Place dough on a lightly floured surface and punch down. Divide dough in half and roll each half into a 9 x 5-inch rectangle. Beginning with short end, roll up the dough jelly roll fashion. Pinch the seam and ends tightly to seal. Place in greased loaf pans and cover with plastic wrap coated with vegetable oil cooking spray. Let rise until dough is just above the tops of the pans, about 45 minutes to 1 hour. Preheat oven to 400°F 15 minutes before baking.

Bake until tops are browned and loaf sounds hollow when tapped, about 30 to 35 minutes. Remove from pans and cool on wire rack.

Variation: To make Classic Cuisinart Wheat Bread, substitute 2 1/2 cups whole wheat flour for 2 1/2 cups of the unbleached all-purpose flour.

Nutritional analysis per serving:

Calories 151 (18% from fat) • carbo. 27g • pro. 4g • fat 3g
sat. fat 2g • chol. 7mg • sod. 260mg • fiber 3g

Pizza Dough

*Once you see how simple Cuisinart pizzas are to make,
you will never order one to be delivered again.*

Makes 1-3/4 pound dough, three 12-inch or six 6-7-inch crusts / 6 servings

Preparation: 5 - 10 minutes, plus 55 minutes rising and resting,
5 minutes assembly and 10 minutes baking

2	teaspoons active dry yeast	3-1/3	cups unbleached all-purpose flour
1	teaspoon sugar	1-1/2	teaspoons kosher salt
1-1/4	cups warm water (105° - 115°F)	3	teaspoons extra virgin olive oil

In a 2-cup liquid measure, dissolve yeast and sugar in warm water. Let stand until foamy, about 3 to 5 minutes. Insert dough blade in work bowl and add flour, salt and 2 teaspoons olive oil.

With machine running on dough speed, pour liquid through small feed tube as fast as flour will absorb it. Process until dough cleans sides of work bowl and forms a ball. Then process for 30 seconds to knead dough. Dough may be slightly sticky. Coat dough evenly with 2 teaspoons olive oil; transfer to a plastic food storage bag and seal the top. Let rise in a warm place for about 45 minutes. While dough is rising, prepare any pizza toppings.

Place dough on a lightly floured surface and punch down. Roll into desired crust sizes. Follow pizza recipe.

Nutritional analysis per serving:

Calories 259 (10 % from fat) • carbo. 49g • pro. 8g • fat 3g
sat. fat 0g • chol. 0mg • sod. 337mg • fiber 2g

Artisan Breads

Basic Artisan Bread

Adapted from: Charles van Over,

The Best Bread Ever:

Great Home Made Bread Using Your Food Processor, Broadway Books, 1997

Makes two 10-inch round loaves (boules)

Preparation: 30 minutes, plus 2-1/2 - 3 hours rising time,
40 minutes baking time and 1 hour or longer for cooling

- | | | |
|---|---|---------------------------------------|
| 1 | pound unbleached bread flour
(3-1/3 to 4 cups) | 1-1/4 cups water (10 ounces) |
| | | Cornmeal for the peel or baking sheet |
| 2 | teaspoons fine sea salt | |
| | | Flour for dusting |
| 1 | teaspoon instant yeast | |

Insert the dough blade. Combine the flour, salt, and yeast in the work bowl. Test the temperature of the flour mixture using an instant read thermometer. Adjust the water temperature so that the individual temperatures of the flour and water when combined equal 145°F (i.e. if the flour is 70°F, then the water must be 75°F.) This is the base temperature. With the machine running on dough speed, add the water through the small feed tube and process for 45 seconds. Transfer the dough to a large ungreased bowl. Cover with plastic wrap and let rise for about 1-1/2 to 2 hours at room temperature.

Move the uppermost rack of the oven so that it is about 8 inches from the top of the oven and place a baking stone on the rack. Place a small cast-iron skillet to preheat on the floor or lower rack of the oven. Preheat the oven to 475°F.

When risen, scrape the dough onto a lightly floured work surface. Divide into two equal pieces and shape into rough balls. Let rest, covered, for 15 to 20 minutes. Roll into two balls, 9 inches in diameter. Place on a cornmeal dusted baking sheet. Cover with plastic wrap and let rise for 30 to 45 minutes, until the dough increases in size by 50 percent. The dough will feel soft, but spring back when poked with your finger.

Gently transfer the loaves onto a baker's peel or the back of a baking sheet that has been dusted with cornmeal, taking care not to deflate the loaves. Sprinkle top of each loaf with flour. Using a serrated knife, score each loaf with four slashes to make a tic-tac-toe pattern on the top of each loaf.

Carefully slide the loaves onto the baking stone, then carefully pour about 1 cup of warm water into the cast-iron pan. Reduce the heat to 450°F. Bake the loaves for 30 to 40 minutes, until the crust is a deep mahogany color and the loaves sound hollow when tapped on the bottom. The internal temperature of the bread will be 205°- 210°F when tested with an instant read thermometer. Remove from the oven and place on a rack to cool completely before slicing or storing.

Nutritional analysis per 2-ounce serving:

Calories 139 (3% from fat) • pro. 5g • carbo. 29g • fat 0g
sat. fat 0g • chol. 0mg • sod. 377mg • fiber 0g

Basic Artisan Bread

(variation)

To make baguettes

Makes three, about 14 inches long.

When risen, scrape the dough onto a lightly floured work surface. Divide the dough into three equal pieces; shape into rough balls. Let rest, covered with plastic wrap, 15 to 20 minutes. Sprinkle a sheet of canvas or a heavy linen cloth lightly with flour.

Flatten into 4 x 5-inch rectangles. From the far side, fold a little over 2/3 of the way toward you; use the heel of your hand and press the folded edge to seal. Turn the dough 180°; fold over the other long edge 2/3 of the way, then seal with the palm of your hand. Fold the log in half lengthwise, using your thumbs to create tension on the surface of the log. Use fingertips to seal the dough into a taut cylinder. Place both hands on the center of the log; with fingers spread, use light, uniform pressure to roll the dough back and forth to create a long snake, about 14 inches. Transfer the baguettes, seam side up, to the floured cloth. Fold the cloth up to form channels in which each loaf will rise. Cover with plastic wrap and let rise for 30 to 45 minutes, until the dough increases in size by 50 percent.

Gently transfer the loaves seam side down onto a baker's peel or the back of a baking sheet dusted with cornmeal. Sprinkle the tops with flour. Use a serrated knife to score several diagonal slices on each loaf. Bake as for the round loaves, 20 to 25 minutes, until the crust is a deep mahogany color and the loaves sound hollow when tapped on the bottom. The internal temperature of the bread will be 205° - 210°F when tested with an instant read thermometer. Remove from the oven and place on a rack to cool completely before slicing or storing.

Nutritional analysis per 2-ounce serving:

Calories 139 (3% from fat) • pro. 5g • carbo. 29g • fat 0g
sat. fat 0g • chol. 0mg • sod. 377mg • fiber 0g

Olive and Rosemary Country Loaf

Adapted from: Charles van Over,

*The Best Bread Ever: Great Home Made Bread Using Your Food Processor,
Broadway Books, 1997*

Salty olives such as kalamata should be rinsed to remove some of their brine; oil cured olives will produce a more mellow flavor. Olive lovers may add an additional quarter cup of olives.

Makes one loaf

Preparation: 30 minutes, plus 3 to 3-1/2 hours rising time,
30 minutes baking time, and 1 hour or longer for cooling

10	ounces unbleached bread flour (2-1/4 to 2-3/4 cups)	1-1/4	cups water (10 ounces)
5	ounces whole wheat flour (1 cup)	1/2	cup pitted and coarsely chopped imported black olives
1	ounce rye flour (1/4 cup)	1	tablespoon chopped fresh rosemary
2	teaspoons fine sea salt		Whole rosemary sprigs for garnish, cut into 1- inch lengths
1	teaspoon instant yeast		Cornmeal for the peel or baking sheet
1	teaspoon extra virgin olive oil		Flour for dusting

Insert the dough blade. Combine the flour, salt, yeast and olive oil in the work bowl. Test the temperature of the flour mixture using an instant read thermometer. Adjust the water temperature so that the individual temperatures of the flour and water when combined equal 145°F (i.e. if the flour is 70°F, then the water must be 75°F). This is the base temperature. With the machine running on dough speed, add the water through the small feed tube and process for 45 seconds. Transfer the dough to a large ungreased bowl. Cover with plastic wrap and let rise for about 1-1/2 to 2 hours at room temperature.

Move the uppermost rack of the oven so that it is about 8 inches from the top of the oven and place a baking stone on the rack. Place a small cast-iron skillet to preheat on the floor or lower rack of the oven. Preheat the oven to 475°F.

Scrape the dough onto a lightly floured work surface. Flatten into a 12-inch square using the palms of your hands. Sprinkle with the chopped olives and chopped rosemary. Fold the dough over onto itself and knead for 3 to 4 minutes to thoroughly incorporate the olives and rosemary. If the dough is difficult to knead, cover with a towel and let rest for 10 minutes, then continue kneading.

Form into a round loaf. Sprinkle a cloth-lined basket or banneton with flour. Place the dough in the basket, with the seam showing on top of the loaf on top. Dust with flour and loosely cover with plastic wrap. Allow the dough to rise at least 1 hour at room temperature. It will be visibly risen and spring back when gently pressed with a finger.

Just before baking, gently invert the bread rising basket onto a baker's peel or the back of a baking sheet that has been dusted with cornmeal. Sprinkle the top of the loaf with additional flour. Using a serrated knife, score the dough in a star pattern – starting from the center, make a short 3-inch slash. Rotate the bread and continue slashing until a star pattern is formed on the top of the dough. Insert a few sprigs of rosemary into the surface of the dough.

Slide the loaf onto the baking stone, and then carefully pour 1 cup of warm water into the cast-iron pan in the oven. Reduce the heat to 450°F. Bake the bread for 30 minutes, and then reduce the temperature to 425°F and bake for an additional 15 minutes. The crust will be well browned and the loaves will sound hollow when tapped on the bottom. The internal temperature of the bread will be 205° to 210°F when tested with an instant read thermometer. Remove the bread from the oven and place on a rack to cool completely before slicing or storing.

Nutritional analysis per 3-ounce serving:

Calories 249 (from fat 20%) • pro. 7g • carbo. 42g • fat 5g
sat. fat 1g • chol. 0mg • sod. 724mg • fiber 4g

Simple Wheat Starter

Adapted from: Charles van Over, The Best Bread Ever:

Great Home Made Bread Using Your Food Processor, Broadway Books, 1997

Makes about 5 cups

Preparation: 20 minutes, plus 3 to 4 days for fermentation

A starter is a type of natural yeast that makes bread rise and gives it a full, rich flavor. For best results, make this starter in a large, clear glass or plastic container (2-quart) with graduated markings. Mark the level of your beginning starter with a piece of tape and watch the gas bubbles develop as the yeast activates. Once the starter has developed, store it in the refrigerator until you are ready to use it. The starter must be fed once a week to keep it alive. Always feed a starter 2 to 4 hours prior to using it. To feed the starter, remove it from the refrigerator; stir in 1 cup of flour and 1/2 cup of water. The consistency should be like light pancake batter. After feeding, leave the starter out at room temperature before using or refrigerating it. SAF yeast is highly recommended for this and the other Artisan Bread recipes. The starter process takes 42 to 56 hours before starter is ready to use.

12	ounces unbleached flour	2	cups water (16 ounces)
2	ounces whole wheat flour	1/4	teaspoon instant yeast

In a small bowl, combine 1/2 cup of each flour with 1 cup of the water and the yeast. Stir well to blend; the mixture will be sticky and have the texture of wallpaper paste. Transfer to a 2-quart container and cover with plastic wrap. Mark the level of the starter and the time mixed on the side of the container with masking tape. Let sit at room temperature (70-72°F) for 18 to 24 hours.

Uncover the starter; it will have almost doubled in bulk. Add 3/4 cup of the all-purpose flour and 1/2 cup of the water. Mark again with the level and time. Let sit at room temperature for 18 to 24 hours.

Uncover the starter; it will be doubled in bulk and full of bubbles. Discard half or give to a friend with directions. Add the remaining flours and water. Mix well. The mixture will have the consistency of thick pancake batter. If it is too thick, add more water – too thin, add more flour. Cover with plastic wrap. Mark the level and time, and let sit at room temperature for another 6 to 8 hours. The basic starter is now ready to use.

Nutritional analysis per half cup:

Calories 165 (from fat 3%) • pro. 5g • carbo. 34g • fat 0g
sat. fat 0g • chol. 0mg • sod. 2mg • fiber 1g

Multi-Grain Sandwich Loaf

*Adapted from: Charles van Over, The Best Bread Ever:
Great Home Made Bread Using Your Food Processor, Broadway Books, 1997*

*A mountainous loaf full of the nutty taste of whole grains,
the Multi Grain Sandwich loaf may also be shaped into a plump round loaf.*

Makes one 24-ounce loaf

Preparation: 30 to 35 minutes, plus 2 hours to activate the Simple Wheat Starter, 3 to 3-1/2 hours rising time, 40 minutes baking time, and 1 hour or longer for cooling

1/2	cup Active Simple Wheat Starter (measure after feeding and resting)	2	ounces 7-grain cereal (1/2 cup)
8	ounces unbleached bread flour (1-3/4 to 2-1/4 cups)	1-1/2	teaspoons fine sea salt
2	ounces whole wheat flour (1/2 cup)	1/2	teaspoon instant yeast
1	ounce rye flour (1/4 cup)	1	cup water
1	ounce graham flour (1/4 cup)		Vegetable oil for the pan

Two to four hours before mixing this dough, feed your Simple Wheat Starter. Allow the starter to sit at room temperature until it is frothy, bubbly and visibly active.

Insert the dough blade. Add the flours, 7-grain cereal, salt, yeast and starter to the work bowl. Test the temperature of this mixture with an instant read thermometer. Adjust the water temperature so that the individual temperatures of the flour mixture and water when combined equal 145°F (i.e., if the flour mixture is 70°F, then the water temperature must be 75°F). This is the base temperature. With the machine running, pour all but 3 tablespoons of water through the small feed tube; process for 15 seconds. The dough should come together and form a visible ball. Add the reserved water if the dough seems dry and crumbly. If the dough is wet and sticking to the shaft and sides of the bowl, sprinkle in a few spoonfuls of flour. Process for 30 seconds, so that the dough mixes a total of 45 seconds. This dough will be soft, moist and somewhat sticky.

Scrape the dough onto a lightly floured work surface. Lightly flour the dough, shape into a rough ball and place in a large ungreased bowl. Cover the bowl with plastic wrap. Allow the dough to ferment for about 2 to 3 hours at room temperature. The dough will double in volume.

Brush an 8 x 4-inch loaf pan with vegetable oil. Turn the dough onto a generously floured work surface. Use your fingertips to lightly pat the dough into a rectangle about 10 inches long and 2 inches thick. Roll the dough into a log. Tuck in the ends and place the dough in the pan, seam-side down. Lightly dust the dough with flour and loosely cover with plastic wrap or a kitchen towel. Let the dough rise for about 1 to 1-1/2 hours at room temperature. Arrange the oven rack on the second shelf from the bottom of the oven; place a baking stone on the rack. Preheat the oven to 475° F.

Dust the proofed loaf with flour. Make a 1/4-inch slash down the center of the loaf with a serrated knife. Slide the loaf pan into the oven onto the baking stone. Turn the heat down to 425° F. Bake the bread for 20 minutes, then rotate the pan in the oven for even baking and bake another 15 to 20 minutes, until the crust is deep brown. Take the loaf out of the pan and place directly on the baking stone; bake for another 5 to 10 minutes. The loaf is ready when it sounds hollow when tapped on the bottom and the internal temperature is 205° to 210° F when tested with an instant read thermometer. Remove from the oven and place on a wire rack to cool before slicing or storing. Store under a towel or in a paper bag at room temperature. The Multi-Grain Sandwich Loaf will stay fresh for three days.

Nutritional analysis per 2-ounce serving:

Calories 137 (from fat 5%) • pro. 5g • carbo. 28g • fat 1g
sat. fat 0g • chol. 0mg • sod. 302mg • fiber 2g

Farm House Bread

“Long Cool Rise” Adapted from: Charles van Over,

*The Best Bread Ever: Great Home Made Bread Using Your Food Processor,
Broadway Books, 1997*

The two long rising periods – one at room temperature and a second in the refrigerator – give this bread a rich and subtle sour flavor in the tradition of the great breads made in European farmhouse kitchens in the past. This dough is very forgiving; you can mix it in the morning and bake at night or mix late in the day to bake early the next morning.

Makes two long loaves

Preparation: 30 minutes, plus 2 hours to activate the Simple Wheat Starter, 10 to 18 hours rising time, 25 minutes baking time, and 1 hour or longer for cooling

1/2 cup Active Simple Wheat Starter (measure after feeding and resting)	scant 1/2 teaspoon instant yeast
12 ounces unbleached bread flour (3-1/4 to 4 cups)	1 cup water (8 ounces)
1 ounce stone-ground whole wheat flour	Cornmeal for the peel or baking sheet
1-1/2 teaspoons fine sea salt	Flour for dusting

Two to four hours before mixing this dough, feed your Simple Wheat Starter. Allow the starter to sit at room temperature until it is frothy, bubbly and visibly active.

Insert the dough blade. Combine the flours, salt, yeast, and starter in the work bowl. Test the temperature of the flour mixture using an instant read thermometer. Adjust the water temperature so that the individual temperatures of the flour mixture and water when combined equal 145°F (i.e. if the flour is 75°F, then the water must be 70°F). This is the base temperature. With the machine running, add the water through the small feed tube and process for 45 seconds. Transfer the dough to a large ungreased bowl. Cover with plastic wrap and let rise for about 3 to 5 hours at room temperature.

Place the bowl of risen bread dough in the refrigerator for 6 to 12 hours to extend the fermentation and develop the flavor in the dough.

Remove the dough from the refrigerator. Scrape it onto a lightly floured work surface. Divide into two equal pieces and shape into rough balls. Let rest, covered for about an hour, until the dough comes up to room temperature. Roll each piece of dough into a thin log shape about 12 inches long. Arrange a floured canvas or towel to form two channels. Tuck the loaves into the channels with the seam up; cover with plastic wrap and let rise for 30 to 45 minutes, until the dough increases in size by 50 percent. The dough will feel soft, but will spring back when poked with your finger.

Move the uppermost rack of the oven so that it is about 8 inches from the top of the oven and place a baking stone on the rack. Place a small cast-iron skillet to preheat on the floor or lower rack of the oven. Preheat the oven to 475°F.

Gently transfer the loaves with the seam down onto a baker's peel or the back of a baking sheet that has been dusted with cornmeal. Sprinkle the top of each loaf with flour. Use a serrated knife to cut 4 long parallel slashes along the length of each loaf at a 45° angle. Slide the loaves directly onto the preheated baking stone. Carefully pour 1 cup of warm water into the cast-iron pan on the oven floor. Reduce the heat to 450°F. Bake the loaves for 20 to 25 minutes, until the crust is golden and the loaves sound hollow when tapped on the bottom. Remove the loaves from the oven and place on a rack to cool completely before slicing or storing.

Nutritional analysis per serving:

Calories 123 (from fat 1%) • pro. 5g • carbo. 27g • fat 0g
sat. fat 0g • chol. 0mg • sod. 323mg • fiber 2g



Entrées

East-West Chicken and Vegetable Stir-Fry with Pasta

Asian flavors blend with Italian Reggiano Parmesan and pasta in this colorful and delicious stir-fry.

Makes 6 servings

Preparation: 40 - 45 minutes

- | | | | |
|-------|---|-------|---|
| 4 | 5-ounce (approximate weight) boneless, skinless chicken breast halves | 2 | broccoli stalks (about 12 ounces total), florets cut to serving size pieces, stems reserved |
| 12 | ounces dry pasta shapes such as fusilli, radiatore, penne, or double elbows | 2 | large carrots, (about 8 ounces), peeled and cut into 1-1/2-inch lengths |
| 1-1/2 | ounces Reggiano Parmesan cheese, cut in 1/2-inch cubes | 2-1/2 | teaspoons cornstarch |
| 1 | large clove garlic | 1/2 | cup chicken stock |
| 5 | slices peeled ginger, each about the thickness of a quarter | 3-1/2 | tablespoons Asian sesame oil, divided |
| 1 | red bell pepper, stem, ribs and seeds removed, cut to fit the feed tube | 3/8 | cup sherry (Amontillado or medium-dry) |
| 1/2 | yellow bell pepper, stem, ribs and seeds removed, cut to fit the feed tube | 3 | tablespoons tamari sauce (may use low sodium) or soy |
| | | 1/2 | cup slivered almonds, lightly toasted |

Trim the chicken of all visible fat. Cut in half crosswise; place on a baking sheet lined with plastic wrap and freeze for 25 minutes. Clean the work surface and wash hands thoroughly. Using a pasta cooking pot with insert, cook the pasta al dente in lightly salted water according to package instructions. Drain the pasta and set aside; keep the water simmering.

Insert the metal blade. With the machine running, drop the cheese cubes through the small feed tube and process until finely chopped, about 30 seconds. Remove and reserve. Add the garlic and ginger; process until finely chopped, about 5 seconds. Remove and reserve.

Insert the slicing disc. Use medium pressure to slice the red and yellow peppers. Place the carrots horizontally in the large feed tube. Use medium pressure to slice. Remove and reserve. Using a vegetable peeler, peel the broccoli stems, then trim to fit the small feed tube. Use medium pressure to slice. Remove and reserve.

Remove the chicken from the freezer; place in the large feed tube cut side down. Use medium pressure to slice. Toss with 1-1/2 tablespoons of the sesame oil and set aside on a plate separate from the vegetables. Clean the work surface thoroughly, and wash hands with hot soapy water. Combine the cornstarch and chicken stock in a small bowl; set aside.

Heat a large nonstick stir-fry pan over high heat. When hot enough to make water droplets dance, add the chicken and stir-fry until opaque, about 2 minutes. Remove to a clean plate and reserve. Add the remaining sesame oil to the pan. When hot, add the garlic and ginger; stir-fry 10 seconds. Add the sliced broccoli stems and carrots. Stir-fry for 45 seconds. Add the broccoli florets and sliced red bell pepper; stir-fry for another 30 seconds. Return the cooked chicken to the pan along with the soy sauce and sherry, and cook for 30 seconds. Stir in the cornstarch mixture, and bring to a boil. Return the pasta to the simmering pasta water to reheat. Drain and add to the stir-fry pan; toss to combine. Remove from the heat, add half the cheese and toss to coat with the sauce.

Transfer the stir-fry to a warmed serving bowl. Top with the remaining cheese and the toasted almonds. Serve immediately.

Nutritional analysis per serving:

Calories 570 (from fat 30%) • pro. 41g • carbo. 59 • fat 19g
sat. fat 2g • chol. 64mg • sod. 677mg • fiber 4g

Salmon and Pesto Potatoes en Papillote

Just add a simple green salad for a quick and easy dinner.

Makes 6 servings

Preparation: 10 - 15 minutes, plus 18 minutes baking time

- | | | | |
|---|---|-----|---|
| 1 | tablespoon extra virgin olive oil | 2 | pounds skinless salmon fillet,
cut into 6 equal portions |
| 6 | Yukon Gold or other new potatoes,
4 ounces each, well scrubbed,
opposite ends trimmed flat with a knife | 3/4 | teaspoon kosher salt |
| 6 | teaspoons Pesto – recipe follows | 1/2 | teaspoon freshly ground pepper |
| | | 6 | fresh basil leaves |

Preheat the oven to 400° F. Cut 6 pieces of aluminum foil, each 16 inches long.

Brush a 6 x 4-inch area in the center of each rectangle with olive oil. Set aside.

Insert the slicing disc. Slice the potatoes, one at a time. Remove each potato; restack and reserve separately.

Season each salmon fillet with salt and pepper. Fan out the slices of one potato on the oiled portion of a sheet of foil. Spread one teaspoon of the Pesto on the fanned slices. Top with a salmon fillet. Bring the two cut sides of the foil together over the center of the salmon; fold over 1 inch, then fold over 2 more times. Fold the ends in twice, in 1/2-inch folds, to complete the seal. Repeat until all the salmon and potatoes have been prepared and wrapped. Bake in the preheated oven for 22 minutes.

While the salmon is in the oven, stack the basil leaves and roll. Slice in 1/8-inch intervals to create a chiffonade. When done, the packets will be puffed. Prick with the tip of a sharp knife to vent the steam, then carefully open. Serve immediately on warmed plates sprinkled with the basil chiffonade.

Nutritional analysis per serving:

Calories 390 (from fat 46%) • pro. 32g • carbo. 21g • fat 20g
sat. fat 4g • chol. 85mg • sod. 379mg • fiber 2g

Pesto

Our Pesto is lower in fat than traditional pestos, and just as flavorful

Makes 1-1/3 cups.

Preparation: 5 - 10 minutes

- | | | | |
|---|---|--------|---|
| 2 | ounces Reggiano Parmesan,
cut in 1/2-inch pieces | 4 to 6 | tablespoons extra virgin olive oil |
| 2 | cloves garlic | 5 | tablespoons lightly toasted pine
nuts or walnuts |
| 3 | cups packed fresh basil leaves,
washed and dried | 1/4 | teaspoon salt |

Insert the metal blade. With the machine running, drop the cheese down the small feed tube and process to chop, about 10 seconds. Remove and reserve. With the machine running, drop the garlic clove down the small feed tube; process to chop, about 5 seconds. Scrape the work bowl. Add the basil to the work bowl. Pulse to chop, 20 to 30 times. Scrape the work bowl. With the machine running, add 4 tablespoons of the olive oil in a slow drizzle through the hole in the pusher; add the remaining olive oil to taste. Scrape the work bowl; add the reserved cheese, pine nuts and salt, and pulse to incorporate and chop the nuts. Transfer to a jar to store. Let rest for about 30 minutes before using, to allow the flavors to blend. Refrigerate to store, with a layer of olive oil poured over the top to prevent discoloration. Keeps 5 days in the refrigerator, or may be frozen.

Nutritional analysis per serving:

Calories 43 (82% from fat) • carbo 1g • pro 1g • fat 4g
sat. fat 1g • chol 2mg • sod 71mg • fib 0g

Shrimp & Ginger Stuffed Sole

Pleasing to the palate and to the eye, this dish is mostly do-ahead, making it perfect for entertaining.

Preparation: 30 minutes, plus 20 minutes baking and 10 minutes for the sauce

1-1/4 pounds shrimp (16-20 count), peeled and deveined	2 tablespoons unsalted butter
2 bunches tender, fresh chives	1-1/2 tablespoons low-sodium tamari or soy sauce
1/3 cup Italian parsley leaves	3/4 teaspoon freshly ground black pepper
6 green onions, trimmed to 5 inches, then cut in 1-inch lengths	1-1/2 pounds sole (six 4-ounce fillets), skinless
1 2-inch piece of fresh ginger, peeled, cut in 1/2-inch pieces	3/4 cup dry vermouth or white wine
6 ounces French bread, cut into 1-inch cubes	3/4 cup heavy cream

Cut along the vein line to within 1/2 inch of the tail to butterfly 6 of the shrimp; reserve and refrigerate. Lay the remaining shrimp in a single layer on a sheet of plastic wrap on a baking sheet and freeze for 20 minutes.

Reserve 20 of the longest, most flexible chives. Cut 16 of the remaining chives into 1-inch lengths; refrigerate any remaining chives for another use. Insert the metal blade. Pulse to chop the 16 chives. Remove and reserve. Pulse to chop the parsley, 10 times; leave in work bowl. With the machine running, drop the ginger down the small feed tube and process 10 seconds to chop. Add the green onions; pulse to chop, 10 times. Remove and reserve the parsley, ginger and green onion mixture. Process the bread until it becomes medium coarse crumbs, 1 minute. Remove and reserve. Pulse to chop the partially frozen shrimp, 20 to 30 times. There should be no piece of shrimp larger than 1/2 an inch. Remove and refrigerate.

In a 3-1/2 quart sauté pan, melt the butter over medium heat. Add the parsley, ginger and green onion mixture; cook until tender, about 2 to 3 minutes. Stir in the breadcrumbs, tamari and pepper; toss to combine and cook for 2 minutes longer. Transfer to a bowl and let cool completely. Stir in the reserved chopped shrimp and just enough water to help the mixture hold together. Lightly butter a 13 x 9 x 2-inch baking dish. Cut a sheet of waxed paper or parchment 15 inches long; lightly butter the paper.

Lay the sole fillets on the work surface, skin side up. Divide the stuffing mixture into 6 equal portions. Loosely pack each portion and place one portion in the center of each fillet. Fold the two long ends of the fillet up over the filling and overlap; turn over. Tie the cut ends of 2 chives together, using a double knot. Slip the knotted portion under the stuffed and rolled sole; bring the 2 ends together over the top and tie. Place in prepared baking dish. Repeat with the remaining sole and stuffing. The dish may be done ahead to this point, 8 hours ahead, covered with plastic wrap and refrigerated. If refrigerated, let sit at room temperature for 15 minutes before continuing. Preheat the oven to 400° F.

Add the wine to the baking dish; cover with the buttered paper, butter side down, and bake for 20 minutes. After 16 minutes, lay one of the reserved butterflied shrimp, cut side down, on each sole bundle. Re-cover and continue to bake for an additional 5 minutes. Transfer the sole to a warmed serving platter and cover loosely. Strain the cooking liquid into a 2 quart Windsor pan, and reduce by half over high heat. Add the heavy cream, and reduce by half again. To serve, nap the sauce over and around the sole, then sprinkle with the reserved chopped chives.

Nutritional analysis per serving:

Calories 444 (from fat 39%) • pro. 44g • carbo. 20g • fat 18g
sat. fat 8g • chol. 232mg • sod. 598mg • fiber 1g



Pizzas

Pesto, Cheese & Fresh Tomato Pizza

Homemade pesto and fresh, ripe tomatoes from the garden make this a great summertime pizza.

Makes two 12 - 14 inch pizzas or four 8 - 9 inch pizzas, to serve 6

Preparation: 1 hour for the pizza dough (Cuisinart recipe, p. 35);
20 minutes plus 12 minutes baking and resting time

Pizza Dough, p. 35	2	ounces Italian Fontina cheese
12 ounces firm but ripe plum tomatoes	4	tablespoons Pesto, p. 43
1/2 ounce Reggiano Parmesan, cut in 1/2-inch cubes	2	teaspoons extra virgin olive oil
3 ounces fresh mozzarella, well chilled		Cornmeal for dusting the peel or pan

Prepare the Pizza Dough and let rise. Position the top rack of the oven about 8 inches from the top. If using a baking stone, place it on the rack. Preheat the oven to 500° F.

Bring 6 cups of water to a boil in medium saucepan. Cut a shallow “x” in the bottom of each tomato. Blanch the tomatoes in the boiling water for 30 seconds, then immediately plunge them into a bowl of iced water. When cool, slip the skins off. Slice the stem end off each tomato; set aside.

Insert the metal blade. With the machine running, drop the Parmesan cheese cubes down the small feed tube; process 15 seconds and leave in bowl. Insert the shredding disc and shred the mozzarella and fontina. Remove the cheese to a bowl; toss to combine, and reserve. Insert the slicing disc. Place the tomatoes in the small feed tube one at a time, and slice, using light pressure. Place the sliced tomatoes on a triple thick layer of paper towels to drain.

When the dough has risen, punch down and divide into 2 or 4 equal balls. Let rest 10 minutes. Roll the dough out to size. Place on a baker’s peel that has been sprinkled with cornmeal. Brush the edges with the olive oil. Using an offset spatula, spread the pizza with the pesto sauce to 3/4 inch of the edges, using 3 tablespoons on each 14-inch pizza or 1-1/2 tablespoons on each 9-inch pizza. Divide the shredded cheeses evenly and sprinkle on the pizzas. Top with the drained sliced tomatoes.

Carefully slide the pizza onto the stone (position the peel over the back edge of the stone, and use a rocking motion to shake and slide the pizza off the peel onto the stone), or place the pan in the hot oven. Bake the pizza for 5 minutes, then rotate it front to back for even baking. Bake for another 3 to 6 minutes until the pizza is bubbly, and the edges of the dough are golden brown, puffed and crispy. Remove from the oven and let rest on a rack for 2 to 3 minutes before slicing.

Nutritional analysis per serving:

Calories 367 (from fat 35%) • pro 14g • carbo. 45g • fat 15g
sat. fat 6g • chol. 25mg • sod. 723mg • fiber 3g

Five Cheese Pizza Bianco

A blend of 5 cheeses, shallots, garlic and herbs makes our Pizza Bianco.

Preparation: 1 hour for the pizza dough (Cuisinart recipe, p.35);

20 minutes plus 12 minutes baking and resting time

Makes three 11 to 12-inch pizzas or six 6-inch pizzas, to serve 6

1	recipe Pizza Dough, p.35	6	ounces fresh mozzarella, well chilled
2	tablespoons fresh flat parsley leaves	3	ounces fontina, well chilled
5	large basil leaves	2	ounces Gruyère (not processed cheese food), well chilled
2-1/2	teaspoons fresh thyme leaves		
10	chives, cut in 1-inch lengths	1	ounce Gorgonzola or blue cheese, well chilled
1	shallot (2 ounce), peeled		
3/4	ounce Reggiano Parmesan, cut in 1/2-inch pieces		

Prepare the Pizza Dough and let rise. Position the top rack of the oven about 8 inches from the top. If using a baking stone, place it on the rack. Preheat the oven to 500° F while preparing the pizza.

Insert the metal blade. Process to chop the herbs, 10 seconds. Remove and reserve. With the machine running, drop the shallot and garlic down the small feed tube and process to chop, 5 seconds. Scrape the work bowl. Do not empty. With the machine running, drop the Parmesan cheese cubes down the small feed tube and process to chop finely, 10 seconds. Do not empty the work bowl. Insert the shredding disc. Use medium pressure to shred the mozzarella, fontina, Gruyère, and Gorgonzola. Transfer the cheese mixture to a large bowl and toss well to combine evenly. Keep chilled until ready to use.

When the dough has risen, punch down and divide into 3 or 6 equal balls. Let rest 10 minutes. Roll the dough out to size. Place on a baker's peel that has been sprinkled with cornmeal, or on a perforated pizza pan, a pizza screen or baking sheet without sides that has been sprinkled with cornmeal. Brush the edges with the olive oil. Divide the cheese mixture into 3 or 6 equal amounts. Sprinkle the cheese mixture evenly over the pizzas.

Carefully slide the pizza onto the stone (position the peel over the back edge of the stone, and use a rocking motion to shake and slide the pizza off the peel onto the stone), or place the pan in the hot oven. Bake the pizza for 5 minutes, then rotate it front to back for even baking. Bake for another 3 to 6 minutes, until the cheese is bubbly, and the edges of the dough are golden brown, puffed and crispy. Remove from the oven, sprinkle with the reserved chopped fresh herbs, and let rest on a rack for 3 to 4 minutes before slicing.

Nutritional Analysis Per Serving

Calories 362 (from fat 35%) • pro 16g • carbo 43g • fat 14g •
sat. fat 7g • chol. 38mg • sod. 658mg • fiber 2g

Pizza Margherita

Some of the best things in life are the simplest.

Makes three 12 - 14 inch pizzas

Preparation: 1 hour for the pizza dough (Cuisinart recipe, p. 35);
20 minutes plus 12 minutes baking and resting time

- | | | | |
|----|---------------------------------------|-------|--|
| 1 | recipe Pizza Dough, p. 35 | 1 | cup Simple Tomato Sauce, p. 49,
reduced version for pizza |
| 9 | ounces fresh mozzarella, well chilled | 1-1/2 | tablespoons extra virgin olive oil |
| 27 | fresh basil leaves, washed and dried | | |

Prepare the Pizza Dough and let rise. Position the top rack of the oven about 8 inches from the top. If using a baking stone, place it on the rack. Preheat the oven to 500° F.

Insert the shredding disc. Use medium pressure to shred the mozzarella. Remove and reserve. Stack 12 basil leaves; roll, then use a knife to thinly slice. Repeat with the remaining leaves. This is called a chiffonade. Reserve.

When the dough has risen, punch down and divide into 2 or 4 equal balls. Let rest 10 minutes. Roll the dough out to size. Place on a baker's peel that has been sprinkled with cornmeal, or on a perforated pizza pan, a pizza screen or baking sheet without sides that has been sprinkled with cornmeal. Brush edges with the olive oil. Using an offset spatula, spread 1/3 cup of the reduced Simple Tomato Sauce evenly over each 12-inch pizza, or spread 2-1/2 tablespoons of the sauce on each 6-inch pizza. Sprinkle each pizza with one quarter of the basil chiffonade, then sprinkle each pizza evenly with one half of the shredded mozzarella.

Carefully slide the pizza onto the stone (position the peel over the back edge of the stone, and use a rocking motion to shake and slide the pizza off the peel onto the stone), or place the pan into the hot oven. Bake the pizza for 5 minutes, then rotate it front to back for even baking. Bake for another 3 to 6 minutes, until the pizza is bubbly, and the edges of the dough are golden brown, puffed and crispy. Remove from the oven, sprinkle with the remaining fresh basil chiffonade, and let rest on a rack for 2 to 3 minutes before slicing.

Nutritional analysis per serving:

Calories 313 (from fat 28%) • pro 12g • carbo 44g • fat 9g
sat. fat 4g • chol. 22mg • sod. 727mg • fiber 2g

Roasted Pepper, Chevre & Mozzarella Calzone

Make ahead for a picnic or tailgating party.

Makes 4 large or 8 small calzones, 8 servings

Preparation: 1 hour for the pizza dough (Cuisinart recipe, p. 35);
25 minutes plus about 30 minutes baking and resting time

2-1/2	red bell peppers, cut in half, cored and seeded	6	large fresh basil leaves, washed and dried
1-1/2	yellow bell peppers, cut in half, cored and seeded	1	ounce Reggiano Parmesan, cut in 1/2 - inch cubes
1	teaspoon extra virgin olive oil	8	ounces fresh mozzarella, well chilled
2-1/2	teaspoons balsamic vinegar		
1	recipe Pizza Dough, p. 35	8	ounces chevre or goat cheese
3	tablespoons flat parsley leaves, washed and dried	2	ounces Ricotta Salata, crumbled Cornmeal for sprinkling

Preheat the oven to 400° F. Line a shallow baking sheet with foil. Insert the slicing disc. Use medium pressure to slice the red and yellow peppers. Remove and toss with the olive oil. Spread in a single layer on the baking sheet. Roast for 20 to 25 minutes, until tender and beginning to brown. Transfer to a small bowl; toss with the balsamic vinegar and let cool.

Prepare the Pizza Dough and let rise. Position the rack in the middle of the oven. If using a baking stone, place it on the rack. Raise the oven temperature to 450° F. Sprinkle a nonstick baking sheet (not "air-bake" type) or baker's peel with cornmeal.

Insert the metal blade. Pulse to chop the parsley and basil, 10 times. Remove and reserve. With the machine running, drop the Parmesan cubes down the small feed tube and process to chop, 10 seconds. Insert the shredding disc and shred the mozzarella. Leave in the work bowl. Insert the metal blade. Sprinkle the crumbled chevre, Ricotta Salata and reserved herbs over the mozzarella. Pulse to combine, 12 to 15 times. Remove and refrigerate until ready to assemble the calzones.

Divide the dough into 4 or 8 equal balls depending on size of calzones desired. Cover loosely with plastic wrap and let rest for 10 minutes. Lightly flour the work surface. Roll into rounds, 9 - 10 inches each in diameter for 4 balls, and 5 - 6 inches in diameter for 8 balls. Spread the cheese mixture over half the dough, leaving a 1-inch border. Use 1/2 cup for the larger calzones and 1/4 cup for the smaller calzones. Drain the peppers. Sprinkle the peppers over the cheese mixture - 1/4 cup for the larger calzones, 2 tablespoons for the smaller calzones.

Brush the border of the dough lightly with water. Fold the dough over the filling and press firmly to seal the edges. Then make overlapping folds around the edges of the calzone. Use a serrated knife to make three 1-inch slashes on the top of each calzone for the steam to escape. Place on a cornmeal-dusted baker's peel and slide onto the preheated baking stone, or onto a cornmeal-dusted baking sheet. Bake for 20 to 25 minutes, until the dough is baked through and is a deep golden brown. Transfer to a rack to cool for 10 minutes before serving. Calzones may be served hot or at room temperature. Leftover calzones should be wrapped in foil or plastic wrap and refrigerated. Re-warm in a 375° F oven before serving. Microwaving is not recommended.

Nutritional analysis per serving:

Calories 244 (from fat 57%) • pro 15g • carbo 12g • fat 16g
sat. fat 10g • chol. 41mg • sod 318mg • fiber 2g



Sauces & Dressings

Simple Tomato Sauce

*A simple marinara sauce for pasta,
or when reduced, a tasty topping for homemade pizzas.*

Makes 3 cups tomato sauce for pasta / 1-3/4 cups tomato sauce for pizza

Preparation: 5-10 minutes plus 1 hour cooking and cooling time
(add an additional 40-50 minutes to make the reduced pizza sauce)

- | | | | |
|-----|---|----------|--|
| 1 | small onion (4 ounces),
cut in 1-inch pieces | 3 | tablespoons dry white wine or
vermouth |
| 4 | cloves garlic, peeled | 1/2 | teaspoon kosher salt |
| 3/4 | teaspoon dried oregano | 1/4 | teaspoon freshly ground black
pepper |
| 1 | teaspoon extra virgin olive oil | 1/4 -3/4 | teaspoon crushed red pepper flakes
(optional, to taste, for a spicier
sauce) |
| 1 | can (28 ounce) plum tomatoes,
with juices | | |
| 2 | sprigs fresh basil (10-12 large
leaves) | | |

Insert the metal blade. Pulse to chop the onion and garlic with the oregano, about 10 times. Heat the oil over medium heat in a 2-3/4-quart saucepan; add the onion, garlic, and oregano. Cook, stirring for 2 to 3 minutes, until the onions begin to soften and the oregano becomes fragrant. Add the canned tomatoes with their juices, basil sprigs, wine and salt. Bring to a boil, then reduce the heat to low, cover loosely and simmer for 45 to 50 minutes. Turn off the heat and let cool in the pan for 10 minutes. Stir in the black pepper and red pepper flakes if using.

Using the metal blade, pulse the sauce 15 times for a rustic, chunky sauce, or process for 2 minutes for a smooth sauce. The sauce is now ready to use for pasta. If you want a sauce for pizza, return the sauce to the pan. Simmer, uncovered, for 40 to 50 minutes to reduce, stirring now and then. Transfer the reduced sauce to a bowl to cool before using as a pizza topping. The sauce freezes well.

Nutritional analysis per half cup tomato sauce:

Calories 47 (20% from fat) • carbo. 6g • pro. 2g • fat 1g
sat. fat 0g • chol. 0mg • sod. 519mg • fiber 1g

Nutritional analysis per quarter cup reduced for pizza sauce:

Calories 40 (20% from fat) • carbo. 6g • pro. 2g • fat 1g
sat. fat 0g • chol. 0mg • sod. 445mg • fiber 2g

Cranberry Relish with Toasted Walnuts

Fast and fresh, delicious with roast turkey, chicken, pork or ham

Makes 3 cups

Preparation: 5 - 10 minutes, plus 10 minutes to toast the walnuts

3/4	cup walnut halves, shells removed	3	cups fresh or frozen cranberries (do not thaw if using frozen berries)
3/4	cup sugar		
8	strips orange zest, bitter white pith removed	3/4	navel orange, peeled, cut into quarters

Preheat oven to 350° F. Place walnuts in a baking pan and toast until golden brown and fragrant, about 8 to 10 minutes. Cool slightly.

Insert metal blade. Process sugar and zest until finely chopped, about 45 seconds. Add cranberries, orange and reserved nuts; pulse until coarsely chopped, about 10 to 12 times. Pulse several more times if a finer consistency is desired.

This relish may be made in advance and stored in the refrigerator until ready to use.

Nutritional analysis per 2 tablespoons:

Calories 58 (31% from fat) • carbo. 9g • pro. 1g • fat 2g
sat. fat 0g • chol. 0mg • sod. 0mg

Creamy Chevre & Peppercorn Dressing

Creamy and tangy, perfect for crisp romaine.

Makes 1-3/4 cups (28 tablespoons)

Preparation: 10 minutes, plus 30 minutes resting time

1-1/2	ounces shallots, peeled and trimmed	1-1/2	tablespoons water
1	tablespoon drained green pepper- corns, rinsed & drained again	1/3	cup lowfat sour cream
1-1/2	tablespoons freshly squeezed lemon juice	6	ounces chevre
1-1/2	tablespoons white wine vinegar	1/3	cup extra virgin olive oil

Insert the metal blade. With the machine running, drop the shallots down the small feed tube; process 5 seconds to chop. Add the drained green peppercorns; chop 10 seconds. Remove and reserve. Process the chevre, sour cream, lemon juice, white wine vinegar and water until smooth, 30 seconds. Scrape the work bowl. Return the shallot and peppercorn mixture to the work bowl; add the salt. With the machine running, add the olive oil through the hole in the small pusher, processing until completely incorporated and emulsified. Let sit for 30 minutes before using, to allow the flavors to blend. The dressing will keep for a week in the refrigerator.

Nutritional analysis per tablespoon:

Calories 47 (81% from fat) • carbo. 1g • pro. 1g • fat 4g
sat. fat 1g • chol. 3mg • sod. 22mg • fiber 0g

Herbed Balsamic Vinaigrette

Drizzle over sliced summer tomatoes for a quick and easy salad.

Preparation: 10 minutes, plus 30 minutes resting time

- | | | | |
|-----|---|-----|--------------------------------------|
| 1 | large clove garlic | 1/2 | teaspoon freshly ground black pepper |
| 1/4 | cup fresh Italian parsley leaves,
washed and dried | 2 | teaspoons Dijon-style mustard |
| 1 | tablespoon dried basil | 6 | tablespoons balsamic vinegar |
| 1 | teaspoon dried oregano | 2/3 | cup extra virgin olive oil |
| 1/2 | teaspoon kosher or sea salt | | |

Insert the metal blade. With the machine running, drop the garlic down the small feed tube; process 5 seconds to chop. Add the fresh parsley, dried basil and oregano, salt, pepper, mustard and vinegar; process 10 seconds to blend. With the machine running, add the olive oil one third cup at a time through the hole in the small feed tube pusher. Process 1 minute longer until totally emulsified.

Adjust seasonings to taste. Allow the dressing to rest for 30 minutes before using, to allow the flavors to blend. Refrigerate unused portions – bring to room temperature (30 minutes) before using, and reprocess to emulsify, using the metal blade if necessary.

Variation: For an Herbed Vinaigrette, use red or white wine vinegar.

Nutritional analysis per tablespoon:

Calories 81 (95% from fat) • carbo 1g • pro 1g • fat 8g
sat. fat 1g • chol 0mg • sod 67mg • fiber 0g

Basic Mayonnaise

The American Egg Board recommends using the freshest eggs and then heating them to kill salmonella bacteria.

This recipe uses a procedure suggested by cookbook author and food sleuth Shirley Corriher for heating the eggs to sanitize them.

The results are definitely worth the effort.

Proper refrigeration and storage are necessary.

Makes 1-3/4 cups

Preparation: 15 - 20 minutes

1	large egg	1/2	teaspoon flour
1	large egg yolk	2-1/2	teaspoons dry mustard
1	tablespoon freshly squeezed lemon juice	1	teaspoon kosher salt
1	tablespoon wine vinegar		pinch of cayenne
1-1/2	tablespoons water	2	tablespoons extra virgin olive oil
1/2	teaspoon sugar	1-1/3	cups vegetable oil (canola, soya, etc.)

Insert the metal blade. Process the egg, egg yolk, lemon juice, wine vinegar, water, sugar and flour until smooth, about 20 seconds. Transfer the egg mixture to a small (7 or 8-inch) nonstick skillet, and heat over very low heat while gently stirring and scraping the bottom of the pan with a spatula. When the mixture begins to thicken and resemble a custard sauce, remove from the heat while still stirring and set in a pan of ice and water to stop the cooking. Stir until the egg mixture has cooled; let rest for 5 minutes. Wash the work bowl, metal blade and lid in hot soapy water and dry thoroughly.

Insert the metal blade. Process the cooled egg mixture with the dry mustard, kosher salt, and cayenne until blended, 1 minute. Scrape the work bowl. With the machine running, add the olive oil through the hole in the small feed tube very slowly. Scrape the work bowl. With the machine running, add the vegetable oil through the hole in the small pusher, one quarter cup at a time, and allow the oil to drip through the hole slowly into the emulsion. The mayonnaise will thicken as the oil is added. Taste and adjust seasonings as necessary. Remove to a container, cover and keep refrigerated. Keeps 3 to 4 days refrigerated.

Nutritional analysis per tablespoon:

Calories 108 (98% from fat) • carbo. 0g • pro. 0g • fat 12g
sat. fat 1g • chol. 15mg • sod. 70mg • fiber 0g

Tzatziki Sauce

Low in fat yet full of flavor, this sauce is great as a sandwich spread, or as a dipping sauce for crudités.

Makes 3 cups / 48 tablespoons

Preparation: 10 minutes (plus 12 hours or overnight to drain yogurt),
30 minutes resting time

- | | | | |
|---|--|-------|---|
| 3 | cups nonfat plain yogurt,
drained overnight to yield 1-1/2 cups* | 1-1/4 | teaspoons kosher salt |
| | | 1/3 | cup fresh flat parsley leaves |
| 2 | cucumbers, 7 inches in length, peeled,
halved, seeded and cut into 1-inch
pieces, set over a strainer to drain for
30 minutes | 1/3 | cup fresh mint leaves |
| | | 1-1/2 | tablespoons fresh oregano leaves
(or 3/4 tablespoon dried) |
| 4 | cloves garlic | 2 | teaspoons fresh marjoram leaves
(or 1 teaspoon dried) |

Insert the metal blade. With the machine running, drop the garlic down the small feed tube; process 5 seconds to chop. Add the kosher salt, parsley, mint, oregano, and marjoram; pulse to chop, 15 to 20 times. Add the drained cucumber pieces; pulse to chop, 15 to 20 times. Add the drained yogurt; pulse to combine. Do not overprocess, or the sauce will become runny. Allow the sauce to sit for 30 minutes for the flavors to blend. Refrigerate until ready to use. Keeps 3 to 4 days in the refrigerator; do not freeze.

* To drain yogurt: Line a sieve with a double layer of cheese cloth or a paper coffee filter and set over a bowl. Spoon yogurt into lined sieve, cover with plastic wrap and refrigerate overnight (8 hours minimum). You may need to drain water from the bowl occasionally. Refrigerate thickened yogurt in an airtight container for up to one week.

Nutritional analysis per serving:

Calories 9 (3% from fat) • carbo 1g • pro 1g • fat 0g
sat. fat 0g • chol 0mg • sod 60mg • fiber 0g



French Cut Green Beans with Shallots

The time-consuming "french cut" takes just seconds with a Cuisinart food processor.

Makes 6 servings

Preparation: 15 - 20 minutes

- | | |
|--|------------------------------------|
| 1-1/2 pounds fresh green beans, trimmed, cut to fit feed tube horizontally | 6 tablespoons water |
| 3 large shallots, peeled, cut into 1-inch pieces | 2-1/4 teaspoons balsamic vinegar * |
| 1-1/2 tablespoons olive oil | 1/4 teaspoon white pepper |
| | 1/4 teaspoon salt |

Insert the slicing disc. Place beans horizontally in large feed tube and process, using light pressure. Remove and reserve.

Insert metal blade. Process shallots until finely chopped, about 5 seconds.

Warm oil in a 3-1/2 quart sauté pan over medium heat. Add chopped shallots and sauté until soft but not browned, about 2 minutes. Add green beans and sauté for 3 to 4 minutes. Add water and reduce heat to low. Cover pan and cook until crisp tender, about 8 to 10 minutes. Remove from heat and add vinegar. Season with pepper and salt. Serve warm.

* Substitute a fruit flavored vinegar for a change of flavor.

Nutritional analysis per serving:

Calories 80 (45% from fat) • carbo. 9g • pro. 2g • fat 4g
sat. fat 0g • chol. 0mg • sod 81 mg • fiber 0g

Asian Slaw with Peanut Dressing

Add cooked pasta and turn this salad into a meal.

Makes 1 cup dressing.

Makes eight 1-cup servings of pasta salad.

Preparation: 10 minutes plus 30 minutes resting time for the dressing;
10 - 15 minutes for the vegetables

1/2	cup toasted unsalted peanuts	1	broccoli spear, washed, florets trimmed and reserved, stem peeled
2	cloves garlic		
6	slices of fresh ginger, peeled, each about the size of a quarter	3	green onions, trimmed, cut to 4-inch lengths, including tasty green tops
4	tablespoons natural style peanut butter	1	red bell pepper, stemmed, seeded and cut into 1-1/2 x 3-inch pieces
1/3	cup + 1 tablespoon rice vinegar	1	yellow bell pepper, stemmed, seeded and cut into 1-1/2 x 3-inch pieces
3	teaspoons sugar	8	ounces Napa cabbage, washed and cut into 3-inch lengths to fit feed tube
2	tablespoons + 1 teaspoon hoisin sauce	6	ounces bok choy, washed and cut to fit feed tube
2	teaspoons sesame oil		(include leaves if pretty & tender)
2	teaspoons low-sodium tamari or soy sauce	4	ounces snow peas, trimmed and strings removed
2-1/2	tablespoons vegetable oil		
4	ounces carrots, peeled and trimmed to fit the feed tube horizontally		
4	ounces red radishes, washed, ends cut flat		

Insert the metal blade. Pulse to chop the peanuts, about 10 times. Remove and reserve. With the machine running, drop the garlic and ginger down the small feed tube to chop, about 5 seconds. Scrape the work bowl; process 5 seconds longer. Add the peanut butter, sugar, rice vinegar, hoisin sauce, sesame oil, and tamari. Process until smooth, about 10 seconds. Scrape the work bowl. With the machine running, add the vegetable oil in a steady stream through the small feed tube. Process until emulsified, about 10 to 15 seconds. Remove and reserve. The dressing may be made up to several days ahead. Cover well and refrigerate. Allow to sit for 30 minutes at room temperature before using.

Clean the work bowl. Insert the shredding disc. Arrange the radishes in the large feed tube, cut side down, and shred. Arrange the carrots horizontally in the large feed tube and shred. Insert the trimmed and peeled broccoli stem in the small feed tube and shred. Transfer the shredded vegetables to a large bowl.

Insert the slicing disc. Arrange the green onions in the small feed tube and slice. Arrange the peppers in the large feed tube, cut side down, and slice. Arrange the Napa cabbage in the feed tube, cut side down, and slice. Arrange the bok choy in the feed tube and slice. Transfer the sliced vegetables to the bowl with the other vegetables. Add the broccoli florets and snow peas; toss the vegetables to combine. Pour the dressing over the vegetables and toss to coat well. Transfer to a serving bowl and garnish with the reserved chopped peanuts.

Note: You may turn this into an Asian pasta salad by doubling the dressing ingredients and adding cooked pasta (8 ounces dry, cooked according to package directions).

Nutritional analysis per serving:

Calories 212 (60% from fat) • carbo 15g • pro 7g • fat 15g
sat. fat 2g • chol 1mg • sod 171g • fiber 4g

Roasted Garlic and Parmesan Twice Baked Potatoes

Do these potatoes ahead to serve with grilled fillets or London Broil.

Makes 6 servings

Preparation: 15 - 20 minutes, plus 1 hour to prebake the potatoes, and 25 minutes to twice bake

8	garlic cloves, peeled	3	scallions, trimmed, cut into 1-inch pieces
	Olive oil		
6	large baking potatoes (about 8 ounces each), washed, dried, pierced with a knife	3/4	cup evaporated skim milk
		3	tablespoons unsalted butter, cut into 1-inch pieces
3	ounces Parmesan cheese, cut into 1-inch pieces	1/4	teaspoon ground white pepper
		1/4	teaspoon salt

Preheat oven to 400° F. Place garlic cloves in a small ovenproof ramekin and drizzle with olive oil. Cover with aluminum foil. Lightly brush potatoes with olive oil. Place garlic and potatoes in preheated oven; roast garlic for 30 to 40 minutes and bake potatoes until fork tender, about 1 hour. When potatoes are cool enough to handle, cut off part of top and scoop out flesh, leaving a 1/4" thick shell. Reserve flesh and skins.

Insert metal blade. With machine running, drop cheese through small feed tube and process until finely grated, about 30 seconds; remove and reserve. Place scallions in work bowl and process until finely chopped, about 5 to 10 seconds. Scrape work bowl. Add milk, butter, reserved cheese, reserved garlic, pepper and salt. Process until combined, about 12 seconds. Add potato flesh; pulse in very short quick pulses until just combined, about 10 to 12 times. Scrape bowl and pulse in very short quick pulses, about 10 more times. Generously fill skins with potato-garlic mixture. Potatoes may be made ahead to this point and refrigerated until ready to bake.

Preheat oven to 350° F. Place potatoes in a 10-inch round baking pan and bake, uncovered, until tops are golden brown and potatoes are hot, about 20 to 25 minutes.

Nutritional analysis per serving:

Calories 322 (28% from fat) • carbo. 46g • pro. 12g • fat 10g
sat. fat 6g • chol. 23mg • sod. 425mg • fiber 4g

Savory Sweet Potatoes with Onions & Currants

A lowfat alternative to traditional, rich sweet potato casseroles.

Makes 8 servings

Preparation: 15 - 20 minutes, plus 85 minutes baking and resting

Cooking spray	Zest of 1/2 orange, removed with a vegetable peeler, bitter white pith shaved off
2 ounces fresh white or wheat bread	1/3 cup freshly squeezed orange juice
1 tablespoon unsalted butter, at room temperature	1/3 cup maple syrup (do not use pancake syrup!)
3 pounds sweet potatoes, peeled, ends cut flat	1-1/2 teaspoons herbs de Provence
1 pound yellow onions, peeled and cut in half lengthwise	1/2 teaspoon kosher salt
1/2 cup currants	1/2 teaspoon freshly ground pepper
	2-1/2 tablespoons unsalted butter, at room temperature

Preheat the oven to 350°F. Spray a 3-quart baking dish with cooking spray. Set aside.

Insert the metal blade. Process the bread until it becomes coarse crumbs, 15 to 20 seconds. With the machine running, drop the butter down the small feed tube and process 10 seconds to blend with the crumbs. Remove and reserve.

Insert the slicing disc. Arrange the sweet potatoes in the feed tube cut side down and slice. Remove and reserve. Slice onions; remove and reserve. Wipe the work bowl dry with a paper towel. Insert the metal blade. Use the pulse to chop the orange zest, about 15 to 20 times. Scrape the work bowl. Add the orange juice, maple syrup, herbs de Provence, salt, pepper, and unsalted butter. Process to combine, 5 seconds.

Arrange one third of the sliced sweet potatoes in a layer in the prepared pan. Top with half the onions and half the currants. Make another layer of the sweet potatoes, then top with onions and currants, and end with a layer of the remaining sweet potatoes. Drizzle the orange juice mixture evenly over the entire casserole. Cover loosely with a sheet of foil that has been sprayed with vegetable oil cooking spray. Bake in the preheated oven for 65 to 75 minutes, until the potatoes are tender. Remove the foil, top with the reserved breadcrumb mixture and bake 10 minutes longer. Let rest 10 minutes before serving.

Nutritional analysis per serving:

Calories 356 (15% from fat) • carbo 74g • pro 4g • fat 6g
sat. fat 1g • chol 13mg • sod 170mg • fiber 10g



Desserts

Hazelnut Butter Cookies

Melt in your mouth delicious – keep this cookie dough on hand in the freezer to bake when unexpected guests drop in.

Makes about 80 cookies

Preparation: 15 - 20 minutes, plus 40 minutes chilling time and 25 minutes baking and cooling time

1-3/4 cups + 2 tablespoons all-purpose flour	3/4 pound unsalted butter, at room temperature
1-1/4 cups (6 ounces) lightly toasted hazelnuts	1 cup + 2 tablespoons powdered sugar
3/8 teaspoon salt	1-1/2 tablespoons vanilla

Insert the metal blade. Process the flour, hazelnuts, and salt, using the pulse, 20 times. Remove and reserve.

Process the butter, powdered sugar and vanilla until smooth and creamy. Add the reserved flour mixture and process until the dry ingredients are just incorporated. Turn out onto a lightly floured surface and shape into 2 equal balls. Refrigerate for about 30 minutes, until stiff enough to shape into logs. Shape into logs 10 inches long and 1-1/4 inches in diameter. Wrap well in plastic wrap, and refrigerate until firm, or double wrap and freeze.

When ready to bake, preheat the oven to 350°F. Slice 1/4 inch thick and place 2 inches apart on ungreased baking sheets. (For ease in slicing, let frozen logs sit at room temperature for 10 minutes.) Bake in the preheated oven for 8 to 12 minutes, until the edges just begin to turn brown. Let cool on the baking sheets for 1 minute, then transfer to a rack to cool completely.

Nutritional analysis per cookie:

Calories 33 (44% from fat) • carbo. 4g • pro 1g
sat 2g • sat. fat 1g • chol. 1g • sod 4mg • fiber 1g

Double Chocolate Chunk Cookies

Chocolate heaven!

Makes 36 cookies

Preparation: 15 - 20 minutes, plus 20 - 25 minutes baking and cooling

5	ounces milk chocolate, chilled, broken into 1-inch pieces	1/4	teaspoon salt
5	ounces white chocolate, chilled, broken into 1-inch pieces	1	large egg
1-1/3	cups less 1 tablespoon all-purpose unbleached flour	1/2	cup firmly packed light brown sugar
1/2	cup pecan halves, shells removed	1/2	cup sugar
1/2	teaspoon baking soda	2	tablespoons reduced fat milk
		6	tablespoons unsalted butter, softened
		1	teaspoon vanilla extract

Preheat oven to 375° F.

Insert metal blade and add chocolates. Use quick pulses to coarsely chop, about 10 to 12 times. Remove and reserve. Add flour, pecans, soda and salt; process to combine, about 5 seconds. Remove and reserve.

Process egg, sugars and milk for 1 minute. Scrape work bowl. Add butter and vanilla; process for 1 minute. Scrape work bowl. Add reserved chocolate and dry ingredients. Pulse until combined, about 5 times.

Drop by rounded tablespoons, about 1 inch apart, onto ungreased baking sheets. Bake until golden brown, about 10 to 12 minutes. Allow to cool on baking sheet for 10 minutes, then transfer to a wire rack to finish cooling.

Nutritional analysis per cookie:

Calories 101 (53% from fat) • carbo 10g • pro 1g • fat 6g
sat. fat 1g • chol 12mg • sod 38mg • fiber 0g

Lemon Ginger Biscotti

Delicious with coffee or tea

Makes about 60

Preparation: 15 - 20 minutes, plus 40 minutes chilling time and
25 minutes baking and cooling time

3	ounces white chocolate, such as Lindt or Callebaut, broken up, chilled	3/4	cup sugar
2	ounces crystallized ginger	1/2	cup (1 stick) unsalted butter, at room temperature
2-1/2	cups all-purpose flour	2	large eggs
2	teaspoons baking powder	1	tablespoon brandy
1/4	teaspoon salt	1	tablespoon vanilla
Zest of 3 lemons, bitter white pith removed			

Preheat the oven to 325°F. Insert the metal blade. Pulse to chop the white chocolate, about 5 to 10 times. There should be no piece larger than 1/2 inch. Remove and reserve. Pulse to chop the crystallized ginger, 10 to 15 times. There should be no piece larger than 1/2 inch. Remove and reserve.

Pulse the flour, baking powder and salt to quick sift, 5 short pulses. Remove and reserve. Process the zest with 1/4 cup of the sugar until finely chopped, about 20 to 30 seconds. Add the remaining sugar and the butter; process until smooth. The mixture may look curdled; do not worry. With the machine running, add the eggs one at a time. Add the brandy and vanilla. Scrape the work bowl. Add the flour mixture, chopped white chocolate and chopped ginger. Process to incorporate, about 10 seconds. Turn out onto a lightly floured surface and gather into a ball. Divide into 3 equal portions. Shape into flat logs, about 12 inches long and 1-1/2 inches wide. Arrange on ungreased baking sheets and bake in a preheated 325°F oven for about 22 minutes.

Remove from the oven and let cool on the baking sheets for 10 minutes. Using a serrated knife, slice the logs at 1/2-inch intervals. Arrange slices on the baking sheet, so that the cut sides are exposed. Return to the oven and bake for another 20 to 25 minutes, until the biscotti are just beginning to turn golden and crispy. Allow to cool completely to finish the drying process. Store in an airtight container. If desired, baked and cooled Lemon Ginger Biscotti may be drizzled with melted white or bittersweet chocolate.

Nutritional analysis per Biscotti:

Calories 48 (46% from fat) • carbo 6g • pro 1g • fat 2g
sat. fat 1g • chol 11mg • sod 21g • fiber 1g

Basic Cheesecake

Creamy, smooth and simple to prepare.

“Chocoholics” will love the Double Chocolate variation.

Makes 12 servings

Preparation: 10 - 15 minutes, plus 1-1/2 hours baking and cooling time

4	lowfat honey graham cracker sheets, broken into 1-inch pieces	1	cup sugar
		1-1/2	tablespoons vanilla
1-1/2	tablespoons sugar	4	large eggs, at room temperature
1-1/2	tablespoons unsalted butter		
2	pounds lowfat cream cheese, at room temperature		

Preheat the oven to 325°F.

Wrap the bottom and sides of an 8 x 3-inch springform or cheesecake pan in a sheet of oversized heavy-duty aluminum foil. There should be no seams in the foil, and it should come up to the top of the pan. Cut off any excess. Insert the metal blade. Process the graham crackers until they are fine crumbs; add the sugar and the butter through the small feed tube and process until the butter can no longer be seen. Press into the bottom of the prepared pan. Put in the freezer until ready to fill.

Wipe out the work bowl with a paper towel. Insert the Dough Blade. Process the cream cheese until smooth on Dough Speed, about 45 seconds. Scrape the work bowl. Add the sugar and vanilla; process until smooth, about 30 seconds. Scrape the work bowl. With the machine running, add the eggs, one at a time, processing for 10 seconds after each addition. Scrape the bottom and sides of the work bowl after adding the second egg, and then after adding the last egg. Do not overprocess.

Carefully pour the cream cheese mixture into the prepared pan. Place in a roasting pan, and set on the rack of the oven. Carefully add hot water to the roasting pan until it reaches halfway up the sides of the springform pan. This is called a bain marie or water bath. Bake the cheesecake in the preheated oven for 70 minutes. The cheesecake will still look jiggly in the center. Do not worry.

Remove the cheesecake from the bain marie; remove the foil and place cake on a rack. Cool completely on rack, then cover and refrigerate for at least 8 hours.

The cheesecake is best made a day ahead. If desired, garnish with fresh fruit.

Double Chocolate Variation:

Before making the cheesecake, chop 7 ounces of good quality bittersweet or semisweet chocolate (that has been broken up) and, using the metal blade and the pulse, pulse 20 to 30 times until roughly chopped and the chunks are not bigger than 1/2 inch. Melt 4 ounces of the chopped chocolate in a double boiler set over barely simmering water; reserve the rest. Prepare the cheesecake batter, and pour 2-2/3 cups into a bowl. Cover and refrigerate. Add the melted chocolate to the batter in the work bowl and process just to incorporate. Pour into the prepared pan and freeze until just firm, 2 to 3 hours. Stir the remaining chocolate chunks into the reserved batter. Pour over the frozen chocolate layer. Bake as instructed, but increase the baking time to 85 minutes.

Nutritional analysis per serving:

Basic:

Calories 278 (50% from fat) • carbo 36g • pro 10g • fat 21g
sat. fat 9g • chol 66mg • sod 467 • fiber 1g

Chocolate variation:

Calories 360 (50% from fat) • carbo 36g • pro 10g • fat 21g
sat. fat 8g • chol 66mg • sod 467 • fiber 1g

Carrot Cake

Wonderful as a 2-layer cake, but try it as a single layer cake, freezing the second layer for another time.

Makes 12 servings

Preparation: 20 - 25 minutes, plus 2 hours baking and cooling and 45 to 50 minutes for preparing the frosting and assembling and chilling the cake

Vegetable oil cooking spray	3	large eggs
1-1/4 pounds carrots, peeled	2-1/2	tablespoons vanilla
2-1/2 cups all-purpose flour	1-1/4	cups pecans or walnuts, lightly toasted
1-1/4 teaspoons baking powder	3/4	cup golden raisins
3/8 teaspoon baking soda	1-1/4	cups well-drained pineapple chunks (juice packed)
1/4 teaspoon salt	1/3	cup coconut
1-1/4 teaspoons cinnamon	1-1/4	pounds lowfat cream cheese
1 teaspoon ginger	6	ounces white chocolate, such as Lindt or Callebaut – not imitation white coating
1/2 teaspoon freshly grated nutmeg	16	toasted pecan or walnut halves
1-1/4 cups brown sugar		
1/3 cup vegetable oil		

Preheat the oven to 350° F. Spray two 9 x 2-inch round cake pans (8 cups each) with vegetable oil cooking spray; line the bottoms with rounds of waxed paper or parchment paper and spray again. Set aside.

Insert the slicing disc; slice half the carrots. Steam until tender, about 6 to 8 minutes. Set aside to cool. Insert the shredding disc. Shred the remaining carrots; remove and reserve.

Insert the metal blade. Pulse the flour, baking powder, baking soda, salt, cinnamon, ginger and nutmeg to quick sift. Remove and reserve. Process the steamed carrots until puréed, 10 to 15 seconds. Add the brown sugar and oil; process until smooth, 10 seconds. Add the eggs one at a time, processing 10 seconds after each addition. Add the vanilla. Add the flour mixture; pulse to incorporate, about 10 times. Add the pecans; pulse to incorporate, 5 times. Add the raisins, pineapple, and coconut; pulse to incorporate, 10 times.

Divide the batter evenly between the two prepared pans. Bake in the preheated oven for 55 to 60 minutes, until a cake tester comes out clean when inserted in the center. Cool in the pans for 10 minutes, then invert onto a wire cooling rack and remove the waxed or parchment paper. Cool completely before frosting. This cake is actually better when made a day ahead. The layers may also be well wrapped and frozen. Frost with the White Chocolate Cream Cheese Frosting and garnish with toasted nuts.

White Chocolate Cream Cheese Frosting:

Insert the metal blade. Process the cream cheese until smooth. In a double boiler over hot water, carefully melt the white chocolate – do not stir, or the chocolate will seize. With the machine running, pour the melted chocolate down the feed tube and process until smooth. This will make enough frosting to frost the layers and sides of the carrot cake. For ease, use an offset spatula to frost the cake. Refrigerate before serving.

Nutritional analysis per serving:

Calories 610 (48% from fat) • carbo 71g • pro 12g • fat 34g
sat. fat 7g • chol 70mg • sod 448mg • fiber 3g

Basic Flaky Pastry Dough

This recipe makes ample crust for a 9 to 11 inch regular or deep-dish pie or tart. Leftover pastry may be rolled out and cut into shapes to garnish the pie, or brushed with milk, sprinkled with sugar or cinnamon and sugar, and baked until lightly browned.

Preparation: 10 minutes, plus 30 minutes resting time

For a one-crust pie:	8	tablespoons unsalted butter, cut in 1/2-inch pieces, well chilled
1-1/2 cups all-purpose flour		
1/4 teaspoon salt	2	tablespoons shortening (Crisco), cut in 1/2-inch pieces, well chilled
1/8 teaspoon baking powder	2 to 4	tablespoons ice water
For a two-crust pie:	16	tablespoons unsalted butter, cut in 1/2-inch pieces, well chilled
3 cups all-purpose flour		
1/2 teaspoon salt	2	tablespoons shortening (Crisco), cut in 1/2-inch pieces, well chilled
1/4 teaspoon baking powder	5 to 8	tablespoons ice water

Insert the metal blade. Process the flour, salt and baking powder to sift, 10 seconds. Add the well chilled butter and shortening. Use short rapid pulses until the mixture resembles coarse corn meal and no pieces of butter larger than a "pea" remain visible, 15 to 20 pulses. Sprinkle half the maximum ice water on the flour and butter mixture, then pulse 5 or 6 times. The dough will be crumbly, but should begin to hold together when a small amount is picked up and pressed together. Sprinkle on more water, a teaspoon (two for the two-crust recipe) at a time, with 2 to 3 quick pulses after each addition, adding just enough water for the dough to hold together easily when pressed into a ball. (Do not allow the dough to form a ball in the processor!) Add the liquid sparingly so that the dough is not sticky. Do not overprocess or the pastry will be tough, not tender and flaky.

Turn the dough out onto a lightly floured surface. Press together into a ball, then flatten into a disc about 6 inches in diameter (two discs for the two-crust recipe). Wrap in plastic wrap and refrigerate for 1 hour before continuing to allow the glutens in the flour to rest. The dough will keep refrigerated for up to 3 days, or may be frozen (double wrapped) for up to a month. Thaw at room temperature for an hour before using.

To prebake the pastry (bake blind) for a single-crust filled pie or tart, roll out pastry 1/8 inch thick to fit pan; crimp and seal edges. Prick bottom all over with a fork. Chill for 30 minutes. Preheat the oven to 400°F. Line pie pan with a sheet of aluminum foil or parchment paper and fill with pie weights, dry rice or beans. Bake for 15 minutes.

Nutritional analysis based on 12 servings per pie: 1 crust pie

Calories 138 (65% from fat) • pro. 1g • carbo. 11g • fat 10g
sat fat 1g • chol 20mg • sod. 48mg • fiber 0g

Nutritional analysis based on 12 servings per pie: 2 crust pie

Calories 277 (65% from fat) • pro 3g • carbo 22g • fat 20g
sat. fat 1g • chol. 40mg • sod. 104mg • fiber 0g

Old World Apple Crumb Pie

A creamy apple pie with crunchy, crumb topping

Makes 1 10-inch pie, 12 servings.

Preparation: 15 – 20 minutes, plus 40 minutes to prepare the pastry and 2 hours baking and cooling.

- | | | | |
|-----|---|-------|----------------------------------|
| 1 | single crust pastry recipe | 3 | large eggs |
| 1/2 | cup brown sugar | 3/4 | cup lowfat sour cream |
| 1/2 | cup walnuts, pecans or almonds | 1/2 | cup sugar |
| 1/4 | cup rolled oats | 1/4 | cup unbleached all-purpose flour |
| 1/4 | cup unbleached all-purpose flour | 1-1/2 | tablespoons vanilla |
| 1/4 | cup unsalted butter, at room temperature (not melted) | 1/4 | teaspoon salt |
| 3 | large apples (about 8 ounces each), peeled, cored and cut in 8ths (1 Granny Smith + 2 Golden Delicious, or 3 Winesaps or Pippins) | | |

Preheat the oven to 375° F.

On a lightly floured surface, roll out the pastry 1/8 inch thick, about 3 inches larger than the diameter of a 10-inch deep dish pie plate. Lift carefully, using a dough scraper to help lift the pastry. Loosely fold in half, then into quarters to form a wedge shape. Position the point of the wedge in the center of the pie plate and carefully unfold the dough into the pan. Make sure there are no air pockets between the dough and the pan. (If any tears in the crust occur, mend them by brushing lightly with water and pinching together, or patching with a scrap of rolled dough.) Trim evenly, leaving a 1-inch overhang. Lightly brush the edge of the pastry with water and fold over. Seal and crimp or flute decoratively. Refrigerate until ready to use. Roll the trimmings into a flat disk, wrap, refrigerate and reserve for another use or discard.

Insert the metal blade. Use the pulse to combine the brown sugar, nuts, oats, flour and butter. Pulse until the nuts are roughly chopped. Transfer to a bowl; knead with your fingers until the mixture resembles coarse crumbs. Refrigerate while continuing.

Insert the slicing disc. Arrange the apples in the large feed tube and slice. Transfer the apples to the piecrust; spread evenly in the crust. Insert the metal blade. Process the eggs, sour cream, sugar, flour, vanilla, and salt until smooth, about 10 seconds. Scrape the work bowl and process 5 seconds longer. Pour this mixture over the apples. Top with the reserved crumb mixture and bake in the bottom third of the preheated oven for 50 to 60 minutes, until golden, a little bubbly and slightly puffed. Check the pie after 30 minutes – if the crust begins to brown too much, cover with foil strips or commercially available piecrust shield strips for the duration of the baking time. Cool on a rack at least 1 hour before serving.

Nutritional analysis per serving:

*Calories 356 (48% from fat) • pro 6g • carbo. 41g • fat 19g • sat. fat 2g
chol. 86mg • sod. 150mg • fiber 1g*

Deep-Dish Pear and Apple Pie

Pears and apples combine to make a delightful taste combination.

If you want, you may use all pears or all apples.

Makes a 10-inch deep-dish pie - 12 servings

Preparation: 15 - 20 minutes, plus 40 minutes for preparing the pastry and 2-1/4 hours baking and cooling

Pastry for a 2 crust pie	3/4	cup dried cranberries
3 ripe but firm pears, about 8 ounces each, peeled, cored and quartered	1	tablespoon freshly squeezed lemon juice
3 Granny Smith Apples, about 8 ounces each, peeled, cored and quartered	1/4	cup real maple syrup (not pancake syrup)
juice of 1 lemon	1-1/2	teaspoons vanilla
4 tablespoons unbleached all-purpose flour		

Preheat the oven to 400°F.

On a lightly floured surface, roll out half the pastry to fit a 10-inch deep-dish pie plate, leaving a 1/2-inch overhang. Lift carefully, using a dough scraper to help lift the pastry. Loosely fold the dough in half, then into quarters to form a wedge shape. Position the point of the wedge in the center of the pie plate and carefully unfold the dough into the pan. Make sure there are no air pockets between the dough and the pan. (If any tears in the crust occur, mend them by brushing lightly with water and pinching together, or patching with a scrap of rolled dough.) Trim evenly, leaving a 1/2-inch overhang. Refrigerate until ready to use.

Insert the slicing disc. Arrange the pear quarters in the large feed tube and slice. Repeat until all the pears are sliced. Transfer to a bowl and toss gently with the juice of 1/2 lemon.

Reserve. Arrange the apple quarters in the feed tube. Use medium pressure to slice. Transfer to a bowl and toss with the juice of 1/2 lemon. Insert the metal blade. Process the remaining lemon juice, maple syrup and vanilla to combine.

Layer half of the apples in the prepared piecrust. Sprinkle with 1 tablespoon of the flour and 3 tablespoons of the dried cranberries. Top this with a layer of the pears sprinkled with 1 tablespoon of the flour and 3 tablespoons of the dried cranberries. Repeat both layers. Drizzle the maple syrup mixture evenly over the top of the fruit.

Roll out the remaining dough about 1/8 inch thick and about 2 inches larger than the diameter of the top of the pie plate. Brush the edges of the bottom crust with a little water. Carefully lay the top crust on the pie. Press gently to seal. Trim to the edge of the pie plate; crimp or flute decoratively. Make about 10 to 12 slits in the top crust decoratively with the tip of a very sharp knife. If desired, roll out some of the leftover crust and cut with small decorative cookie cutters. For this pie, you could use pears, apples and leaves. Brush the bottoms of the shapes with a little water and arrange decoratively on the top crust.

Bake the pie in the bottom third of the preheated oven for 60 to 70 minutes, covering the edges with foil if they begin to get too browned after about 35 to 40 minutes. Let the pie rest on a cooling rack for at least an hour before serving.

Nutritional analysis per serving:

Calories 399 (45% from fat) • pro. 4g • carbo. 53g • fat 21g
sat. fat 1g • chol. 40mg • sod. 106mg • fiber 3g

Dark Chocolate Truffles

A chocolate lover's dream come true.

Makes 2 cups ganache / 32 truffles

Preparation: 5 - 10 minutes, plus about 2 hours for chilling
and 15 - 20 minutes to shape and dust the truffles

1/4	cup unsweetened Dutch-process cocoa	3/4 cup + 1 tablespoon heavy cream
		2 tablespoons unsalted butter
15	ounces good quality bittersweet or semi-sweet chocolate such as Ghirardelli, Lindt or Callebaut, broken into 1-inch pieces, chilled	3 tablespoons brandy or other liqueur
		1-1/2 tablespoons vanilla

Insert the metal blade. Pulse to sift the cocoa; remove and reserve. Pulse to finely chop the chocolate, 20 to 30 times. Heat the cream in a saucepan or in the microwave until it is just bubbling at the edges. Stir in the butter. With the machine running, pour the mixture down the small feed tube and process until the mixture is smooth, about 1 minute. Scrape the work bowl.

With the machine running, add the brandy and vanilla; process to incorporate, about 10 seconds. Transfer the mixture to a small bowl. Cover with a piece of plastic wrap placed directly on the chocolate. Refrigerate until firm.

Divide the ganache into 32 equal portions. Shape into imperfect balls. Refrigerate 30 minutes. Dip the balls into the cocoa to coat lightly. Refrigerate for up to a week, or freeze for a month, well wrapped. If necessary, redust the truffles in the cocoa.

Nutritional analysis per truffle:

Calories 100 (62% from fat) • carbo 9g • pro 1g • fat 7g
sat. fat 1g • chol 10mg • sod 3mg • fiber 1g

Cuisinart®

SAVOR THE GOOD LIFE®



Coffeemakers



Food Processors



Toaster Ovens



Blenders



Cookware



Ice Cream Makers

Discover the complete line of Cuisinart® brand premier kitchen appliances including food processors, mini food processors, hand mixers, blenders, toasters, coffeemakers, cookware, ice cream makers and toaster ovens at

www.cuisinart.com

©2003 Cuisinart
Cuisinart® is a registered trademark of Cuisinart
150 Milford Road, East Windsor, NJ 08520
Printed in China
02CU13445
Lexan® is a registered trademark of General Electric Company

IB-3622E

Free Manuals Download Website

<http://myh66.com>

<http://usermanuals.us>

<http://www.somanuals.com>

<http://www.4manuals.cc>

<http://www.manual-lib.com>

<http://www.404manual.com>

<http://www.luxmanual.com>

<http://aubethermostatmanual.com>

Golf course search by state

<http://golfingnear.com>

Email search by domain

<http://emailbydomain.com>

Auto manuals search

<http://auto.somanuals.com>

TV manuals search

<http://tv.somanuals.com>