

Cuisinart®

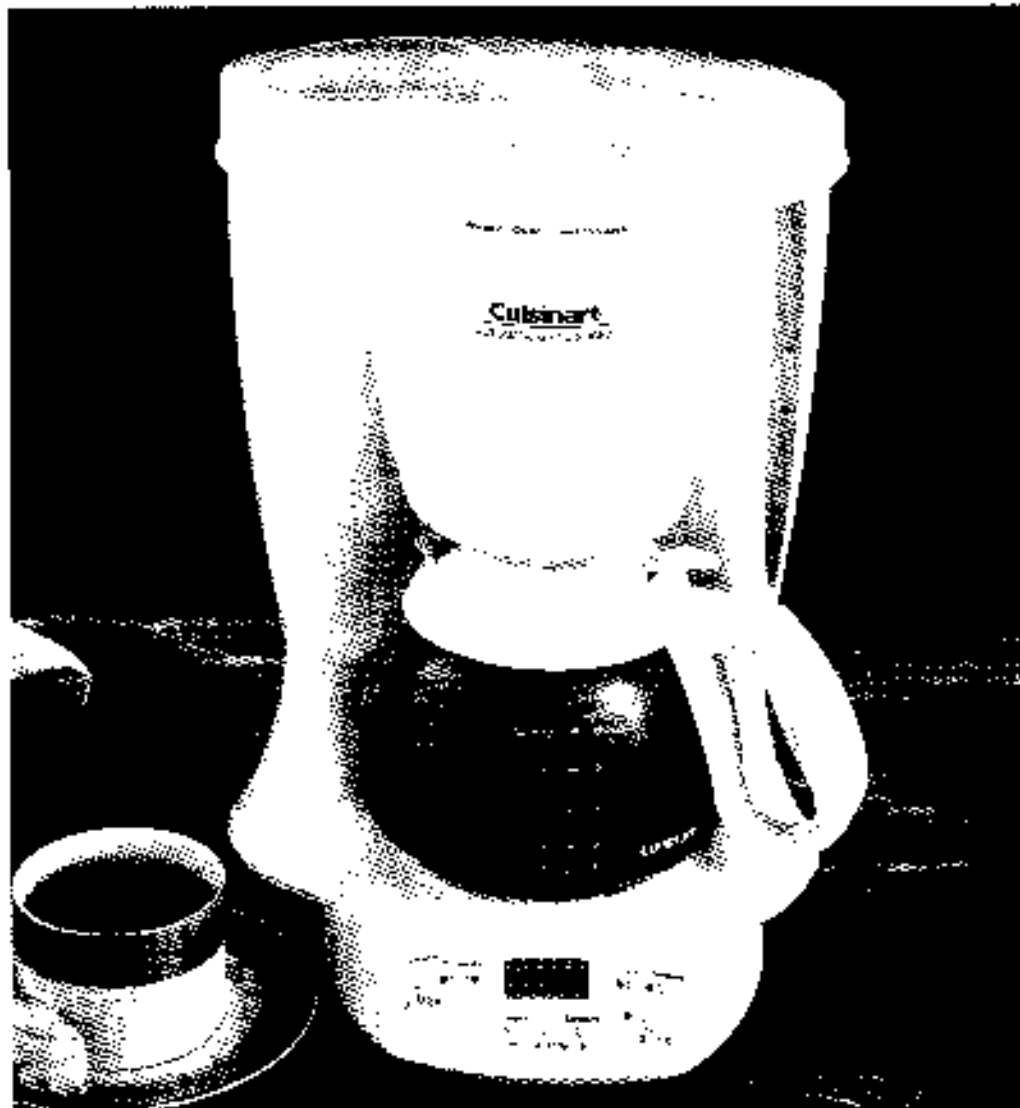

COFFEE BAR™ Automatic Grind & Brew

**DGB-300
SERIES**

IMPORTANT SAFEGUARDS

When using an electrical appliance, basic safety precautions should always be followed to reduce the risk of fire, electric shock, and/or injury to persons including the following:

1. **READ ALL INSTRUCTIONS.**
2. Do not touch hot surfaces. Use handles or knobs.
3. To protect against electric shock, do not place cord, plug, or base unit in water or other liquids.
4. Close supervision is necessary when any appliance is used by or near children.
5. Unplug from outlet when not in use and before cleaning. Allow to cool before putting on or taking off parts, and before cleaning appliance.
6. Do not operate any appliance with a damaged cord or plug or after the appliance malfunctions or has been dropped or damaged in any manner. Return appliance to the nearest Cuisinart Repair Center for examination, repair, electrical or mechanical adjustment.
7. The use of accessory attachments not recommended by Cuisinart may cause fire, electric shock or risk of injuries.
8. Do not use outdoors.
9. Do not let cord hang over edge of table or counter, or touch hot surfaces.
10. Do not place on or near a hot gas or electric burner, or in a heated oven.
11. Always fill water reservoir first, then plug cord into the wall outlet. To disconnect, turn controls to "off", then remove plug from wall outlet.
12. Do not use appliance for other than

intended use.

13. Snap lid securely onto carafe before serving any beverages.
14. Scalding may occur if the lid is removed during the brewing cycle.
15. The glass carafe is designed for use with these appliances only. It must never be used on the range top.
16. Do not set a hot carafe on a wet or cold surface.
17. Do not use a cracked carafe or a carafe having a loose or weakened handle.
18. Do not clean carafe or warming plate with cleansers, steel wool pads, or other abrasive materials.
19. **WARNING: TO REDUCE THE RISK OF FIRE OR ELECTRIC SHOCK, DO NOT REMOVE THE BASE PANEL. NO USER SERVICEABLE PARTS ARE INSIDE. REPAIR SHOULD BE DONE ONLY BY AUTHORIZED PERSONNEL.**
20. Avoid contacting moving parts.
21. Check grinder basket for presence of foreign objects before using.
22. Use the coffee grinder to grind roasted coffee beans only. Grinding other substances, such as nuts, spices or unroasted beans may dull the blade and cause poor grinding or injury.

SAW THESE INSTRUCTIONS HOUSEHOLD USE ONLY

WARNING RISK OF FIRE OR ELECTRIC SHOCK

A

The lightning flash with arrowhead symbol, within an equilateral triangle, is intended to alert the user to the presence of uninsulated "dangerous voltage" within the product's enclosure that may be of sufficient magnitude to constitute a risk of fire or electric shock to persons.

A

The exclamation point within an equilateral triangle is intended to alert the user to the presence of important operating and maintenance (servicing) instructions in the literature accompanying the appliance.

SPECIAL CORD SET INSTRUCTIONS

A short power-supply cord is provided to reduce the risks resulting from becoming entangled in or tripping over a longer cord.

Longer extension cords are available and may be used if care is exercised in their use.

If a long extension cord is used, the marked electrical rating of the extension cord should be at least as great as the electrical rating of the appliance, and the longer cord should be arranged so that it will not drape over the counter top or table top where it can be pulled on by children or tripped over.

NOTICE:

This appliance has a polarized plug (one blade is wider than the other). To reduce the risk of electric shock, this plug will fit in a polarized outlet only one way. If the plug does not fit fully in the outlet, reverse the plug. If it still does not fit, contact a qualified electrician. Do not modify the plug in any way.

UNPACKING INSTRUCTIONS

Place the box on a large, sturdy flat surface. Lay the box on its side. Slide the packaged unit out of the box. Remove the foam insert and the cardboard insert. Now remove the carafe from the coffee maker. Carefully lift the coffee maker from the remaining inserts. Remove the plastic bag from the coffee maker. We suggest you save all packing materials in the event that future shipping of the machine is needed. Keep all plastic bags away from children.



TABLE OF CONTENTS

Important Safeguards	p. 2
Unpacking Instructions	p. 3
Introduction	p. 4
The Coffee Bar™ Flavor System	p. 4
The Quest for the Perfect Cup of Coffee	p. 5
Features and Benefits	p. 6
Programming your Coffeemaker	
Setting the Clock	p. 10
Setting Programmed Time	p. 10
Programming Automatic-Off Time	p. 10
Variable Keep Warm Temperature	p. 11
Making Coffee	p. 12
Using Pre-Ground Coffee	p. 13
Cleaning and Maintenance	p. 13
Decalcification of Metal Parts	p. 14
Warranty	p. 14

INTRODUCTION

The Cuisinart® Coffee Bar™ Automatic Grind & Brew Coffeemaker is a coffee lover's dream. It delivers the freshest coffee in the world. The secret? It grinds the beans right before it brews them. Just add coffee beans to the grinder basket, fill the reservoir with water, put in your filter and press the "ON" button. In minutes, you'll have a wonderfully fresh pot of coffee.

Another reason this coffeemaker rewards you with pure coffee flavor is that it has the same brewing system found in coffee bars. It uses only the water needed to extract all the rich coffee taste without extracting any bitterness.

We know the Cuisinart® Automatic Grind & Brew will bring you years of pleasure. Nothing is more satisfying than a rich cup of your favorite brew.

THE COFFEE BAR™ FLAVOR SYSTEM

All coffee has the rich aromatic flavors we associate with a great cup of coffee, as well as the acidic, bitter flavors we associate with a bad cup. Commercial brewers have discovered that the "good" and "bad" flavors wash out of the grounds at a different rate, with the good flavors washing out faster than the bad. The trick is to use only enough water to wash out the good flavors and leave the bad behind. The relatively small amount of water needed to do this leaves a very strong cup of coffee, so it is necessary to add some water to bring it to a pleasant strength.

The Coffee Bar™ Flavor System does the work for you. Using the proportions and grind recommended, simply set the Flavor System dial for the number of cups you intend to brew. That's all there is to it! The Coffee Bar™ Flavor System automatically meters the correct amount of water through the grounds and directs the rest of the water into the carafe.

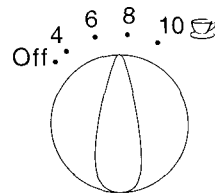

Coffee Bar™ Flavor System

Simply set the red dial for the number of cups of coffee you are brewing, and the Flavor System ensures great coffee bar flavor.

THE QUEST FOR THE PERFECT CUP OF COFFEE

It is generally agreed that there are four basic elements critical to the perfect cup:

Element 1: Water

Coffee is 98% water. Often overlooked, the quality of the water is as important as the quality of the coffee. If you filter your drinking water, filter the water for your coffeemaker. A good rule of thumb is that if your water doesn't taste good from the tap, it won't taste any better in your coffee.

For hard water areas, we recommend using bottled water. The calcium in the water and the softeners used to combat it have a major impact on the extraction of the coffee. Hard water will also accelerate calcium buildup inside the coffeemaker which slows down brewing, affects the flavor of the coffee and ultimately may shorten the life of your coffeemaker.

Element 2: Coffee

While the bulk of the liquid is water, all of the flavor should be from the coffee. To achieve the same great quality cup of coffee you receive at a coffee bar, you need to use the same quality beans.

Buy the beans fresh and whole, only about two weeks' supply at a time for maximum freshness. Once the coffee bean is broken, its flavor degrades very quickly. That's why the Automatic Grind and Brew grinds your coffee just prior to brewing. If it is not practical to buy small supplies, we recommend you separate larger amounts of beans into one to two week portions immediately after purchase and freeze them in airtight containers. The best way to maximize freshness is to minimize exposure to air, light and moisture. So, once removed from the freezer, maintain the beans in a sealed container at room temperature since damaging condensation occurs every time the beans are removed from the freezer or refrigerator. Note that some coffee experts advise against freezing dark-roast beans because it can cause the oils to coagulate, while others disagree. We suggest you experiment and decide for yourself.

Element 3: Grind

The grind is critical in proper flavor extraction. If the grind is too fine, overextraction and bitterness will result. Too fine a grind may also clog your filter. If too coarse, the water will pass through too quickly and the desired flavors will not be extracted. The Automatic Grind and Brew is pre-set for a medium grind, the optimal grind for this type of coffeemaker.

Element 4: Proportion

The Automatic Grind and Brew makes up to ten (10) 5-ounce cups of coffee.

Using Whole Beans:

- To make a full pot of coffee:
Fill the Grinder Basket to the top of the basket. **DO NOT OVERFILL, OR THE GRINDER COULD MALFUNCTION.**
- To make fewer than 10 cups of coffee:
We recommend you use about 1 measuring scoop of whole beans per cup. For 1 or 2 cups, use 1-1/2 measuring scoops **per cup. Note: One measuring scoop is approximately equal to one tablespoon.** This is our suggested recipe. Adjust the recipe to taste.

Using Pre-Ground Coffee:

Although it is **preferable** to use fresh, whole beans, you can make coffee in the Automatic Grind and Brew using pre-ground beans.

To do so, turn off the grinder by pressing the Grind Off button before turning the unit on.

Our recipe:

Use 1 to 1-1/2 measuring scoops of ground coffee per cup. **Note: One measuring scoop is approximately equal to one tablespoon.** This is our suggested recipe. Adjust the recipe to taste.

NOTE: The maximum capacity for ground coffee is 15 measuring scoops or tablespoons using either a paper or permanent filter. Exceeding this amount may cause overflow if the coffee is too finely ground.

FEATURES AND BENEFITS OF YOUR COFFEE BAR™ AUTOMATIC GRIND AND BREW COFFEEMAKER

At the Coffee Bar™ line of coffeemakers with people in mind. Every aspect has been designed to be easy to use. We made a large water window which is easily viewed from the front of the machine, and the reservoir lid opens to the back to give easy access for filling. The removable filter basket liner is molded in black plastic to avoid unsightly staining. We put rubber feet on the front of the machine only, so it's easy to move around on the counter top, yet won't slide as you set the controls. We also reasoned that an easy-to-hold carafe would allow you more control while pouring, helping to avoid spills. And we placed the carafe markings next to the handle, not on the side of the pot, so you can easily see them as you fill the carafe with water.

The Parts:

1. **Reservoir Cover:**
Press to open. Press to close. A Safety Interlock System prevents operation of the unit if the Reservoir Cover is open more than one half inch (1/2").
2. **Water Window:**
Markings indicate water needed to make corresponding cups of brewed coffee.
3. **Brew Pause (Not shown):**
Stops flow of coffee from basket when carafe is removed from heater plate so a cup can be poured in mid-brew, if desired. Since the extraction rate varies during the brew cycle, we recommend allowing the brewing cycle to finish before pouring the finished coffee.
4. **Carafe:**
 - a. **Taste Keeper™ Lid:** Minimizes oxygen flow into carafe to help preserve coffee flavor.
 - b. **Comfort Grip Handle:** Safe, controlled pouring.
 - c. **Brewed Coffee Markings:** These are located close to the handle for easier viewing.
5. **Coffee Temperature Monitor:**
Monitors the coffee temperature in the carafe and maintains it at the same level even if there is only a small amount of coffee remaining. Note: temperature is adjustable.
6. **Warming Plate**
7. **Cord Storage (Not shown):**
Unused cord is easily pushed into the coffeemaker to keep counters neat.
8. **Control Panel**
9. **Safety Interlock System (Not shown):**
Prevents operation of the unit if the reservoir cover is open more than 1/2 inch or the grinder basket lid and/or filter basket cover are not in place. An audible tone will sound continuously until cover is closed or the missing parts are in place and the cover is closed.
10. **Flavor System Settings:**
Set dial to number of cups being brewed to get optimum flavor extraction.

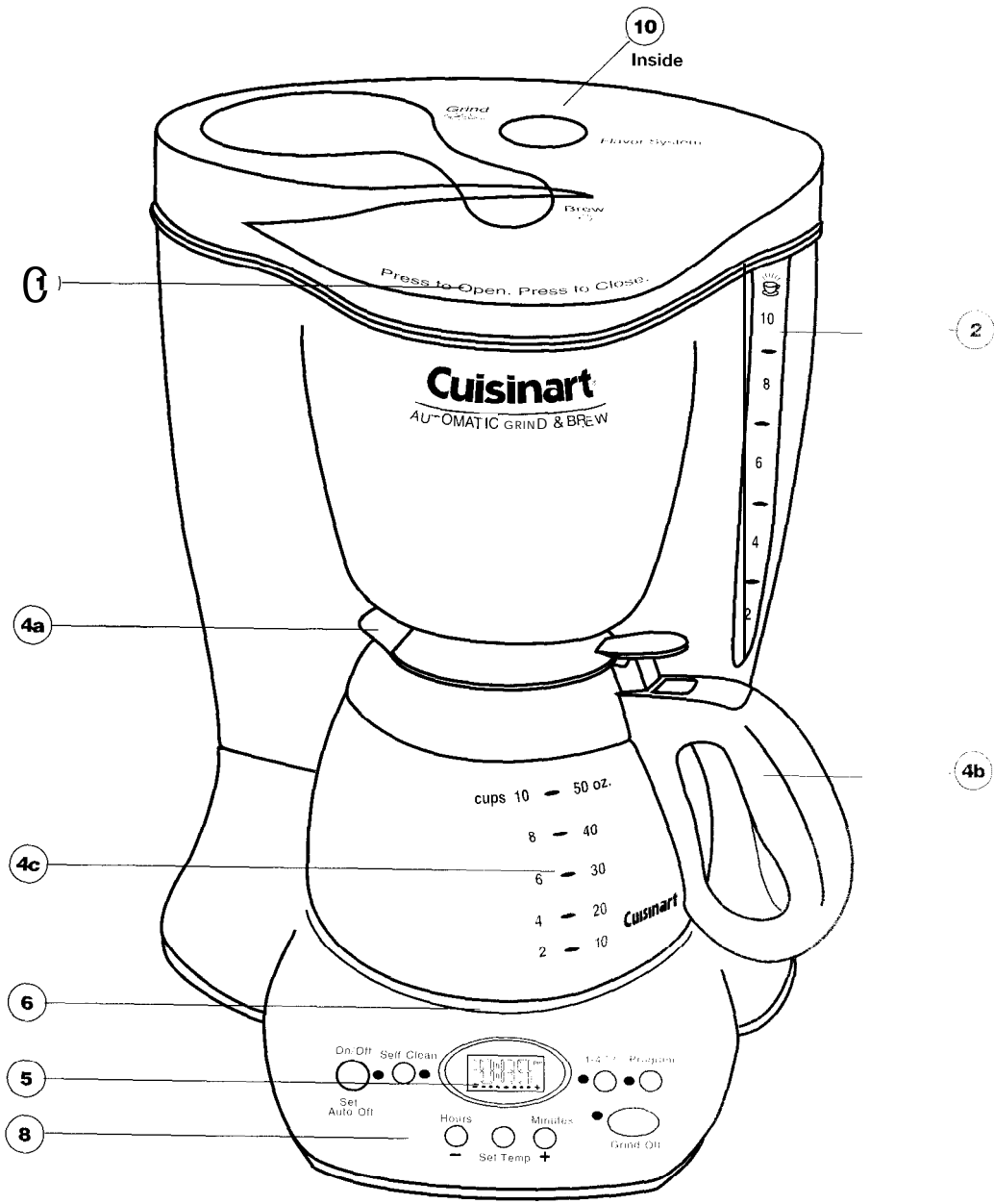

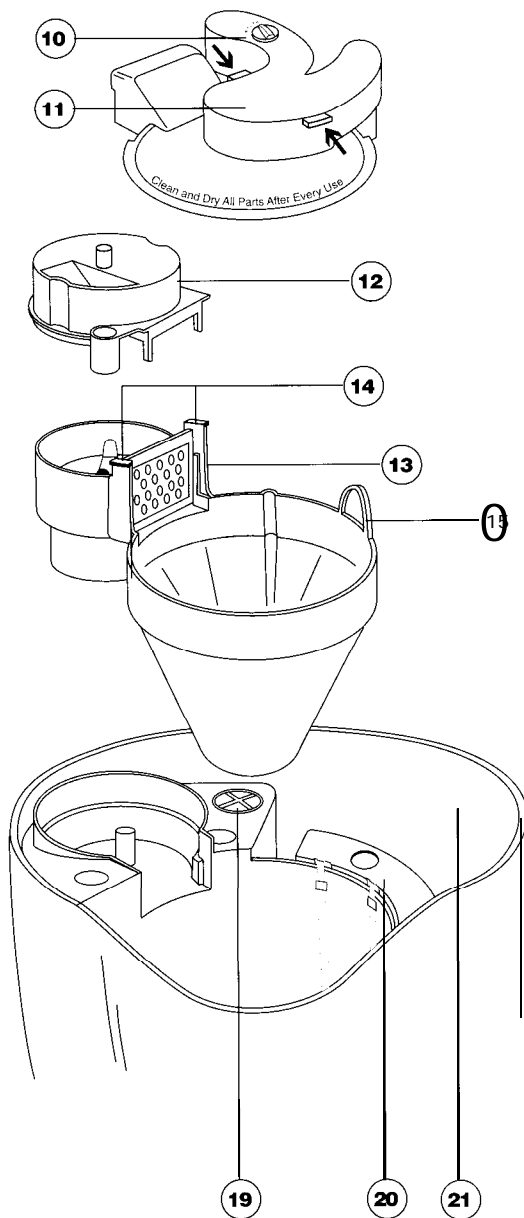

11. Filter Basket Cover/Filter Holder:
To put on or remove, grasp in area as indicated by arrows. NOTE: COVER MUST BE IN PLACE FOR UNIT TO OPERATE. Cover becomes hot after coffee is brewed. Use caution when removing cover.

Filter Holder has a self-centering ring to keep paper filters in the proper location. Note: This piece is intentionally loosely fitted to the filter lid.

12. Grinder Basket Lid:
Use the recess on each side of the lid to remove lid for easy addition of beans. Note: Lid must be in place for unit to operate.

13. Grinder/Filter Basket:
This is a one piece basket which holds the permanent or paper filter on one side, and the whole bean grinder on the other side. NOTE: FILTER BASKET MUST BE IN PLACE FOR UNIT TO OPERATE.

A Note About Filters: When using a permanent filter, be sure that the handle is positioned away from the grinder basket. If you do not, the handle may interfere with the flow of coffee into the filter basket. Also note, using a permanent or gold-tone filter will allow some fine coffee grounds to fall into the coffee carafe. This will appear as sediment in the carafe.

14. Finger Grips:
Use these and the Handle to easily lift the Grinder/Filter Basket out for cleaning.

15. Handle:
Use this and the Finger Grips to easily lift the Grinder/Filter Basket out for cleaning.

16. Gold-Tone Permanent Filter (not shown)

17. Measuring Scoop with Brush (not shown)

18. #4 Cone Paper Filters included (not shown)

19. Steam Safety Valve:
DO NOT TOUCH THIS VALVE. Doing so may release steam or hot water and cause personal injury. The valve is designed to keep steam away from exposed areas.

20. Steam Collector:
Prevents steam from escaping from unit. Unplug cord from outlet and allow unit to cool before cleaning. To clean: remove by lifting up and out. To replace: place hooks on Locating Notches.

21. Water Reservoir

Automatic Grind & Brew: Control Panel

(Detailed programming instructions are on pages 10 and 11)

1. On/Off/Set Auto-Shut Off Switch with LED Indicator:
 - a. Audible Tone (not shown): The Automatic Grind and Brew is equipped with an audible tone which will sound 5 times when the coffee has completed brewing (coffee will continue to stream from the filter for several more seconds thereafter) and will sound twice when the unit has shut itself off (See page 10).
2. Self Clean:
For use in decalcification of coffeemaker (See "Decalcification," page 14).
3. "Time to Clean" Indicator:
When the coffeemaker requires decalcification, this will flash whenever the coffeemaker is operated (See "Decalcification," page 14).
4. Hours Set | Temperature Decrease
5. Minutes Set | Temperature Increase
Press *and hold* either 4. or 5. for approximately 2 seconds to enter Time Set Mode.

6. Temperature Set:
Use to enter Temperature Set mode. Temperature is adjusted with Hours/(-) and Minutes/(+) buttons (See "Variable Keep Warm," page 11).
7. Carafe Temperature Display:
Displays keep warm temperature range relative to average setting. Temperature can be Increased or decreased.
6. Clock Display:
Displays time of day, program setting when program button is depressed, or Auto-Off time when On/Off button is depressed (See page 10).
9. Low Cups Setting with LED Indicator:
Set to "1-4 ☕" to improve extraction and flavor when making fewer than 5 cups of coffee (See page 13).
10. Program Setting with LED Indicator:
Press to display program setting or to set for programmed brewing (See page 10).
11. Grind Off:
Use to turn off the grinder when using pre-ground coffee (See page 12).

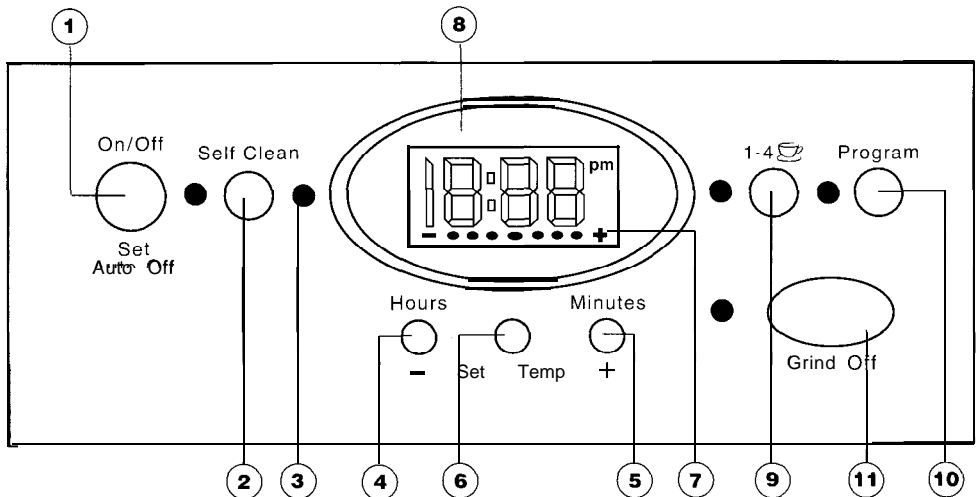

PROGRAMMING YOUR COFFEEMAKER

1. Setting the Clock:

When the coffeemaker is plugged in, 12:00 will flash continuously until you set the time.

Entering "Set time" Mode:

To set the time, hold down either the Hours or Minutes button until the clock stops flashing and begins to count up (about 2 seconds). You are now in the "Time Set" mode and can operate either button to achieve the desired setting. The buttons can be held down to scroll through the digits or pressed and released lightly to advance one digit at a time.

When scrolling, the numbers will advance slowly at first and then speed up to the rate of about three per second. When the number displayed approaches the desired setting, release the button and press repeatedly to advance one digit at a time. Be careful to make sure that the PM indicator is on if a PM time is desired.

Exiting "Set Time" Mode:

The "Time Set" mode can be exited in one of two ways:

1. Press any button besides the Hours or Minutes button. This will exit the "Time Set" and activate the selected function.
2. Do nothing. If neither the Hours nor Minutes button is pressed for a period of five seconds, the "Time Set" mode is exited.

2. Setting the Program Time:

To Start Program Feature:

To set the unit to make coffee at the programmed time, press the "Program" button and release it. The green light next to the button will light. The coffeemaker will start to brew at the programmed time.

If no time appears when the button is pressed and the green light turns off at the release of the button, it means that no program time has been set. The "Programmed" mode cannot be entered until the Program time has been set.

Entering "Set Program Time" Mode:
Press and hold the Program Set button (about 2 seconds) until the green light begins to flash. This signals that you have entered the "Set Program time" mode. The desired time can be set by pressing the Hours and Minutes buttons to scroll forward through the digits. Pressing and holding either button will allow you to scroll continuously, slowly at first, and accelerate to the rate of about three digits per second. As the desired time setting approaches, release the button and then press repeatedly to advance one digit at a time.

Exiting "Set Program Time" Mode:
"Set Program Time" may be exited in any of three ways:

1. Press the Program Set button. This will cause the coffeemaker to revert to its previous state. If it was OFF, it will return to the OFF position. If "Programmed", it will revert to this state, and so on. This is a safety feature.
2. Press any other button (except Hours or Minutes). "Set Program Time" will be exited and the function of that button will be executed.
3. Do nothing. If neither the Hours nor Minutes button is pressed for a period of five seconds, the "Set Program Time" mode is exited and the programmed setting will be in effect.

PROGRAMMING AUTOMATIC-OFF TIME

The Automatic-Off time can be programmed anywhere from immediate shut off after completion of the brew cycle to four hours. When the coffeemaker shuts itself off, two tones will sound. Four hours is the default time. The 0:00 setting shuts the unit off immediately after brewing is complete. To check the current setting, press and hold the On/Off button and the Automatic-Off time is displayed.

To change the preset time, press and hold the On/Off button until the red "power" light begins to flash. This signals that you have entered the "Set Automatic-Off" mode. Press the Hours and Minutes buttons to scroll forward through the digits until desired time appears. Thus, the first setting

which appears is preset at "4:00" and the next display would be "0:00" since four hours is the maximum Automatic-Off setting. Pressing and holding either button will allow you to scroll continuously, slowly at first, and **accelerate to the rate of about three digits per second**. As the desired time setting approaches, release the button and then press repeatedly to advance one digit at 3 time.

The Automatic-Off Time (AO) may be programmed either before or during coffee brewing. You may also re-program the AO time when brewing is completed. If you do so, the Automatic Grind and Brew will automatically account for any time that has already elapsed after brewing. For example, if you set the AO for 40 minutes and 25 minutes have already elapsed, the Grind and Brew will shut off automatically after 15 minutes (40 minutes minus the 25 elapsed equals 15 minutes).

VARIABLE KEEP WARM TEMPERATURE

The Automatic Grind and Brew has a method of setting the holding temperature of the coffee in the carafe. The display appears as a series of elliptical or oval-shaped dots across the lower portion of the digital readout and indicates the selected temperature relative to the holding temperature preset at the factory.

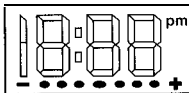

If you use 3 lot of milk in your coffee, set it higher than normal. If you prefer a cooler temperature to your coffee, lower the temperature. We encourage you to experiment and determine what is best for you. Please note that the heater plate on the coffeemaker is not powerful enough to raise the temperature of the coffee in the pot once it has been brewed. This feature is designed as a "1x-c-set" and will affect the coffee during the brewing cycle. If the coffee is too hot, the temperature can be lowered, but since we do not recommend leaving the coffee on direct heat for more than twenty minutes, the simplest way to reduce the heat is to shut the coffeemaker off and allow coffee to cool before transfer to a thermal carafe.

Never use the carafe on a heated stove top.

To Set Temperature:

Press the Set Temp button on your coffeemaker. The time display will disappear and only the Temperature Display remains. The (-) and (+) buttons (same as Hours and Minutes, respectively) can then be used to increase or decrease the holding temperature. The selected temperature will remain programmed until you change it or the coffeemaker is unplugged.

INCREASING THE TEMPERATURE:

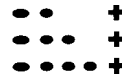

DECREASING THE TEMPERATURE:

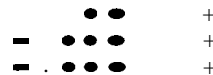

Exiting "Set Temperature" Mode:

There are three ways to exit "Set Temperature" mode:

1. Press Set Temp button. Time display reappears.
2. Press any button besides (-), (t) and Temp Set. The function of the button pressed will be executed.
3. Do nothing. If neither the (-) nor (+) button is pressed for a period of five seconds, the "Set Temperature" mode is exited.

NOTE: If at any time during the life of the coffeemaker, the temperature display bar begins to flash and the Temp Set button has no effect on the display, damage to the Coffee Temperature Monitor is indicated. The coffeemaker will otherwise continue to function normally. Because there are no user-serviceable parts inside, the coffeemaker must be returned to an authorized Cuisinart Repair Center if servicing is desired.

TURNING GRIND FUNCTION OFF

To turn off the grinding function, press the Grind Off button. A yellow LED will be illuminated. Then press the On button.

MAKING COFFEE

Before making the first pot of coffee in your new Cuisinart® Coffee Bar™ Automatic Grind and Brew coffeemaker, we recommend operating the coffeemaker once using only water and a paper filter. This will remove any dust or residues in the system which remain from the manufacturing process.

1. Fill the Water Reservoir:

Remove the carafe from the hot plate. Open the carafe cover and fill with cold water to just over the amount of coffee you are making. Close the carafe cover. Press the reservoir lid to open. Pour the water from the carafe into it. The numbers on the water reservoir indicate a slightly higher amount of water per cup than the carafe markings. This is to compensate for the amount of water lost in wetting the grounds and lost as steam during the brewing process. The float on the water window indicates the amount of water necessary to brew the corresponding amount of coffee.

Replace the carafe on the hot plate.

2. Set the Flavor System:

The Flavor System has been designed to extract the proper coffee flavor compounds **when the dial is positioned according to the number of cups being brewed.**

NOTE: If you use less than the recommended coffee measure, or you use a grind that is finer than the recommended grind, set the Flavor System to a higher cup setting. This takes more water away from the grounds to prevent over-extraction. Conversely, if you use more coffee or a coarser grind, set it to a lower setting.

To deactivate the Flavor System, turn the selector knob counterclockwise to the "OFF" setting. Close the lid of the reservoir.

3. Add Beans/Filter:

Lift the Grinder Basket Lid using the recess on either side. Fill the basket with the desired quantity of beans. Lift the Filter Basket Cover/Filter Holder. (See Parts list for best location to grasp). Place a #4

cone filter or a permanent filter in the basket.

Note: When using a permanent filter, be sure that the filter handle is facing away from the grinder basket. If you do not do so, the handle may interfere with the flow of ground coffee into the filter basket. Also note, a permanent filter may allow some ground coffee to flow into carafe.

The Filter Holder will help to keep the filter open, but when using a paper filter, be sure that the filter is completely open and fully inserted into the basket.

To make a full pot of coffee (10 cups), fill the grinder basket to the top of the basket.

To make fewer than 10 cups of coffee, use about 1 measuring scoop of whole beans per cup. For 1 or 2 cups, use 1-1/2 measuring scoops **per cup. Note: One measuring scoop is approximately equal to one tablespoon.** This is our suggested recipe. Adjust the recipe to taste. Do not fill above the top of the grinder basket.

4. Close the Reservoir Lid:

Press down to Lock. To prevent coffee grounds from escaping the grinding chamber make sure reservoir lids locked.

The Automatic Grind and Brew is equipped with a Safety Interlock System. The Grind and Brew will not operate if the cover of the unit is open more than 1/2 inch or the grinder cover and/ or the filter cover are left out. If you try to turn the unit on, it will beep continuously until the missing parts are installed and the cover is closed. The unit will also beep if you open the cover during the brewing process. If grinding, the grinder will stop. If brewing, the brewing will stop: Once the missing parts are installed and the cover is closed, the beeping will stop. The brewing process can be restarted by pressing the "On" button. Restarting the process will not affect coffee results. If you do not want the grinder to come on again, press the "Grind Off" button before pressing the "On" button.

5. Before Brewing Coffee

Make sure you have replaced the glass carafe into its position on the warming plate and placed a filter in the Grinder/Filter basket. Plug the cord into an electrical outlet. The clock will flash "12:00" con-

tinuously until the clock has been set. This will not interfere with the operation of the coffeemaker. To set clock, see the "Programming Your Coffeemaker" section, page 10.

Check to see that the Automatic-Off Time and the Carafe Keep Warm Temperature settings are as you desire. For information on these features see "Programming Your Coffeemaker" on page 10.

6. Power Unit:

a) Immediate Grinding and Brewing:

Switch the control panel to ON. The indicator will light and the process will begin.

h) Programmed Brewing:

Press the "Program" button and release it. The green LED will light. If the indicator light goes off once the button is released, it means the program has not been set. To set the programmed time, see "Programming Your Coffeemaker" on page 10.

7. Select Cups Setting:

If you are brewing fewer than 5 cups, press the "1-4 " button. The indicator light will illuminate. Note that the light will only come on if the coffeemaker has been turned on or set to the "program" mode first.

6. During and After Brewing:

The Brew Pause allows you to remove the carafe from the heater during mid brew. The brewing process does not stop during this period, only the flow of coffee from the basket. Do not remove the carafe for longer than 30 seconds or the coffee may overflow the basket. While we offer this feature, we do not recommend you pour coffee before the cycle has reached completion, since the coffee brewed at the beginning of the cycle has a flavor profile which is very different from the coffee brewed at the end of the cycle. Removing a cup during the brewing cycle will alter the flavor of the finished pot.

Once the coffee has finished brewing, stir it before serving to blend the flavors. The coffee at the bottom of the carafe will be somewhat stronger than the coffee at the top.

When the brewing cycle is completed, five beeps will sound. Coffee will continue to stream from the filter for several more seconds.

After brewing, the heater plate will keep the coffee

at about 180-185°F. We recommend transferring the coffee to a thermal carafe preheated with hot water if the coffee is **not going to be drunk** within 20 minutes.

TO MAKE COFFEE WITH PRE-GROUND COFFEE:

Follow instructions 1. and 2 from Making Coffee section.

3. Add Ground Coffee to Permanent or #4 cone Paper Filter. Our recipe suggestion: Use 1 to 1-1/2 measuring scoops of ground coffee per cup. Note: One measuring scoop is approximately equal to one tablespoon. This is our suggested recipe. Adjust the recipe to taste.

NOTE: The maximum capacity for ground coffee is 15 tablespoons or measuring scoops using either a paper or permanent filter. Exceeding these amounts may cause overflow if the coffee is too finely ground.

4. Close the Reservoir Lid (See instructions above).

5. See "Before Brewing Coffee" note above. Press the Grind Off button. When this function is activated, a yellow LED will be illuminated. Then Press the ON button.

6. Follow instructions 6 through 8 from the Making Coffee section.

CLEANING AND MAINTENANCE

COMPLETELY CLEAN AND DRY ALL PARTS AFTER EVERY USE.

Always turn coffeemaker OFF and remove the plug from the electrical outlet before cleaning it.

Press the Reservoir Lid and lift open the Lid. Remove the Grinder Basket Lid by using the recessed area on each side of the lid. Remove the Filter Basket Cover. Remove the permanent or paper filter. Clean permanent filter or discard the paper filter. Remove the Grinder/Filter Basket, using the Finger Grips and Handle. The Grinder/Filter Basket, Grinder Basket Lid, and Filter Basket Cover can be washed in warm soapy water and rinsed thoroughly or cleaned in the upper rack of the dishwasher. Dry all parts after

every use.

Do not put any water in the unit once the Grinder/Filter basket has been removed. Wipe the area under the Grinder/Filter basket with a damp cloth. If water gets into the grinder motor, the motor may become damaged.

once clean, reverse the above steps.

Periodically remove the Steam Collector by lifting it up and out. Run it under warm soapy water. Rinse thoroughly. Replace the Steam Collector by placing the hooks on the Locating Notches.

Remove the carafe from the warming plate. Discard any remaining coffee. The carafe and lid can be washed in warm soapy water and rinsed thoroughly, or placed in a dishwasher. The carafe and carafe lid should be placed on the upper rack only.

Do not use scouring agents or harsh cleansers on any part of the coffeemaker.

Never immerse base unit in water or other liquid. To clean base, simply wipe with a clean, damp cloth and dry before storing. Wipe warming plate with a clean, damp cloth. Never use rough, abrasive materials or cleansers to clean the warming plate. Do not dry the inside of the water reservoir with a cloth, as lint may remain.

DECALCIFICATION

Decalcification refers to removing the calcium deposits which form on the metal parts of the coffeemaker over time.

For best performance from your Coffee Bar™ Coffeemaker, decalcify the base unit from time to time. The frequency depends upon the hardness of your tap water and how often you use the coffeemaker. The flashing Self-Clean light will indicate when you should clean your coffeemaker.

Self Cleaning

If the Self Clean light begins to flash when the coffeemaker is turned on, it is telling you that the calcium buildup is interfering with the functioning of your coffeemaker and the flavor of your coffee. To clean, fill the water reservoir to capacity with a mixture of 1/3 white vinegar and 2/3 water. Press the Self-Clean button. When the self-clean light glows, turn the coffeemaker on by pressing the ON button. The self-clean light will shine steadily. The

coffeemaker is now in Self Clean Mode. One cycle should be sufficient to adequately clean the coffeemaker. When the cycle is completed and the fire beeps sound, the coffeemaker will shut off. Turn the coffeemaker ON to see if the Self-Clean light continues to flash. If it does, turn it OFF and then repeat the cleaning procedure with a fresh solution of vinegar and water.

If the Self Clean light no longer flashes, turn the coffeemaker to OFF and then run one cycle of fresh cold water through the unit before using the unit again to brew coffee.

Notes on the Self Clean Function:

Pressing the Self Clean button cancels all other settings. If it is pressed accidentally, press it again to return the coffeemaker to all its previous settings. Pressing On/Off will also exit the Self Clean Mode and turn the coffeemaker OFF.

WARRANTY

THREE-YEAR LIMITED WARRANTY

This warranty supersedes all previous warranties on Cuisinart® Coffee Bar™ Automatic Grind and Brew Coffeemakers.

This warranty is available to consumers only. You are a consumer if you own a Cuisinart® Coffee Bar™ Automatic Grind and Brew Coffeemaker that was purchased at retail for personal, family or household use. Except as otherwise required under applicable state law, this warranty is not available to retailers or other commercial purchasers or owners.

We warrant that your Cuisinart® Coffee Bar™ Automatic Grind and Brew Coffeemaker will be free of defects in material or workmanship under normal home use for three years from the date of original purchase.

We suggest that you complete and return the enclosed warranty registration card promptly to facilitate verification of the date of original purchase. However, return of the warranty registration is not a condition of these warranties.

If your coffeemaker should prove to be defective within the warranty period, we will repair it (or, if we think it necessary, replace it) without charge to you. To obtain warranty service, please call our Consumer Service Center toll-free at 800-726-0190 or write to:

Cuisinart
150 Milford Road
East Windsor, NJ 08520

To facilitate the speed and accuracy of your return, please also enclose \$10.00 for shipping and handling of the product. Please also be sure to include a return address, description of the product defect, product serial number, and any other information pertinent to the product's return. Please pay by check or money order.

Your Cuisinart® Coffee Bar™ Automatic Grind and Brew coffeemaker has been manufactured to strict specifications and has been designed for use with the Cuisinart™ coffeemaker authorized accessories and replacement parts for your model. These warranties expressly exclude any defects or damages caused by accessories, replacement parts or repair services other than those that have been authorized by Cuisinart.

These warranties do not cover any damage caused by accident, misuse, shipment or other than ordinary household use.

These warranties exclude all incidental or consequential damages. Some states do not allow the exclusion of or limitation of incidental or consequential damages, so the foregoing limitation or exclusion may not apply to you.

CALIFORNIA RESIDENTS ONLY

California law provides that for In-Warranty Service, California residents have the option of returning a nonconforming product (A) to the store where it was purchased or (B) to another retail store which sells Cuisinart® products of the same type. The retail store shall then, at its choice, either repair the product, refer the consumer to an independent repair facility, replace the product, or refund the purchase price less the amount directly attributable to the consumer's prior usage of the product. If either of the above two options do not result in the appropriate relief to the consumer, the

consumer may then take the product to an independent repair facility if service or repair can be economically accomplished.* Cuisinart and not the consumer will be responsible for the reasonable cost of such service, repair, replacement, or refund for nonconforming products under warranty.

California residents may also, at their preference, return nonconforming products directly to Cuisinart for repair or, if necessary, replacement by calling our Consumer Service Center toll-free at 800-726-0190. Cuisinart will be responsible for the cost of the repair, replacement, and shipping and handling for such nonconforming products under warranty.

BEFORE RETURNING YOUR CUISINART PRODUCT

If you are experiencing problems with your Cuisinart® product, we suggest that you call our Consumer Service Center at 1-800-726-0190 before returning the product for servicing. Often, our Consumer Service Representatives can help solve the problem without having the product serviced. If servicing is needed, a Representative can confirm whether the product is under warranty and direct you to the nearest service location.

* Important: If the nonconforming product is to be serviced by someone other than Cuisinart's Authorized Service Center, please remind the servicer to call our Consumer Service Center to ensure that the problem is properly diagnosed, the product serviced with the correct parts, and to ensure that the product is still under warranty.

Free Manuals Download Website

<http://myh66.com>

<http://usermanuals.us>

<http://www.somanuals.com>

<http://www.4manuals.cc>

<http://www.manual-lib.com>

<http://www.404manual.com>

<http://www.luxmanual.com>

<http://aubethermostatmanual.com>

Golf course search by state

<http://golfingnear.com>

Email search by domain

<http://emailbydomain.com>

Auto manuals search

<http://auto.somanuals.com>

TV manuals search

<http://tv.somanuals.com>