

Cuisinart® for



INSTRUCTION/RECIPE BOOKLET



**Buona Tazza™ Single Serve
Espresso Machine**

EM-300 SERIES

For your safety and continued enjoyment of this product, always read the instruction book carefully before using.

Download from Www.Somanuals.com. All Manuals Search And Download.

IMPORTANT SAFEGUARDS

We at Cuisinart are very safety conscious. We design and manufacture consumer products with the safety of you, our valued customer, foremost in mind. In addition we ask that you exercise a degree of care when using electrical appliances and adhere to the following precautions.

When using electrical appliances, basic safety precautions should always be followed, including the following:

- CAREFULLY READ ALL INSTRUCTIONS BEFORE OPERATING APPLIANCE, AND SAVE THIS MANUAL FOR FUTURE REFERENCE.**
- Unplug from outlet when not in use and before cleaning. Allow to cool before putting on or taking off parts, and before cleaning the appliance.**
- To protect against fire, electrical shock and injury to persons do not immerse the appliance, cord or plug in water or any other liquid.
- This appliance is for household use only.
- Do not operate the unit with the brewing head open.
- Do not use this appliance for anything other than its intended use.
- This appliance should not be used by or near children or individuals with certain disabilities.
- Do not leave the appliance unattended when in use.
- Do not touch hot surfaces. Use handles or knobs.
- Always use the appliance on a dry, level surface.
- To disconnect, turn all controls off, then remove plug from power outlet.
- Do not place this appliance on or near a hot gas or electric burner, or where it could touch a heated oven.
- Do not let the cord hang over the edge of a table or counter or touch hot surfaces or become knotted.
- The use of accessory attachments not recommended by Cuisinart may cause a risk of injury to persons, fire or electrical shock.
- Strictly follow cleaning and care instructions.
- Do not use this appliance for anything other than its intended use. Do not use in moving vehicles or boats.
- Do not use outdoors.
- Always switch the appliance off, and then remove plug from the power outlet when the appliance is not being used and before cleaning.
- An extension cord is not recommended. However, if one is needed, the extension cord should be a grounded type and its electrical rating must be the same or higher wattage as the appliance. Regularly inspect the supply cord, plug and actual appliance for any damage. If found damaged in any way, immediately cease use of the appliance and call Cuisinart Customer Service at 1-800-726-0190.
- For any maintenance other than cleaning, call Cuisinart Customer Service at 1-800-726-0190.
- Refer servicing to qualified personnel.
- Do not operate any appliance with a damaged cord or plug or after the appliance malfunctions, or has been damaged in any manner. Return appliance to the nearest authorized service facility for examination, repair or adjustment.
- Do not operate your appliance in an appliance garage or under a wall cabinet. **When storing in an appliance garage always unplug the unit from the electrical outlet.** Not doing so could create a risk of fire, especially if the appliance touches the walls of the garage or the door touches the unit as it closes.

SAVE THESE INSTRUCTIONS FOR HOUSEHOLD USE ONLY

WARNING: RISK OF FIRE OR ELECTRIC SHOCK



The lightning flash with arrowhead symbol within an equilateral triangle is intended to alert the user to the presence of uninsulated dangerous voltage within the product's enclosure that may be of sufficient magnitude to constitute a risk of fire or electric shock to persons. The exclamation point within an equilateral triangle is intended to alert the user to the presence of important operating and maintenance (servicing) instructions in the literature accompanying the appliance.



WARNING
RISK OF FIRE OR ELECTRIC SHOCK
DO NOT OPEN

WARNING: TO REDUCE THE RISK OF FIRE OR ELECTRIC SHOCK,
DO NOT REMOVE COVER (OR BACK)
NO USER-SERVICEABLE PARTS INSIDE
REPAIR SHOULD BE DONE BY AUTHORIZED SERVICE PERSONNEL ONLY

SPECIAL SAFETY INSTRUCTIONS

1. Use only cold water in the water reservoir.
Do not use any other liquid.
2. Never use the machine without water in it.
3. Scalding may occur if the brewing head is opened during brewing cycle.

NOTE: For safety reasons it is recommended you plug your Cuisinart appliance directly into the power outlet. Use in conjunction with a power strip or extension cord is not recommended.

SPECIAL CORD SET INSTRUCTIONS

A short power-supply cord is provided to reduce the risks resulting from becoming entangled in or tripping over a longer cord.

Longer extension cords are available and may be used if care is exercised in their use.

If a long extension cord is used, the marked electrical rating of the extension cord must be at least as great as the electrical rating of the appliance. The extension cord should be a grounding-type 3-wire cord, and the longer cord should be arranged so that it will not drape over the countertop or tabletop where it can be pulled on by children or tripped over.

NOTICE

If you have a die-cast metal unit, for your protection it is equipped with a 3-conductor cord set that has a molded 3-prong grounding-type plug, and should be used in combination with a properly connected grounding-type outlet as shown in Figure A.

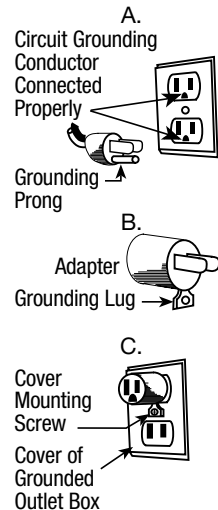

If a grounding-type outlet is not available, an adapter, as shown in Figure B, may be obtained so that a 2-slot wall outlet can be used with a 3-prong plug. As shown in Figure C, the adapter must be grounded by attaching its grounding lug under the screw of the outlet cover plate. **NOTE: Do not remove the grounding prong.**

CAUTION: Before using an adapter, it must be determined that the outlet cover plate screw is properly grounded. If in doubt, consult a licensed electrician. Never use an adapter unless you are sure it is properly grounded.

Note: Use of an adapter is not permitted in Canada.

CONTENTS

Important Safeguards.....	2
Unpacking Instructions	4
Introduction	4
Features and Benefits	5
Preparing Your Espresso Machine	6
Using Your Espresso Machine	6
Programming	7
Temperature Controls.....	7
Cleaning and Maintenance	7
Troubleshooting	8
Recipes	9
Steaming/Frothing Instructions	10
Warranty.....	16

IMPORTANT UNPACKING INSTRUCTIONS





1. Place the box on a large, sturdy, flat surface.
2. Remove the instruction book and any other literature.
3. Remove the sample pack of illy's iperEspresso capsules.
4. Turn the box so that the backside of the machine is down, and slide the espresso maker from the box.
5. After the espresso maker has been removed, place the box and the side pulp-molded inserts out of the way.
6. Remove all packing materials, tape, etc.

We suggest you save all packing materials in the event that future shipping of the machine is needed. Keep all plastic bags away from children.

INTRODUCTION

Cuisinart and illy are proud to introduce this Buona Tazza™ Single Serve Espresso Machine powered by Cuisinart and featuring illy's proprietary iperEspresso capsule system. This combines Cuisinart's excellence in coffeemakers and illy's legendary coffee heritage to bring the pleasure of savoring the rich, smooth taste of illy to the comfort of your own home.

FEATURES AND BENEFITS

- 1. Water Reservoir Lid**
- 2. Removable 34-ounce Water Reservoir**
- 3. Cup-Warming Plate**
Convenient place to warm cups.
- 4. 19 Bar Pump (not shown)**
- 5. Brew Head Lever**
Use the die-cast metal lever to open and close the brew head.
- 6. Brew Head**
- 7. Brewing Spout**
Strategically positioned for optimal results.
- 8. Used Capsule Container**
(Also contains some residual liquid left after brewing.)
- 9. Espresso Cup Tray**
Folds up when taller mugs need to be used.
- 10. Drip Tray Grate**
- 11. Removable Drip Tray**
- 12. Travel Mug Tray**
- 13. Power Switch**
- 14. Short Espresso Button** 
- 15. Long Espresso Button** 
- 16. Manual/Adjustable Strength Control/Programmable Button** 
- 17. Hot Setting Button** 

Default coffee temperature setting.

- 18. Extra-Hot Setting Button** 

Select for hotter coffee temperature, and wait just a few seconds for heat-up.

- 19. Energy Saver Mode (not shown)**
Saves 50% of power after 30 min. non-use.
- 20. Auto Off Mode (not shown)**
Shuts off after 60 min. non-use.
- 21. Power Cord (not shown)**
- 22. BPA Free (not shown)**
All materials that come in contact with liquid are BPA free.
- 23. 14-Capsule Pack (not shown)**
Choose from 100% Arabica varieties!

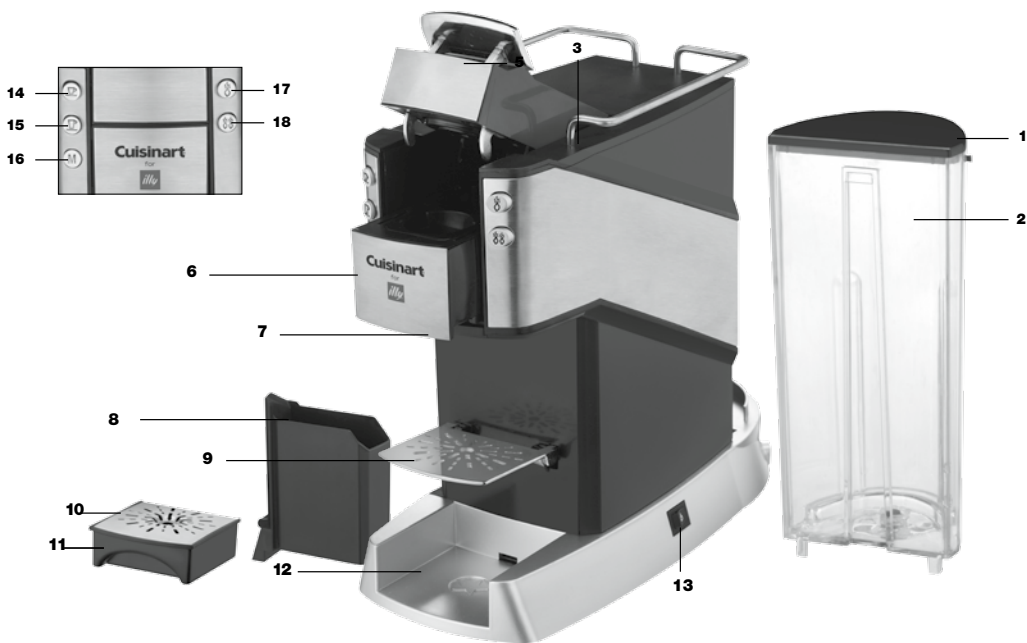

PREPARING YOUR ESPRESSO MACHINE

1. Put the espresso machine on a dry, stable countertop or other flat, sturdy surface where you will be using the machine.
IMPORTANT: For first-time use or if the machine has not been used for some time, it is important that it is rinsed as follows:
2. Remove the lid of the water reservoir. Using the handle, lift the water reservoir off the base and fill with fresh, cold drinking water. Replace the water reservoir on the base, and cover with the lid. Using the tracks as a guide, slide the water reservoir back into position and push down firmly to engage.
Important: The unit will not function unless the water reservoir is properly in place.
3. Insert the plug into a power outlet. Press the power button once to turn the espresso machine on. All of the controls on the front of the machine will flash while it's pre-heating. Lights will turn steady when the unit is in ready mode (approximately 1 minute).
4. Make sure the drip tray and grate are in place.
5. Place a mug on the drip tray.
6. Press the Manual **M** button and allow the water to run through for approximately 5 to 10 seconds. Press once more to stop.
7. Position espresso cups on the warming plate.
8. The machine is now in preheat/ready mode and ready to use.

NOTE: If the water reservoir is empty, the unit will not function. The Short **S**, Long **L**, and Manual **M** LEDs will flash. Turn off the machine, fill the water reservoir, and turn the machine back on.

USING YOUR ESPRESSO MACHINE

Always make sure you have water in the reservoir, a capsule in the brew head, and that the appropriate tray is being used.

NOTE: This machine is designed exclusively for use with illy's iperEspresso capsules. Any other type of capsule, pod, or coffee is not used.

Single or Double Pre-Programmed Espresso

1. Using the lever, open the brew head, insert a capsule, and close the brew head.



2. With an espresso cup on the espresso cup tray, select either a SHORT **S** (1.5 ounces) or LONG **L** (3 ounces) espresso. (The selected function and Hot Temperature setting LEDs remain on, while all the other LEDs are off. Once all LEDs are on again, the machine is ready for the next cycle.)

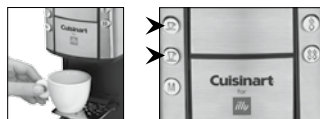

NOTE: As part of illy patented technology in the iperEspresso capsule, the brewing process is completely self-contained in the capsule and does not get into the brew head. So there is no need to rinse in between cycles as there will be no transfer of flavor.

Manual/Adjustable Strength Control Programmable

1. Using the lever, open the brew head, insert a capsule, and close the brew head.



2. For adjustable strength control, use the MANUAL **M** button to adjust the length of time espresso is dispensing – the longer you allow it to flow, the lighter it will be.

Press **M** to start dispensing. When your cup is filled to desired level, press **M** again to stop.



PROGRAMMING A CUSTOM SETTING

At ready mode, hold and press **MANUAL M** for 3 seconds to customize the **SHORT** **☒** and **LONG** **☒** output.

1. **☒**, **☒**, **M** are ON. If no action within 30 seconds, unit returns to preheat/ready mode.



--OR--

2. Press **☒** or **☒** button.
 - a. **☒** or **☒** LED remains on.
 - b. Espresso is dispensed.
 - c. When desired amount is dispersed into cup, press **M** again. That will be the programmed amount.
 - d. **☒** or **☒** LED turns off and unit returns to preheat/ready mode.

To reset to factory setting at ready mode, press and hold **M** and **☒** at the same time for 3 seconds.



1. **☒**, and **☒** and **M** LEDs flash 3 times.
2. Default setting is on and unit will return to preheat/ready mode.

TEMPERATURE CONTROLS

Hot **☒** is the default setting. If Extra Hot is desired, press the **☒** button and allow less than 10 seconds for the temperature to rise. The flashing light will turn steady when it has reached temperature.



Energy Saver Mode

After 30 minutes of non-use the espresso machine will automatically switch to sleep mode and all the control lights will be dimmed by about 50%. When any button is pressed, the espresso machine will return to

preheat mode and all the lights will flash. The machine is ready to operate when all the lights are steady again.

Auto-Off Mode

Following the 30-minute Energy Saver cycle, if there is an additional 30 minutes of non-use, the espresso machine will turn off. Press the power button to turn on again.



CLEANING AND MAINTENANCE

Cleaning External Parts

We recommend regular cleaning of the espresso maker's external components.

1. Never immerse the machine in water or other liquids. The housing and external parts may be cleaned with a soapy, damp, non-abrasive cloth.
2. To remove the drip tray, simply slide it toward you, keeping it level at all times in order to prevent spills. The drip tray and drip tray grate are dishwasher safe. Do not clean drip tray with cleansers, steel wool pads or other abrasive materials.

Cleaning the Water Reservoir

It is normal over time for discoloration, spotting or staining to appear in the water reservoir. Results will vary depending on the mineral content of the bottled or filtered water used but will not affect the operation of the machine. However, be sure to clean the water reservoir regularly to minimize build-up.

Clean inside the water reservoir with a damp, lint-free cloth as necessary.

Decalcification

Mineral content in water varies from place to place. Depending on the mineral content of the water in your area, calcium deposits or

scale may build up in your machine. Though scale is non-toxic, it can hinder performance. De-scaling the machine will help maintain the heating element and other parts that come in contact with water.

For optimal performance, de-scale your machine every 3 to 6 months. It is possible for calcium to build up faster, making it necessary to de-scale more often.

To begin, you will need the following:

- 10 ounces of distilled white vinegar
- 12-ounce ceramic mug (do not use paper cup)
- Access to sink

Step 1: First Vinegar Rinse

- Fill water reservoir with 10 ounces of undiluted white vinegar.
- Place the ceramic mug on the drip tray.
- Lift the brew head handle, but do NOT add a capsule.
- Close the brew head and press the **MANUAL M** button.
- **M** will illuminate blue while the vinegar is dispensing. Press **M** again to stop it once the mug is halfway full.
- LEDs will start flashing to signal to fill the reservoir.
- Allow the machine to sit for 30 minutes.
- Power on the machine, open and close the brew head, then press **M** to start dispensing. Press **M** again to stop dispensing.
- Discard the contents of the mug into the sink.

Step 2: Fresh Water Rinse

- Repeat step 1 three times using fresh water in place of vinegar.
- This will clean the machine's plumbing and remove any residual vinegar taste. The machine is now ready for normal use.

Maintenance: Any other servicing should be performed by an authorized service representative.

TROUBLESHOOTING

Problem: Machine does not have power.

Solution:

- Plug the machine into an independent outlet.
- Make sure the machine is securely plugged in.
- Reset your home's circuit breaker.
- Confirm the power has been turned on and the controls are illuminated.

Problem: Machine will not brew.

Solution:

- Turn off and unplug the machine for 30 seconds or more. When you plug the machine back in, be sure to turn the power back on.
- Make sure there is water in the reservoir.
- Make sure the reservoir is properly installed.
- Make sure brew head is completely closed.

Problem: Chlorine or mineral taste in coffee.

Solution:

- Consider using bottled or filtered water.

Problem: Doesn't brew a full cup.

Solution:

- Turn off and unplug the machine for 30 seconds or more. When you plug the machine back in, be sure to turn the power back on.
- Decalcify the machine (refer to page 7).

Problem: The used capsule will not fall into the capsule container.

Solution:

- That indicates the capsule container is full. Empty the capsule container and then try again, or manually remove the used capsule in the brew head.

Problem: I want to reset the coffee programming.

Solution:

- See pages 6 and 7 for instructions.

Problem: The control lights are not as bright as they were.

Solution:

- The machine has an energy-saving feature that dims the lights and power by about 50% after 30 minutes of non-use. Restore full power by pressing any button.

Problem: Machine turned off.

Solution:

- The machine's auto-off feature turns the coffeemaker off after 60 minutes of non-use.

Problem: Coffee is not hot enough.

Solution:

- Press the **EXTRA-HOT SETTING** button and wait until the light is steady to brew a hotter cup of coffee.

Problem: SHORT  /LONG  buttons flash quickly; all buttons are non-functional; or some buttons are off.

Solution:

- That indicates the coffee boiler has short-circuited or detects low temperature. Recover the unit by re-powering ON or unplugging and re-plugging.

RECIPES

Steaming/Frothing Instructions	10
Espresso Macchiato	10
Espresso Breve	10
Cappuccino.....	10
Café Latte.....	11
Soy Latte.....	11
Flavored Latte	11
Mochaccino	11
Caffè Mocha	12
Ice Cappuccino.....	12
Frozen Latte	12
Espresso Shake	13
Espresso Martini	13
Caffè Coretto.....	13
Granita.....	13
Affogato.....	14
Espresso Gelato.....	14
Tiramisù.....	14
Ham Steak with Red-Eye Gravy.....	15
Espresso-Marinated Flank Steak	15

Steaming/Frothing Instructions

When steaming milk at home for delicious coffee-based drinks, always start with fresh, cold milk and steam only what you are going to use right away. For best results, we prefer using non-fat or skim milk, which produces light, voluminous foam, but feel free to experiment. Keep in mind that the consistency of the foam will vary depending on what type of milk is used. It is always best to froth your milk right before serving.

To steam and froth milk at home:

Fill a small to medium saucepan, no more than halfway, with cold milk and place over medium heat. Heat the milk until steam begins rising off the surface, but no bubbles have formed. Remove the pan from the heat and using a frother or immersion blender on low speed, process milk until the desired amount of froth is produced. If you do not own an immersion blender, you can whip the milk by hand with a wire whisk, but be ready to put some effort into it! Pour the milk into your espresso or coffee, using a spoon to hold back the foam. Scoop foam on top and serve.

Alternately, if using a microwave, pour milk into microwave safe mug or container and heat until steam begins to rise off the milk's surface (be careful milk does not boil over). Carefully remove from microwave and froth milk as described above.

Espresso Macchiato

A simple spot of foam makes this drink a classic.

Makes 1 serving

1 illy iperEspresso capsule

1 tablespoon frothed milk

1. Place an espresso cup on the espresso cup tray.
2. Using the lever, open the brew head, insert the capsule and close the brew head. Press Short  to start the brewing process.
3. When the brewing process is complete, use a large spoon to place one tablespoon of the foam on top of the espresso.
4. Serve immediately.

Espresso Breve

American version of a latte – substituting half & half for milk.

Makes 1 serving

1 illy iperEspresso capsule

¾ to 1 cup steamed half & half

1. Place a mug on the latte/cappuccino tray.
2. Using the lever, open the brew head, insert the capsule and close the brew head. Press the Short  button to start the brewing process.
3. When the brewing process is complete, pour the cream into the espresso and serve immediately.

Cappuccino

A thick layer of foam and bit of milk let the boldness of the coffee shine through in this popular drink.

Makes 1 serving

1 illy iperEspresso capsule

½ cup steamed and frothed skim milk

1. Place a mug on the latte/cappuccino tray.
2. Using the lever, open the brew head, insert the capsule and close the brew head. Press the Short  button to start the brewing process.
3. When the brewing process is complete, pour the milk into the espresso and top with 2 to 3 tablespoons of foam. Serve immediately.

Café Latte

Similar to a cappuccino, this drink contains more milk, which makes it creamy.

Makes 1 serving

- 1 illy iperEspresso capsule**
 - 1 cup steamed and frothed skim milk**
1. Put a mug on the latte/cappuccino tray.
 2. Using the lever, open the brew head, insert the capsule and close the brew head. Press the Short **VP** button to start the brewing process.
 3. When the brewing process is complete, slowly pour the steamed milk into the espresso. Top with foam and serve immediately.

Soy Latte

This is a delicious non-dairy alternative.

Makes 1 serving

- 1 illy iperEspresso capsule**
 - 1 cup steamed and frothed soy milk**
1. Put a mug on the latte/cappuccino tray.
 2. Using the lever, open the brew head, insert the capsule and close the brew head. Using the lever, open the brew head, insert the capsule and close the brew head. Press the Short **VP** button to start the brewing process.
 3. When the brewing process is complete, slowly pour the steamed milk into the espresso and top with a bit of the foam. Serve immediately.

Flavored Latte

Any type of flavored syrup can be used in this recipe.

Makes 1 serving

- 1 tablespoon flavored syrup**
 - 1 illy iperEspresso capsule**
 - 1 cup steamed and frothed skim milk**
1. Put the syrup into a mug and place on the latte/cappuccino tray.
 2. Using the lever, open the brew head, insert the capsule and close the brew head. Press the Short **VP** button to start the brewing process.
 3. When the brewing process is complete, slowly pour the steamed milk into the espresso and lightly stir. Top with a bit of the foam and serve immediately.

Mochaccino

Chocolate cappuccino – what could be better?!

Makes 1 serving

- 2 tablespoons chocolate syrup**
 - 1 illy iperEspresso capsule**
 - ½ cup steamed and frothed skim milk**
 - 1 teaspoon shaved bittersweet chocolate or unsweetened cocoa powder (for garnish)**
1. Swirl half of the chocolate syrup around the inside of a mug and place on the latte/cappuccino tray.
 2. Using the lever, open the brew head, insert the capsule and close the brew head. Press the Short **VP** button to start the brewing process.
 3. When brewing process is complete stir in the remaining chocolate syrup and a small amount of the steamed milk. Top with a large dollop of foam and sprinkle with the shaved chocolate or cocoa. Serve immediately.

Caffè Mocha

This ultra-rich drink makes a perfect ending to any special meal.

Makes 1 serving

- 1 **illy iperEspresso capsule**
- 1 **tablespoon chocolate syrup**
- 1 **cup steamed and frothed skim milk**
- 2 **tablespoons whipped cream**
- 1 **teaspoon shaved bittersweet chocolate or unsweetened cocoa powder (for garnish)**

1. Put a mug on the latte/cappuccino tray.
2. Using the lever, open the brew head, insert the capsule and close the brew head. Press the Short **☑** button to start the brewing process.
3. When brewing process is complete stir in the chocolate syrup and some of the steamed milk. Top with a small amount of foam and then with the whipped cream and chocolate or cocoa. Serve immediately.

Iced Cappuccino

Cool down during the warmer months with this refreshing drink.

Makes 1 serving

- 1 **illy iperEspresso capsule**
- 4 **ice cubes**
- 1/3 **cup whole milk***
- 1/2 **cup cold skim milk**

1. Using the lever, open the brew head, insert the capsule and close the brew head. Press the Short **☑** button to start the brewing process.
2. When the brewing process is complete, set the espresso aside and let cool to at least room temperature. Once cool, put the ice cubes and whole milk into a tall glass. Stir in the espresso.

3. Put skim milk in a small measuring cup or container and froth with an immersion blender, frother, or whisk. Top the cappuccino with the foam and serve immediately.

*Skim milk can be used; however we like the extra richness the whole milk provides for this icy treat.

Frozen Latte

You will never need to go out for coffee when you can make this frosty treat at home.

Makes 3 cups

- 2 **Lungo or Long illy ipEspresso capsules**
- 1 **cup steamed and frothed skim milk**
- 2 **tablespoons granulated sugar**
- 6 **heavy cream ice cubes***
- 6 **ice cubes**

1. Put a mug on the latte/cappuccino tray.
2. Using the lever, open the brew head, insert the capsule and close the brew head. Press the Long **☑** button to start the brewing process.
3. When the brewing process is complete, insert a new capsule into the brew head and press the Long **☑** button. Stir in milk and sugar to dissolve and cool to at least room temperature.
4. Put beverage, cream and regular ice cubes in a Cuisinart® blender jar. Cover and blend on highest speed until smooth, about 1 minute.
5. Serve immediately.

Note: For an iced mocha, add tablespoons of chocolate syrup while blending.

*Pour heavy cream into ice cube trays and freeze overnight.

Espresso Shake

Thick and delicious!

Makes about 3 cups

- 1 cup brewed espresso, chilled**
- 2 cups coffee ice cream**
- 1. Put espresso and ice cream into a Cuisinart® blender jar.
- 2. Cover and blend on lowest speed until smooth, about 1 minute.

Espresso Martini

A delicious cocktail that packs a punch.

Makes 1½ cups, about three ½-cup servings

- 10 ice cubes**
- ½ cup vodka**
- ½ cup brewed espresso, chilled**
- 2 tablespoons Kahlua®**
- 2 tablespoons Tia Maria®**
espresso beans for garnish
- 1. Put the ice cubes, vodka, espresso, Kahlua® and Tia Maria® into a cocktail shaker. Shake really well until fully mixed and chilled.
- 2. Pour equally into 3 martini glasses.
- 3. Add an espresso bean or two in each glass for garnish and serve immediately.

Caffè Coretto

The perfect closer.

Makes 1 serving

- 1 illy iperEspresso capsule**
- 1 ounce Sambuca**
- 1. Put a small espresso cup on the espresso cup tray.
- 2. Using the lever, open the brew head, insert the capsule, close the brew head and press the Long.  Pour the Sambuca into a brandy snifter.
- 3. Serve both espresso and Sambuca together. Pour espresso into Sambuca before drinking.

Granita

A light and simple dessert.

Makes 4 servings

- 4 Lungo or Long illy iperEspresso capsules**
- 2 tablespoons granulated sugar**
- 1 cup whipped cream**
- 1 teaspoon shaved bittersweet or semisweet chocolate for garnish**
- 1. Put a tall 16-ounce glass on the latte/cappuccino or travel cup tray. Using the lever, open the brew head, insert the capsule and close the brew head. Press the Long  button to fill the cup (about a ½ cup.) Continue with remaining capsules.
- 2. Stir sugar into the hot espresso to dissolve and pour mixture into a freezer-safe container. Leave to cool to room temperature.
- 3. Once cool, cover with plastic wrap and place in the freezer. Every hour, for about 5 hours total, scrape the mixture with a fork to allow crystals to form.
- 4. To serve, layer equal amounts of granita and whipped cream in a parfait glass. Garnish with shaved chocolate.

Affogato

Dessert for two. Scoop your ice cream in advance and save in the freezer until ready to serve.

Makes 2 servings

2 scoops vanilla ice cream

2 illy IperEspresso capsule

1. Scoop ice cream into two individual bowls. Put an espresso cup on the espresso cup tray. Have an additional espresso cup ready.
2. Using the lever, open the brew head, insert the capsule, close the brew head and press the Short  button.
3. When the brewing process is complete, repeat, and pour each espresso over the ice cream and serve immediately.

Espresso Gelato

For an extra jolt, add some dark chocolate-covered espresso beans toward the end of freezing.

Makes about 4 cups (eight ½-cup servings)

1 cup heavy cream

2 cups whole milk, divided

1 cup brewed espresso

1 cup granulated sugar

2 tablespoons cornstarch

pinch sea or kosher salt

1 tablespoon liquid pectin

1. In a medium saucepan, combine cream and 1½ cups of the milk. Set over medium/medium-low heat and bring to a simmer.
2. While cream/milk mixture is heating, put the remaining milk, espresso, sugar, cornstarch and salt into a small/medium mixing bowl. Whisk to combine.
3. Once milk/cream mixture comes to a simmer, add the milk/sugar mixture and stir until fully combined. While still set over medium/medium-low heat, stir

continuously until mixture boils and thickens so that it can coat the back of a spoon (this will take about 15 minutes, depending on the stove being used).

4. Remove pan from heat, stir in pectin, strain and cool to room temperature. Cover and refrigerate overnight.
5. Whisk mixture together again before pouring into the ice cream maker. Pour the mixture into the mixing bowl of the Cuisinart® Ice Cream Maker. Mix until thickened, about 30 minutes. The gelato will have a soft, creamy texture. If a firmer consistency is desired, transfer to an airtight container and place in freezer for about 2 hours. Remove from freezer about 15 minutes before serving.

Tiramisù

A simple variation of the Italian classic.

Makes 9 servings

1 container (8 ounces) mascarpone cheese, room temperature

1 cup chilled heavy cream

¼ cup plus 2 tablespoons confectioners' sugar

2 tablespoons plus 1 teaspoon dark rum, divided

1½ cups brewed espresso, cooled

28 Savoiardi (crisp Italian ladyfingers)

¼ cup unsweetened cocoa powder, for garnish

1. Beat the mascarpone in a medium bowl using a Cuisinart® hand mixer until lightened and slightly whipped. In another bowl, whip the heavy cream to soft peaks, adding the confectioners' sugar a little at a time while whipping. Add 1 teaspoon of the rum and whip briefly to incorporate. Gently fold the whipped cream into the mascarpone, ⅓ at a time, until completely incorporated.
2. In a shallow bowl, mix the espresso with the remaining 2 tablespoons of rum.

Working with one ladyfinger at a time, dip the cookie into the espresso, soaking each side for a few seconds, and transfer to 9-inch square baking pan or dish. Repeat with 13 more of the ladyfingers, arranging in the bottom of the dish to cover the entire surface. It should be a tight fit.

3. Evenly spread half of the mascarpone cream over the ladyfingers, covering the entire surface. Dip the remaining ladyfingers and arrange over the cream. Spread an even layer of the remaining mascarpone mixture on top. Cover with plastic wrap and chill for at least 6 hours.
4. Before serving, pour the cocoa powder into a small strainer and dust over the top of the tiramisu.

Ham Steak with Red-Eye Gravy

*A twist on the Southern breakfast staple.
Serve alongside biscuits and grits.*

Makes 2 servings

- 1** **teaspoon oil**
 - 1** **7-ounce smoked ham steak, ¼-inch thick**
 - ½** **cup brewed espresso**
 - 1** **teaspoon granulated sugar**
 - 1** **tablespoon unsalted butter, chilled**
1. Put the oil into a 10-inch skillet and place over medium-high heat. Once the oil is hot and shimmers, add the ham steak. Cook until browned, about 5 to 6 minutes per side. Remove ham to a plate and set aside.
 2. Add the coffee to the skillet and stir with a wooden spoon, scraping up any bits on the bottom of the pan. Stir in the sugar to dissolve. Simmer the coffee until it has reduced by about ⅓ to ½. Right before taking the pan off the heat, swirl in the butter until incorporated. Remove the pan from the heat.
 3. Slice the steak in half and spoon gravy over the top or serve on the side.

Espresso-Marinated Flank Steak

Espresso becomes the star in this easy-to-prepare marinade.

Makes 4 servings

- 1** **cup brewed espresso, cooled**
 - 2** **tablespoons molasses**
 - 2** **tablespoons fresh lemon juice**
 - 1** **tablespoon apple cider vinegar**
 - ¼** **teaspoon ground black pepper**
 - ¼** **teaspoon crushed red pepper**
 - 1** **pound flank steak**
 - 1** **teaspoon kosher salt**
1. Whisk together the espresso, molasses, lemon juice, apple cider vinegar and both peppers in a bowl. Add the flank steak and make sure it is submerged in the marinade. Refrigerate overnight.
 2. Preheat a Cuisinart® Griddler fitted with grill plates in the open position to Sear. When grill is ready, remove as much excess marinade as possible and season with the salt. Grill about 5 to 6 minutes per side for medium rare.
 3. Let steak rest for 5 minutes before slicing and serving.

FULL TWO-YEAR WARRANTY

This warranty is available to consumers only. You are a consumer if you own a Buona Tazza™ Single Serve Espresso Machine that was purchased at retail for personal, family or household use. Except as otherwise required under applicable law, this warranty is not available to retailers or other commercial purchasers or owners. We warrant that your Buona Tazza™ Single Serve Espresso Machine will be free of defects in materials and workmanship under normal home use for 2 years from the date of original purchase.

We recommend that you visit our website, www.cuisinart.com for a fast, efficient way to complete your product registration. However, product registration does not eliminate the need for the consumer to maintain the original proof of purchase in order to obtain the warranty benefits. In the event that you do not have proof of purchase date, the purchase date for purposes of this warranty will be the date of manufacture.

California Residents Only

California law provides that for In-Warranty Service, California residents have the option of returning a nonconforming product (A) to the store where it was purchased or (B) to another retail store that sells Cuisinart products of the same type. The retail store shall then, according to its preference, either repair the product, refer the consumer to an independent repair facility, replace the product, or refund the purchase price less the amount directly attributable to the consumer's prior usage of the product. If either of the above two options does not result in the appropriate relief to the consumer, the consumer may then take the product to an independent repair facility, if service or repair can be economically accomplished. Cuisinart and not the consumer will be responsible for the reasonable cost of such service, repair, replacement, or refund for nonconforming products under warranty. California residents may also, according to their preference, return nonconforming products directly to Cuisinart for repair or, if necessary, replacement by calling our Consumer Service Center toll-free at 1-800-726-0190. Cuisinart will be responsible for the cost of the repair, replacement, and shipping and handling for such nonconforming products under warranty.

BEFORE RETURNING YOUR CUISINART PRODUCT

If your Buona Tazza™ Single Serve Espresso Machine should prove to be defective within the warranty period, we will repair or, if we think necessary, replace it. To obtain warranty service, please call our Consumer Service Center toll-free at 1-800-726-0190 or write to: Cuisinart, 7475 North Glen Harbor Blvd. Glendale, AZ 85307. To facilitate the speed and accuracy of your return, enclose \$10.00 for shipping and handling. (California residents need only supply a proof of purchase and should call 1-800-726-0190 for shipping instructions.) Be sure to include your return address, description of the product's defect, product serial number, and any other information pertinent to the return. Please pay by check or money order. **NOTE:** For added protection and secure handling of any Cuisinart product that is being returned, we recommend you use a traceable, insured delivery service. Cuisinart cannot be held responsible for in-transit damage or for packages that are not delivered to us. Lost and/or damaged products are not covered under warranty.

Your Buona Tazza™ Single Serve Espresso Machine has been manufactured to the strictest specifications and has been designed for use only in 120 volt outlets and only with authorized accessories and replacement parts. This warranty expressly excludes any defects or damages caused by attempted use of this unit with a converter, as well as use with accessories, replacement parts or repair service other than those authorized by Cuisinart. This warranty does not cover any damage caused by accident, misuse, shipment or other than ordinary household use. This warranty excludes all incidental or consequential damages. Some states do not allow the exclusion or limitation of these damages, so these exclusions may not apply to you. You may also have other rights, which vary from state to state.

Important: If the nonconforming product is to be serviced by someone other than Cuisinart's Authorized Service Center, please remind the servicer to call our Consumer Service Center at 1-800-726-0190 to ensure that the problem is properly diagnosed, the product is serviced with the correct parts, and to ensure that the product is still under warranty.

Cuisinart®

SAVOR THE GOOD LIFE®



Food
Processors



Juicers



Coffeemakers



Cookware



Tools and
Gadgets

Cuisinart offers an extensive assortment of top quality products to make life in the kitchen easier than ever. Try some of our other countertop appliances, cookware, tools and gadgets.

www.cuisinart.com

www.cuisinart/esspressomaker.com

©2013 Cuisinart
150 Milford Road
East Windsor, NJ 08520
Printed in China

12CE136856

IB-11868

Any other trademarks or service marks referred to herein are the trademarks or service marks of their respective owners.

Free Manuals Download Website

<http://myh66.com>

<http://usermanuals.us>

<http://www.somanuals.com>

<http://www.4manuals.cc>

<http://www.manual-lib.com>

<http://www.404manual.com>

<http://www.luxmanual.com>

<http://aubethermostatmanual.com>

Golf course search by state

<http://golfingnear.com>

Email search by domain

<http://emailbydomain.com>

Auto manuals search

<http://auto.somanuals.com>

TV manuals search

<http://tv.somanuals.com>