



MOUNT

CANTILEVER SERIES

Installation Guide

Every effort has been made to provide accurate and error-free assembly and installation.

DCS Mount disclaims liability for any difficulties arising from the interpretation of information contained in these instructions.

If DCS Mount products are used for purposes other than their original intent. DCS Mount, its distributors and retailers shall not be held responsible or liable for injuries or property damage, direct indirect, or consequential, which may arise from the inability to use this product safely, properly, and in the manner for which it has been designed and manufactured.

Warranty does not apply to products, which have been lost, damaged by misuse, abuse, or accident.

Thank you for choosing DCS Mount

Fly your Flat Panel TV

Illustration for hardware kit

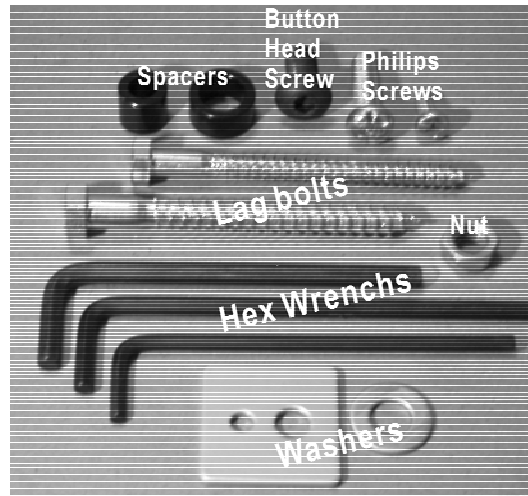

LP-80 Flat Panel Cantilever Mount Installation Instructions

- **80 lb. Maximum weight capacity**
- **VESA 75/100 compliant**
- **Cantilever arm mount for large LCD and small plasma panels**
- **Allows maximum flexibility for installing and viewing displays.**
- **Cantilever arm provides full extension and 180° of lateral rotation for viewing from multiple locations.**
- **Nesting arm design allows display to be folded parallel to wall**
- **Provides full tilt and swivel capabilities for optimum viewing**
- **Durable grey or black powder coat finish**
- **Single stud mounting**

Check the Hardware Kit after open the package

Description	Quantity
3/16 inch Hex Wrench	1
5/32 inch Hex Wrench	1
7/32 inch Hex Wrench	1
5/16 x 3-1/2 inch Lag bolt	2
Philips Screw M5 x 8 mm	4
Philips Screw M5 x 12 mm	4
Philips Screw M4 x 8 mm	4
Philips Screw M4 x 12 mm	4
5/16 Washer	4
Button Head Screw 1/2-20 x 1/2	4

Read through the entire instruction manual before beginning.

This flat panel cantilever will hold larger LCD monitor 30 inches and over. It will also hold smaller plasma monitors up to 32 inches.

First determine if your monitor is VESA standard compliant, refer to the monitor's users manual. VESA is a standard mounting hole pattern (see image 1). The LP-80 Flat Panel Cantilever can attach directly to both 75mm & 100mm VESA square hole patterns. If your monitor is not VESA standard compliant, a mounting adapter bracket will be needed between your monitor and the cantilever mount. Contact your dealer or contact DCS Mount to find out if an adapter is available for your monitor. All plasma will require an adapter bracket. You will need someone to help with this installation.

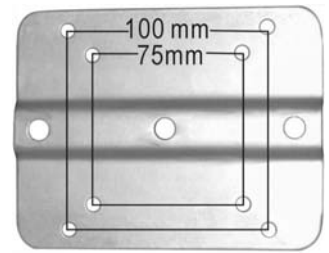

Image 1

1. Determine your preferred mounting location keeping in mind good viewing angles and that this mount **MUST BE PROPERLY SECURED TO THE CENTER OF A STUD.**
2. While holding the mount in place and being sure that the mount is plumb, mark the mounting location (you can use the supplied lag bolts to poke marks into the mounting surface through the center of each mounting hole on the wall mounting plate). When mounting to a wood stud, drill a 3-1/4 inch deep pilot hole with a 9/32" drill bit through each mark. Attach the cantilever mount to the wall before attaching your monitor to the cantilever's monitor mounting plate.

3. If your monitor has a table stand attached, you will need to remove the stand before attaching it to the cantilever mount; refer to the monitor's users manual for proper instruction to remove the stand. In the hardware kit, there are 4 sets of screws with 4 screws per set supplied. Depending on your monitor's manufacture's specifications, determine the proper diameter & length of screws that you will need. **CAUTION: Damage to your monitor's internal components can occur if you use screws that are too long.** Attach your monitor to the VESA plate using the proper screws, **DO NOT over tighten the screws that attaché to the monitor, DAMAGE to the monitor may occur.** If your monitor needs an adapter bracket, use the supplied 1/4-20 screws to attaché the bracket, once it has been mounted to your monitor, to the 100mm pattern on the VESA plate.

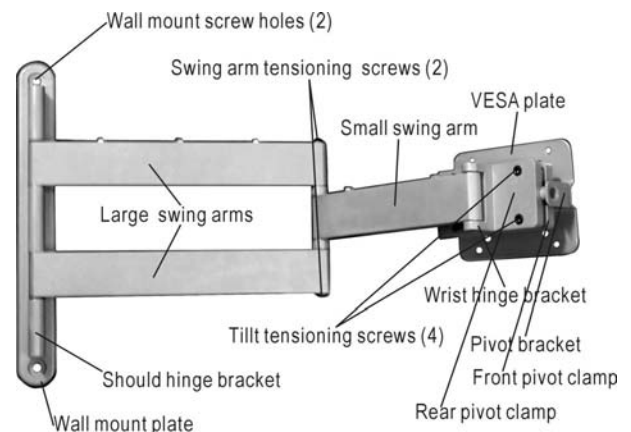

Image 2

4. If you attach any wires along the cantilever's swing arms (for example using P-CLIPS), be sure that the wires (or P-clips) are not pulled, pinched or kinked between the swing arms when you move the cantilever mount around into different positions.

5. All of the screws are properly torqued to specification when the unit is assembled at the factory and should not need an further initial adjustments. However, due to the variety in size of different monitors, MINOR adjustment may be required to optimize the tension needed for ease of movement. **Be sure that your monitor is supported properly while making ANY changes to the cantilever.** To loosen or tighten the 4 screws respectfully on the back of the rear pivot clamp until the desired tension is obtained (see image 2 – Tilt Tensioning Screws and Image 3 – Tensioning Tilt). **It is important to try to maintain even torque on each of the 4 screws.** It does not take that much change in torque to make a large difference in the tilt tension. To loosen or tighten the swing arm tension use the supplied 5/32 inch hex wrench to loosen or tighten the screw shown in image 2 & 3 (Swing Arm Tensioning Screw). Periodic adjustment of these screws may be necessary to maintain desired tension. There should be NO reason to tighten or loosen the wrist hinge bracket. You should need to tighten or loosen the shoulder hinges screws (located top and bottom of hinge), improper tightening of these screws can damage the shoulder hinge bracket and the wall mount plate.

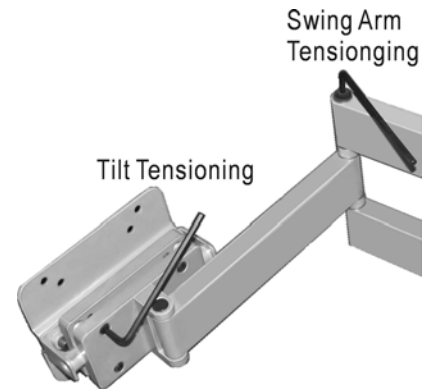
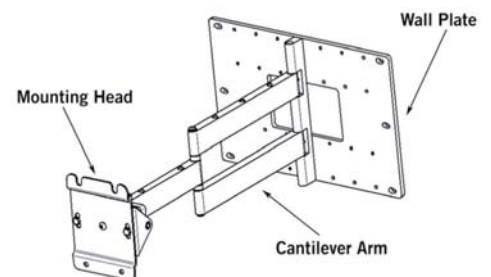

Image 3

P-150 Cantilever Mount Installation Instructions

- **125 lb maximum weight capacity**
- **Cantilever arm mount for large plasma panels**
- **Allows maximum flexibility for installing and viewing displays**
- **Horizontal leveling adjustment (20° range, ±10)**
- **Cantilever arm provides full extension and 180° of lateral rotation for viewing from multiple locations.**
- **Nesting arm design allows display to be folded parallel to wall**
- **Provides full tilt and swivel capabilities for optimum viewing**
- **Quick mount capability with Plad PA-4260**
- **Durable grey or black powder coat finish.**



Check the Hare Ware Kit after open the package

Description	Quantity
3/16 inch Hex Wrench	1
5/32 inch Hex Wrench	1
7/32 inch Hex Wrench	1
3/8 x 3-1/2 inch Lag bolt	6
3/8ID x 13/16OD Washer	6
Button Head Screw 3/8-16 x 1/2	4
Nylon jam nut 3/8-16	4

Read through the entire instruction manual before beginning.

Mounting the Wall Plate

Mounting to Wooden Stud

1. Determine the location where you want the display mounted on the wall.
2. USE stud finder to locate and mark the center of the two studs.
3. Remove P-150 from box. Remove the PA-4260 Adaptor plate from the Mounting Head, and set the four 3/8-16 button head screws aside for later.
4. Remove the cantilever arm from Wall Plate
5. Align center mounting holes of wall plate with center marks on studs. Using the wall plate as a template, mark the mounting holes and center J box hole. Install J box as required.

Note: Electrical outlets should only be installed by a qualified electrician.

6. Drill mounting holes with 9/32 inch bit. Mounting holes should be 3 inch (76mm) deep.

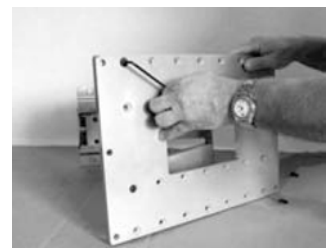
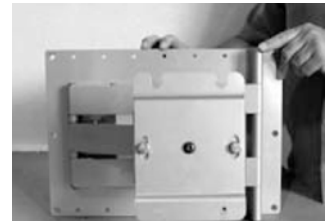

Mounting to Masonry

1. Using the wall plate as a template, mark the mounting holes in the desired mounting location.
2. Drill mounting holes with 3/8" (10mm) masonry bit. Mounting holes should be a minimum of 2-9/16" (65mm) deep.



3. Insert masonry mounting anchors (not supplied) into holes, and tap flash with hammer.

Proceed to Mounting Cantilever Assembly

Mounting Cantilever Assembly

1. **Important:** for the display to be centered over the wall plate when the cantilever arm is folded, the arm will need to be offset by approximately 4" (10.1cm) from the desired center position of the screen. To do this, first note where the desired center of screen position intersects the wall plate, and then mark the all plate.

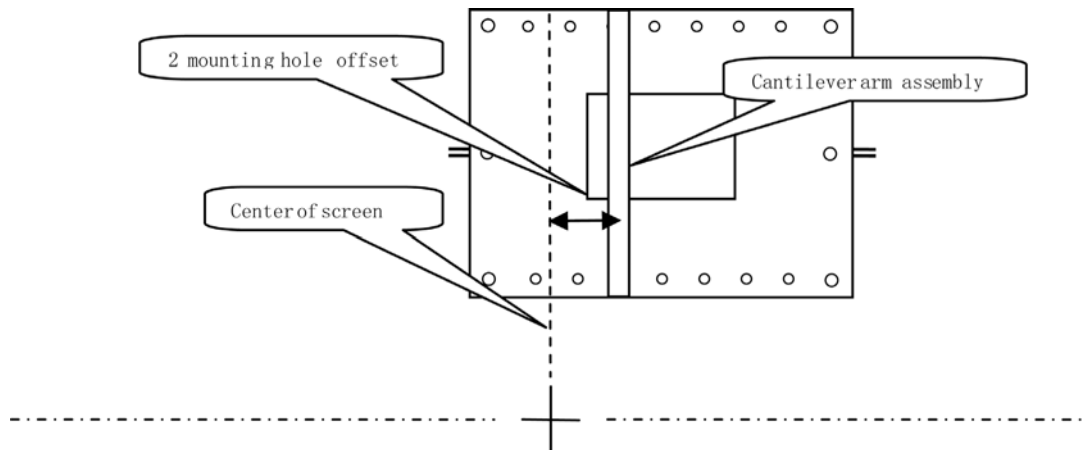

2. Attach cantilever arm to the wall plate at the indicated offset location.

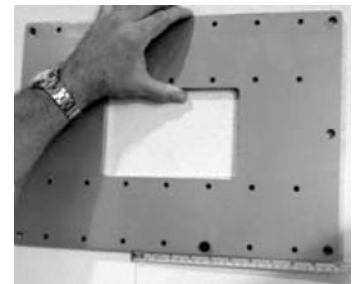

3. Mount cantilever assembly to wall using supplied 3/8" lag bolts.

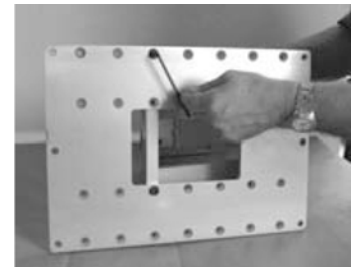

4. Fold cantilever arm to verify center location of mounting head.

Note: the mounting head will be centered with the arm folded in one direction only.

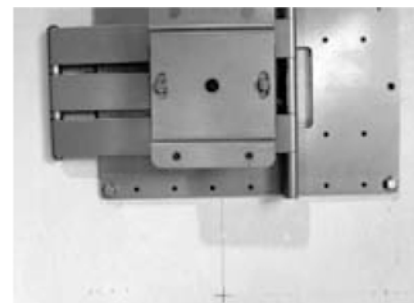

Configuring the PA-4260 adaptor plate (Installation instructions)

PA-4260 Universal Plasma TV Adaptor Installation Instructions

- Fully adjustable design fits most large flat panel displays
- Includes complete hardware kit
- Quick mount capability with P-150
- Durable grey or black powder coat finish

Check the Hardware Kit after open the package

ID*	Description	Quantity
N/A	Button Head Screw 1/4-20 x 1/2	14
N/A	Washer 1/4 ID X 1/2 OD	4
N/A	Nylon jam nut 2/4-20	4
A	Button Head Screw 1/4-20 x 1/2	8
B	Square Washer	8
C	Spacer (0.3ID) 9/16 x 1/2 Length	8
D	Spacer 3/4OD x 3/8 Length	8
E	Spacer (0.42 ID) 5/8 x 1 Length	8
F	5/32 Hex Wrench (Allen)	1
G	Philips Screw M4 x 16 mm	8
H	Philips Screw M4 x 25 mm	6
I	Philips Screw M4 x 45 mm	8
J	Philips Screw M5 x 15 mm	8
K	Philips Screw M5 x 45 mm	8
L	Philips Screw M6 x 16 mm	8
M	Philips Screw M8 x 16 mm	6
N	Philips Screw M8 x 1.25 x 20	6
O	Philips Screw M8 x 25 mm	8
P	Philips Screw M8 x 35 mm	6
R	Philips Screw M8 x 45 mm	4

*** ID in Hardware Cross Reference List: Particular set of spacers and Fasteners may required for some Flat Screen TV need, select the right ID for your display.**

Measure display

The PA-4260 Ships with a standard set of mounting rails pre-installed. These rails will fit a display where the vertical distance between mounting lands on the display are 17 1/8" or less. If your display is larger than this, you will need to install the large set of mounting rails, which are included with the PA-4260. Please see **Install Mounting Rails** at the end of this section for details.

Set PA-4260 width

The PA-4260 is capable of handling a wide range of landed insert widths. Measure the horizontal distance between mounting lands on your display, and set the width of the Mounting Rails as shown, Standard Range: 38 1/2" (98 cm) to 15 3/4" (40 cm)

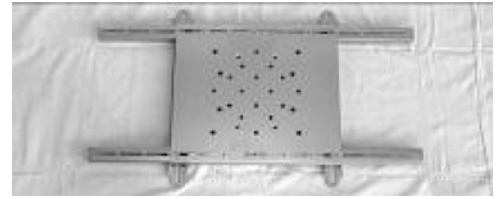

Standard Configuration

For standard range configurations, loosen the screws on the sliders using the supplied Hex Wrench; adjust rails to desired width, and then re-tighten screws.

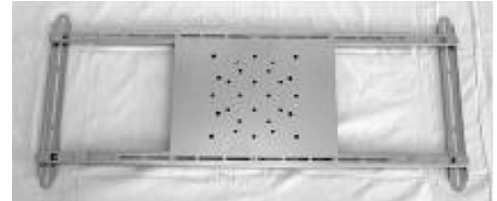

Narrow Range: 15 1/2" (39 cm) to 3 1/2" (9 cm)

Narrow Configuration

For narrow range configurations, flip slider/rail assembly over (as shown below) before inserting them into the channels.

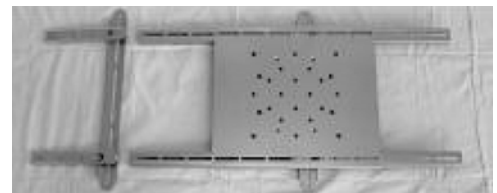

Secure Sliders and back plate

Secure sliders with (8) button head screws. For medium and narrow displays, where the nuts on the slider are beneath the back plate, thread button head screws through the back plate and into the slider as shown.



Note: The outer corners of the back plate must always be secured with a screw. For wide displays, where the nuts on the slider are positioned outside of the back plate, use Nylon jam nuts with button head screws (supplied) to secure the back plate, as shown.

Mount PA-4260 to Display

Hardware Selection

- Consult the supplied Hardware Cross Reference list.
- Select the mounting hardware for your display.

Attach PA-4260 to Display

- Position the PA-4260 over back of display.
- Thread mounting screws through square washers and spacers (if required), as shown.
- Thread mounting screws through slots on side rails into landed inserts, and secure loosely.
- With mounting screws installed, center PA-4260 on the back of the display, and then tighten all screw securely.

CAUTION: Do not use power tools or over-tighten the mounting screws.

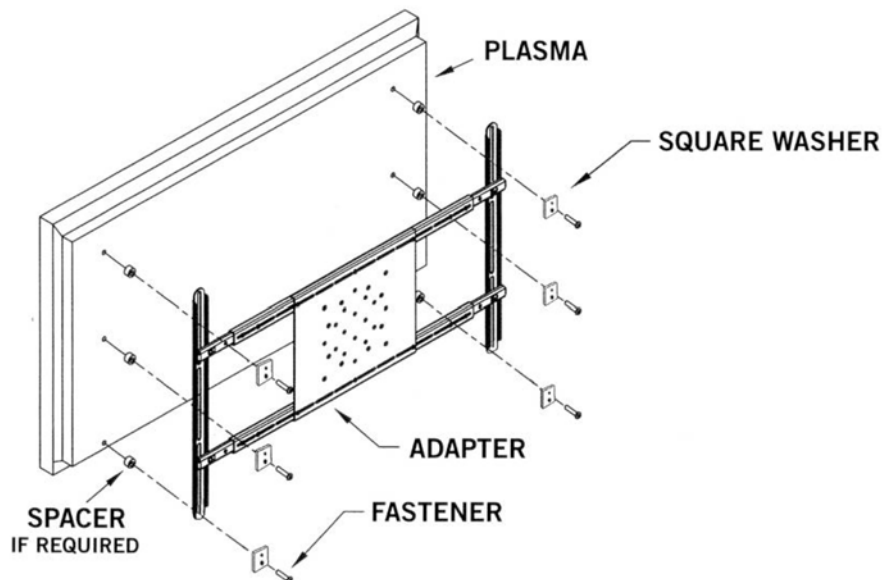

Install Mounting Rails

- Remove slider retaining screws as shown.
- Remove sliders from channels.
- Select required side size: Medium rail- up to 17 1/8" height of landed inserts Large rail- up to 25" height of landed inserts.
- Attach selected side rails to sliders as shown.

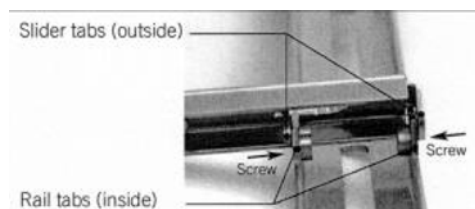
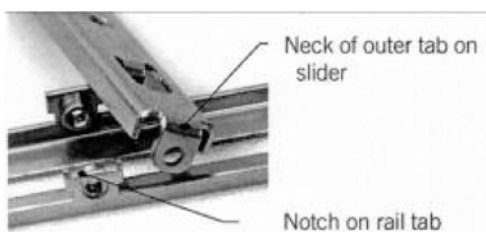
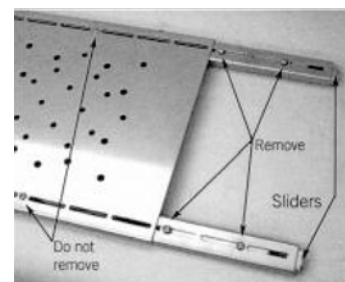

- Re-install slider assemblies into channels as shown, and return to **Set PA-4260 Width** section.

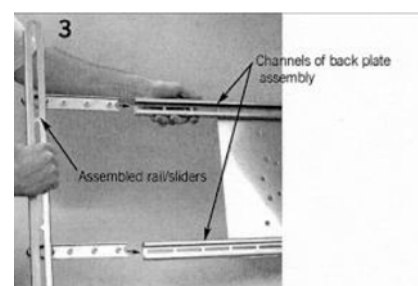

Mounting the display

1. Locate the set of four 3/8"-16 button head cap screws removed at the beginning of the installation.
2. Thread two of the screws approximately a 1/4" (0.6cm) into the upper set of PEM nuts on the adaptor plate, as shown
3. With the help of an assistant, carefully lift the display and hang it onto the P-150 by dropping the exposed portion of the screws down into the key slots on the nose piece of the P-150.
4. With the display hanging on the mount, thread the second set of screw into place, and then tighten all four screws securely.

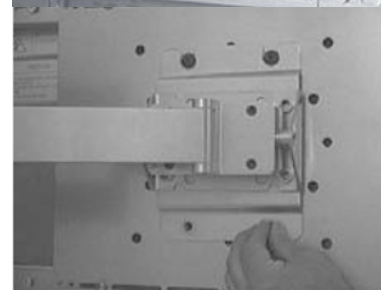

Display Adjustments

Roll Control

Function – Horizontal leveling of the display.

Operation – Grasp the sides of the display, and roll it into the desired position.

Adjusting Roll Tension – Roll tension is controlled by the two tension bolts located on the outer edges of the nose piece. Use an open-ended 9/16" wrench to make adjustments to the tension bolts by inserting wrench between the nose piece and the adaptor plate.



Vertical Tilt

Function – raising and lowering the screen edge to improve viewing angle/picture quality.

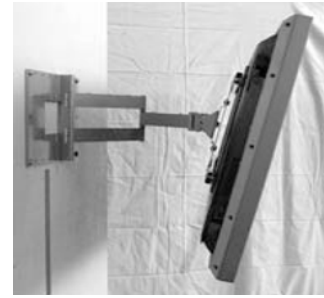

Operation – Loosen tilt tension screws with supplied 3/16" Hex wrench as shown. Adjust display for desired tilt angle. Re-tighten tension screws.

CAUTION :

It is important to try to maintain even torque on each of the 4 screws.

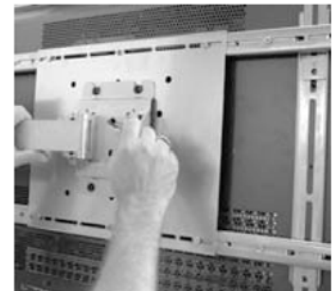

Swivel

Purpose – Optimize viewing angle for off center viewing positions.

Operation – Grasp edges of display and swivel into desired position.

Adjust swivel tension – Adjust tension with supplied 3/16" Hex wrench.

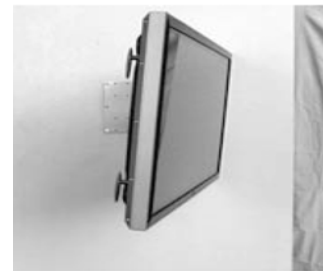

180°Pan

Purpose – Allows display to be positioned perpendicular to wall.

Operation – Extend cantilever arm completely. Fully swivel display in desired direction.

Note: Maximum screen size for full 180°Pan is approximately 50.

Stowing the screen

Purpose – Allows display to be folded flat to the wall.

Operation – Grasp center pivot point of cantilever arm and edge of display. Fold arm in half at pivot point and push display back flat against wall.

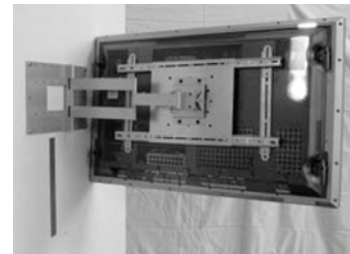

Centering the Screen

The screen will be centered with the cantilever arm folded in one direction only, as shown.



Manufacturer	Model	Spacer	Part ID	Fastener dia x length	Part ID
AKIRA	EPM 420A/B	NONE	N/A	5mm x 15	J
AKIRA	EPM 600	NONE	N/A	8mm x 20*	N
AKAI	PDP4290	NONE	N/A	M8 x 35	P
B & Q	BEOVISION 4	3/4 x 3/8	D	8mm x 35	P
BENQ	PDP46W1	NONE	N/A	6mm x 35	L
DAWOO	DP425M	NONE	N/A	5mm x 15	J
DAWOO	DSP4210	NONE	N/A	5mm x 15	J
DWIN	HD-501	3/4 x 3/8	D	8mm x 35	P
DWIN	HD-50TS	3/4 x 3/8	D	8mm x 35	P
ELECTROGRAPH	DTS42DD	3/4 x 3/8	D	8mm x 35	P
ELECTROGRAPH	DTS4230	NONE	N/A	5mm x 15	J
FAROUDJA	FDP-42HD10	NONE	N/A	5mm x 15	J
FAROUDJA	FDP-50HD10	NONE	N/A	5mm x 15	J
FUJITSU	P42HHA10WS	3/4 x 3/8	D	8mm x 35	P
FUJITSU	P42VCA21	NONE	N/A	8mm x 20	N
FUJITSU	P42HCA11	NONE	N/A	8mm x 20	N
FUJITSU	P50XCA11UH	NONE	N/A	8mm x 20	N
FUJITSU	PDS-4207	NONE	N/A	8mm x 20	N
FUJITSU	PDS-4233	NONE	N/A	8mm x 20	N
FUJITSU	PDS-5002	NONE	N/A	8mm x 20	N
FUJITSU	PDS-5003	NONE	N/A	8mm x 20	N
FUJITSU	PDS-5004	NONE	N/A	8mm x 20	N
FUJITSU	PDS-6101	NONE	N/A	8mm x 20	N
FUJITSU	PDS4208W	NONE	N/A	8mm x 20	N
FUJITSU	PDS-4209	NONE	N/A	8mm x 20	N
FUJITSU	PDS-4210	NONE	N/A	8mm x 20	N
FUJITSU	PDS-4211	NONE	N/A	8mm x 20	N
FUJITSU	PDS-4212	NONE	N/A	8mm x 20	N
FUJITSU	PDS-4213	NONE	N/A	8mm x 20	N
FUJITSU	PDS-4214	NONE	N/A	8mm x 20	N
FUJITSU	PDS-4221	NONE	N/A	8mm x 20	N
FUJITSU	PDS-4222	NONE	N/A	8mm x 20	N
FUJITSU	PDS-4233	NONE	N/A	8mm x 20	N

Manufacturer	Model	Spacer	Part ID	Fastener dia x length	Part ID
HITACHI	50HDT50	NONE	N/A	6mm x 16	L
HITACHI	50HDT55	NONE	N/A	6mm x 16	L
HITACHI	CMP4201	NONE	N/A	6mm x 16	L
HITACHI	CMP4202	NONE	N/A	6mm x 16	L
HITACHI	CMP5000WXV	NONE	N/A	6mm x 16	L
HITACHI	32HDT20	NONE	N/A	6mm x 16	L
HITACHI	42HDT20	NONE	N/A	6mm x 16	L
HITACHI	42HDT50	NONE	N/A	6mm x 16	L
HITACHI	50HDT50	NONE	N/A	6mm x 16	L
JVC	GM-P42UG	NONE	N/A	5mm x 15	J
JVC	PD-42WX84	NONE	N/A	5mm x 15	J
JVC	PD-42WV74	NONE	N/A	5mm x 15	J
MARANTZ	PD-4293D	NONE	N/A	5mm x 15	J
MARANTZ	PD-5020	NONE	N/A	5mm x 15	J
MARANTZ	PD-6120D	DO NOT CANTILEVER			
MITSUBISHI	PD4220	NONE	N/A	5mm x 15	J
MITSUBISHI	PD4230	NONE	N/A	5mm x 15	J
MITSUBISHI	PD5020	NONE	N/A	5mm x 15	J
MITSUBISHI	PD5030	NONE	N/A	5mm x 15	J
MITSUBISHI	PD6120	NONE	N/A	5mm x 15	J
MITSUBISHI	PD6130	NONE	N/A	5mm x 15	J
MITSUBISHI	PD5010	NONE	N/A	5mm x 15	J
MONOVISION	PD46ACS	NONE	N/A	5mm x 15	J
MYRON & DAVIS	AP-42	3/4 x 3/8	d	8mm x 35	P
NEC	42HP82	5/8 x1	E	5mm x 45	K
NEC	PX-42MP1	5/8 x1	E	5mm x 45	K
NEC	PX-42MP2	5/8 x1	E	5mm x 45	K
NEC	PX-42MP3	5/8 x1	E	5mm x 45	K
NEC	PX-42VP2A	5/8 x1	E	5mm x 45	K
NEC	PX-50M5A	5/8 x1	E	5mm x 45	K
NEC	PX50-MP1	5/8 x1	E	5mm x 45	K
NEC	PX-50PD1	5/8 x1	E	5mm x 45	K
NEC	PX-50VP1A	5/8 x1	E	5mm x 45	K
NEC	PX-50XM1A	5/8 x1	E	5mm x 45	K

Manufacturer	Model	Spacer	Part ID	Fastener dia x length	Part ID
NEC	42MP3	NONE	N/A	5mm x 15	J
NEC	42MP4	NONE	N/A	5mm x 15	J
NEC	42VP4A	NONE	N/A	5mm x 15	J
NEC	42VP4D	NONE	N/A	5mm x 15	J
NEC	50XM3A	NONE	N/A	5mm x 15	J
NEC	50MP2	NONE	N/A	5mm x 15	J
NEC	61MP1	DO NOT CANTILEVER		5mm x 15	J
NEC	PD-42XM1	NONE	N/A	5mm x 15	J
NEC	PX-61M1A	DO NOT CANTILEVER		5mm x 15	J
PANASONIC	PT-37PD4	3/4 x 3/8	D	8mm x 35	P
PANASONIC	PT-42PD1-P	3/4 x 3/8	D	8mm x 35	P
PANASONIC	PT-42PD2-P	3/4 x 3/8	D	8mm x 35	P
PANASONIC	PT-42PD3-P	3/4 x 3/8	D	8mm x 35	P
PANASONIC	PT42D4P	3/4 x 3/8	D	8mm x 35	P
PANASONIC	PT-42PHD4	3/4 x 3/8	D	8mm x 35	P
PANASONIC	TH-42PWD3	NONE	N/A	8mm x 45*	R
PANASONIC	TH42PA20U	NONE	N/A	8mm x 45*	R
PANASONIC	TH42PX20U	NONE	N/A	8mm x 45*	R
PANASONIC	TH-42PWD3U	NONE	N/A	8mm x 45*	R
PANASONIC	PT-50PD3-P	3/4 x 3/8	D	8mm x 35	P
PANASONIC	PT-50PHD4	3/4 x 3/8	D	8mm x 35	P
PANASONIC	TH50PHD3U	NONE	N/A	8mm x 45*	R
PANASONIC	50PHW5U2	3/4 x 3/8	D	8mm x 35	P
PANASONIC	FP42HD3P	3/4 x 3/8	D	8mm x 35	P
PANASONIC	FP50HD3P	3/4 x 3/8	D	8mm x 35	P
PANASONIC	FP42HDX63	3/4 x 3/8	D	8mm x 35	P
PANASONIC	FP50HDX63	3/4 x 3/8	D	8mm x 35	P
PANASONIC	PT-37A20UP	3/4 x 3/8	D	8mm x 35	P
PANASONIC	PT-42PD4-P	3/4 x 3/8	D	8mm x 35	P
PANASONIC	PT-42PA20UP	3/4 x 3/8	D	8mm x 35	P
PANASONIC	PT-42PX20UP	3/4 x 3/8	D	8mm x 35	P
PHILIPS	32PF9954	NONE	N/A	5mm x 15	J
PHILIPS	42FD9954	NONE	N/A	5mm x 15	J
PHILIPS	42PF9954	NONE	N/A	5mm x 15	J
PHILIPS	50FD9934	NONE	N/A	5mm x 15	J
PHILIPS	50FD9955	NONE	N/A	5mm x 15	J
PHILIPS	50PF9955	NONE	N/A	5mm x 15	J

Manufacturer	Model	Spacer	Part ID	Fastener dia x length	Part ID
PIONEER	PRO800	NONE	N/A	8mm x 20*	N
PIONEER	PDP-433CMX	NONE	N/A	8mm x 20*	N
PIONEER	PDP-4330HD	NONE	N/A	8mm x 20*	N
PIONEER	PRO1000	NONE	N/A	8mm x 20*	N
PIONEER	PDP-502MX	NONE	N/A	8mm x 20*	N
PIONEER	PDP-5030HD	NONE	N/A	8mm x 20*	N
PIONEER	PDP-4340HD	NONE	N/A	8mm x 20*	N
PIONEER	PDP-503CMX	NONE	N/A	8mm x 20*	N
PIONEER	PDP-503MX	NONE	N/A	8mm x 20*	N
PIONEER	PDP-610CMX	DO NOT CANTILEVER		8mm x 20*	N
PIONEER	PDP-V402	NONE	N/A	8mm x 20*	N
RCA	PHD50400	NONE	N/A	5mm x 15	J
RCA	PHD50500	NONE	N/A	5mm x 15	J
RUNCO	PL-42CX	3/4 x 3/8	D	8mm x 35	P
RUNCO	CW42	NONE	N/A	5mm x 15	J
RUNCO	PL-43HDX	NONE	N/A	8mm x 20	N
RUNCO	PL-50CX	3/4 x 3/8	D	8mm x 35	P
RUNCO	PL-50HDX	NONE	N/A	8mm x 20	N
RUNCO	CW50	NONE	N/A	5mm x 15	J
RUNCO	CW61	DO NOT CANTILEVER		5mm x 15	J
RUNCO	PL-61CX	DO NOT CANTILEVER		5mm x 15	J
RUNCO	PL-61HDX	NONE	N/A	5mm x 15	J
SAMPO	PME-42S6	3/4 x 3/8	D	8mm x 35	P
SAMPO	PME-42X6	3/4 x 3/8	D	8mm x 35	P
SAMPO	PME-42V3	3/4 x 3/8	D	8mm x 35	P
SAMSUNG	PPM4252	3/4 x 3/8	D	8mm x 35	P
SAMSUNG	SPN4235	3/4 x 3/8	D	8mm x 35	P
SAMSUNG	SPL4225K	3/4 x 3/8	D	8mm x 35	P
SAMSUNG	HPL5025K	3/4 x 3/8	D	8mm x 35	P
SAMSUNG	HPN5039	3/4 x 3/8	D	8mm x 35	P
SAMSUNG	SPD-50P2HM	3/4 x 3/8	D	8mm x 35	P
SAMSUNG	SPD-63P1HM	3/4 x 3/8	D	8mm x 35	P
SAMSUNG	PPM63HI	3/4 x 3/8	D	8mm x 25	O
SAMSUNG	HPN5027	3/4 x 3/8	D	8mm x 35	P
SAMSUNG	HPN5039	3/4 x 3/8	D	8mm x 35	P

Manufacturer	Model	Spacer	Part ID	Fastener dia x length	Part ID
SAMSUNG	HPN6339	3/4 x 3/8	D	8mm x 35	P
SAMSUNG	HPM6315	DO NOT CANTILEVER		8mm x 35	P
SAMSUNG	PPM42S3	3/4 x 3/8	D	8mm x 35	P
SAMSUNG	PPM50H3	3/4 x 3/8	D	8mm x 35	P
SAMSUNG	PPM63H3	DO NOT CANTILEVER		8mm x 35	P
SAMSUNG	SPL-4225K	3/4 x 3/8	D	8mm x 35	P
SAMSUNG	SPN-4235	3/4 x 3/8	D	8mm x 35	P
SAMSUNG	SPM-4227	3/4 x 3/8	D	8mm x 35	P
SHARP	PZ-43HV2U	NONE	N/A	8mm x 20	N
SHARP	PZ-50HV2U	NONE	N/A	8mm x 20	N
SONY	KDE42XBR950	NONE	N/A	4mm x 16	G
SONY	KDE50XBR950	NONE	N/A	4mm x 16	G
SONY	KDE61XBR950	DO NOT CANTILEVER		4mm x 16	G
SONY	KE32TS2	9/16 x 1/2	C	4mm x 25	H
SONY	KE42TS2	9/16 x 1/2	C	5mm x 15	J
SONY	KE37XS910	NONE	N/A	5mm x 15	J
SONY	KE42XS910	NONE	N/A	5mm x 15	J
SONY	KE42XBR900	NONE	N/A	5mm x 15	J
SONY	KE42XBR910	NONE	N/A	4mm x 16	G
SONY	KE42XBR950	NONE	N/A	4mm x 16	G
SONY	KE50XBR900	NONE	N/A	5mm x 15	J
SONY	KE50XBR910	NONE	N/A	4mm x 16	G
SONY	KE50XBR950	NONE	N/A	4mm x 16	G
SONY	KLV30XBR900	NONE	N/A	4mm x 16	G
SONY	KZ-32TS1	9/16 x 1/2	C	4mm x 25	H
SONY	KZ-42TS1	5/8 x 1	E	4mm x 45	I
SONY	PFM-32CI	NONE	N/A	4mm x 16	G
SONY	PFM-42B1	NONE	N/A	8mm x 16	M
SONY	PFM-42B2	NONE	N/A	8mm x 16	M
SONY	PFM-50C1	NONE	N/A	8mm x 16	M
SONY	PFM-500A2WU	NONE	N/A	8mm x 16	M
SONY	PFM-510A2WU	NONE	N/A	8mm x 16	M
TOSHIBA	42HP82	NONE	N/A	5mm x 15	J
TOSHIBA	50HP82	NONE	N/A	5mm x 15	J
TOSHIBA	42HP83	NONE	N/A	5mm x 15	J

Manufacturer	Model	Spacer	Part ID	Fastener dia x length	Part ID
YAMAHA	PDM-1	3/4 x 3/8	D	8mm x 35	P
ZENITH	P40B24	NONE	N/A	5mm x 15	J
ZENITH	P42W22B	NONE	N/A	5mm x 15	J
ZENITH	P42W26	NONE	N/A	5mm x 15	J
ZENITH	P42W22BH	NONE	N/A	5mm x 15	J
ZENITH	P60W26	NONE	N/A	8mm x 20	N
ZENITH	P60W26H	DO NOT CANTILEVER		8mm x 20	N
ZENITH	DPDP60W	DO NOT CANTILEVER		8mm x 16	M
ZENITH	P40V22	NONE	N/A	5mm x 15	J
ZENITH	P40V24	NONE	N/A	5mm x 15	J
ZENITH	P42W22B/H	NONE	N/A	5mm x 15	J
ZENITH	P42W24B/P	NONE	N/A	5mm x 15	J
ZENITH	P42W34/34H	NONE	N/A	5mm x 15	J
ZENITH	P42W38	NONE	N/A	5mm x 15	J
ZENITH	P50W26B	NONE	N/A	5mm x 15	J
ZENITH	P50W28B/P	NONE	N/A	5mm x 15	J
ZENITH	P50W38/38H	NONE	N/A	5mm x 15	J
ZENITH	P60W26P	DO NOT CANTILEVER		8mm x 20	N
ZENITH	P60W38/38H	DO NOT CANTILEVER		8mm x 20	N

* may substitute a 8 mm x 60 mm, using a 3/4 x 3/8 spacer

If your Flat Screen TV is not on this list please contact DCS Mount for updated information.

*DCS Mount is not responsible for changes or errors in manufacturer's specifications.

Free Manuals Download Website

<http://myh66.com>

<http://usermanuals.us>

<http://www.somanuals.com>

<http://www.4manuals.cc>

<http://www.manual-lib.com>

<http://www.404manual.com>

<http://www.luxmanual.com>

<http://aubethermostatmanual.com>

Golf course search by state

<http://golfingnear.com>

Email search by domain

<http://emailbydomain.com>

Auto manuals search

<http://auto.somanuals.com>

TV manuals search

<http://tv.somanuals.com>