

DAEWOO

INSTRUCTION MANUAL

Color Television

DTQ 25S5FC

DTQ 27S5FC



CAUTION
RISK OF ELECTRIC SHOCK
DO NOT OPEN

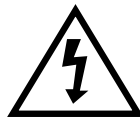

**CAUTION : TO REDUCE THE RISK OF ELECTRIC SHOCK,
DO NOT REMOVE COVER (OR BACK)
NO USER-SERVICEABLE PARTS INSIDE.
REFER SERVICING TO QUALIFIED SERVICE PERSONNEL.**

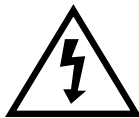

The lightning flash with arrowhead symbol, within an equilateral triangle, is intended to alert the user to the presence of uninsulated “dangerous voltage” within the product’s enclosure that may be of sufficient magnitude to constitute a risk electric shock.



The exclamation point within an equilateral triangle is intended to alert the user to the presence of important operating and servicing instructions in the literature accompanying the appliance.

WARNING

TO REDUCE THE RISK OF FIRE OR SHOCK HAZARD, DO NOT EXPOSE THIS APPLIANCE TO RAIN OR MOISTURE.

CAUTION

CHANGES OR MODIFICATIONS NOT EXPRESSLY APPROVED BY THE MANUFACTURER COULD VOID THE USER’S AUTHORITY TO OPERATE THE EQUIPMENT.

NOTE TO CATV SYSTEM INSTALLER

THIS REMINDER IS PROVIDED TO CALL THE CATV SYSTEM INSTALLER’S ATTENTION TO ARTICLE 820-40 OF THE NEC THAT PROVIDES GUIDELINES FOR PROPER GROUNDING AND, IN PARTICULAR, SPECIFIES THAT THE CABLE GROUND SHALL BE CONNECTED TO THE GROUNDING SYSTEM OF THE BUILDING, AS CLOSE TO THE POINT OF CABLE ENTRY AS PRACTICAL.

CAUTION

The AC power cord provided with this product is polarized (one blade wider than the other).

To prevent electrical shock, match wide blade of plug to wide slot, fully insert the AC plug into a standard 120V~, 60Hz polarized outlet.

NOTE

Never connect the plug to an electrical source other than one providing 120V~, 60Hz power. Use only the attached power cord. If the polarized AC cord does not fit into a non-polarized outlet, do not cut or file the blade. You are responsible for having the obsolete outlet replaced with a polarized outlet.

If you feel a static discharge when touching the unit, and the unit does not function, simply unplug the unit from the outlet. When you plug the unit back in, it should work normally.

Do not install power cords near any heating element or cooking appliances.

IMPORTANT SAFEGUARDS

PLEASE READ ALL THESE INSTRUCTIONS REGARDING YOUR TELEVISION EQUIPMENT AND RETAIN FOR FUTURE REFERENCE. FOLLOW ALL WARNINGS AND INSTRUCTIONS MARKED ON THE TV RECEIVER.

- 1 Read all of these instructions.
- 2 Save these instructions for later use.
- 3 Unplug this television equipment from the wall outlet before cleaning. Do not use liquid cleaners or aerosol cleaners. Use a damp cloth for cleaning.
- 4 Do not use attachments not recommended by the television equipment manufacturer as they may result in the risk of fire, electric shock or other personal injury.
- 5 Do not use this television equipment near water, for example, near a bathtub, washbowl, kitchen sink, or laundry tub, in a wet basement, or near a swimming pool, or the like.
- 6 Do not place this television equipment on an unstable cart, stand, or table. The television equipment may fall, causing serious injury to a child or adult, and serious damage to the equipment. Use only with a cart or stand recommended by the manufacturer, or sold with the television equipment. Wall or shelf mounting should follow the manufacturer's instructions, and should use a mounting kit approved by the manufacturer.
- 6A An appliance and cart combination should be moved with care. Quick stops, excessive force, and uneven surfaces may cause the appliance and cart combination to overturn.
- 7 Slots and openings in the cabinet and the back or bottom are provided for ventilation and to ensure reliable operation of the television equipment; and to protect it from overheating, these openings, must not be blocked or covered. The openings should never be blocked by placing the television equipment on a bed, sofa, rug, or other similar surface. (This equipment should never be placed near or over a radiator or heat register.) This television equipment should not be placed in a built-in installation, such as a bookcase, unless proper ventilation is provided.
- 8 This television equipment should be operated only from the type of power source indicated on the marking label. If you are not sure of the type of power supplied to your home, consult your television dealer or local power company.
- 9 This television equipment is equipped with a polarized alternating current line plug (a plug having one blade wider than the other). This plug will fit into the power outlet only one way. This is a safety feature. If you are unable to insert the plug fully into the outlet, try reversing the plug. If the plug should still fail to fit, contact your electrician to replace your obsolete outlet. Do not defeat the safety purpose of the polarized plug.
- 10 Do not allow anything to rest on the power cord. Do not locate this television equipment where the cord will be abused by persons walking on it.
- 11 Follow all warnings and instructions marked on the television equipment.
- 12 For added protection for this television equipment during a lightning storm, or when it is left unattended and unused for long periods of time, unplug it from the wall outlet and disconnect the antenna or cable system. This will prevent damage to the equipment due to lightning and power-line surges.



- 13** An outside antenna system should not be located in the vicinity of overhead power lines or other electric light or power circuits, or where it can fall into such power lines or circuits. When installing an outside antenna system, extreme care should be taken to keep from touching such power lines or circuits, as contact with them might be fatal.
- 14** Do not overload wall outlets and extension cords, as this can result in fire or electric shock.
- 15** Never push objects of any kind into this television equipment through openings, as they may touch dangerous voltage points or short-out parts that could result in a fire or electric shock. Never spill liquid of any kind on the television equipment.
- 16** Do not attempt to service this television equipment yourself, as opening or removing covers may expose you to dangerous voltage or other hazards. Refer all servicing to qualified service personnel.
- 17** Unplug this television equipment from the wall outlet and refer servicing to qualified service personnel under the following conditions:
- When the power-supply cord or plug is damaged or frayed.
 - If liquid has been spilled, or objects have fallen into the television equipment.
 - If the television equipment has been exposed to rain or water.
 - If the television equipment does not operate normally by following the operating instructions. Adjust only those controls that are covered by the operating instructions as an improper adjustment of other controls may result in damage and will often require extensive work by a qualified technician to restore the TV receiver to its normal operation.
- (e) If the television equipment has been dropped or the cabinet has been damaged.
- (f) When the television equipment exhibits a distinct change in performance - this indicates a need for service.
- 18** When replacement parts are required, be sure the service technician has used replacement parts specified by the manufacturer that have the same characteristics as the original part. Unauthorized substitutions may result in fire, electric shock or other hazards.
- 19** Upon completion of any service or repairs to this television equipment, ask the service technician to perform safety checks to determine that the television is in a safe operating condition.
- 20** If an outside antenna or cable system is connected to the television receiver, be sure the antenna or cable system is grounded so as to provide some protection against voltage surges and built-up static charges.

Section 810 of the National Electrical Code, ANSI/NFPA N0.70-1984, provides information with respect to proper grounding of the mast and supporting structure, grounding of the lead-in wire to an antenna discharge unit, size of grounding conductors, location of antenna-discharge unit, connection to grounding electrodes, and requirements for the grounding electrode.

EXAMPLE OF ANTENNA GROUNDING

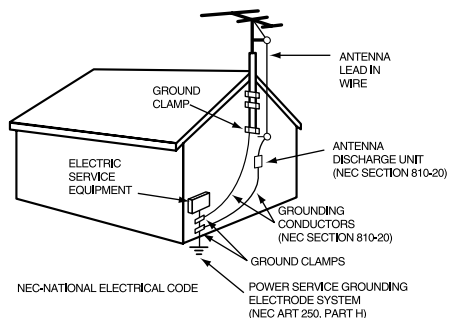

**Daewoo Electronics
Corporation of America**

120 Chubb Avenue,
Lyndhurst, NJ 07071

Dear Customer :

Daewoo Electronics Corporation of America would like to thank you for choosing this color television receiver. It incorporates a host of features designed to give you excellent performance for many years to come.

We realize that you're eager to turn it on and begin enjoying the high-quality pictures it delivers just as quickly as possible, but we ask you to take a few minutes to read the instructions in the booklet to familiarize yourself with the receiver, its functions and some features which may be new to you. If you follow the instructions, this unit should give you many years of viewing pleasure.

If for any reason it does not, we want to hear about it. Please write to us at the address above. Daewoo always welcomes comments and suggestions on this or any of our other products.

On the other hand, when you discover the enjoyment, reliability and ease of use that is built into it, we hope that you will tell your friends, and consider Daewoo when you make your next purchase of home entertainment equipment.

In addition to TV receivers, Daewoo produces a full line of audiovisual products built to the same high design, engineering, and manufacturing standards as this unit.

Here are a few tips that will keep your TV receiver looking great and performing for years to come.

- Avoid putting it in excessively hot locations. Damage to the cabinet or premature component failures can result.
- There are ventilation holes in the bottom and rear of the cabinet. Make sure that they remain unobstructed. Do not place the receiver on top of a thick cloth.
- If you don't plan to use the receiver for several days, it's a good idea to unplug it from the power outlet.
- Many common household cleaning agents, sprays, solvents, and polishes will cause permanent damage to the surface of the cabinet. The best cleaning agents are mild soap and a damp cloth.

Again, thank you for choosing this Daewoo product. We have employed advanced engineering techniques in its design, and manufactured it in one of the world's most up-to-date production facilities. The result is a TV receiver that we know you will be as proud to own as we were to create.

Very truly yours,
DAEWOO ELECTRONICS
CORPORATION OF AMERICA

Table of Contents

Chapter 1: Overview of Your Equipment2

Your TV's Front Panel2

Your TV's Back Panel3

Your Remote Control4

 Installing your remote control batteries5

 Notes5

Chapter 2: Connecting an Antenna or Cable to Your TV6

Connecting an Antenna6

Connecting a Cable System7

Connecting Other Pieces of Equipment8

Safety Note8

Chapter 3: Operating Your TV9

Turning your TV On9

Programming Your TV's Channel Memory9

Changing Channels10

Changing the Volume10

Changing The TV's Channel Memory11

 Adding/Deleting a channel to memory11

Displaying the Current Channel11

Changing the TV's Input12

Adjusting Video Settings13

 Returning to the factory settings14

 Descriptions of video settings14

Chapter 4: Using Timer Functions15

Setting the Clock15

Setting the Wake-up Time15

Setting the Off Time16

Canceling the Wake-up Time or Off Time16

Setting the Sleep Timer17

Chapter 5 : Using the Special Features 18

Changing the Language of the On-Screen Menus18

Captioning18

CC on Mute19

Power Restore19

Parental Control Settings, Description of Parental Control Settings20~21

Ch Labels23

Chapter 6 : Adjusting the Sound25

Selecting stereo/SAP25

Adjusting the Bass26

Adjusting the Treble27

Chapter 7 : Troubleshooting28

Warranty29

Overview of Your Equipment

Your TV comes with a remote control. The section below summarizes the buttons, controls, and terminals that you will use with your TV.

Your TV's Front Panel

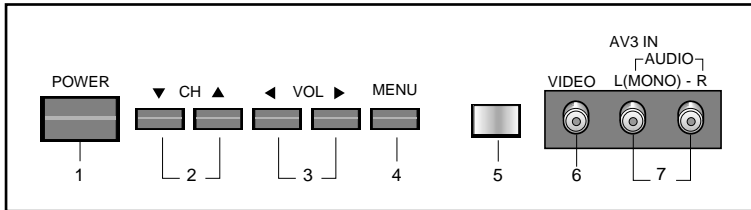

1 POWER

Use this button to turn your TV on or off.

2 ▼CH▲

Use these buttons to change channels on your TV, or to select items in the menu system.

3 ◀VOL▶

Use these buttons to change your TV's volume, to activate selections in the menu system, or to change audio and video settings.

4 MENU

Use this button to turn the TV's menu system on and off.

5 Remote control receiver

This receiver receives a signal from your remote control. Do not block it.

6 VIDEO IN jack

Use this jack to receive a video signal from another A/V component.

7 AUDIO IN jack

This receiver uses this jack to receive an audio signal from another A/V component.

Your TV's Back Panel

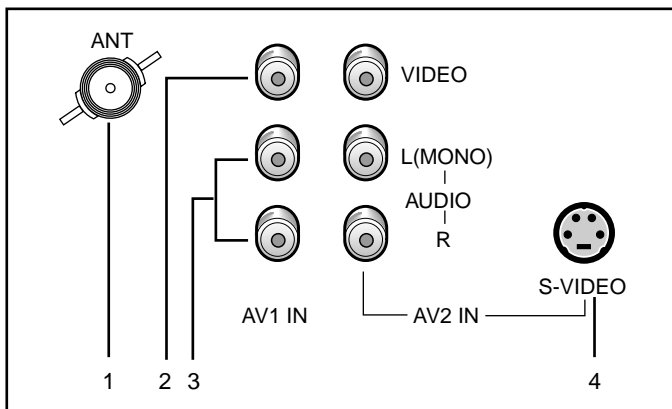

1 Antenna terminal(ANT)

Use this terminal to attach an antenna or cable system to your TV.

2 VIDEO IN

This terminal allows the TV to receive a video signal from another component, such as a VCR.

3 AUDIO IN

This terminal allows the TV to receive an audio signal from another component, such as a VCR.

4 S-VIDEO IN

This terminal allows the TV to receive a S-VIDEO(S-VHS) signal from S-VIDEO(S-VHS) output terminal of another component.

Your Remote Control

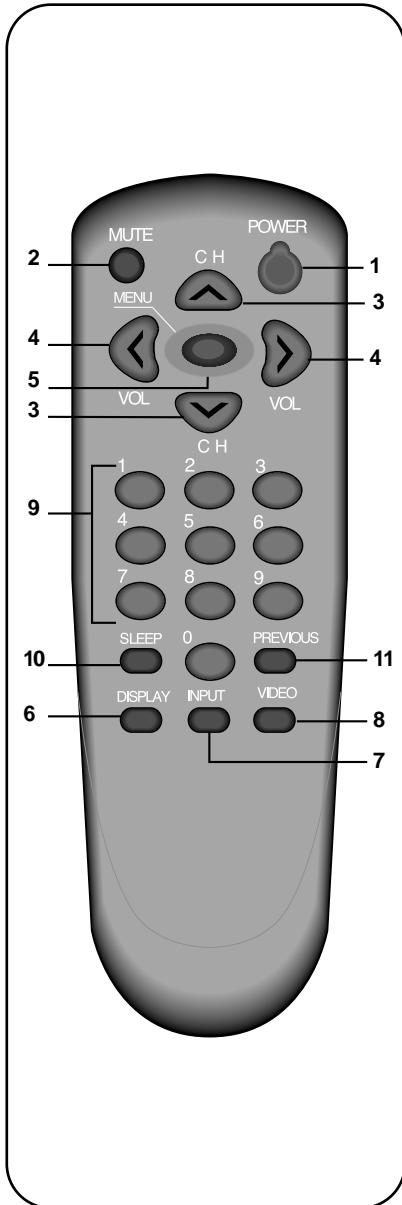

- 1. POWER**
Use this button to turn your TV on or off.
- 2. MUTE**
Use to turn the TV's sound on and off.
- 3. ▼CH▲**
Use these buttons to change channels on your TV, or select items in the menu system.
- 4. ◀VOL▶**
Use these buttons to change your TV's volume, to activate selections in the menu system, or to change audio and video settings.
- 5. MENU**
Use this button to turn the TV's menu system on and off.
- 6. DISPLAY**
Use this button to display the channel number and status.
- 7. INPUT**
Use this button to select the TV's signal source.
- 8. VIDEO**
Use this button to display video adjustment items.
- 9. 0-9**
Use these buttons to change channels.
- 10. SLEEP**
Use this button to program the TV to turn off after a certain time.
- 11. PREVIOUS**
Use this button to return to the previous channel you were watching.

Installing your remote control batteries

- 1 Open the battery compartment on the back of the remote control.
- 2 Install two AA-size batteries (not included) as shown. Make sure the “+” and “-” terminals are oriented correctly.
- 3 Replace the cover.

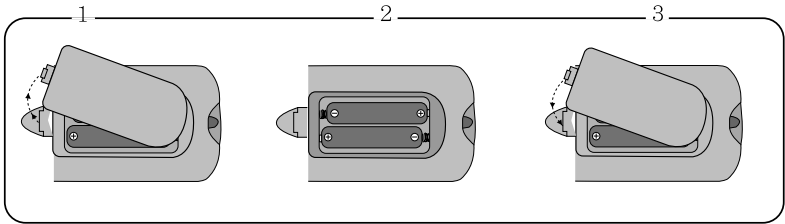

Notes

Do not mix different types of batteries, or mix an old and a new battery.

Remove and replace weak batteries. Weak batteries can leak and damage your controller. Dispose of batteries properly; never throw them into a fire.

Point your remote at the receiver on the center of the front of the TV. Make sure the receiver is not blocked.

The remote control can operate up to 30 feet away from the TV, if you are directly facing the front of the TV. Operating distance diminishes as you move to the sides of the TV.

Connecting an Antenna or Cable to Your TV

Your TV will provide you with the best performance if you connect it to an external antenna or cable system. Follow the directions below make this connection. Please note that you will normally only have to make one of the connections shown below, not all of them.

All connections will be made to the antenna terminal on the back of your TV. The antenna terminal is a silver metal post partially surrounded by two plastic tabs. For help in locating the antenna terminal, see “Your TV’s Back Panel” on page 3.

Connecting an Antenna

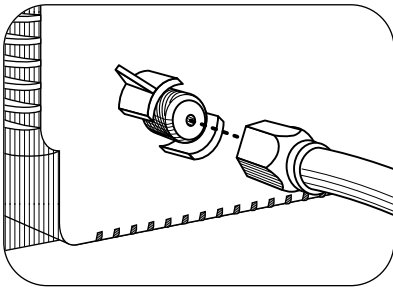

If your antenna ends in a single coaxial lead, simply press or screw the cable onto the antenna terminal on the back of your TV.

If your antenna ends in a pair of 300 ohm twin leads, you must use a 300-ohm/75-ohm adapter (available at your local electronics store). Place the leads underneath the screws on the adapter, tighten the screws, then press the adapter onto the antenna terminal on the back of the TV.

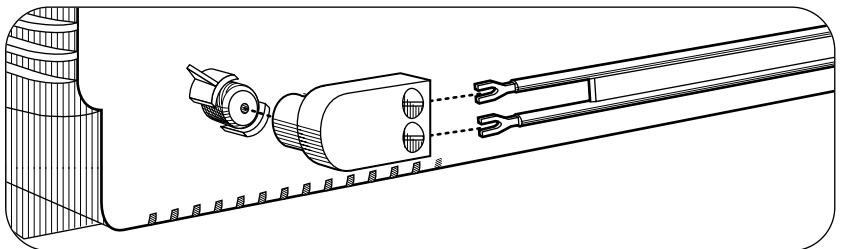

Antennas with two sets of leads

You might have two sets of leads from your antenna system, especially if you have one antenna for VHF signals and one antenna for UHF signals.

If your antenna system has both a coaxial lead and twin 300-ohm leads, you must obtain a combiner (available at your local electronics store). Press or screw the coaxial lead onto the combiner; place the twin leads underneath the screws on the combiner and tighten the screws. Press the cable from combiner onto the antenna terminal on the back of your TV.

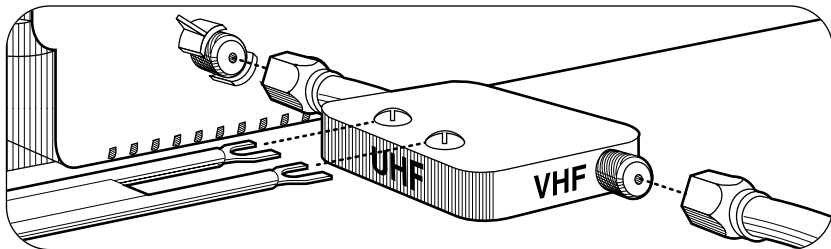

If your antenna system has two sets of twin 300-ohm leads, you must obtain a combiner (available at your local electronics store). Place one set of twin leads underneath the screws on the combiner and tighten the screws. Do the same with the other set of twin leads. Press the cable from the combiner onto antenna terminal on the back of your TV.

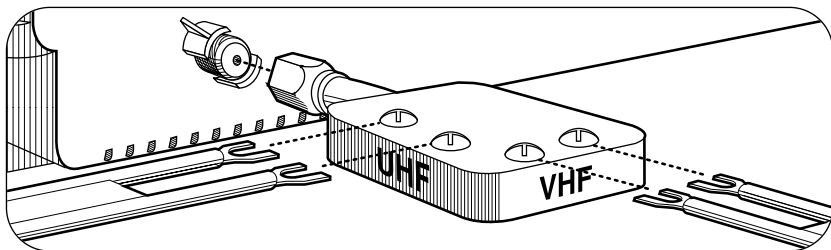

Connecting a cable system

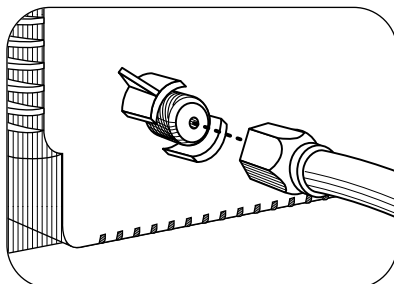

If your cable set-up is not described below, please contact your cable company for more information.

If your cable system does not require the use of a cable box, simply press or screw the incoming cable onto the antenna terminal on the back your TV.

If your cable system requires you to use a converter box for all channels, connect the incoming cable to the IN terminal on the converter box. Connect another cable between the OUT terminal on the converter box and the antenna terminal on the TV. You will need to keep your TV tuned to channel 3 or 4 and change channels using the converter box.

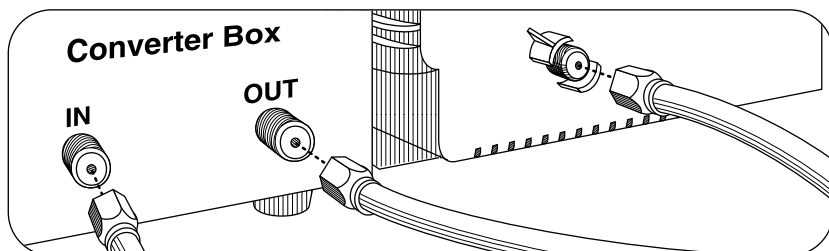

If your cable system only requires you to use a converter box for some channels (i. e. pay-TV channels), follow these steps: Find the primary incoming coaxial cable. Plug this cable into a splitter (available at your local electronics store). Connect one coaxial cable between one OUT terminal on the splitter and the IN terminal on the converter box. Connect another coaxial cable between the other OUT terminal on the splitter and the B-IN terminal on an A/B switch (available at your local electronics store.) Connect a third coaxial cable between the OUT terminal on the converter box and the A-IN terminal on the A/B switch. Finally, connect a coaxial cable between the OUT terminal on the A/B switch and the antenna terminal on the back of your TV.

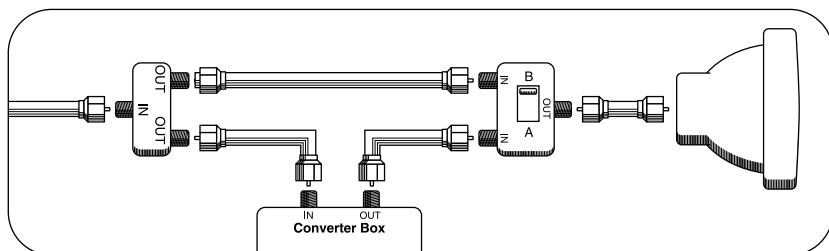

When the A/B switch is in the A position, you need to change channels on the converter box (and your TV should be tuned to channel 3 or 4); when the A/B switch is in the B position you can change channels on the TV.

Connecting Other Pieces of Equipment

You may want to connect a VCR, laser disc player, satellite receiver, or another type of equipment to your TV. We recommend that you follow the instructions included with the piece of equipment you wish to connect.

Safety Note

If you plan on being away from your home for an extended period of time, or if a thunderstorm is approaching, you should unplug your television, and you may wish to disconnect your TV from a rooftop or satellite antenna. You do not need to disconnect your TV from a cable system.

Operating Your TV

Once you have connected your TV to an antenna or cable system, plugged the TV in, and put batteries in the remote, you are ready to use the TV. The first thing you should do is to program your TV so it memorizes all of available channels.

Turning Your TV On

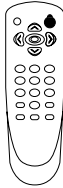

- 1 To turn your TV on, press the POWER button on the remote control. You can also use the POWER button on the front panel. Make sure your TV is plugged in before you try to turn it on.

Programming Your TV's Channel Memory

Your TV's memory determines the channels that are available using the ▼CH▲ buttons. If a channel is not in memory, you can tune to it with the number buttons, but not with the ▼CH▲ buttons. Follow these steps to program your TV's memory:

- 1 With the TV on, press the MENU button twice, then "Set-Up" menu will appear.
- 2 Use the ▼CH▲ buttons to select "Reception", then use the ◀VOL▶ buttons to select 'Air' or 'Cable'. If you connected an antenna to your TV, select 'Air'; If you connected a cable system, select 'Cable'.
- 3 Use the ▼CH▲ buttons to select "Memorize Channels", then use the ◀VOL▶ buttons to enter the "Memorize Channels" process.
- 4 Press the MENU button to return to Set-Up menu.
- 5 Press the MENU button four times to return to normal TV viewing.

Your TV's channel memory will not be affected by a power outage. You will not need to re-program the memory unless you change the type of cable or antenna connected to your TV.

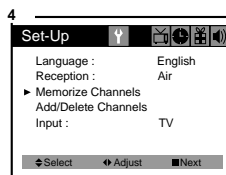
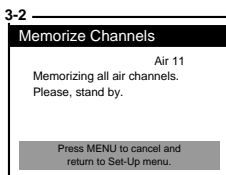
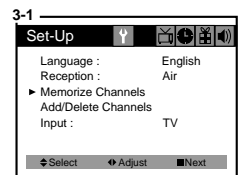
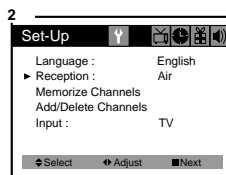
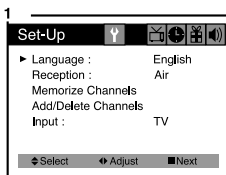

Changing Channels

You can change channels in three ways:

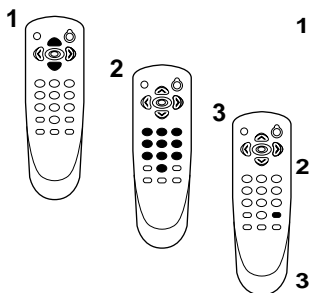

- 1 The **▼CH▲** buttons will take you through all memorized channels, one by one. The **▼CH▲** buttons will not access channels that have not been programmed into the TV's memory. For more information about programming channels into memory, see the section "Programming your TV's Channel Memory" on the previous page.
- 2 The number buttons (0-9) will take you to any channel, even if it has not been memorized. To change to a channel, enter its number; the TV will tune to the new channel when you enter the second digit of the channel.
- 3 The **PREVIOUS** button will take you instantly to the last channel you were watching.

Changing the Volume

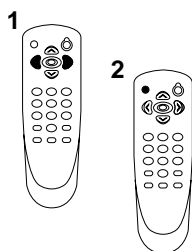

- 1 To change the volume of the TV set, use the **◀VOL▶** buttons on the remote controller or on the front panel.
- 2 To quickly turn off the sound, press the **MUTE** button on the remote. The 'MUTE' will appear on screen, colored green. To return the volume to its previous level, press **MUTE** again.

Changing the TV's Channel Memory

Your TV's memory determines the channels that are available using the **▼CH▲** buttons. You can add channels to this memory or remove them from memory. If a channel is removed from memory, you can tune to it with the number buttons, but you cannot tune to it with the **▼CH▲** buttons.

If there are just one channel memorized, then the Add/Delete Channels function will search the whole channels. But if there are two or more channel memorized, then the Add/Delete Channels function will search the memorized channels only.

Adding/Deleting a channel to memory

- 1 Use the number buttons to tune to the channel.
- 2 Press the MENU button twice, then "Set-Up" menu will display.
- 3 Use the **▼CH▲** buttons to select "Add/Delete Channels", then use the **◀VOL▶** buttons to enter the "Add/Delete Channels" process.
- 4 If the channel is not in memory, then use the **◀VOL▶** buttons to add the channel from memory.
- 5 If the channel is in memory, then use the **◀VOL▶** buttons to delete the channel from memory.
- 6 If you are going to delete other channel, then press the **▼CH▲** buttons until desired channel is selected. And press the **◀VOL▶** buttons to delete the channel.
- 7 Wait 10 seconds, or press the MENU button to return to normal TV viewing.

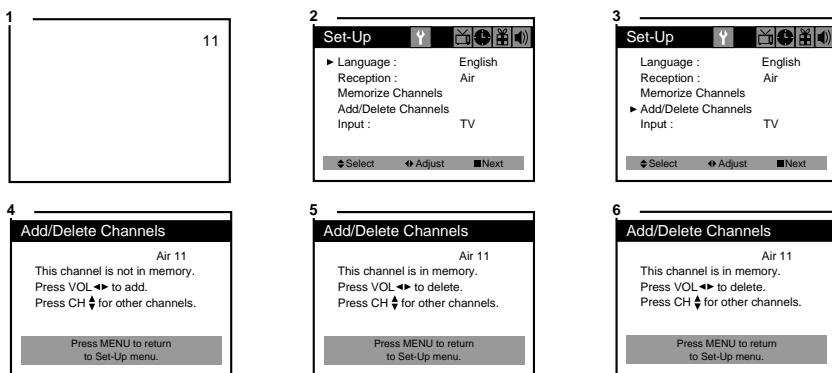

Displaying the Current Channel

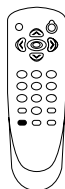

- 1 To quickly see the current channel number and status, press DISPLAY button on the remote control.
The current channel number and status will be displayed.

Changing the TV's Input

Normally, your TV displays the signal coming through the antenna terminal. However, If you've connected another component to your TV (such as a VCR) using the Video/Audio input, you will want to be able to view the signal from the component.

To do this, you will need to switch from the 'TV' input to the 'Line1', 'Line2', 'Line3', 'S-Video' Input, as follows.

- 1 With the TV on, press the MENU button twice, then "Set-Up" menu will appear.
- 2 Use the \blacktriangledown CH \blacktriangle buttons to select "Input".
- 3 Press the \blacktriangleleft VOL \blacktriangleright buttons to change from 'TV' to 'Line1', 'Line2', 'Line3', 'S-Video'.
- 4 Wait 10 seconds, or press the MENU button to return to normal TV viewing.

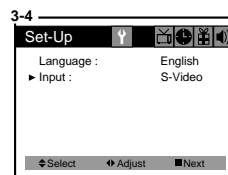
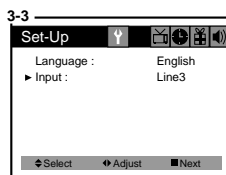
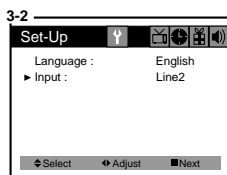
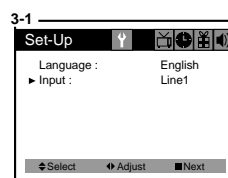
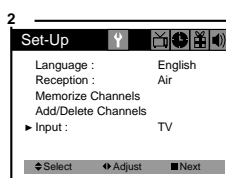
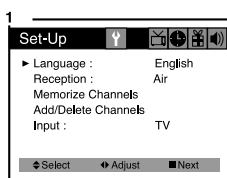

Note

When you watch TV in S-video mode, Audio jack must be connected to AV2 terminal.

Adjusting Video Settings

You may wish to adjust the video settings (e. g. contrast or color) to obtain the most pleasing picture. To do so, follow these directions:

- 1 With the TV on, press the MENU button. then “Video” menu will appear.
- 2 The “Settings” item will be selected. Use the ◀VOL▶ buttons to turn Settings to Preset or Custom.
- 3 Use the ▼CH▲ buttons to select the video setting you wish to adjust. Descriptions of the video settings are on the next page.
- 4 Use the ◀VOL▶ buttons to adjust the video setting to the level you prefer.
- 5 Use the ▼CH▲ buttons to select another video setting to adjust.
- 6 When you are finished, press the MENU button to return to normal TV viewing.
- 7 Video button on the Remote Controller, can do the same function.

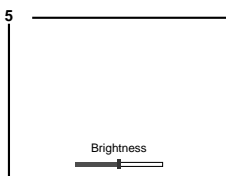
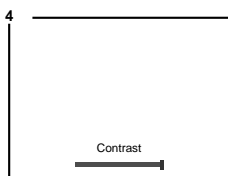
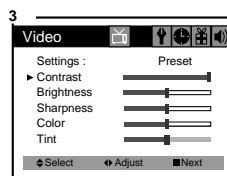
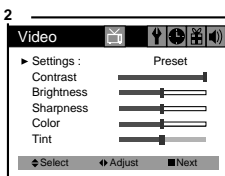
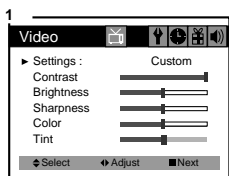

Returning to the factory settings

If you would like to return to the original video settings, as they were calibrated at the factory, follow these steps :

- 1 With the TV on, press the MENU button. then “Video” menu will appear.
- 2 Press the ◀VOL▶ buttons to set the “Settings” to ‘Preset’.

The TV will remember the ‘Custom’ settings you had previously chosen. When you set “Settings” to ‘Custom’ again, your previous custom settings will be restored.

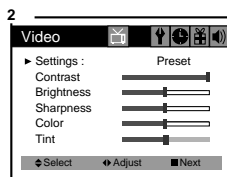
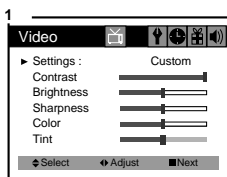

Descriptions of video settings

The contrast setting controls the relation between the light and black areas of the screen. If the light areas are too bright and are losing details, press the ◀VOL button; if the picture is gray and lacks contrast, press the VOL▶ button.

The brightness settings controls the overall amount of light in the picture. If the picture is too bright, press the ◀VOL button; if the picture is too dark, press the VOL▶ button.

Sharpness controls how the TV displays edges of objects on-screen. If the TV shows multiple vertical lines at the edges of an object, press the ◀VOL button; if the vertical edges of on-screen objects are fuzzy, press the VOL▶ button.

The color setting controls the intensity of color. If the color is over-saturated, press the ◀VOL button; if the color is washed out, press the VOL▶ button.

The tint setting controls the relationship of red and green in a picture. Tint is especially noticeable in flesh tones. If flesh tones seem too red or purple, press the VOL▶ button; if flesh tones are too green, press the ◀VOL button.

Using Timer Functions

Your TV has a built in-clock, and you can set the TV to turn on and off at times that you select. You can also set your TV to turn off after counting down a certain amount of time.

Setting the Clock

- 1 With the TV turned on, press the MENU button until “Time” menu will be displayed.
- 2 The “Set Clock” item will be selected. Press the ◀VOL▶ buttons to set the clock. If you hold down either ◀VOL or VOL▶ button, the corresponding numbers will change more quickly.
- 3 When the clock is set correctly, use the ▼CH▲ buttons to select another “Time” function, or press the MENU button to return to normal TV viewing.

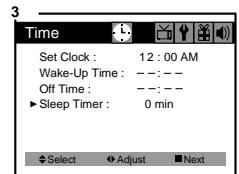
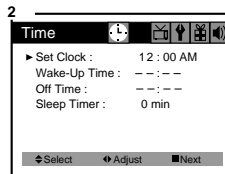
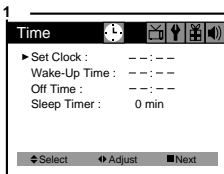

Setting the Wake-up time

If you enter a time in the “Wake-Up Time” setting, your TV will automatically turn on at that time. Follow these instructions to set the “Wake-Up Time”.

After Wake-up Time turned on the TV set, if user do not input the user control (e.g. remote CH or VOL key) within 15 minutes, the TV set will turn off automatically. If user input the user control within 15 minutes, the TV set will turn on continuously.

It is safety feature to prevent from any kind of problem without human control.

- 1 With the TV turned on, press the MENU button until “Time” menu will be displayed.
- 2 Use the ▼CH▲ buttons to select “Wake-Up Time” item.
- 3 If you hold down either ◀VOL or VOL▶ button, the corresponding numbers will change more quickly.
- 4 When the setting is correct, use the ▼CH▲ buttons to select another “Time” function, or press the MENU button to return to normal TV viewing.

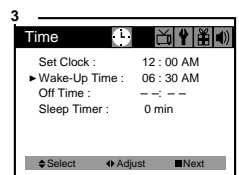
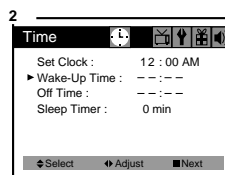
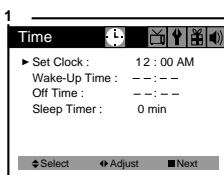

Setting the Off Time

If you enter a time in the “Off Time” setting, your TV will automatically turn off at that time. Follow these instructions to set the “Off Time”.

- 1 With the TV turned on, press the MENU button until “Time” menu will be displayed.
- 2 Use the ▼CH▲ buttons to select “Off time” item.
- 3 If you hold down either ◀VOL or VOL ▶ button, the corresponding numbers will change more quickly.
- 4 When the setting is correct, use the ▼CH▲ buttons to select another “Time” function, or press the MENU button to return to normal TV viewing.

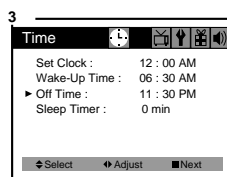
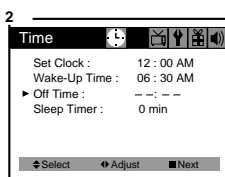
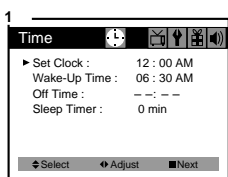

Canceling the Wake-up Time or Off Time

If you would like to cancel the Wake-up Time or the Off Time, Press the ◀VOL▶ buttons until the time settings return to "--:--".

The Wake-up Time and Off Time will not function correctly unless the clock has been set.

Setting the Sleep Timer

The sleep timer allows you to set an amount of time from 15 minutes to 120 minutes. TV will count down the amount of time you set, then turn itself off.

To set the sleep timer:

- 1 With the TV turned on, press the MENU button until “Time” menu will be displayed.
- 2 Use the ▼CH▲ buttons to select “Sleep Timer” item.
- 3 Use the ◀VOL▶ buttons to set the sleep time. Each time you press VOL, you step between the available sleep times : 15min, 30min, 45min, 60min, 90min, or 120min.
- 4 When the setting is correct, use the ▼CH▲ buttons to select another “Time” function, or press the MENU button to return to normal TV viewing.
- 5 You can also set the “Sleep Timer” during normal TV viewing, simply by pressing the SLEEP button on the remote control. This button steps through the available sleep times(see step 3), one by one.

To cancel the Sleep timer, turn the TV off, or set the sleep time to “0” using one of the methods described above.

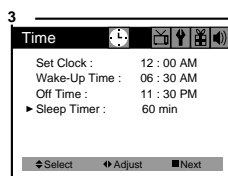
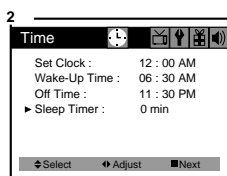
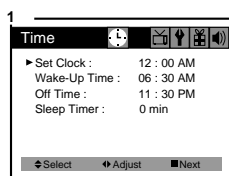

Using the Special Features

This section contains descriptions of the more advanced features of your TV.

Changing the Language of the On-screen Menus

You can choose to display the on-screen menus in English, Spanish, French.

To change the on-screen language:

- 1 With the TV on, press the MENU button twice, then “Set-Up” menu will appear.
- 2 The “Language” item will be selected. Press the ◀VOL▶ buttons to select the language you want to use: English, Español, Français.
- 3 To return normal TV viewing, press the MENU button to return to normal TV viewing.

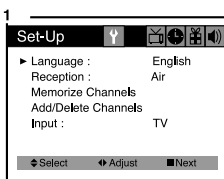

Captioning

Many TV shows contains “Closed Caption”. These captions are hidden words that can be displayed on your TV screen. There are two types of these words : “captions” usually follow the action on-screen, providing a written version of the dialogue, narration, and sound effects ; “text” is not usually related to the action on-screen, often providing information such as news or weather. A TV program might be providing more than one set of captions or one set of text.

To set your TV to display captions or text.

- 1 With the TV turned on, press the MENU button until “Special” menu will be displayed.
- 2 The “Closed Caption” item be selected. To turn captioning on, use the ◀VOL▶ buttons to select Captions (C1 or C2) or Text (T1 or T2).
At the time these instructions were written, only C1 is normally available, but feel free to try the other selections.
- 3 Wait 10 seconds, or press the MENU button to return to normal TV viewing.
Your setting will remain intact until you change it.

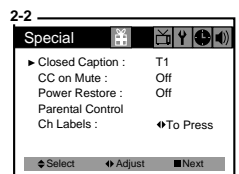
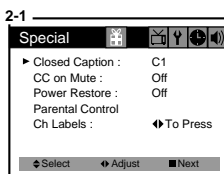
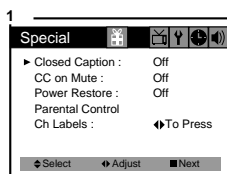

CC on Mute

When the sound is muted, user can select the caption display. It will display the caption content instead of sound mute.

- 1 With the TV turned on, press the MENU button until “Special” menu will be displayed.
- 2 Use the ▼CH▲ buttons to select “CC on Mute” item.
- 3 Use the ◀VOL▶ buttons to select “C1” or “C2”.

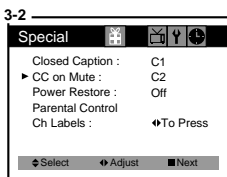
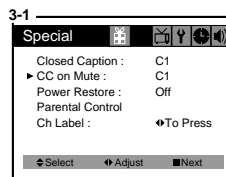
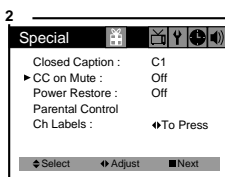
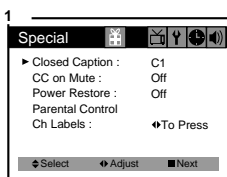

Power Restore

User can select the On/Off status when the power cord put into the wall outlet. If user have a cable box with AC outlet, then user can connect the TV power cord to the AC outlet and control the TV without TV remote control. This function is rarely used for home use, so special care is needed while using.

- 1 With the TV turned on, press the MENU button until “Special” menu will be displayed.
- 2 Use the ▼CH▲ buttons select “Power Restore” item.
- 3 Use the ◀VOL▶ buttons to select “On” or “Off”.

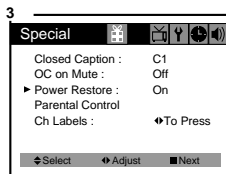
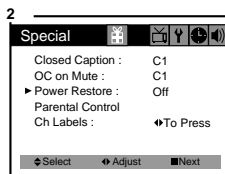
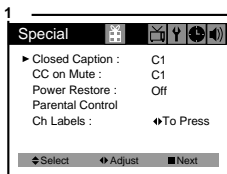

Parental Control Settings

This item helps parents to set the standard for the programs which their children is going to watch.

- 1 With the TV on, press the MENU button until “Special” menu will appear.
- 2 Use the ▼CH▲ buttons to select “Parental Control” item.
- 3 Use the ◀VOL▶ buttons to enter into “Parental Control” settings.
- 4 Use the number buttons(0-9) to enter your password, then “Parental Control” menu will be displayed. If this is the first time you are using your “Parental Control” menu, after entering your password you have to remember it.
- 5 The Parental Lock feature will be selected. Use the ◀VOL▶ buttons to toggle “On” or “Off”.
- 6 Use the ▼CH▲ buttons to select the Parental Control settings you wish to adjust. Descriptions of the Parental Control settings are on the next page.
- 7 Use the ▼CH▲ buttons to adjust the Parental Control settings.
- 8 Use the MENU button to return to the one level up menu.

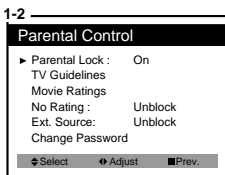
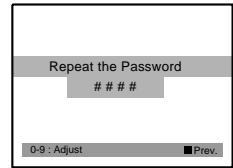
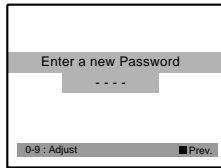
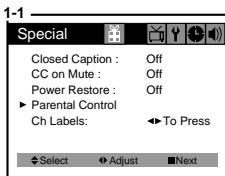

Description of Parental Control Settings

- 1 The TV Guidelines set the standard for TV programs excluding sports and news.
Use the ▼CH▲ buttons to select, ◀VOL▶ buttons to adjust. You can set individual settings with ◀VOL▶ buttons.
- 2 The Movie Ratings set the standard for movie, video, and other media excluding TV programs.
Use the ▼CH▲ buttons to select, ◀VOL▶ buttons to adjust.
- 3 The No Rating item toggles between “Unblock” and “Block”.
This item determines whether to block or not the programs which are not rated by “Movie Ratings ” and “TV Guidelines”.
Use VOL buttons to change the settings.
- 4 The Set Password item let you change the password for entering Parental Control item.
You had better change the initial password “0000”. Use ◀VOL▶ buttons to enter the password in;ut display, and use the number buttons(0-9) to enter new password. After you entered the new password, confirmation display will appear. Type again the password.

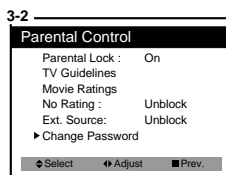
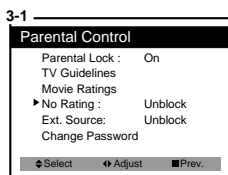
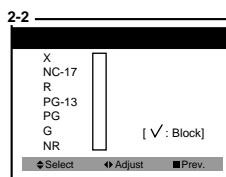
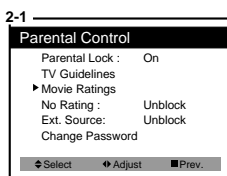
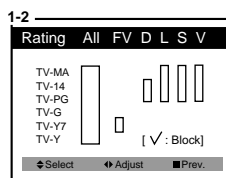
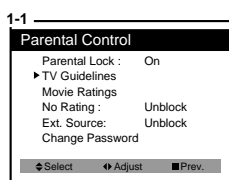

No Ratings means

- 1 When V-chip data is error.
- 2 When any ratings are not deleted.
- 3 Received a rating of “None” like news, sports, and emergency broadcast signals.

Mini Glossary

MOVIE RATING SYSTEM

X	Hard Core Films	Not for children under age 17 under any circumstance. Strong sexual content.
NC-17	Restrictd viewing	Same as X rating.
R	Restrictd viewing	Not for children under age 17. Strong element of sex and/or violence.
PG-13	Parental Guidance Suggested	Program is inappropriate for preteens, with a greater degree of offensive material than a PG rated program.
PG	Parental Guidance Suggested	Content is such that parents may not want their children to view the program.
G	General Audience	Content not offensive to most viewers.
NR	Not Rated	A motion picture that chid not receive a rating for a variety of possible reasons.

TV PARENTAL GUIDELINE RATING SYSTEM

TV-MA	Mature Audience Only	Adults only, may contain Strong Dialog. Bad Language. Sex.
TV-14	Parents Strongly Cautioned	Unsuitable for children under 14. may contain Strong Dialog. Bad Language. Sex. and Violence Scenes.
TV-PG	Parental Guidance Suggested	Unsuitable for younger children, may contain Suggestive Dialog. Bad Language. Sex. and Violence Scenes.
TV-G	General Audience	Considered suitable for all audience; children may watch unattended.
TV-Y7	Children 7 and over	Consider suitable for children over 7. may contain Fantasy Violence Scenes.
TV-Y	Children	Consider suitable for all children under 7 years old.

Ch Labels

This feature allows you to enter a 4 letter channel identifier of your choice that will appear over the channel number display.

The labeling can be anything you want.

- 1 With the TV turned on, press the MENU button until “Special” menu will be displayed.
- 2 Use the ▼CH▲ buttons to select “Ch Labels” item.
- 3 Press VOL▶ on the remote control(or on the TV) to select the 1st character space.
- 4 Press ▼CH▲ repeatedly until the 1st character(“A” in this example) appear in the 1st character space.
- 5 Press VOL▶ once to enter the 1st character and to advance to the next character space.
- 6 Repeat steps 4–5 to enter the 2nd 3rd and 4th characters(“B”, “C”, “D” in this example), and when you press VOL▶ for the last time, the channel label has been stored in the memory.

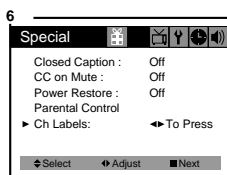
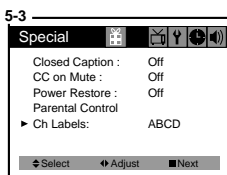
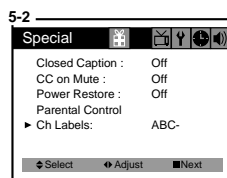
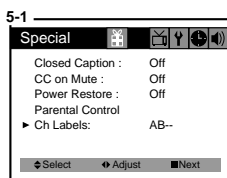
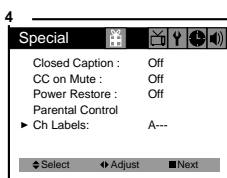
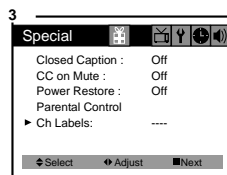
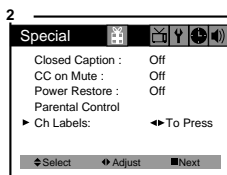
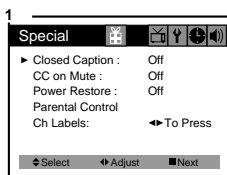

NOTE

Each time you press the ▼CH▲ buttons, the displayed character will change in the following order.

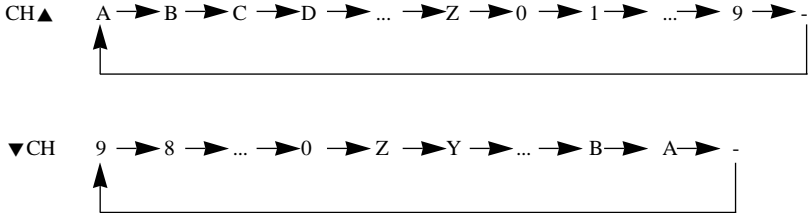

Cearing Channel Labels

1. Select the channel which has the label you want to clear.
2. 3.4. Follow step 1~3 on the “Ch Labels” to call up the Ch Labels mode display.
5. Enter “-” in first character spaces.

Adjusting the Sound

Selecting stereo/SAP

The MTS(Multi-channel TV Sound) provides for an extra sound channel. So MTS feature allows you to improve your TV viewing with high fidelity stereo sound. SAP(Second Audio Program) used to transmit a second language of other audio information. If your TV receives a stereo sound(or SAP) broadcast, when the TV is turned on, select other channel or press the RECALL button on the remote control the word “Stereo”(or “SAP”) is displayed on the screen.

Listening to stereo sound

- 1 With the TV turned on, press the MENU button until “Audio” menu will be displayed.
- 2 Use the ▼CH▲ buttons select “Audio Mode” item.
- 3 Press the ◀VOL▶ buttons repeatedly until: “Stereo” is displayed.
- 4 Press the button twice or wait few seconds to return to normal TV viewing.
- 5 Your setting will remain intact until you change it. Your TV will then automatically reproduce either stereo or monaural sound, whichever is broadcast.

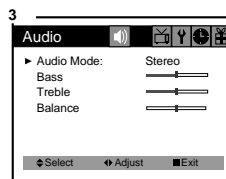
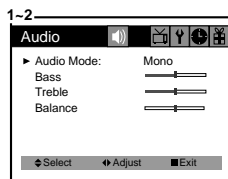

Listening to second Language

- 1 Follow steps 1~2 in “Listening to stereo sound” above.
- 2 Press the ◀VOL▶ buttons repeatedly until: “SAP” is displayed.
- 3 Press the MENU button twice or wait few seconds to return to normal TV viewing.
- 4 If a SAP broadcast is received, you will hear only the second language from the speaker.

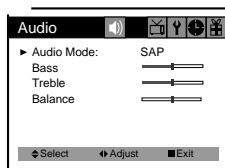

Using Direct button on the remote control

- 1 You can also change the Audio Mode setting with the remote control. Press the MTS button on the remote control to select Audio Mode.
- 2 Use this button to select the Stereo, Mono or SAP.

Present Broadcast	Your Selection	Speaker Out
MONO	Stereo	Mono
MONO	SAP	Mono
STEREO	SAP	Mono
STEREO and SAP	Stereo	Stereo
STEREO and SAP	SAP	SAP

Note

If a broadcast signal is weak, it may cause noise and hum in stereo sound. Please select the Mono mode, the noise and hum should be reduced.

Adjusting the Bass

- 1 With the TV turned on, press the MENU button until “Audio” menu will be displayed.
- 2 Use the ▼CH▲ buttons select “Bass” item.
- 3 Press the ◀VOL button to decrease the bass volume.
- 4 Press the VOL▶ button to increase the bass volume.
- 5 Press the MENU button twice or wait few seconds to return to normal TV viewing.
- 6 Your setting will remain intact until you change it. Your TV will then automatically reproduce either stereo or monaural sound, whichever is broadcast.

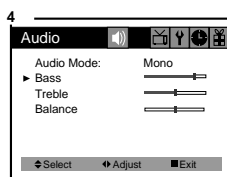
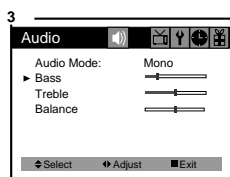
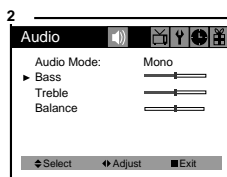
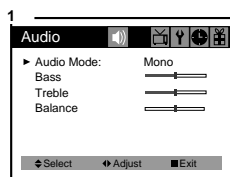

Adjusting the Treble

- 1 With the TV turned on, press the MENU button until “Audio” menu will be displayed.
- 2 Use the ▼CH▲ buttons select “Treble” item.
- 3 Press the ◀VOL button to decrease the treble volume.
- 4 Press the VOL▶ button to increase the treble volume.
- 5 Press the MENU button twice or wait few seconds to return to normal TV viewing.
- 6 Your setting will remain intact until you change it. Your TV will then automatically reproduce either stereo or monaural sound, whichever is broadcast.

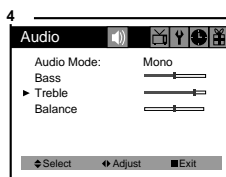
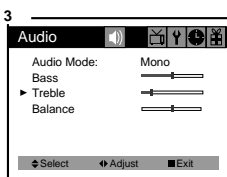
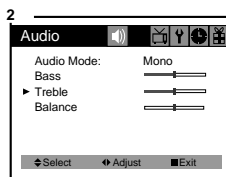
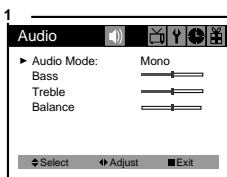

Adjusting the Balance

- 1 With the TV turned on, press the MENU button until “Audio” menu will be displayed.
- 2 Use the ▼CH▲ buttons select “Balance” item.
- 3 Press the ◀VOL button to decrease the left speaker volume.
- 4 Press the VOL▶ button to decrease the right speaker volume.
- 5 Press the MENU button twice or wait few seconds to return to normal TV viewing.
- 6 Your setting will remain intact until you change it. Your TV will then automatically reproduce either stereo or monaural sound, whichever is broadcast.

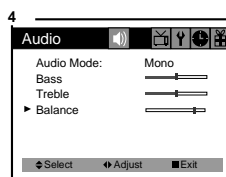
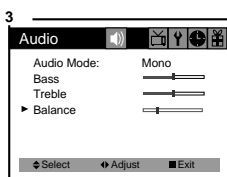
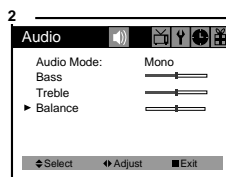
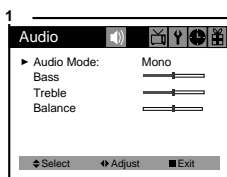

Troubleshooting

Your Daewoo television is designed to give you trouble-free performance for many years. If you have a problem with your TV, try the solutions listed below.

If the suggestions listed below do not solve your problem, contact your Daewoo dealer or an authorized Daewoo service center.

There is no picture or sound, or the TV doesn't turn on.

- Make sure the TV is plugged in.
- Make sure the MUTE is not set.
- Make sure the power is on.
- If there is neither picture or sound, unplug the TV for 30 seconds, then plug it in and try again.

There is no picture or sound on some UHF channels.

- Try another station. If the other stations are OK, it may be a station problem.
- Check that the antenna is connected, is in good working order, has no broken wires, and is adjusted correctly.
- See if anything is interfering with the antenna signal.
- Make sure the AIR/CABLE setting is correct.

The sound is OK, but the picture is poor.

- Try another station. If the other stations are OK, it may be a station problem.
- Check that the antenna is connected and is in good working order, has no broken wires, and is adjusted correctly.

The picture is OK, but the sound is poor.

- Try another station. If the other stations are OK, it may be a station problem.
- Check that the antenna is connected, is in good working order, has no broken wires, and adjusted correctly.

There is poor reception on some channels.

- Try another station. If the other stations are OK, it may be a station problem.
- Check that the antenna is connected, is in good working order, has no broken wires, and is adjusted correctly.

You cannot tune to a cable channel.

- Make sure the AIR/CABLE setting is correct.
- The channel may not be programmed into memory.

The picture rolls, slants, shows lines, is grainy, has poor color, or has ghosts.

- Try another station. If the other station are OK, it may be a station problem.
- Check that the antenna is connected, is in good working order, has no broken wires, and is adjusted correctly.
- See if anything is interfering with the antenna signal.

The remote control does not work.

- Make sure the TV is plugged in.
- Make sure there are fresh batteries in the remote control.
- Make sure there is nothing blocking the remote control signal.

Warranty

Daewoo Electronics Corporation of America warrants each new electronic product manufactured by it to be free from defective material and workmanship and agrees to remedy any such defect or to furnish a new part (at the Company's option) in exchange for any part of any unit of its manufacture which under normal installation, use, and service disclosed such defect, provided the unit is delivered by the owner to us or to our authorized distributor from whom purchased or authorized service station, intact, for our examination with all transportation charges prepaid to our factory. To establish and receive warranty service at our factory or authorized service facilities, proof of purchase/dated sales invoice is required

Return authorization must be obtained before any merchandise is returned to the factory.

This warranty does not extend to any of our electronic products which have been subjected to misuse, neglect, accident, incorrect wiring not our own, improper installation, unauthorized modification, or to use in violation of instructions furnished by us, nor units which have been repaired or altered outside of our factory, nor to cases where the serial number thereof has been removed, defaced, or changed.

This warranty is in lieu of all warranties expressed or implied and no representative or person is authorized to assume for us any other liability in connection with the sale of our electronic products.

Over-the-counter exchange for units that are initially defective

"Initially defective" is described as when the dealer opens the unit and finds that it is inoperative or a customer opens a new unit and finds that it is inoperable. This unit may be returned to the factory by the dealer for exchange. Under no circumstances will the customer be permitted to return the defective unit directly to the factory.

Exchange must be directly with the dealer.

Model	Parts	Labor	Picture Tube
DTQ-25S5FC	1 year	90 days	2 years
DTQ-27S5FC	1 year	90 days	2 years



This instrument is listed by Underwriter's Laboratories, Inc. It is designed and manufactured to meet rigid U.L. safety standards against X-radiation, fire, casualty and electrical hazards.

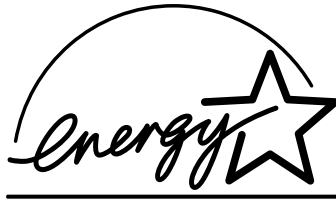

As an ENERGY STAR[®] Partner DAEWOO Electronics has determined that this product or product model meets the ENERGY STAR[®] guidelines for energy efficiency.



DAEWOO

Daewoo Electronics Corporation America

120 Chubb Avenue
Lyndhurst, NJ 07071

For more information about this or other Daewoo products, please call 1-800-DAEWOO8.

P/N : 48586011E107-R0

Free Manuals Download Website

<http://myh66.com>

<http://usermanuals.us>

<http://www.somanuals.com>

<http://www.4manuals.cc>

<http://www.manual-lib.com>

<http://www.404manual.com>

<http://www.luxmanual.com>

<http://aubethermostatmanual.com>

Golf course search by state

<http://golfingnear.com>

Email search by domain

<http://emailbydomain.com>

Auto manuals search

<http://auto.somanuals.com>

TV manuals search

<http://tv.somanuals.com>