

DAEWOO



Instruction manual



GB14F8T1
GB20F8T2
GB21F1T2

VIDEO *Plus+*

W O R T H k n o w i n g

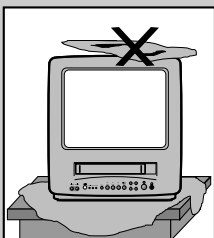
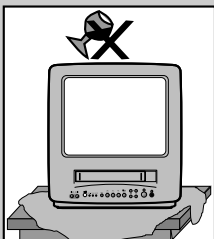
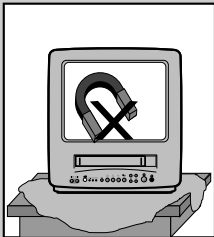
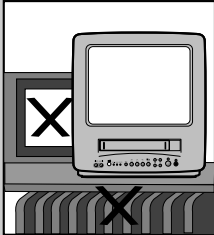

Please keep the video machine's guarantee card and receipt safe for warranty purposes.

Precautions

- ◆ Read carefully through this manual to familiarise yourself with this high-quality televideo.
- ◆ Make sure the rating of your household electricity supply matches that shown on the back of the televideo.
- ◆ Refer to this chapter and the "Initial installation" chapter (pages 4-9) to help you install and adjust your televideo.

Do not...

- ◆ expose the televideo to high levels of humidity and heat, to avoid the risk of fire and electric shock.
- ◆ open the televideo. Have a qualified technician carry out repairs.
- ◆ connect the televideo to the power supply if you have just moved it from a cold to warm environment. This can result in condensation inside the recorder and cause serious damage to the machine and cassettes. Wait around two hours to allow it to reach room temperature.

Make sure...

- ◆ the televideo is placed on a steady, flat surface.
- ◆ you place the televideo where there is good ventilation all around.
- ◆ you clean the televideo only with a soft, lint-free cloth; do not use aggressive or alcohol-based cleaning agents. (Unplug the set from the mains)
- ◆ you disconnect the power supply if the televideo appears to be working incorrectly, is making an unusual sound, has a strange smell, has smoke emitting from it or liquids have got inside it. Have a qualified technician check the televideo.
- ◆ you disconnect the power supply and aerial if you will not be using the televideo for a long period or during a thunderstorm.

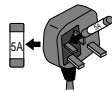

The power cable must be fitted with a fused plug approved by ASTA or BSI to BS 1362 and provided with a 5A fuse.

The fuse cover must always be securely replaced. If the televideo is not working, the fuse may need replacing (see also "Electrical Connection" on page 4). **(U.K. Only)**

For your own safety!

- ◆ There are no components in this televideo you can service or repair yourself.
- ◆ Do not open the case of the televideo. Only allow qualified personnel to repair or service your set.
- ◆ This televideo is designed for continuous operation. Switching it off does not disconnect it from the mains (stand-by). To disconnect it from the mains, you have to unplug it.
- ◆ Recording any copyright protected material may infringe a copyright.





Before doing anything with the televideo, please read the chapter "Initial installation".

Contents

Controls

The remote control unit	2
The televideo, On-screen display	3

Initial installation

Moulded plugs	4
Connecting up the televideo, Fitting the remote control's batteries	6
Setting time and date	7
Tuning in stations, EDIT, Manual Tuning	8-10

Playing cassettes

Playing back	12
Still, Variable picture search, Continuous play	13

Recording cassettes

Simple recording, One touch recording (OTR)	14
Timer recording using VideoPlus+	15
When record time overlaps, Watching Programmes while recording	16
Normal timer recording	17
Timer Review-erasing or changing	18-19

More functions

Accessing the beginning of the next recording, Accessing the beginning of the previous recording, Resetting the counter to zero, Accessing counter zero position	20
Cassettes, V-Lock, Child Lock, Mute	21
Picture adjustments, picture type selection, Changing on-screen displays	22
Television timer, Snooze automatic	23
VideoPlus+ guide numbers	24
Teletext, teletext character set	25

Connections and copying

copying, Assembling	26
Scart socket	27

Appendix

Before you ask a specialist	28
Playing back, Simple recording, Auto tracking, One touch recording	29
Index, Technical data	30
Your product guarantee	31/32



- ◆ On the following pages, the pictures show the buttons you press on the remote control to perform the function, and what you should see in the on-screen display or machine display (if present)
- ◆ VideoPlus+ is a trademark applied for by Gemstar Development Corp.. The VideoPlus+ system is manufactured under license from Gemstar Development Corporation.

CONTROLS

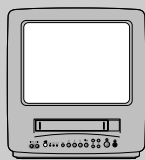

- ◆ The remote control is the principle means of control, but the main playback and record functions are also available on the front of the machine.
- ◆ Press the main power switch on the front panel **to turn on the set**, then press button.

The remote control unit

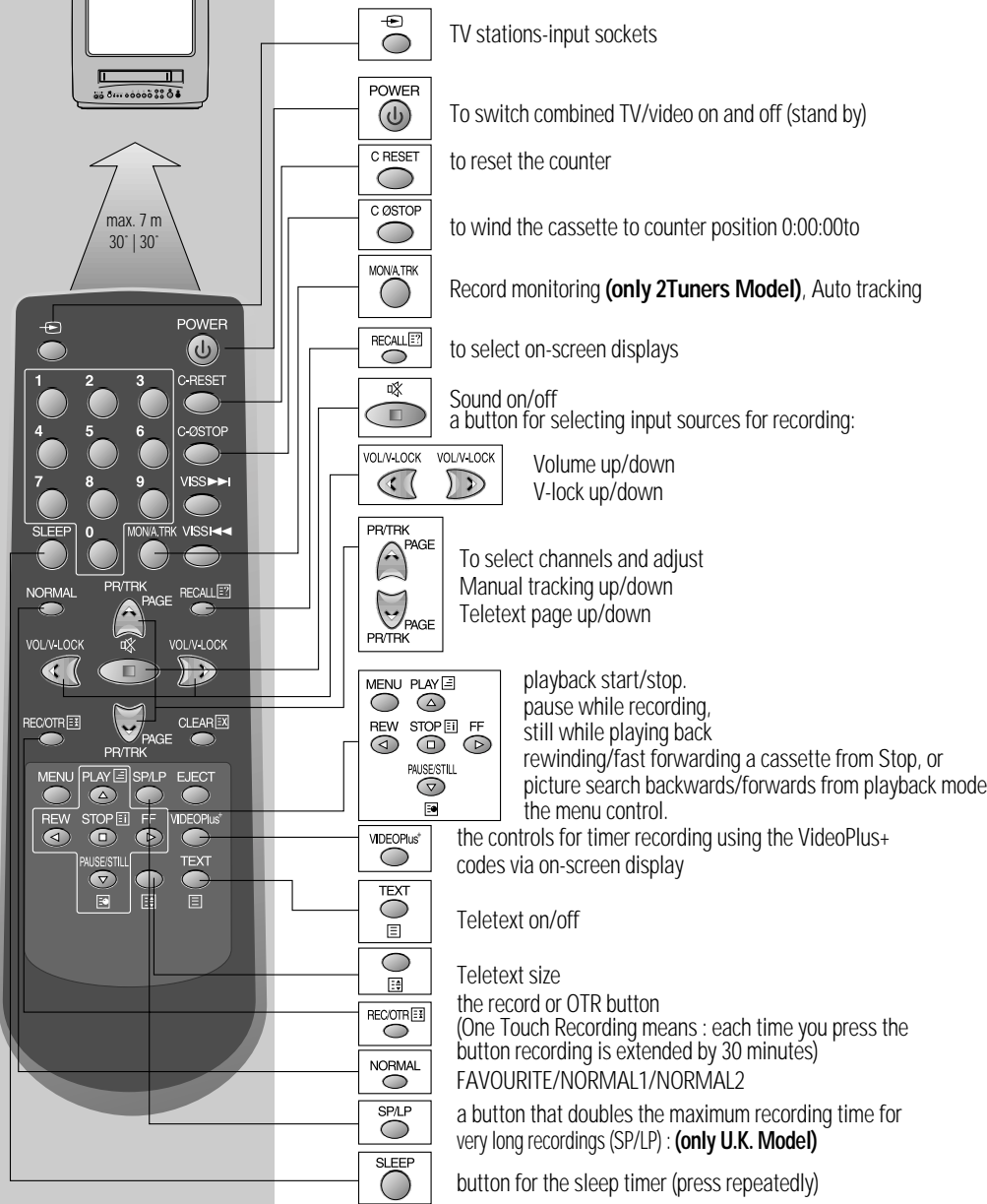

CONTROLS

- ◆ Press the main power switch on the front panel to turn on the set, then press POWER (⏻) button.

The televideo

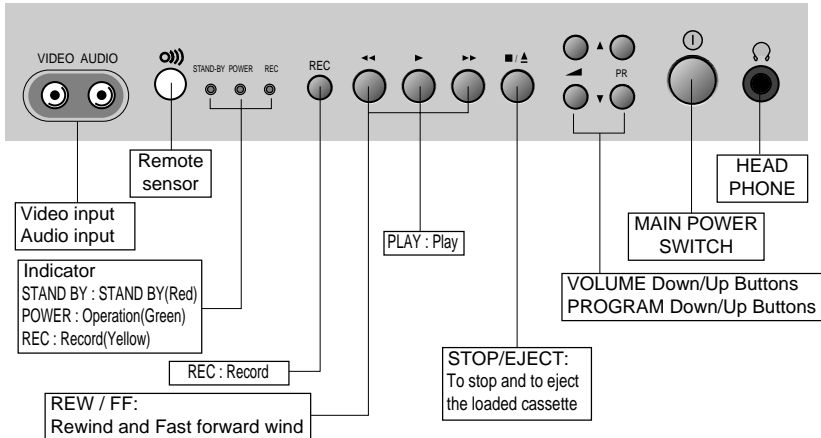

On-screen display



MENU



The televideo's menu system gives you easy-to-understand access to the less used functions such as tuning to stations, clock setting and more.

PLAY



REW



STOP



FF



PAUSE/STILL



The menus show you which button to press for the next step.

REW



In addition, some other functions appear on screen if you want (press RECALL up to 3 times for on-screen displays).

Initial INSTALLATION

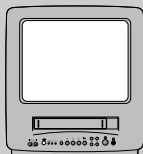

- ◆ *For your own safety read the following instructions carefully before attempting to connect this unit to mains.*

Moulded plugs

- ◆ Should it be necessary to remove a moulded on plug from the mains cable, it should be cut off and replaced with a suitable replacement.

If the terminals in the plug are unmarked or you are in any doubt as to the correct connections, consult a qualified electrician.

- ◆ The wires in this mains lead are coloured in accordance with the following code

Blue	Neutral
Brown	Live

As the colour of the wires in the mains lead of this appliance may not correspond with the coloured markings identifying the terminals in your replacement plug proceed as follows.

The wire which is coloured blue must be connected to the terminal which is marked with letter N or coloured black.

The wire which is coloured brown must be connected to the terminal which is marked with letter L or coloured red.

- ◆ The moulded plug cannot be used for any other appliance, therefore remove the fuse and dispose immediately and safely to prevent anyone, especially children from plugging it in to a wall socket, which will create a safety hazard.
- ◆ After replacement of the fuse in the moulded plug, the fuse cover must be refitted. If the fuse cover is lost a replacement cover must be obtained. The colour of the correct replacement fuse cover is that of the coloured insert in the base of the plug or the colour that is embossed in words in the base of the plug recess or elsewhere on the plug. Always state this colour when ordering a replacement fuse cover.
- ◆ Only 5 amp. replacement fuses which are ASTA approved to BS 1362 should be fitted. **(U.K. Only)**



- ◆ We recommend the use of a good quality plug.

I n i t i a l INSTALLATION



This symbol means that this unit is double insulated, an earth connection is not necessary.



Caution :
To prevent electric shock, do not remove any covers.



Caution :
No user serviceable parts inside, refer servicing to qualified service personnel.



Caution :
When operating this unit on 220-240V mains supply, please note that when the power switch is in the off mode, the unit is not disconnected from the mains supply. However, please be assured that it is perfectly safe to leave the unit connected to the mains supply.

Initial INSTALLATION

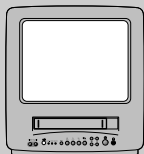

The buttons to use are marked on the following pages.

Place your televideo

- ◆ horizontally on a flat, steady base so that air can circulate around it for ventilation.
- ◆ away from humidity and heat, magnetic fields, such as those from loudspeakers etc., and with no heavy objects placed on top.

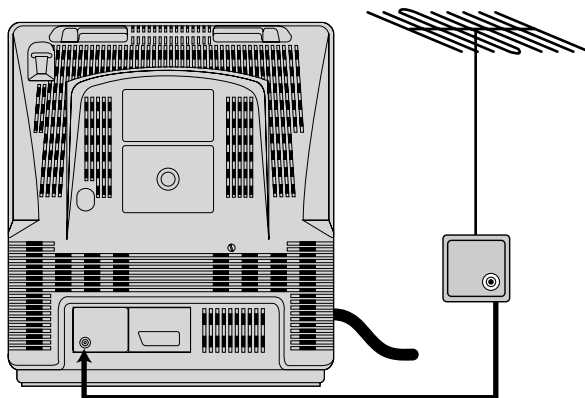

Connecting up the televideo

Switch off all components when connecting or disconnecting cables.

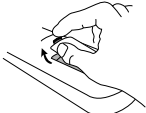
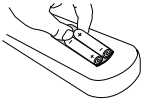

- ◆ Plug the aerial cable into the "ANT" socket of the televideo.
- ◆ Make sure the rating of the household mains supply matches the rating shown on the back of the televideo.
Now plug in the mains lead.

Fitting the remote control's batteries

<p>1 Remove the battery cover on the reverse side of the remote control.</p> 	<p>2 Install two batteries ("AAA" size) into the remote control.</p> 	<p>3 Replace the battery cover.</p> 
---	---	---

- ◆ **Fit the batteries, size 1.5V AAA** as shown above.
- ◆ Protect your environment by returning used batteries to your dealer. Since batteries contain toxic substances they require special disposal methods.
- ◆ Make sure the batteries are always of the same type and age, and remove them from the remote control if you are not using it for a long period.

I n i t i a l INSTALLATION

- ◆ *Timer controlled events require the exact time and the correct date.*
- ◆ *Press the main power switch on the front panel to **turn on the set**, then press  button.*

Setting time and date

POWER





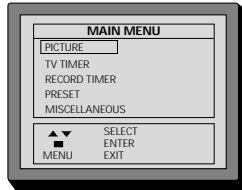

Switch your televideo on.

MENU

Call the televideo's MAIN MENU.

 or
and

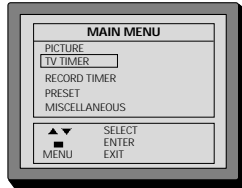



Move the cursor down to the "TV TIMER" line.

Confirm by pressing the ENTER/STOP button.







Set the numbers for the exact time and the correct date. Both the On timer and the off timer can be switched ON or OFF but both must be on to enable the timer to function.

DATE : dd/mm/yy
TIME : Hour/Min

MENU

Store leaving "TV TIMER"
Continue with the following page.

◆ Mistake or change ?

Move cursor to the position you wish to correct by using / / and RE-ENTER on the remote control.



- ◆ If you do not set 'DATE' and 'TIME' menu, you can not set 'on/off Timer'.

Initial INSTALLATION

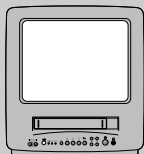

◆ Have handy a TV guide or newspaper to help you to identify the stations.

Tuning in stations

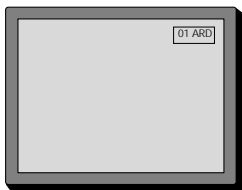

(If you see "AV" instead of "PR", press the button)

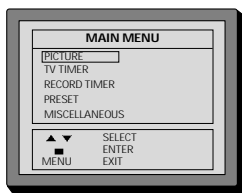

MENU

If not on-screen, call the televideo's "MAIN MENU".

AUTOMATIC TUNING SYSTEM

Select the PRESET menu at the MAIN MENU.

Place the cursor to "ATSS" with the up/down button.

Press the ENTER button until the tuning screen appears above the PRESET menu.

The cursor will move from left to right on the VHF-L line, then VHF-H, then UHF. Please wait until the EDIT menu appears.

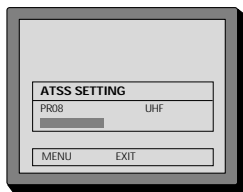

I n i t i a l INSTALLATION

EDIT

(MAIN MENU → PRESET → EDIT)

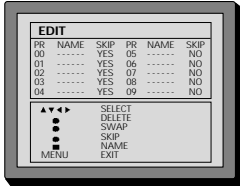

The EDIT menus shows you the programme position assignment. You can change this programme position assignment according to your personal preferences.

SKIPPING THE CHANNELS

You can select skip "YES" or "NO" with the SKIP button.

A programme marked with SKIP "YES" is skipped when changing channel using the ▲/▼ button.

A skipped programme number selected by NUMBER button 0...9 will be displayed in red.

DELETE PROGRAMME POSITION DATA

Position the cursor to programme number to delete with the up/down. LEFT/RIGHT buttons.

Press the DELETE button. while this is being carried out the "DELETE pro.NO". appears and the "deleted" programme number will transfer to programme no.69 and change skip to "yes".

Any programme that was in No.69 will be transferred to programme No.68.

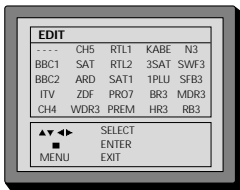

CHANGING THE ORDER OF THE CHANNELS

Position the cursor to programme number to move and press the SWAP button. The "SWAP P01 TO P01" will appear.

Position the cursor to programme number to exchange and press the SWAP button. Two programmes will be exchanged.

ENTER A STATION NAME

Press the stop button at the EDIT MODE.

station name tables appears above the screen.

Select station name in the station name list with ▲/▼ button and press ENTER button.

If you want to delete a station name, select "----".

If you can't find the desired name in the list, you can enter your own.

To do so, move the cursor to the "----" and press ENTER button.

Using the ▲/▼ button, select the desired, letter, number or blank.

Press the ► button to select the next position.



Initial INSTALLATION

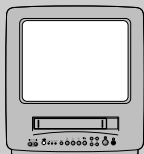

Manual Tuning

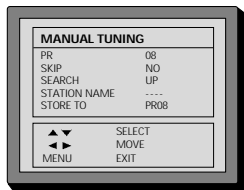

You can also call up the PRESET menu at the MAIN MENU.

Press the NUMBER Button 0...9 or PR ▲/▼ button to select a programme number you want. The screen will change according to the selected programme number.

SEARCHING FOR A CHANNEL

Locate the cursor to SEARCH UP or DOWN with ▲/▼ button at the MANUAL TUNING SCREEN and then press the enter.

The tuning screen will appear and the cursor will move from left to right.

To stop searching, press the MENU button.

Pressing and holding down the ◀/▶ button during 3seconds, the band will change as following.

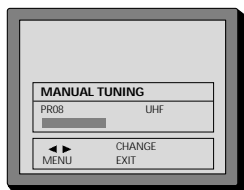

After locating a station, press the menu button.

Select station name and memorize programme number with UP/DOWN button or the NUMBER button 0...9.

use ▲/▼ button to set the SKIP to 'NO'

Press the "enter" key when the cursor is put on the "STORE TO", it is possible to memorise the searched channel.

If you want to select "SKIP YES" PR. use the digit key.

FINE TUNING

If you are unable to get a good picture or sound because of a poor broadcasting signal, it is possible to adjust the fine tuning.

Select the FINE TUNING at the PRESET MENU and FINE TUNING SCREEN will appear.

Press ◀/▶ button to get a good picture and sound you want and to memorize press the ENTER.





PLAYING cassettes

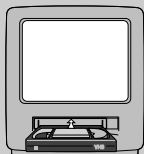

- ◆ Your televideo is switched on by the main power switch on the front panel and by the  button.

Playing back

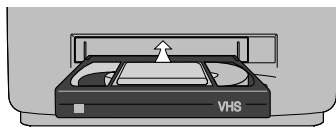

Load the cassette by pushing it smoothly and squarely into the cassette bay, with its windows pointing up.

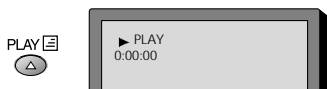

Start playback.

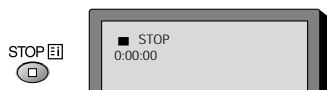

Stop playback.

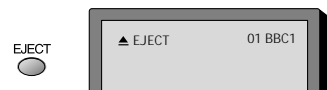

Eject the cassette.



Fast forward or rewind the cassette from stop.

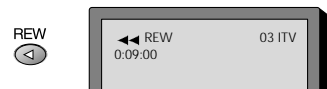

- ◆ A smaller picture may be seen while switching from the SEARCH mode to the PLAYBACK mode. This is NOT a sign of malfunction.
- ◆ When you load a **protected cassette** (e.g. pre-recorded film, see page 21) playback starts automatically.
- ◆ PLAY (▶) switches back to **normal playback**.
- ◆ During still, or search, you don't hear the **sound**.
- ◆ If the still picture is **jittering**, you can steady it by using the VOL/V-LOCK buttons.
- ◆ You can reduce horizontal **interference stripes** resulting from inaccurate tracking (when playing tapes of poor quality or recorded on other machines) by using the PR/TRK buttons during playback or try auto tracking using A.TRK
- ◆ After approx. 5 minutes in still, the cassette plays back automatically.
- ◆ Search and picture functions -page 20.



PLAYING cassettes

Still

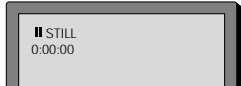

Still picture from playback.
Each press of the button advances the picture one frame.

PLAY (▶) switches back to normal playback.

Variable picture search

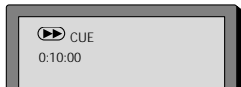

Starting from playback you can control search speed in 2 steps either forwards (▶▶) or backwards (◀◀). Press repeatedly.

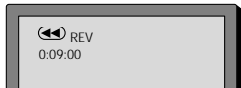

PLAY (▶) switches back to normal playback.

Continuous play

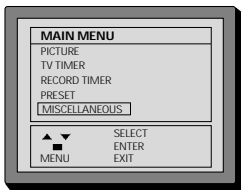

Call the televideo's "MAIN MENU".

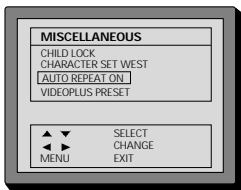
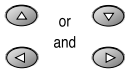

Move the cursor down to the "AUTO REPEAT ON" line.

Confirm.

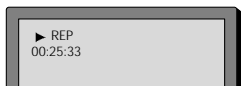

Cassettes with...
... open safety hole:
play → end of cassette → rewind → play...

... closed safety hole :
play → end of cassette → rewind → play...

RECORDING cassettes

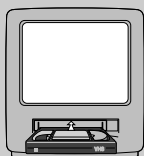

- ◆ The TV stations on your televideo have been tuned in (pages 8/9).
- ◆ The televideo is switched on.

Simple recording

PR/TRK **PAGE**

STOP 0:00:00 **01AB**

Load a cassette with its safety tab in place (see page 21). Choose the station whose programme you want to record.

SP/LP

STOP 0:00:00 **12CD**
12CD

LP

If the programme you wish to record is very long, double the possible recording time with "LP" (Long Play). Up to eight hours with an E240 cassette.

REC/OTR

REC 0:00:12 **12CD**
12CD

Start your recording.

PAUSE/STILL

PAUSE 0:10:34 **12CD**

If you wish to interrupt recording briefly – then continue.

STOP

STOP 1:15:22 **12CD**

Stop your recording.

One touch recording-OTR

REC/OTR

OTR 0:01:10
0:30 **12CD**

Choose the station you want and press the button once for every 30 minutes of programme you wish to record.

• OTR PREPARATION

Before setting OTR, MAKE SURE THAT

The cassette tape has the safety tab.
The tape is long enough to record the program.

- ◆ During recording you can switch the **screen off** pressing button.
- ◆ If you want to record from a **source connected** to your video see page 26.
- ◆ Even if you turn off the POWER, REC/OTR will continue for the rest of the time.
- ◆ You can release the OTR mode by pressing "STOP" during REC mode.
- ◆ The video stops automatically, if pause exceeds five minutes.
- ◆ If the display shows "**AV**" instead of "**PR**" press button.
- ◆ Search and picture functions -pages 20.



RECORDING

c a s s e t t e s

- ◆ For timer recordings, clock, date, and stations must be set correctly (pages 7-9).
- ◆ Load a cassette with its safety tab in place (see page 21) and with sufficient free space for the recording.

Timer recording using VideoPlus+

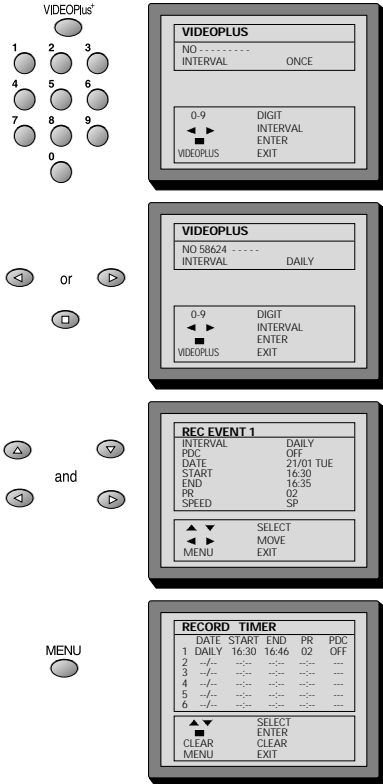

Call the VideoPlus+ menu.

From your TV magazine, type in the number next to the programme you want to record.

Select to record ONCE, DAILY(1x), WEEKLY(2x)

Confirm

If you want to extend the recording time by 1 minutes steps.

Press the menu button to confirm.

You can switch your televideo off.

(Do not use the main power button on the front panel of the set.) The televideo will switch on and off automatically to record the timer event.

- ◆ If you do not set the clock, when you press the VideoPlus+ button to set the timer recording, this set automatically changes to the "TV TIMER" menu.
- ◆ If you don't have the **VideoPlus+ numbers** see page 17 for the normal timer.
- ◆ If you have made a **mistake**, move back to the relevant position with the ◀ button and change the setting.
- ◆ During recording you can switch the **screen off** pressing ⏻ button.
- ◆ The screen will indicate if the station is not programmed (pages 7-9) or if the station has no VideoPlus+ guide number (pages 24).
- ◆ Should programmings **overlap**, you get a warning.
- ◆ In the case of error messages correct the input or check the date and time on your televideo (also check your TV guide).



RECORDING cassettes



When record time overlaps

When setting the Programmable Timer, be careful not to overlap the preset times.

If you happen to overlap the preset Programs, the END Time has priority and the overlapped Programmes cannot be recorded.

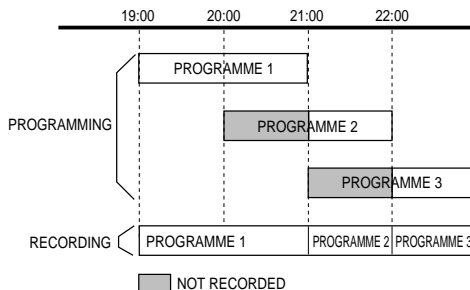

NOTE : MAKE SURE THAT ...

The clock is adjusted to current time
The safety tab is not missing on the cassette tape.
The tape is long enough to record the desired programme.

* If you program events without setting the time, it will be automatically returned to "TV TIMER" mode.
If you program events that overlap, at least one of your events will not record correctly.

If the start time you want to enter does not correspond to the PDC-time or if you just want to record a part of a programme, you have to switch off PDC. Otherwise the recorder won't record.

Watching programmes while recording (Only 2 Tuners Model)

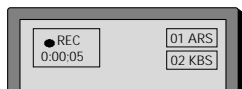

Just switch over to another programme using PR/PAGE ▲/▼ or the NUMBER BUTTONS.

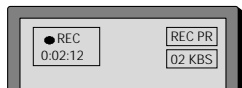

To check the recording switch to the recorder (and back) using the MONITOR/A.TRK button.

- ◆ For timer recordings, clock, date, and stations must be set correctly (page 7-9).
- ◆ Load a cassette with its safety tab in place (see page 21) and with sufficient free space for the recording.
- ◆ To enter station numbers using the number buttons, type **double digit numbers** quickly.

RECORDING

c a s s e t t e s

Normal timer recording

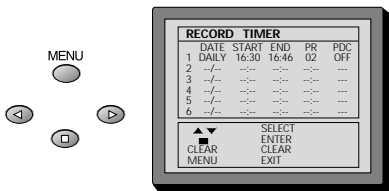

Call the televideo's "MENU", choose "RECORD TIMER"

select a free timer memory.
If necessary erase a memory with clear button.
Confirm.

CLEAR

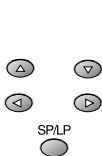

Set:

- ◆ "ONCE" / "DAILY" / "WEEKLY"

- ◆ the date (if not today's),
- ◆ start and stop time,
- ◆ station number (or AV, e.g. for satellite stations) and
- ◆ the recording speed

MENU

Close the menu.

POWER

You can switch your televideo off.

(Do not use the main power button on the front panel of the set.)

The televideo will switch on and off automatically to record the timer event.



- ◆ If you have made a **mistake**, move to the position you want to change using the ◀/▶, ▲/▼ buttons and change the setting.
- ◆ The recorder will **ject** cassettes which have the safety tab removed (page 21).
- ◆ During recording you can switch the screen off pressing ⏻ button.
- ◆ Press ⏻ to use your televideo in the meantime.

RECORDING cassettes

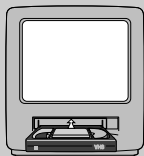

Timer Review - erasing or changing

MENU



CLEAR



Call the televido's "MENU", choose "RECORD TIMER".

Select the programming to erase or change.

If you want to erase this programming press button CLEAR.



CLEAR

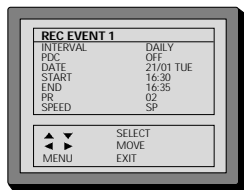

If you wish to make changes : Confirm.

Move to the position you want to change using the $\blacktriangledown/\blacktriangledup, \blacktriangleleft/\blacktriangleright$ buttons.

Change the settings using the $\blacktriangle/\blacktriangledown$ or number buttons.

MENU



If all setting are ok, exit the menu.

RECORDING

c a s s e t t e s



- ◆ PDC will not operate if you are not watching the programme you have set on the timer record function, although you set timer recording using PDC function your TV/VCR does not operate 'PDC timer recording' but operates 'normal timer recording'.
- ◆ If you wish to record from a **satellite** receiver select under "PR" the satellite programme location or AV (depending on the connection with the antenna cable, the SCART-cable). Leave the satellite tuner switched on and to the programme you want.

MORE functions

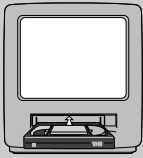

- ◆ Your televideo automatically sets electronic marker (index) at the beginning of each recording and timer recording. It is these markers which the index function detects.

Accessing the beginning of the next recording



Press the button depending on the number of recordings (index marks) that you wish to wind forward. E.g. 3x for 3 recordings ahead.

Accessing the beginning of the previous recording



Press the button depending on the number of recordings (index marks) that you wish to wind backwards. E.g. 3x for 3 recordings back.

Resetting the counter to zero



Reset the counter.

Accessing counter zero position

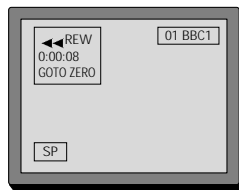

The video will wind to the position 0:00:00 and stop.

When you have finished recording or playing, you can easily return to the point marked in this way.

M O R E f u n c t i o n s

Cassettes

VHS

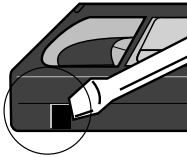

Use only good quality tape cassettes with the VHS logo.

- ◆ Keep cassettes away from excessive moisture or dust, magnetic and electrical fields (loudspeakers and computer monitors, for example).
- ◆ Always wind the tape to the beginning when you have finished. Store with the full spool at the bottom and with the cassette in its cover.

You can protect your precious recordings from being wiped by breaking out the safety tab on the side of the cassette (some cassettes have a slide).

Should you wish to re-use the tape after removing the tab, cover the hole with adhesive tape.

Recording/Playback Time of Video Type

Type	Maximum Recording/Playback Time	
	SP Mode (Standard Play)	LP Mode (Long Play)
E-30	30min	1 hour
E-60	1 hour	2 hours
E-90	1 hour 30 minutes	3 hours
E-120	2 hours	4 hours
E-180	3 hours	6 hours
E-240	4 hours	8 hours

V-Lock



When changing to STILL mode while the tape is playback, the vertical synchronization may sometimes be shaken according to the tape condition. At this time, use this key for the better picture screen.

Child Lock



Choose "MISCELLANEOUS" of "MAIN MENU".

You can prevent use of the TV set without the remote control.

The set is child-locked after you input any four figure secret number subsequently the TV picture will be overlaid with the words child locked and the sound will be muted.

Mute

Pressing the MUTE() button once turns the sound off. The sound returns if button is pressed once more. The mute maintains when you press PR  / .

MORE functions

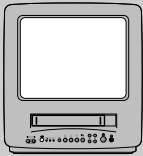

Picture adjustments

MENU

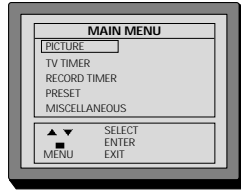

Call up the televido's "MAIN MENU".

STOP

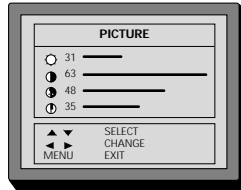

Choose "PICTURE".

What do you want to adjust?

- ◆ brightness ☼
- ◆ contrast ◐
- ◆ colour 🌈
- ◆ sharpness Ⓢ



Adjust.

MENU

Close the menu.

Picture type selection

NORMAL

When you press the NORMAL button repeatedly you can call up three picture setting; for NORMAL 1 (hard picture), NORMAL 2 (soft picture), FAVOURITE (adjustable picture).

- ◆ The last set value is automatically stored in FAVOURITE mode.
- ◆ Note that if you set the brightness and contrast values too low, the on-screen-display become dark.

Changing on-screen displays

RECALL
1-3x

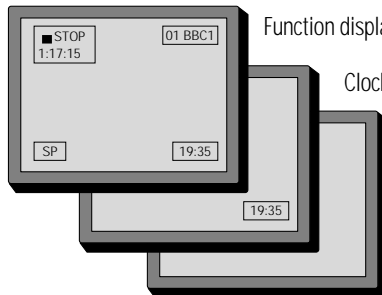

Function display.

Clock display.

No display.

M O R E f u n c t i o n s

- ◆ You can program your televideo so that it switches on and/or off (with the selected station) at a time you want.

Television timer

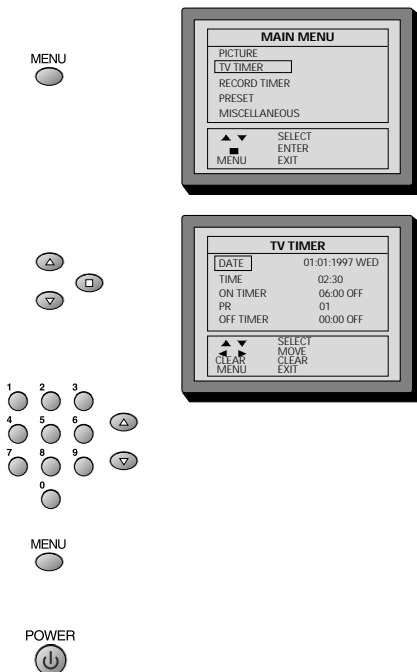

Call up the televideo's main "MAIN"

Choose "TV TIMER".

Type in:

- ◆ the switch on time
- ◆ the station number
- ◆ the switch off time

N.B. Ensure on timer OFF is set to on and OFF timer OFF is set to on.

Store leaving the menu.

You can switch your televideo off (stand-by)
(Do not use the main power button on the front panel of the set.)

Snooze automatic



You can set your televideo to automatically switch off after a period of 10 to 120 minutes.

Press the button repeatedly.



- ◆ In TV mode, if the broadcasting signal is not continuously present, for approx. 30minutes, the TV receiver will automatically power off.
- ◆ The "TV TIMER" only works if no "VIDEO TIMER" is programmed.
- ◆ Adjusting the "ON TIMER" once will cause the televideo to switch on every day at the same time (till you clear or change the setting.)
- ◆ You can programme "ON TIME" (including "PR") and/or "OFF TIME".

MORE functions

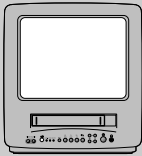

- ◆ If you wish to use the VideoPlus+ system for programming timer recordings, you must first allocate the 3-digit VideoPlus+ guide numbers to each corresponding station number. These are given in those TV guides that publish the VideoPlus+ numbers.

VideoPlus+ guide numbers

MENU

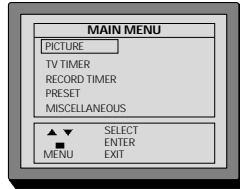

Call up the televideo's "MAIN MENU".

▲

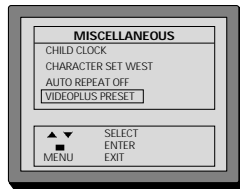

Choose "MISCELLANEOUS".

▼

▲

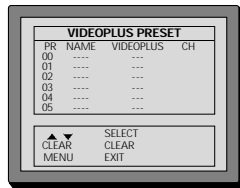

Choose "VIDEOPLUS PRESET".

▼

1 2 3
4 5 6
7 8 9
0

Type in the guide number corresponding to each station (number) you have stored. E.g. if you have stored BBC1 on 01 then put 001 against 01 and if you have stored BBC2 on 02 then put 002 against 02 however. If you wish to record a satellite programme using videoplus+ you have to insert each code against the programme no E.G. If you have SKY1 under station number "TV PR" 06 then type in the guide number for SKY1 which is 101, against 06.

▼

To move to the next station number.

CLEAR EX

○

To clear a wrong input.

MENU

○

Store leaving the menu.

M O R E f u n c t i o n s

Teletext

SWITCHING TELETEXT ON/OFF

Press the TELETEXT button (☐), the index page viewed last will appear. Press the TELETEXT button to return to the TV mode.

COLOUR BUTTONS IN TOP/FLOF TELETEXT

A red, green, yellow and cyan field is shown at the bottom of the screen.

If TOP of FLOF teletext (FASTEXT) is transmitted by the station, pressing the corresponding colour button on the remote controller, you can select the desired page easily.

SELECTING PAGES

The NUMBER button 0...9 are used to enter a page number.

The selected page number appears at the top of the screen and the page appears after a short time.

The UP/DOWN buttons increase or decrease the current page number by 1.

INDEX PAGE

You can switch directly to the programme preview (with TOP text) or the overview page of the station you are currently viewing by pressing the INDEX (☐) button.

PAGE HOLD

Several sub pages can be combined under a page number and are scrolled at an interval determined by the TV station.

The presence of sub pages is indicated by, for example, 3/6 beneath the time, which means that you are looking at the 3rd page of a total of 6 pages.

If you want to look at a subpage for a longer period of time, press the HOLD (☐) button. The contents of the subpage shown are kept on the screen and no longer updated or switched to other subpages. Pressing the HOLD button again, the current subpage appear.

CALLING UP SUBPAGE DIRECTLY

Pressing the SUBPAGE (☐) button "Page no/..."

appears at the bottom of the screen. Enter the subpage number that you want to call up with the NUMBER button 0...9, for example the 2nd page, sequence 0002. The desired subpage is sought and displayed. To exit, press SUBPAGE (☐) button again.

WATCHING TELEVISION DURING TELETEXT MODE

Some pages are continually updated, for example, stock market reports, sports announcements, and the latest news. If you want to watch TV and stay informed at the same time, press CANCEL (☐) button.

The regular programme is still visible and the teletext symbol (☐) appears at the top of the screen. Pressing the CANCEL button again, the teletext page appears with the update information.

REVEAL ANSWER

This function can be used on certain pages to reveal the solution of riddles. Press the REVEAL button (☐) to reveal a hidden answer and press again to hide it.

TV/TELETEXT ☐

Watch the TV programme and the Teletext pages simultaneously. The next press returns to the normal display.

CONTRAST AND BRIGHTNESS CONTROL IN TELETEXT MODE

Press the MENU button in teletext mode, the contrast and brightness control menu will be displayed in the bottom of the screen. You can adjust contrast and brightness using the corresponding colour button on the remote controller.

DOUBLING CHARACTER SIZE

Repeatedly pressing the SIZE button (☐) doubles the character size in the following order:

Upper half of the page → LOWER half of the page → Return to normal size.

Teletext character set

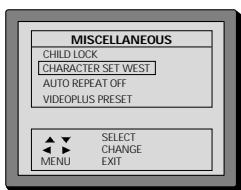

Choose "CHARACTER SET WEST" press ◀/▶ buttons.



CONNECTIONS and copying

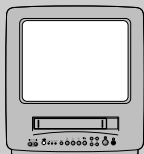

◆ Switch off all components when connecting or disconnecting cables.

Copying



To copy to your televideo **from another video machine**, connect the two machines with a cable between their AV sockets and select as programme "AV1" (EURO AV, SCART)

Using the button.

Set the other video machine to playback and your Daewoo machine to record.

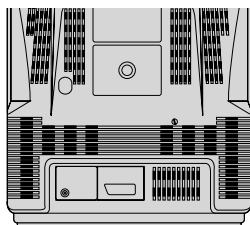

Picture and sound of the selected station is always available on the EURO AV (SCART) socket, e.g. to record with another VCR.

On the other video, select its AV input and set the machine to record.

Switch your televideo to play back at the position you want copying to start.

Assembling

Should you wish to assemble your own film, from camcorder footage for example, use the assembly technique for smooth edit points:

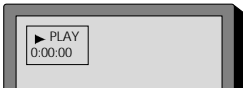
- 

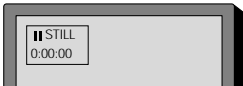
◆ Move the tape to the position at which the new scene is to be added using the play functions (pages 12/13).
- 

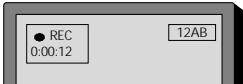
◆ Wind back slightly before the edit point and put the machine into pause using the PAUSE button (do not press STOP!).
- 

◆ Now go directly into record.

For the best results, the source cassette from which you are recording should already be playing back when you start recording.

CONNECTIONS

and copying

Scart socket

This is used to connect : a VCR, a Camcorder and a video game console or satellite TV receiver.
In most case, the set changes automatically to AV mode, when the VCR connected is in playback mode.
If not, press the AV button on the remote controller.

The AV will be displayed on the screen with the current programme number.

In AV mode, you can change the TV programme number with the ▲/▼ button or the NUMBER button 0-9.

Note that it's impossible to control the functions excepting the volume control and mute function in the AV mode. You must turn the external equipment off to return to the TV mode.

21 PIN EURO-SCRAT

PIN	Signal Designation	Matching Values
1	Audio Out (linked with 3)	0.5Vrms, Imp < 1k Ω (RF 60% MOD)
2	Audio In (linked with 6)	0.5Vrms, Imp > 10k Ω
3	Audio Out (linked with 1)	0.5Vrms, Imp < 1k Ω (RF 60% MOD)
4	Audio Earth	
5	Blue Earth	
6	Audio in (linked with 2)	0.5Vrms, Imp > 10k Ω
7	Blue in	0.7Vpp \pm 3dB, Imp 75 Ω
8	Slow (Function) Switching	TV:0-2V, PERI:9.5-12V, Imp > 10k Ω
9	Green Earth	
10	NC	
11	Green In	0.7Vpp \pm 3dB, Imp 75 Ω
12	NC	
13	Red Earth	
14	NC	
15	Red In	0.7Vpp \pm 3dB, Imp 75 Ω
16	Rapid (Blanking) switching	Logic 0:0-0.4V, Logic 1:1-3V, Imp 75 Ω
17	Video Earth	
18	Rapid Blanking Earth	
19	Video Out	1Vpp \pm 3dB, Imp 75 Ω
20	Video In	1Vpp \pm 3dB, Imp 75 Ω
21	Common Earth	

APPENDIX

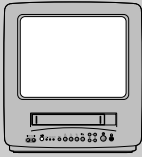

Before you ask a specialist

Mains supply

the televideo's power indicator does not light your televideo doesn't work

- The mains lead is not connected to the wall socket.
- Condensation may have formed when moving the televideo from a cold to a warm room. Wait until the video (and cassette!) reach room temperature.

Recording

doesn't start
the cassette starts playback or is ejected

- Is a cassette loaded?
- The safety tab may be missing. Cover the hole with adhesive tape (page 21).

Playback

no picture

- Are the TV stations tuned in on your televideo (pages 7-9)?
- Is there a recording on the video tape?
- Use PR/TRK buttons to adjust tracking if horizontal stripes appear.
- Is the cassette of poor quality or worn out? Test with another cassette.

poor picture quality

- Try a different cassette. The video head drum may need cleaning - ask your dealer.
- Press PAUSE several times. Adjust with the VOL/V.LOCK buttons until you get the best picture.

poor still picture

Remote control doesn't work

- Are the batteries run down?
- Is the distance between remote control and televideo more than 7 metres?
- Is there an object blocking the direct line between remote control and televideo?

General

a cassette won't load
the cassette won't rewind,
fast forward, play or record
timer is recording incorrectly
a loud noise when left in Stop mode

- Is there a cassette already loaded?
- The cassette is already fully wound back or to the end.
- Is the clock set correctly (page 7)?
- If no play or record function is used for about five minutes when left in Stop mode, the televideo switches its motor off to conserve the mechanism.

We strive to continuously improve our products – we therefore reserve the right to make technical changes without notice. The information contained in this booklet is therefore subject to change and is not legally binding.

APPENDIX

Playing back



Start playback.



Stop playback.



Eject the cassette.



Fast forward or rewind the cassette from stop.



Still picture from playback.
Each press of the button advances the picture one frame.
PLAY (▶) switches back to normal playback.



Starting from playback you can control search speed in 2 steps either forwards (▶▶) or backwards (◀◀). Press repeatedly.
PLAY (▶) switches back to normal playback.

Auto tracking



If you press the A.TRK key in PLAYBACK mode, the TVCR will operate the auto tracking function again.

Simple recording

Load a cassette with its safety tab in place (see page 21).



Choose the station whose programme you want to record.



If the programme you wish to record is very long, double the possible recording time with "LP" (Long Play). Up to eight hours with an E240 cassette.



Start your recording



If you wish to interrupt recording briefly - then continue.



Stop your recording.

One touch recording = OTR



Choose the station you want and press the button once for every 30 minutes of programme you wish to record.

APPENDIX

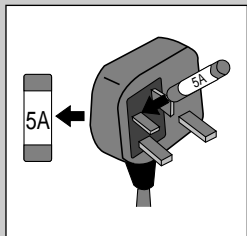
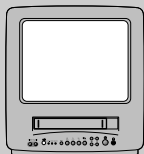

Index

Aerial	6	OTR	14
Assembling recordings	26	Overlaps	16
Child Lock	21	Picture type	22
Cleaning	Precautions	Satellite	19
Condensation	Precautions	SCART socket	27
Counter	20	SP (Standard Play)	14
Euro AV	26	Stand-by	Precautions
Fine-tuning	10	Station	9
LP (Long Play)	14	Tracking	29
Menu	7	VideoPlus+	15
NTSC	13		

Technical data

Dimensions

W x H x D
 14" : 445 x 425 x 426 20" : 574 x 582 x 534
 21" : 646 x 598 x 540

Weight
 14" : 13.8Kg 20" : 23.6Kg 21" : 26.2Kg

Power supply

Voltage AC 220-240V~, 50Hz
 Power consumption 14" : 68W 20" : 78W 21" : 85W

System

Video PAL (U.K.), NTSC PLAYBACK
 Channel range VHF-L:CH E2 - S7 VHF-H:CH S8-S36 UHF:CH S37-E69
 Channel locations 70 + AUX

Video

System VHS / 2 heads
 Speeds SP/LP

General

Temperature range 5-35°C
 Humidity range < 80%
 Timer 6 events, 1 month
 Remote control infrared, 2x1.5V, AAA size

Subject to technical alterations without notice.

Your product guarantee

Dear Customer

Thank you for buying this Daewoo product. In the unlikely event of a failure all repair work will be carried out by your retailer or Daewoo approved service centre, for a period of 12 month from date of sale.

Daewoo Electronics Sales UK Ltd., will provide the following services in order to expedite this guarantee.

During this period should a fault occur due to improper materials or workmanship, the retailer, authorised service centre, or authorised service dealer will carry out repairs at no cost to yourself. Replacement products will be offered at the discretion of your supplying dealer.

This guarantee will be honoured by Daewoo service networks in other E.C. members states, in accordance with the terms and conditions which prevail in the member state at the time service is requested.

Conditions

Any claims made under the terms of the guarantee must be supported by the original invoice/bill of sale issued at the time of sale. Daewoo reserve the right to refuse guarantee should any of the information on the bill of sale be removed or changed in any way after the original purchase of the product by the consumer from the retailer.

Modifications or adjustments made to the product which enable it to conform to local technical or safety standards in force in any country other than the one for which the product was originally designed and manufactured, are not included in this guarantee. Failures arising from such modifications, whether performed properly or not, will not be covered by this guarantee.

This guarantee does not cover any of the following :

- 1) Periodic maintenance, the repair or replacement of parts due to normal wear and tear.
- 2) Home service transport cost, and other costs and risks of transport relating directly or indirectly to the guarantee of the product.
- 3) Damage to this product resulting from : the above and misuse, including but not limited to the failure to this product for its normal purpose or in accordance with the instructions on the proper use and maintenance of this product, and the installation or the use of this product in a manner inconsistent with the technical or safety standards in force in the country where the product is used.
- 4) Repairs carried out by non-authorised service centres.
- 5) Accidents, acts of God, or any cause beyond the control of Daewoo including but not limited to lightning, water, fire and improper ventilation.
- 6) Aerial alignment and consumer control adjustments.
- 7) Batteries whether supplied by Daewoo or not which become worn or exhausted in use.
- 8) Loss or damage caused to any item or article used with this product. This includes (but not limited to) discs, tapes, records, and films.

This guarantee does not affect your statutory rights as a consumer, nor your rights against the retailer, arising from their sales or purchase contract.

In the absence of applicable legislation, this guarantee will be the consumers sole and exclusive remedy, and neither Daewoo nor its subsidiary, or distributor shall be liable for any incidental or consequential damages for breach of any express or implied guarantee of this product.

For further information regarding this or any other query you may have about Daewoo products or its services please write to :

Daewoo Electronics Sales UK Limited
Daewoo Building, Wharfedale Road,
Winnersh Triangle Wokingham,
Berkshire, RG41 5TP. UK
Tel : 01189 252 577
Fax : 01189 699 000

In all cases of difficulty - consult your Daewoo dealer from whom the product was purchased.

APPENDIX

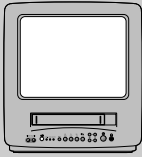

Your product guarantee

Your televideo is not intended for industrial use. It is designed specifically for domestic purpose.

DAEWOO

DAEWOO ELECTRONICS SALES UK LIMITED

Daewoo Building, Wharfedale Road
Winnersh Triangle Wokingham
Berkshire, RG41 5TP. UK

Tel : 01189 252 577

Fax : 01189 699 000

Dear Customer

Thank you for buying this Daewoo product. In the unlikely event of a failure all repair work will be carried out by your retailer or Daewoo approved service centre, for a period of 12 month from date of sale.

Daewoo Electronics Sales UK Ltd., will provide the following services in order to expedite this guarantee.

During this period should a fault occur due to improper materials or workmanship, the retailer, authorised service centre, or authorised service dealer will carry out repairs at no cost to yourself. Replacement products will be offered at the discretion of your supplying dealer.

This guarantee will be honoured by Daewoo service networks in other E.C. members states, in accordance with the terms and conditions which prevail in the member state at the time service is requested.

DAEWOO GUARANTEE

Serial No.

Model No.



Conditions

Any claims made under the terms of the guarantee must be supported by the original invoice/bill of sale issued at the time of sale. Daewoo reserve the right to refuse guarantee should any of the information on the bill of sale be removed or changed in any way after the original purchase of the product by the consumer from the retailer.

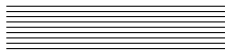

Modifications or adjustments made to the product which enable it to conform to local technical or safety standards in force in any country other than the one for which the product was originally designed and manufactured, are not included in this guarantee. Failures arising from such modifications, whether performed properly or not, will not be covered by this guarantee.

This guarantee does not cover any of the following :

- 1) Periodic maintenance, the repair or replacement of parts due to normal wear and tear.
- 2) Home service transport cost, and other costs and risks of transport relating directly or indirectly to the guarantee of the product.
- 3) Damage to this product resulting from : the above and misuse, including but not limited to the failure to this product for its normal purpose or in accordance with the instructions on the proper use and maintenance of this product, and the installation or the use of this product in a manner inconsistent with the technical or safety standards in force in the country where the product is used.
- 4) Repair carried out by non-authorized service centres.
- 5) Accidents, acts of God, or any cause beyond the control of Daewoo including but not limited to lightning, water, fire and improper ventilation.
- 6) Aerial alignment and consumer control adjustments.
- 7) Batteries whether supplied by Daewoo or not which become worn or exhausted in use.

This guarantee does not affect your statutory rights as a consumer, not your rights against the retailer, arising from their sales or purchase contract.

In the absence of applicable legislation, this guarantee will be the consumers sole and exclusive remedy, and neither Daewoo nor its subsidiary, or distributor shall be liable for any incidental or consequential damages for breach of any express or implied guarantee of this product.

For further information regarding this or any other query you may have about Daewoo products or its services please write to :

Daewoo Building, Wharfedale Road
Winnersh Triangle Wokingham
Bershire, RG41 5TP. UK

Tel : 01189 252 577
Fax : 01189 699 000



Free Manuals Download Website

<http://myh66.com>

<http://usermanuals.us>

<http://www.somanuals.com>

<http://www.4manuals.cc>

<http://www.manual-lib.com>

<http://www.404manual.com>

<http://www.luxmanual.com>

<http://aubethermostatmanual.com>

Golf course search by state

<http://golfingnear.com>

Email search by domain

<http://emailbydomain.com>

Auto manuals search

<http://auto.somanuals.com>

TV manuals search

<http://tv.somanuals.com>