

DAEWOO
ELECTRONICS CORP.

DVD PLAYER
OWNER'S MANUAL
DVG-5200S

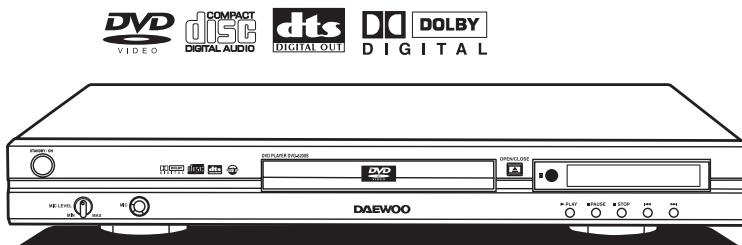



TABLE OF CONTENTS

IMPORTANT SAFETY PRECAUTIONS	2	PLAY DISCS IN VERIOUS WAYS	25
FEATURES	6	Select Angle.....	25
ABOUT MANUAL	7	Zoom Play.....	25
TERMS FOR DISCS	8	Book Mark.....	25
BEFORE OPERATION	10	Program Play (DVD).....	26
PREPARATIONS BEFORE OPERATION	12	Program Play (CD)	26
Front Panel	12	Digest Play (DVD)	27
Rear Panel	13	Digest Play (something disc).....	27
VFD	14	Digest Play (CD).....	27
Names and Layout of Remote Controls	15	Play MP3 or PIC-CD Disc.....	28
CONNECTIONS	16	FUNCTION SETTING	30
BASIC OPERATIONS	17	Menu Setting	30
Play Discs.....	17	Basic Navigation.....	31
System Setting.....	18	Setup Menu	31
V-Mode.....	18	General Setup.....	32
Display.....	18	Dolby Digital Setup.....	34
Fast Play	19	Preference Setup.....	34
Slow Play.....	19	OTHERS	36
Step/ Pause.....	19	Ton Control.....	36
Select Audio Language	20	Troubleshooting.....	37
Select Channels	20	Technical Specifications.....	38
Selecting 3D Audio	20		
PLAYING A DESIRED SCENE	21		
To skip scenes in a disc.....	21		
Directly moving to a desired title (DVD).....	21		
Playing a disc containing MP3 files	22		
Repeat Play.....	22		
Repeating a defined period from A to B	23		
Select a Subtitle Language	23		
Searching	24		

IMPORTANT SAFETY PRECAUTIONS

	CAUTION RISK OF ELECTRIC SHOCK DO NOT OPEN	
<p>CAUTION: TO REDUCE THE RISK OF ELECTRIC SHOCK, DO NOT REMOVE COVER (OR BACK). NO USER-SERVICEABLE PARTS INSIDE. REFER SERVICING TO QUALIFIED SERVICE PERSONNEL.</p>		



The lightning flash with arrowhead symbol, within an equilateral triangle, is intended to alert the user to the presence of uninsulated "dangerous voltage" within the product's enclosure that may be of sufficient magnitude to constitute a risk of electric shock.



The exclamation point within an equilateral triangle is intended to alert the user to the presence of important operating and servicing instructions in the literature accompanying the appliance.

WARNING : TO REDUCE THE RISK OF FIRE OR ELECTRIC SHOCK, DO NOT EXPOSE THIS APPLIANCE TO RAIN OR MOISTURE.
CAUTION : TO PREVENT ELECTRIC SHOCK, MATCH WIDE BLADE OF PLUG TO WIDE SLOT, FULLY INSERT.

IMPORTANT FOR LASER PRODUCTS

- LASER :** This Digital Video Disc Player employs a Laser System. To ensure proper use of this product please read this owner's manual carefully and retain for future reference. Should the unit require maintenance, contact an authorized service location - see service procedure.

Use of control adjustments or the performance of procedures other than those specified may result in hazardous radiation exposure.

To prevent direct exposure to the laser beam, do not try to open the enclosure. Visible laser radiation when open and interlocks defeated.

DO NOT STARE INTO THE BEAM.
- DANGER :** Visible laser radiation when open and interlock failed or defeated. Avoid direct exposure to beam.
- CAUTION :** Do not open the top cover. There are no user serviceable parts inside the Unit; leave all servicing to qualified service personnel.

**CLASS 1
LASER PRODUCT**

CAUTION: Any changes or modification in construction of this device which are not expressly approved by the party responsible for compliance could void the user's authority to operate the equipment.

ATTENTION: KEEPING THE STATUS OF STOP MORE THAN 5 MINUTES ENTERS SCREEN SAVE MODE. WHEN THE SCREEN SAVE MODE IS KEPT MORE THAN AN HOUR, THE SET ENTERS STAND-BY MODE.

MACROVISION

This product incorporates copyright protection technology that is protected by method claims of certain U.S. patents and other intellectual property rights owned by Macrovision Corporation and other rights owners. Use of this copyright protection technology must be authorized by Macrovision Corporation, and is intended for home and other limited viewing uses only unless otherwise authorized by Macrovision Corporation. Reverse engineering or disassembly is prohibited.

IMPORTANT SAFETY PRECAUTIONS

This set has been designed and manufactured to assure personal safety. Improper use can result in electric shock or fire hazard. The safeguards incorporated in this unit will protect you if you observe the following procedures for installation, use and servicing. This unit is fully transistorized and does not contain any parts that can be repaired by the user.

1 READ INSTRUCTIONS

All the safety and operating instructions should be read before the unit is operated.

2 RETAIN INSTRUCTIONS

The safety and operating instructions should be retained for future reference.

3 HEED WARNINGS

All warnings on the unit and in the operating instructions should be adhered to.

4 FOLLOW INSTRUCTIONS

All operating and use instructions should be followed.

5 CLEANING

Unplug this unit from the wall outlet before cleaning. Do not use liquid cleaners or aerosol cleaners. Use a damp cloth for cleaning.

6 ATTACHMENTS

Do not use attachments unless recommended by the unit's manufacturer as they may cause hazards.

7 WATER AND MOISTURE

Do not use this unit near water- for example, near a bath tub, wash bowl, kitchen sink or laundry tub, in a wet basement, or near a

swimming pool.

*PORTABLE CART WARNING
(symbol provided by RETAC)*

8 ACCESSORIES

Do not place this unit on an unstable cart, stand, tripod, bracket, or table. The unit may fall, causing serious injury to a child or adult as well as serious damage to the unit. Use this unit only with a cart, stand, tripod, bracket, or table recommended by the manufacturer.

**8A**

A unit and cart combination should be moved with care. Quick stops, excessive force, and uneven surfaces may cause the video product and cart combination to overturn.

9 VENTILATION

Slots and openings in the case are provided for ventilation to ensure reliable operation of the unit and to protect it from overheating. These openings must not be blocked or covered. These openings must not be blocked by placing the unit on a bed, sofa, rug, or other similar surface. This unit should never be placed near or over a radiator or heat radiator. This unit should not be placed in a built-in installation such as a bookcase or rack unless proper ventilation is provided or the manufacturer's instructions have been adhered to.

10 POWER SOURCES

This unit should be operated only from the type of power source indicated on the marking label. If you are not sure of the type of power supply to your home, consult

IMPORTANT SAFETY PRECAUTIONS

your video dealer or local power company. For units intended to operate from battery power, or other sources, refer to the operating instructions.

11 GROUNDING OR POLARIZATION

This unit is equipped with a polarized alternating -current line plug (a plug having one blade wider than the other). This plug will fit into the power outlet only one way.

This is a safety feature. If you are unable to insert the plug fully into the outlet, try reversing the plug. If the plug still fails to fit, contact your electrician to replace your obsolete outlet. To prevent electric shock, do not use this polarized plug with an extension cord, receptacle, or other outlet unless the blades can be fully inserted without blade exposure. If you need an extension cord, use a polarized cord.

12 POWER-CORD PROTECTION

Power-supply cords should be routed so that they are not likely to be walked on or pinched by items placed upon or against them, paying particular attention to cords at plugs, convenience receptacles, and the point where they exit from the unit.

13 LIGHTNING

For added protection for this unit during a lightning storm, or when it is left unattended and unused for long periods of time, unplug it from the wall outlet and disconnect the antenna or cable system. This will prevent damage to the unit due to lightning and power line surges.

14 DISC TRAY

Keep your fingers well clear of the disc as it is closing. It may cause serious personal injury.

15 OVERLOADING

Do not overload wall outlets of extension cords as this can result in a risk of fire or electric shock.

16 OBJECT AND LIQUID ENTRY

Never push objects of any kind into this unit through openings as they may touch dangerous voltage points or "short-out" parts that could result in a fire or electric shock. Never spill liquid of any kind on the unit.

17 BURDEN

Do not place a heavy object on or step on the product. The object may fall, causing serious personal injury and serious damage to the product.

18 DISC

Do not use a cracked, deformed or repaired disc. These discs are easily broken and may cause serious personal injury and product malfunction.

19 SERVICING

Do not attempt to service this unit yourself as opening or removing covers may expose you to dangerous voltage or other hazards. Refer all servicing to qualified service personnel.

IMPORTANT SAFETY PRECAUTIONS

20 DAMAGE REQUIRING SERVICE

Unplug this unit from the wall outlet and refer servicing to qualified service personnel under the following conditions.

- A. When the power-supply cord or plug is damaged.
- B. If liquid has been spilled, or objects have fallen into the unit.
- C. If the unit has been exposed to rain or water.
- D. If the unit does not operate normally by following the operating instructions. Adjust only those controls that are covered by the operating instructions. Improper adjustment of other controls may result in damage and will often require extensive work by a qualified technician to restore the unit to its normal operation.
- E. If the product has been dropped or the cabinet has been damaged.
- F. When the unit exhibits a distinct change in performance-this indicates a need for service.

21 REPLACEMENT PARTS

When replacement parts are required, have the service technician verify that the replacements he uses have the same safety characteristics as the original parts. Use of replacements specified by the unit manufacturer can prevent fire, electric shock, or other hazards.

22 SAFETY CHECK

Upon completion of any service or repairs to this unit, ask the service technician to

perform safety checks recommended by the manufacturer to determine that the unit is in safe operating condition.

23 WALL OR CEILING MOUNTING

The product should be mounted to a wall or ceiling only as recommended by the manufacturer.

24 HEAT

The product should be situated away from heat sources such as radiators, heat registers, stoves, or other products (including amplifiers) that produce heat.



FCC NOTICE :

This equipment has been tested and found to comply with the limits for a Class B digital device, pursuant to part 15 of the FCC Rule. These limits are designed to provide reasonable protection against harmful interference in a residential installation. This equipment generates, uses and can radiate radio frequency energy and if not installed and used in accordance with the instructions, may cause harmful interference to radio communications. However, there is no guarantee that interference will not occur in a particular installation. If this equipment does cause harmful interference to radio or television reception; which can be determined by turning the equipment off and on, the user is encouraged to try to correct the interference by one or more of the following measures:

- Reorientate or relocate the receiving antenna.
- Increase the separation between the equipment and receiver.
- Connect the equipment to an outlet on a circuit different from that to which the receiver is connected.
- Consult the dealer or an experience radio/TV technical for help.

FEATURES

④ OUTSTANDING SOUND QUALITY

Dolby Digital  system developed by Dolby Laboratories and DTS  developed by DTS Inc., features high quality surround sound, can be played in DVD or CD disc at home, to reproduce high quality sound effects.

④ HIGH DEFINITION

The unit adopts MPEG2 coding format and brings the high horizontal resolution.

④ UNIQUE FUNCTIONS

Multi-angle and multi-language bring unique trick functions.
Parent lock makes it easy to control the content of discs.

④ SCREEN

Ordinary screen and wide screen (16:9) are available.

④ COMPATIBILITY

The unit can play DVD discs, and is compatible with CD, CD-R, CD-RW, PIC-CD and MP3 discs.

④ ZOOM

It can enlarge pictures or reduce pictures.

④ MULTI-FUNCTIONS

Fast forward, fast reverse, forward and reverse slow, frame play, repeat play and program play.

④ TIME SEARCH

It can search a specific part on a disc, especially good for watching fiction movies.

④ RESUME PLAY

It can memorize the position where the disc is stopped and resume playback.

④ VIDEO OUTPUT

Standard video, S-video signal output mode, component video output mode.

④ AUDIO OUTPUT

Analog audio output, coaxial and optical digital audio output, can be connected with the appropriate amplifier to enjoy high-quality sound effects.

④ KARAOKE

Microphone input, KARAOKE channel selection.

ABOUT MANUAL

■ PRINCIPLES FOR WRITING

This manual mainly introduces how to use buttons on the remote control.
You may operate the unit if the buttons on the unit have the same or similar names as or to those on the remote control.

■ PLAYABLE DISCS

- DVD and Audio CD

Disc type	Playable	Restriction
DVD	Possible	Region number 1 or Region number All
CD	Possible	PCM or DTS digital out
CD-G	Possible	Only Audio playback
CD-ROM	Possible	MP3 File
CD-R	Possible	CD/CD-ROM (MP3 File)
CD-RW	Possible	CD/CD-ROM (MP3 File)
DVD-R	Possible	DVD Video
DVD-ROM	Impossible	DVD Video
DVD-RAM	Impossible	
DVD+RW	Impossible	
DVD-RW	Impossible	
Photo CD	Impossible	

TERMS FOR DISCS

■ TITLE

The images or music of a DVD are divided into some units, among which title is the biggest one.

When playing a DVD, the movie is the title.

When playing a CD, the combined tracks make up the title.

■ CHAPTER

It is smaller than title among the units of a DVD. A title is made up of several chapters, and each chapter has a number for search. But some discs may not have numbered chapters.

■ TRACK

In a CD, each track has a number to enable search functions.

■ STRUCTURE OF DVD

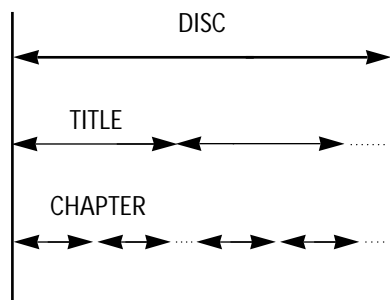

■ STRUCTURE OF CD

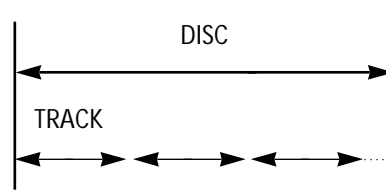

TERMS FOR DISCS**SCENE**

The menu pictures, motion and motionless pictures of a CD or something discs with PBC function can be divided into some parts, these parts are scenes. Each scene has a number for search.

PBC (PLAYBACK CONTROL)

It is signals recorded in a CD or something discs to control playback.

DISC TYPE	FUNCTION
disc without PBC	enjoy music and images (motion pictures)
disc with PBC	Besides the images of special disc, play interactive software with the menu pictures shown on the TV screen (PBC play). If the disc has motionless pictures, high-resolution playback is also available.

REGION MANAGEMENT INFORMATION

This unit is designed and manufactured to respond to the Region Management information that is recorded on a DVD disc. The region number of this player is "1". If the region number described on the DVD discs does not correspond to the Region number of this player, the player will not play this disc. This player will play DVD discs made for "ALL" regions. Therefore, this player will play DVD discs marked with labels containing the region number "1" or "ALL".



(Region 1)



(Region ALL)

BEFORE OPERATION

■ SECURITY

- Before operation, check if the voltage of the unit is in line with the local voltage.
- Hold the plug to disconnect it from the mains outlet. Do not pull the power cord.
- When the plug of the unit is connected to the mains outlet, the unit will be still connected to AC even if the power is turned off.
- Disconnect the plug as soon as liquid or objects enter the unit. The unit can not be used until being checked by experts.
- Do not open the cabinet as laser rays employed by the unit may damage eyes. Any servicing should be done by qualified service personnel.

■ PLACEMENT

- Put the unit where ventilation is good enough to prevent overheating.
- Never put the unit in direct sunlight or near heat sources.
- Put the unit horizontally, never put any heavy object on the unit.
- To protect the pickup, do not put the unit where there is dust. If there is dust on the pickup, use a cleaning disc to clean it. Paying particular attention to the operating instructions of the cleaning disc.

■ CONDENSATION

Moisture will appear on the pickup lens in the following cases:

- The unit is suddenly moved from a cold place to a warm place.
- The unit is put in a room with a heater, or in cold air from an air-conditioner.
- Using the unit in a humid place. In these cases, the unit can not work. Unload the disc and leave the unit on for about one hour to evaporate the moisture.

■ CLEANING

- Use a soft cloth with a little neutral detergent to wipe the cabinet, panel and controls.
Never use abrasive paper, polishing powder, solvent like alcohol or gasoline.

BEFORE OPERATION**HANDLING DISC**





- To keep the disc clean, do not touch the playsides of the disc.
- Do not attach paper or tape to the disc.
- Keep the disc away from direct sunlight or heat sources.
- Store the disc in a disc case after playback.

CLEANING DISC

- Before playback, wipe the disc outwards from the centre with clean cloth.
- Do not use any type of solvent such as thinner, benzine, commercially available cleaners or antistatic spray.

CHECK ACCESSORIES

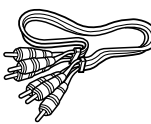
Check if you have all the accessories after the carton is opened.

Remote control	AAA batteries	Video/Audio cord	Owner's manual
			

USE REMOTE CONTROL

Check if you have all the accessories after the carton is opened.

1. Open the battery compartment.
2. Insert two AAA batteries, make sure to match "+" and "-" of the batteries to the marks in the battery compartment.
3. Close the battery compartment.
4. Point the remote control at the remote sensor.

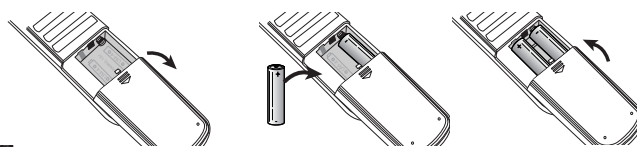

Note:

1. Batteries can last for about 6 months generally. Change the batteries of that does not work.
2. If the remote control is not used for a long time, remove the batteries to prevent battery leakage.

PREPARATIONS BEFORE OPERATION

FRONT PANEL

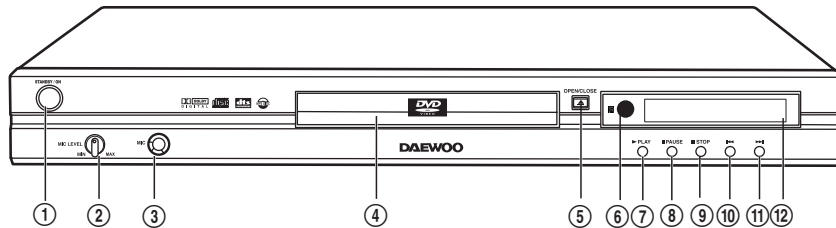

- ① STANDBY/ON button
To switch the unit On or Off when connected to AC power outlet
- ② Microphone Level adjustment knob.
- ③ Microphone Jack
- ④ TRAY DOOR
Press OPEN/CLOSE button to open it.
- ⑤ OPEN/CLOSE button
To open or close the disc tray.
- ⑥ Remote Sensor
- ⑦ PLAY button
To play the loaded disc. Press this button to go to the preferred item when the menu is displayed on the TV screen.
- ⑧ PAUSE
Press this button in playback mode, the picture stops. This machine enters the playback pause mode.
- ⑨ STOP
- ⑩ One Chapter/Track backward button
To skip back from the status.
- ⑪ One Chapter/Track forward button
To skip forward to the status. If playing a disc with PBC, this button works as the NEXT button to move to the next play list.
- ⑫ DISPLAY
Displays operation status

PREPARATIONS BEFORE OPERATION

REAR PANEL

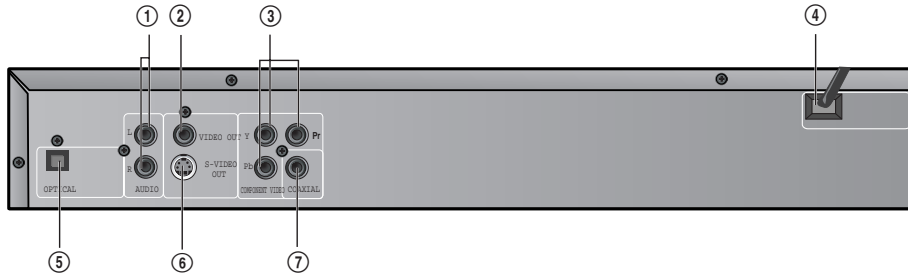

- ① **AUDIO OUT (L/R TRACK)**
Two phono sockets for analogue 2 Channel audio in order to a TV or stereo amplifier.
- ② **VIDEO OUT**
Connects composite video signal to input AV or PHONO sockets of TV or monitor to achieve high fidelity colour reproduction.
- ③ **COMPONENT(Y.Pb.Pr)**
Connects to TV or monitor equipped with Component input . In order to achieve a sharper and cleaner picture than that when connected via VIDEO OUT (composite video).
- ④ **POWER SUPPLY SOCKET WIRE**
Creates POWER between wall outlet and the unit.
- ⑤ **DIGITAL AUDIO OPTICAL OUT**
Connects digital audio under play mode into an AV amplifier or a receiver equipped with digital audio decoder for you to enjoy the theater-quality sound in your home.
- ⑥ **S-VIDEO OUTPUT**
Connects to TV or monitor equipped with S-VIDEO input. In order to achieve a sharper and cleaner picture than that when connected via VIDEO OUT (composite video).
- ⑦ **DIGITAL AUDIO COAXIAL OUT**
Connects digital audio under play mode into an AV amplifier or a receiver equipped with digital audio decoder for you to enjoy the theater-quality sound in your home.

PREPARATIONS BEFORE OPERATION

VFD

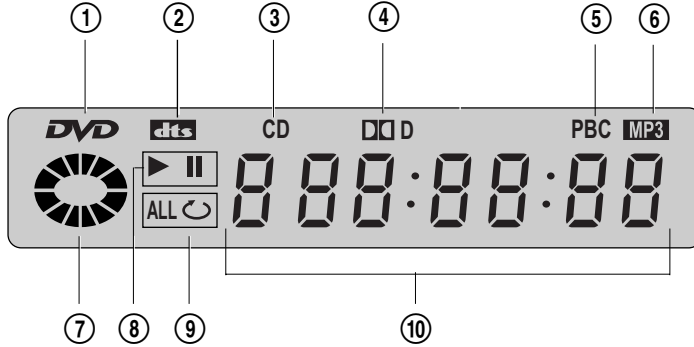

- ① **Recognized DISC TYPE indicator**
Illuminates the current operation mode.
- ② **DVD AUDIO STREAM indicator**
Indicates the audio type of the disc under play is DTS
- ③ **Recognized DISC TYPE indicator**
CD.
- ④ **DVD AUDIO STREAM indicator**
Indicates the audio type of the disc under play is DOLBY DIGITAL.
- ⑤ **PBC indicator**
This indicator is lit up in selecting PBC ON while this indicator disappears in selecting PBC OFF.
- ⑥ **Recognized DISC TYPE indicator**
Illuminates when MP3 disc is played.
- ⑦ **DISC LOAD/PLAY indicator**
This indicator is lit up after recognizing disc.
- ⑧ **PLAY/ PAUSE indicator**

- ⑨ **REPEAT MODE indicator**
□ : In case you want to repeat and play a chapter or track.
ALL □ : In case you want to repeat and play a title or disc.

- ⑩ **NUMBER/ CHARACTER indicator**
Title, chapter number, and time are displayed in loading DVD disc while track number and time are displayed in loading CD/CDMA/MP3/something disc.
- | | |
|----------------|--------------------------|
| <i>OPEN</i> | Tray is opened |
| <i>CLOSE</i> | Tray is closed |
| <i>LOAD</i> | Disc is loaded |
| <i>NO disc</i> | There is no disc in tray |
| <i>ERROR</i> | Disc has some error |

PREPARATIONS BEFORE OPERATION

NAMES AND LAYOUT OF REMOTE CONTROLS

* In case of setting the mode by using SETUP menu (for example, AUDIO select in PREFERENCE SETUP), the setting is kept though you switch the unit off and turn it on.

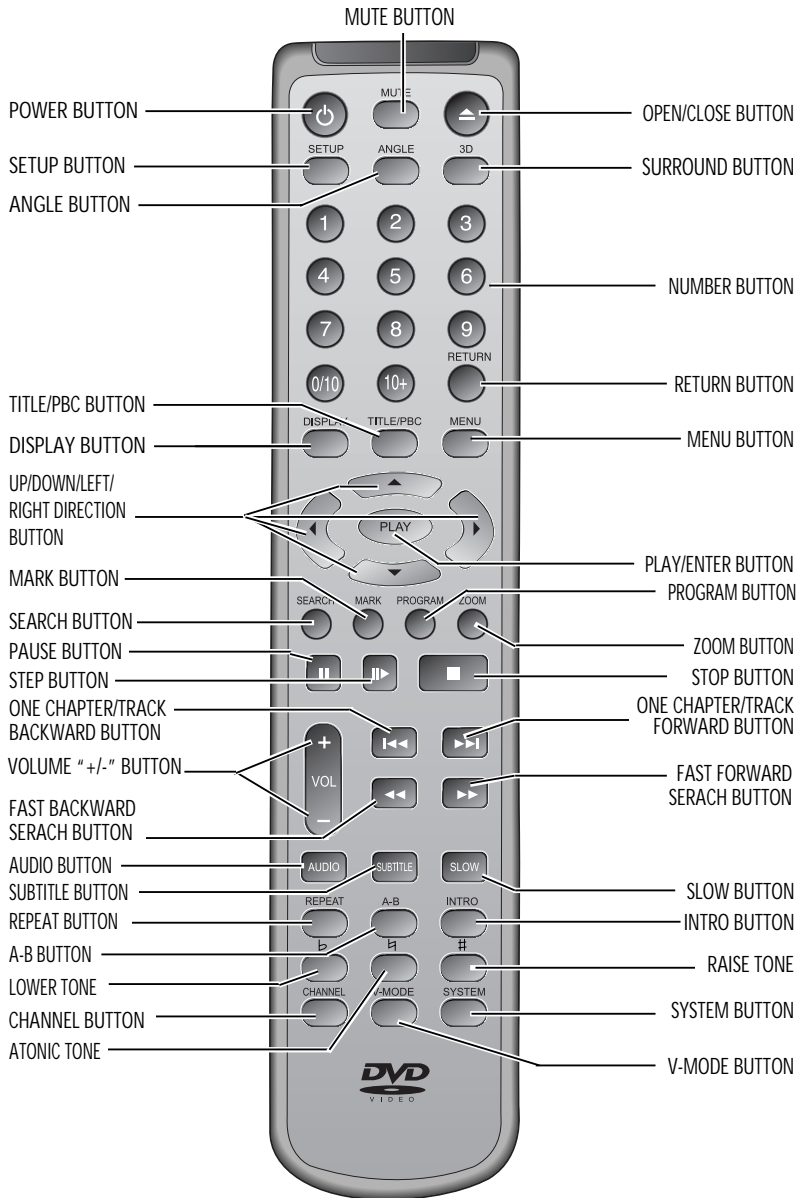

CONNECTIONS

Turn off all equipment before operation.

The unit has many kinds of output modes like A/V output, S-VIDEO output and digital signal output (COAXIAL, OPTICAL). You may select as you need.

CONNECTED TO A TV AND AN ORDINARY AMPLIFIER

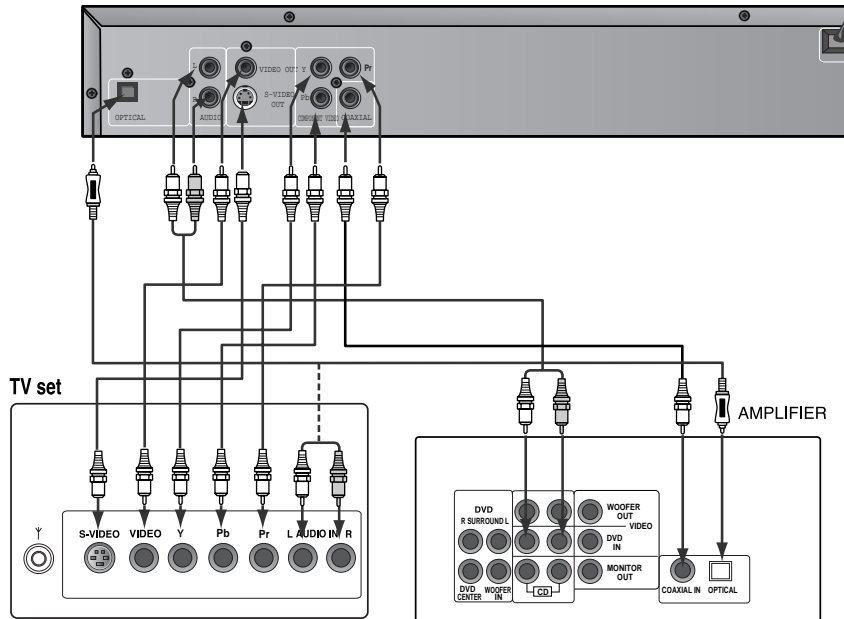

Manufactured under license from Dolby Laboratories. "Dolby" and the double-D symbol are trademarks of Dolby Laboratories. Confidential Unpublished works.

©1992-1997 Dolby Laboratories, Inc. All rights reserved.

"DTS" and "DTS Digital Out" are trademarks of Digital Theater Systems, Inc.

BASIC OPERATIONS

PLAY DISCS

- 1** Push "POWER" button on the TV and audio system, Push "TV/VIDEO" button on the TV, select VIDEO mode (TV).

Select S-Video mode if using an S-VIDEO connection.

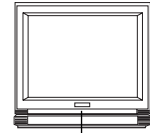

TV/VIDEO

- 2** Select the right audio input on the amplifier.
- Each amplifier is different from another, please refer to the manual of the amplifier. (e.g., connect the audio output of the DVD player to the DVD audio input of an amplifier.)

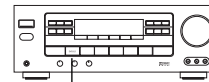

DVD/LD

 **Note:**
The Step2 can be cancelled if you do not connect it to the amplifier.

- 3** Push "STAND BY/ON" button on the front panel or "⏻" button on the remote control to turn the unit on.

- 4** Push "OPEN/CLOSE ▲" button to open the disc tray and insert the disc with its label look upward. Push "OPEN/CLOSE ▲" button again to close the disc tray. The unit begins to read the disc. The TV screen shows the DVD menu and title menu.

- In the case of DVD, DVD menus and titles are displayed on TV screen.
- In the case of something disc, the menus are displayed on TV screen and it is converted into PBC (Play Back Control) mode.
- In the case of CD, the disc plays in order of its track number.

- 5** Stop playback.
Press ■.

- 6** Press ▲ to remove the disc.

BASIC OPERATIONS

SYSTEM SETTING

According to the system of the TV to be connected, set the system of the unit to make it match the TV.

Push SYSTEM button on the remote control, then choose TV TYPE.

- If the system of the TV is PAL, push "SYSTEM" once.
- If the TV is multi-system, push "SYSTEM" twice.
- If the system of the TV is NTSC, push "SYSTEM" three times.

SYSTEM



V-MODE (Only when the player has component jack)

- In case of connecting the component, press the V-MODE on the remote control to select YUV (Y, Pb, Pr).
- When you connect the Composite or S-VIDEO and picture is not displayed, press the V-MODE on the remote control to check if DVD player position in the video mode.

V-MODE



DISPLAY

Each time you press "DISPLAY" button when playing a disc, the TV screen shows the information as :

DVD

- TITLE ELAPSED → TITLE REMAIN → CHAPTER ELAPSED
→ CHAPTER REMAIN → DISPLAY OFF

T: ** / ** C: ** / ** **: **: **

CD

- SINGLE ELAPSED → SINGLE REMAIN → TOTAL ELAPSED → TOTAL REMAIN

MP3

- Folder

Something disc

- SINGLE ELAPSED → SINGLE REMAIN → DISPLAY OFF

T: ** / ** **: **: **

DISPLAY

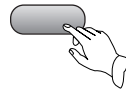

BASIC OPERATIONS

FAST PLAY

When playing disc, you may play it forward fast or reverse it fast to find what you need.

Note:
Push **PLAY** to play normally when playing fast.

1 Push **▶▶** to play forward fast. Each time you push the button, the speed of picture changes like the right sides.

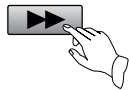

- ① **▶▶** FF X2
- ② **▶▶** FF X4
- ③ **▶▶** FF X8
- ④ **▶▶** FF X16
- ⑤ **▶▶** FF X32 (DVD only)
- ⑥ **▶▶** PLAY

Note:
The marked **FAST PLAY** speed on owner's manual and real fast play speed can be different depending on which disc you play.

2 Push **◀◀** to reverse the disc fast. Each time you push the button, the speed of picture changes like the right sides.

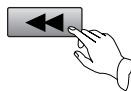

- ① **◀◀** FR X2
- ② **◀◀** FR X4
- ③ **◀◀** FR X8
- ④ **◀◀** FR X16
- ⑤ **◀◀** FR X32 (DVD only)
- ⑥ **◀◀** PLAY

SLOW PLAY

Enjoy slow motions by the following steps.

Note:
Push **PLAY** to play normally.

Push "SLOW" button to play slowly.

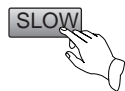

• something disc

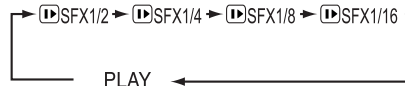

• DVD

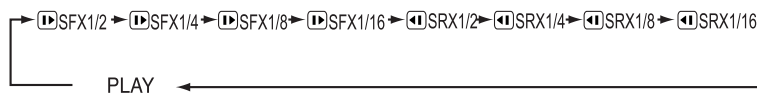

Note:
Push **PLAY** to play normally.

STEP/ PAUSE

Push **PAUSE** **||** on the remote control to make the playback pause.

Pushing **STEP** **▶▶** again moves the picture forward frame by frame.

BASIC OPERATIONS

SELECT AUDIO LANGUAGE

You can choose the language according to your choice when playing multi-language DVD.

Press "AUDIO" button, select different languages.



Note:

1. Different disc has different languages
2. You can push "AUDIO" button to choose the language you want when you play multi-language DVD discs.

*Attention:

Please select the AUDIO language in SETUP menu to keep the setting!!!

SELECT CHANNELS (CD, MP3)

You may select the right channel or left channel or stereo from a multi-channel.

Push "CHANNEL" button, the screen show alternately and select the desired audio channel:

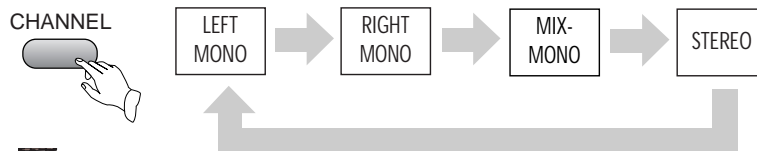

Note:

You can use channel function when you play the disc, you can choose mono audio output (left or right channel), stereo or mix-mono

SELECTING 3D AUDIO

This function outputs 3D effects on the stereo audio analog output where 3D effects are broken down into 7 surround modes.

- 1 Press [3D] button.
Every time the user presses [3D] button, CONCERT, LIVING ROOM, HALL, BATHROOM, CAVE, ARENA and CHURCH appear one by one.

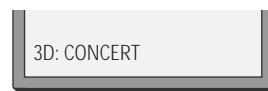

- 2 Select the desired 3D sound mode.

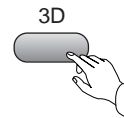

PLAYING A DESIRED SCENE

■ TO SKIP SCENES IN A DISC

- 1 Push **▶▶** to move to next chapter (or track).
The current chapter (or track) moves to the next chapter (or track).
- 2 Push **◀◀** to move to previous chapter (or track).
The current chapter (or track) moves to the previous chapter (or track) or first scene of current chapter (or track).

■ DIRECTLY MOVING TO A DESIRED TITLE (DVD)

Some movie discs may contain multiple titles. If the disc has a movie title menu recorded on it, the [TITLE/PBC] button can be used to select the movie title. Details of operation may differ depending on the disc used.

- 1 Push the [TITLE/PBC] or [MENU] button.

A list of the titles on the disc is displayed.

For the case of something disc, menu screen will appear only when the disc has PBC function and PBC ON is activated.



* In case of PBC play, press RETURN to return to the sub-menu, press it again to return to the home menu.

- 2 Push the [PLAY] button after pressing the [◀▶▲▼] button to select the desired title.

The selected title now starts playing.

 Note:
You can select the desired title directly by using number button.

PLAYING A DESIRED SCENE

PLAYING A DISC CONTAINING MP3 FILES

- 1 When a MP3 disc is loaded, MP3 menu screen is displayed automatically depending on MP3 disc's folder structure.
- 2 Use the direction button to select the folder you want to play, by pressing [PLAY] button. This button allows you to see the file lists under the folder.
- 3 Use the direction button and select a MP3 title using the PLAY button then play will start automatically. When you know the title number, enter the MP3 title number using the numeric buttons on the remote control and then press [PLAY] button.
- 4 Press **▶▶** on the remote control to choose next title (next files in play mode). Press **◀◀** for previous title (previous files in play mode).
When you know the title number, enter MP3 title number using the numeric buttons on the remote control and then press [PLAY] button.

REPEAT PLAY

When play DVD disc, this function can be used to repeatedly play a title, chapter or disc.

Push "REPEAT" button, the screen shows orderly.

REPEAT

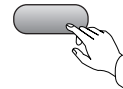

Note:
Push REPEAT to cancel the repeat function.

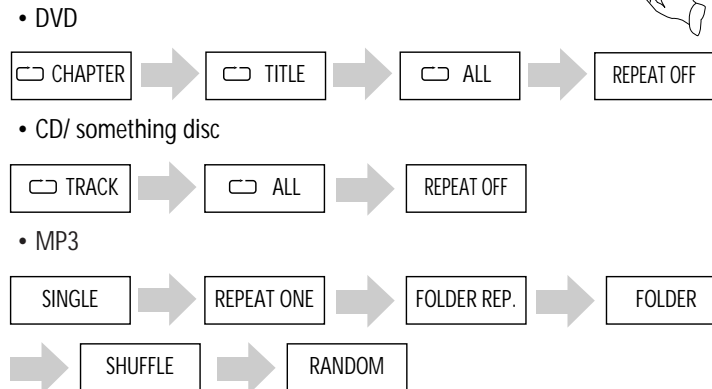

PLAYING A DESIRED SCENE

REPEATING A DEFINED PERIOD FROM A TO B

You may press A-B to enjoy some parts repeatedly when playing a disc.

1. Press "A-B" to set a starting point A.
2. Press "A-B" twice to an end point B.
Afterwards, the unit plays from A to B.
3. Press "A-B" three times to remove A-B repeat.

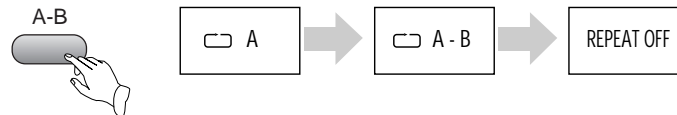

SELECT A SUBTITLE LANGUAGE

When play a multi-subtitle DVD, you may select one subtitle to show it on the screen.

 Note:

1. For some discs, subtitles cannot be removed.
2. Subtitle function is only available for some discs with subtitle recorders.

- 1 Keep pressing [SUBTITLE] button till the user's preferred language appears.

If a DVD disc includes subtitle information, every time the user presses [SUBTITLE] button, ENGLISH, FRENCH, SPANISH and others appear one by one.

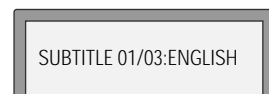

- 2 Remove the subtitle.

Press SUBTITLE until the screen shows "SUBTITLE OFF".

PLAYING A DESIRED SCENE

SEARCHING

SEARCHING DVD WITH A TITLE/CHAPTER NUMBER OR A TIME

- You may directly enter a title or chapter number to search fast on a disc. The unit plays from the point.

1 If you want to search with a chapter or a title number, press [SEARCH] button.

It shows the current disc mode; TITLE, CHAPTER, AUDIO, SUBTITLE, ANGLE, REPEAT, TIME Disp..

Select the TITLE or CHAPTER and enter the new chapter or title number to be searched using the [PLAY], [NUMBER] and [◀▶▲▼] buttons.

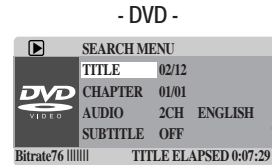

2 In completing entering, please press [SEARCH] button. PLAY starts from the selected position.

SEARCHING CD AND SOMETHING DISC WITH A TIME OR TRACK TIME

1 You may directly enter a disc or track time to search fast on a disc. The unit plays from the point.

- If you want to search with a track number, press [SEARCH] button.

It shows the current disc mode; TRACK, DISC TIME, TRACK TIME, REPEAT, TIME Disp..

Select the TRACK and enter the new track number to be searched using the [PLAY], [NUMBER] and [◀▶▲▼] buttons.

In completing entering, please press [SEARCH] button. PLAY starts from the selected position.



- If you want to search with a disc time, press [SEARCH] button.

Select the DISC TIME and enter the new time to be searched using the [PLAY], [NUMBER] and [◀▶▲▼] buttons.

2 If you want to search with a track time of CD, press [SEARCH] button.

Select the TRACK TIME and enter the new time to be searched using the [NUMBER] buttons.



PLAY DISCS IN VERIOUS WAYS

SELECT ANGLE

 **Note:**
Multi Angle function is limited to a DVD disc supporting multi angle information.

Some discs have images with different screen angles, you may select among them. For example, when you watch a running train, you may select to watch it from the front, the left window or the right window without stopping it.

Keep pressing [ANGLE] button till the preferred angle appears.

-  2/4 (select ANGLE2)
-  3/4 (select ANGLE3)
-  4/4 (select ANGLE4)

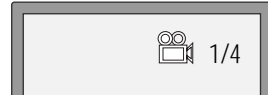

ANGLE



ZOOM PLAY

This function can be used to enjoy a motion or motionless picture.

- 1** Push "ZOOM" button when playing, the screen shows orderly:

ZOOM

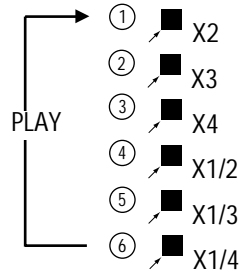

- 2** Push "UP/DOWN/LEFT/RIGHT [◀▶▲▼] button to move the enlarged picture.

BOOK MARK

 **Note:**
If you erase a book mark function, push "RETURN" button.

- 1** Push MARK button, the screen will show the following frame:

- 2** Moving direction button to select the saving position on the screen. Push PLAY button to save the time tag.

- 3** Push MARK button when you need book mark function, then choose the item you want to resume playing, then push PLAY button to continue playing from the saving point.

	02			05	
	08				

PLAY DISCS IN VERIOUS WAYS

PROGRAM PLAY (DVD)

You may program the title and chapter on a disc and play them in the programmed order.

1 Push "PROGRAM" button, the screen shows:

PROGRAM

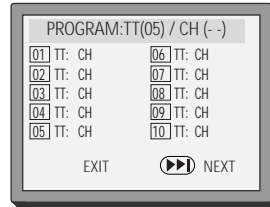

2 Input the sequence number you want to program playing.

3 After the programming is finished, move cursor to "START" by direction button and push "PLAY" button to start playing.

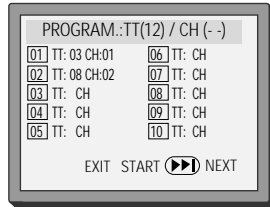

4 Push "STOP" button two times to remove program play.

* If you want to remove any program no, put the cursor in the position of the program number, push "RETURN" button.

Note:

- First one is title, second one is chapter.
- If the disc has only one title, TT will not be displayed.

PROGRAM PLAY (CD)

You may program the track on a disc and play them in the programmed order. (For MP3 play, refer to the page 28)

1 Push "PROGRAM" button, the screen shows:

2 Push direction button, input the sequence number you want to program playing.

After the programming is finished, push direction button to select "START", Push "PLAY" button to start playing.

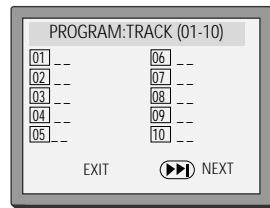

PLAY DISCS IN VARIOUS WAYS

DIGEST PLAY (DVD)

- 1 Push "INTRO" button when the unit is playing disc, the screen shows :
- 2 Push direction button to select the digest type. And push "PLAY" button.

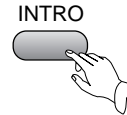
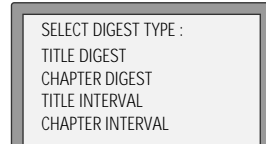

Note:

- **TITLE DIGEST**
The player will play 5 seconds each title. After moving the cursor in the position "--", push NUMBER button to select the title and push PLAY button. Then the player will begin to play from the title you selected. Or put the cursor in the position of desired picture and push PLAY button.
- **CHAPTER DIGEST**
The player will display the beginning picture of each chapter in current selected title.
- **TITLE INTERVAL**
Scan the story in the disc from 00:00:00 on, the unit will play the disc every other 10 minutes.
- **CHAPTER INTERVAL**
Scan the story in the current title from 00:00:00 on, the unit will play the disc every other 10 minutes.

DIGEST PLAY (something disc)

- 1 Push "INTRO" button when the unit is playing disc, the screen shows :
- 2 Push direction button to select the digest type. And push "PLAY" button.

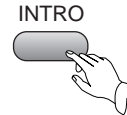
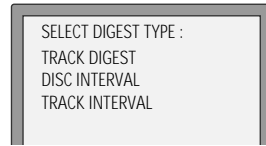

Note:

- **TRACK DIGEST**
The player will play 5 seconds each track. Push NUMBER button to select the track, then push PLAY button, the player will begin to play from the track you selected.
- **DISC INTERVAL**
Scan the story in the disc from 00:00:00 on, the unit will play the disc every other 10 minutes.

DIGEST PLAY (CD)

- 1 Push "INTRO" button when the unit is playing disc, the screen shows :
- 2 The player will play 5 seconds each track.

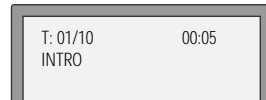

PLAY DISCS IN VERIOUS WAYS

- PLAY MP3 OR PIC-CD DISC
- USE NUMBER BUTTONS TO SELECT TRACKS (MP3 OR PIC-CD)

1 The screen will display as right after the disc is loaded

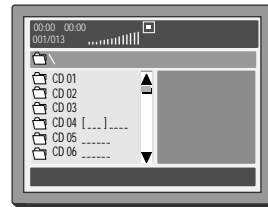

2 Each time you press PROGRAM button, FOLDER and FILE LIST appear one by one.

At this time you can select the item in the list.

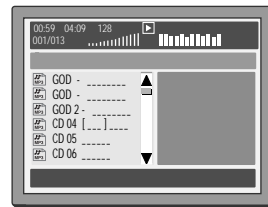

3 You can select the file you want using direction buttons.

4 Press PLAY button after selecting the file you want.
The file will be played back.

PLAY DISCS IN VERIOUS WAYS**■ SELECT PLAYING MODE (MP3 OR PIC-CD)**

Push "REPEAT" button, you can select "SINGLE", "REPEAT ONE", "FOLDER REPEAT", "FOLDER", "SHUFFLE" and "RANDOM".

- Single mode: the player will stop after finished playing the current item
- Repeat one mode: repeat the current item
- Repeat folder mode: repeat the items in the current directory
- Shuffle mode: play items by random
- Folder mode: the player will stop after finished playing the whole directory

■ PLAY PIC-CD BY ZOOM OR ROTATING OPERATING (PIC-CD)

The screen will show "ZOOM 100% " when you push ZOOM button under playing status, the current picture can be zoomed by push ►► or ◀◀ button, and the screen will also show the zoom ratio of the picture (ZOOM 100%, ZOOM 125%, ZOOM 150%, ZOOM 200%, ZOOM 75%, ZOOM 50%). The picture will restore to the normal status if you push PLAY button under the ZOOM status.

FUNCTION SETTING

■ MENU SETTING

According to the recorded information and external equipment, set the following functions for DVD to obtain the best playing status. Push "SETUP" button to set the main menu.

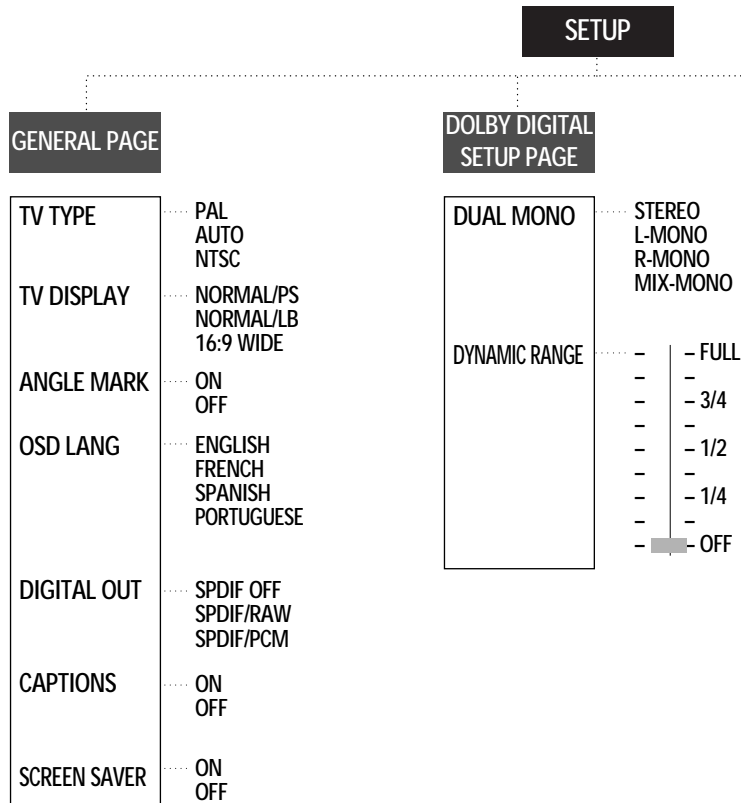

FUNCTION SETTING

BASIC NAVIGATION

To navigation through the setting on the screen, use the direction buttons to scroll through the list of settings and use "PLAY" button to select the high lighted function.

SETUP MENU

Press the SETUP button to enter the On Screen Display and to exit at any time. In each of the menus, selecting MAIN PAGE (SETUP menu) will immediately return you to the initial screen.

PREFERENCES PAGE	
AUDIO	ENGLISH FRENCH SPANISH CHINESE JAPANESE KOREAN RUSSIAN THAI
SUBTITLE	ENGLISH FRENCH SPANISH CHINESE JAPANESE KOREAN RUSSIAN THAI
DISC MENU	ENGLISH FRENCH SPANISH CHINESE JAPANESE KOREAN RUSSIAN THAI
PARENTAL	1 KID SAFE 2 G 3 PG 4 PG-13 5 PG-R 6 R 7 NC-17 8 ADULT NO PARENTAL
PASSWORD	CHANGE
DEFAULTS	RESET

FUNCTION SETTING

■ GENERAL SETUP

■ TV TYPE

You may select according to the colour system of the TV to be connected.

- Select "PAL" for a PAL TV.
- Select "AUTO" for a multi-system TV.
- Select "NTSC" for a NTSC TV.

■ TV DISPLAY

1 NORMAL/PS

This is selected when the unit is connected with a normal TV. Wide-screen images are shown on the screen, but with some parts cut automatically.



2 NORMAL/LB

This is selected when the unit is connected with a normal TV. Wide-screen images are shown on screen, with black belts on the top and bottom.

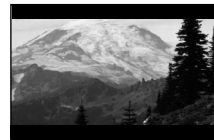

3 16:9 WIDE

This is selected when the unit is connected with a wide-screen TV.



■ ANGLE MARK

This only works when there is an angle mark on the disc.

- Select "ON", the screen shows the mark when playing a DVD.
- Select "OFF", the mark is not shown.



Note:

"OSD" means
"On Screen
Display".

■ OSD LANGUAGE

When select a language, the screen show this language.
For example, if you select ENGLISH, the OSD is in English.

■ AUDIO OUTPUT

• SPDIF OFF

No signal is output from the coaxial, optical port.

• SPDIF/RAW

Select this when the DVD player is connected with a power amplifier through optical or coaxial port. Please refer to the page 16. when a Dolby Digital DVD, DTS DVD or MPEG DVD is played, select this, the coaxial or optical port will output in the corresponding digital format (source code). The power amplifier to be connected must have Dolby Digital, DTS and MPEG DVD is played, the optical or coaxial port will output in PCM 2-channel format.

• SPDIF/PCM

Select this when the DVD player is connected with a TV or a power amplifier through audio cord.

■ CAPTIONS

The hidden subtitle is shown or turn off.

■ SCREEN SAVER

Start the screen saver, the screen saver image appears when the unit stops or the image is motionless for a few minutes. This saver can keep the screen from being damaged.

FUNCTION SETTING

■ DOLBY DIGITAL SETUP

■ DUAL MONO

This is the output mode of the L and R signals of the set audio output. If it is set to "MIX MONO", the function only works when the DVD being played is 2.0-channel.

- **STEREO**
Choose this option, the audio output should be dummy stereo signal.
- **L-MONO**
- **R-MONO**
- **MIX-MONO**

■ DYNAMIC RANGE

Set "Off" to view a program in the dynamic range as recorded in disc. If you hear loud sound softer and soft sound louder, set "Full".

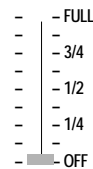

■ PREFERENCE SETUP

■ AUDIO

- **Selecting an audio language.**

Set it as the preferred audio language. In case the audio language is set and recorded in the DISC, it is automatically played in the set language in every playing. For example, English is set and recorded as audio language in the DISC, it is played in English.

■ SUBTITLE

- **Selecting Subtitle language.**

Please set it as the preferred language. In case the subtitle language is set and recorded in the DISC, it is automatically played in the set language in every playing. For example, English is set and recorded as subtitle language in the DISC, it is played in English.

■ DISC MENU

- **Selecting Disc Menu language.**

Please set it as the preferred DISC MENU language. In case the DISC MENU language is set and recorded in the DISC, it is automatically played in the set language in every playing. For example, English is set and recorded as a DISC MENU language in the DISC, it is played in English.

■ PARENTAL

The content of a disc with lock function is evaluated by grades. You can select an age grade as your need.



Note:

The password is set by yourself.

Example: Select "KID SAF", the scenes of violence inadvisable to children are not played.

For adults, the screen suggests you enter the code after pushing "PLAY" button, you can watch if the code is right.

■ PASSWORD



Note:

The password is 3308 when the unit is turned on initially or you forget the password.

Select "PASSWORD" in PREFERENCE SETUP menu to setup password, input a password.

Enter a password according to the screen.

OLD PASSWORD

NEW PASSWORD

CONFIRM PASSWORD

OK

■ DEFAULT>> RESET

Each function setting returns to the factory initial status if you select this.

OTHERS

■ TON CONTROL

You may change the pitch to adapt to your voice

- Push **#** to raise the pitch.

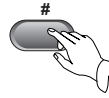

Each time you push the button, the pitch is raised by one step. It can be raised by 7 steps at the most.

- Push **b** to lower the pitch.

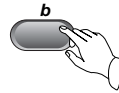

Each time you push the button, the pitch is lowered by one step. It can be raised by 7 steps at the most.

- Retune to the preliminary atonic-tone.

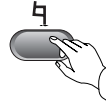

■ TROUBLESHOOTING

If you experience the following problems while using the unit, this troubleshooting guide can help you.

- **NO SOUND**
 - Check if the unit is connected securely.
 - Make sure you operate the TV or amplifier correctly.
- **NO IMAGE , IMAGE ROLLS AND NO COLOR**
 - Check if the unit is connected securely.
 - Make sure you operate the TV correctly.
 - Make sure you set the color system correctly.
- **BAD SOUND QUALITY**
 - Make sure the audio output mode is set correctly.
 - Make sure the audio connection between the unit and amplifier is right.
- **DISC CAN NOT BE PLAYED**
 - There is no disc in the unit.
 - Insert the disc on the disc tray properly with the label side up.
 - Clean the disc.
 - Moisture has condensed in the unit.
Remove the disc and leave the unit on for about one hour.
- **NO PHONE SOUND**
 - Switch on the microphone.
 - Turn the MIC LEVEL away knob clockwise.
- **SCREAMING**
 - Keep the phone far away from the speaker
 - Turn down the volume
 - Turn down the volume of phone and echo.
- **REMOTE CONTROL DOES NOT WORK**
 - Remove barriers between the remote control and the unit.
 - Replace the batteries with new ones.
 - Point the remote control at the remote control sensor of the unit.
- **ATTENTION: KEEPING THE STATUS OF STOP MORE THAN 5 MINUTES ENTERS SCREEN SAVE MODE. WHEN THE SCREEN SAVE MODE IS KEPT MORE THAN AN HOUR, THE SET ENTERS STAND-BY MODE.**

OTHERS

TECHNICAL SPECIFICATIONS

Laser		wavelength 650nm
Video		PAL/AUTO/NTSC
Frequency response		20Hz ~ 20KHz (± 1 dB)
Signal/noise ratio		≥ 90 dB
Channel separation		≥ 85 dB (1KHz)
Dynamic range		≥ 80 dB (1KHz)
Output Audio	Analog	output level : $2.0 + 0/-0.2$ Vrms (Load impedance : $10K\Omega$)
	Digital	output level : 0.5 ± 0.1 Vp-p (Load impedance : 75Ω)
Output Video	Composite	output level : 1.0 ± 0.1 Vp-p (Load impedance : 75Ω , imbalance, negative polarity)
	S-video	output level : brightness (Luma) 1.0 ± 0.1 Vp-p chromaticity (Color) $0.286 \pm 20\%$ (Load impedance : 75Ω)
	Component	Y: 1 Vp-p, Pb/Pr: 0.7 Vp-p (Load impedance : 75Ω)
Power supply		AC100 ~ 240V, 50/60Hz
Power consumption		< 14W
Dimensions (W x H x D)		430 x 48 x 286 mm
Weight		About 3.8Kgs

Notes : Design and specifications in this owner's manual are subjected to change without prior notice to improve quality and function.

Free Manuals Download Website

<http://myh66.com>

<http://usermanuals.us>

<http://www.somanuals.com>

<http://www.4manuals.cc>

<http://www.manual-lib.com>

<http://www.404manual.com>

<http://www.luxmanual.com>

<http://aubethermostatmanual.com>

Golf course search by state

<http://golfingnear.com>

Email search by domain

<http://emailbydomain.com>

Auto manuals search

<http://auto.somanuals.com>

TV manuals search

<http://tv.somanuals.com>