

DAEWOO ELECTRONICS 

# OWNER'S MANUAL

DVG-9100N/ DVG-9200N



# DVD PLAYER



# TABLE OF CONTENTS

<b>IMPORTANT SAFETY PRECAUTIONS</b> ....	<b>2</b>	<b>PLAY DISCS IN VARIOUS WAYS</b> .....	<b>23</b>
<b>FEATURES</b> .....	<b>5</b>	Select Angle.....	23
<b>ABOUT DISC</b> .....	<b>6</b>	Zoom Play.....	23
<b>BEFORE OPERATION</b> .....	<b>8</b>	Mark.....	23
<b>PREPARATIONS BEFORE OPERATION.</b>	<b>10</b>	Program Play (DVD).....	24
Front Panel .....	10	Program Play (CD) .....	24
Rear Panel .....	11	Digest Play (DVD) .....	25
VFD.....	12	Digest Play (something disc).....	25
Names and Layout of Remote Controls .....	13	Digest Play (CD).....	25
		Play MP3 or PIC-CD Disc .....	26
<b>CONNECTIONS</b> .....	<b>14</b>	<b>FUNCTION SETTING</b> .....	<b>28</b>
<b>BASIC OPERATIONS</b> .....	<b>15</b>	Menu Setting.....	28
Play Discs .....	15	General Setup.....	30
System Setting.....	16	Dolby Digital Setup.....	32
V-Mode .....	16	Preference Setup .....	32
Display.....	16	<b>OTHERS</b> .....	<b>34</b>
Fast Play .....	17	Troubleshooting .....	34
Slow Play.....	17	Technical Specifications.....	35
Pause/ Step.....	17		
Select Audio Language .....	18		
Select Channels .....	18		
Selecting 3D Audio .....	18		
<b>PLAYING A DESIRED SCENE</b> .....	<b>19</b>		
To skip scenes in a disc.....	19		
Directly moving to a desired title (DVD) .....	19		
Playing a disc containing MP3 files .....	20		
Repeat Play .....	20		
Repeating a defined period from A to B (DVD) ..	21		
Select a Subtitle Language .....	21		
Searching.....	22		

# IMPORTANT SAFETY PRECAUTIONS

	<b>CAUTION</b> RISK OF ELECTRIC SHOCK DO NOT OPEN	
<p><b>CAUTION:</b> TO REDUCE THE RISK OF ELECTRIC SHOCK, DO NOT REMOVE COVER (OR BACK). NO USER-SERVICEABLE PARTS INSIDE. REFER SERVICING TO QUALIFIED SERVICE PERSONNEL.</p>		



The lightning flash with arrowhead symbol, within an equilateral triangle, is intended to alert the user to the presence of uninsulated "dangerous voltage" within the product's enclosure that may be of sufficient magnitude to constitute a risk of electric shock.



The exclamation point within an equilateral triangle is intended to alert the user to the presence of important operating and servicing instructions in the literature accompanying the appliance.

**WARNING :** TO REDUCE THE RISK OF FIRE OR ELECTRIC SHOCK, DO NOT EXPOSE THIS APPLIANCE TO RAIN OR MOISTURE.  
**CAUTION :** TO PREVENT ELECTRIC SHOCK, MATCH WIDE BLADE OF PLUG TO WIDE SLOT, FULLY INSERT.

**IMPORTANT FOR LASER PRODUCTS**

- LASER :** This Digital Video Disc Player employs a Laser System. To ensure proper use of this product please read this owner's manual carefully and retain for future reference. Should the unit require maintenance, contact an authorized service location - see service procedure.

Use of control adjustments or the performance of procedures other than those specified may result in hazardous radiation exposure.

To prevent direct exposure to the laser beam, do not try to open the enclosure. Visible laser radiation when open and interlocks defeated.

**DO NOT STARE INTO THE BEAM.**
- DANGER :** Visible laser radiation when open and interlock failed or defeated. Avoid direct exposure to beam.
- CAUTION :** Do not open the top cover. There are no user serviceable parts inside the Unit; leave all servicing to qualified service personnel.

**CLASS 1  
LASER PRODUCT**

**CAUTION:** Any changes or modification in construction of this device which are not expressly approved by the party responsible for compliance could void the user's authority to operate the equipment.

**ATTENTION:** KEEPING THE STATUS OF STOP MORE THAN 5 MINUTES ENTERS SCREEN SAVE MODE. WHEN THE SCREEN SAVE MODE IS KEPT MORE THAN AN HOUR, THE SET ENTERS STAND-BY MODE.

**MACROVISION**

This product incorporates copyright protection technology that is protected by U.S patents and other intellectual property rights. Use of this copyright protection technology must be authorized by Macrovision, and is intended for home and other limited viewing uses only unless otherwise authorized by Macrovision. Reverse engineering or disassembly is prohibited.

## IMPORTANT SAFETY PRECAUTIONS

This set has been designed and manufactured to assure personal safety. Improper use can result in electric shock or fire hazard. The safeguards incorporated in this unit will protect you if you observe the following procedures for installation, use and servicing. This unit is fully transistorized and does not contain any parts that can be repaired by the user.

### 1 READ INSTRUCTIONS

All the safety and operating instructions should be read before the unit is operated.

### 2 RETAIN INSTRUCTIONS

The safety and operating instructions should be retained for future reference.

### 3 HEED WARNINGS

All warnings on the unit and in the operating instructions should be adhered to.

### 4 FOLLOW INSTRUCTIONS

All operating and use instructions should be followed.

### 5 CLEANING

Unplug this unit from the wall outlet before cleaning. Do not use liquid cleaners or aerosol cleaners. Use a damp cloth for cleaning.

### 6 ATTACHMENTS

Do not use attachments unless recommended by the unit's manufacturer as they may cause hazards.

### 7 WATER AND MOISTURE

Do not use this unit near water- for example, near a bath tub, wash bowl, kitchen sink or laundry tub, in a wet basement, or near a swimming pool.

### 8 ACCESSORIES

Do not place this unit on an unstable cart, stand, tripod, bracket, or table. The unit may fall, causing serious injury to a child or adult as well as serious damage to the unit. Use this unit only with a cart, stand, tripod, bracket, or table recommended by the manufacturer.

### 8A

A unit and cart combination should be moved with care. Quick stops, excessive force, and uneven surfaces may cause the video product and cart combination to overturn.

### 9 VENTILATION

Slots and openings in the case are provided for

ventilation to ensure reliable operation of the unit and to protect it from overheating. These openings must not be blocked or covered. These openings must not be blocked by

placing the unit on a bed, sofa, rug, or other similar surface. This unit should never be placed near or over a radiator or heat radiator. This unit should not be placed in a built-in installation such as a bookcase or rack unless proper ventilation is provided or the manufacturer's instructions have been adhered to.

### 10 POWER SOURCES

This unit should be operated only from the type of power source indicated on the marking label. If you are not sure of the type of power supply to your home, consult your video dealer or local power company. For units intended to operate from battery power, or other sources, refer to the operating instructions.

### 11 GROUNDING OR POLARIZATION

This unit is equipped with a polarized alternating - current line plug (a plug having one blade wider than the other). This plug will fit into the power outlet only one way.

This is a safety feature. If you are unable to insert the plug fully into the outlet, try reversing the plug. If the plug still fails to fit, contact your electrician to replace your obsolete outlet. To prevent electric shock, do not use this polarized plug with an extension cord, receptacle, or other outlet unless the blades can be fully inserted without blade exposure. If you need an extension cord, use a polarized cord.

### 12 POWER-CORD PROTECTION

Power-supply cords should be routed so that they are not likely to be walked on or pinched by items placed upon or against them, paying particular attention to cords at plugs and the point where they exit from the unit.

### 13 LIGHTNING

For added protection for this unit during a lightning storm, or when it is left unattended and unused for long periods of time, unplug it from the wall outlet and disconnect the antenna or cable system.

**PORTABLE CART WARNING**  
(symbol provided by RETAC)



## IMPORTANT SAFETY PRECAUTIONS

This will prevent damage to the unit due to lightning and power line surges.

### 14 DISC TRAY

Keep your fingers well clear of the disc as it is closing. It may cause serious personal injury.

### 15 OVERLOADING

Do not overload wall outlets or extension cords as this can result in a risk of fire or electric shock.

### 16 OBJECT AND LIQUID ENTRY

Never push objects of any kind into this unit through openings as they may touch dangerous voltage points or "short-out" parts that could result in a fire or electric shock. Never spill liquid of any kind on the unit.

### 17 BURDEN

Do not place a heavy object on or step on the product. The object may fall, causing serious personal injury and serious damage to the product.

### 18 DISC

Do not use a cracked, deformed or repaired disc. These discs are easily broken and may cause serious personal injury and product malfunction.

### 19 SERVICING

Do not attempt to service this unit yourself as opening or removing covers may expose you to dangerous voltage or other hazards. Refer all servicing to qualified service personnel.

### 20 DAMAGE REQUIRING SERVICE

Unplug this unit from the wall outlet and refer servicing to qualified service personnel under the following conditions.

- A. When the power-supply cord or plug is damaged.
- B. If liquid has been spilled, or objects have fallen into the unit.
- C. If the unit has been exposed to rain or water.
- D. If the unit does not operate normally by following the operating instructions. Adjust only those controls that are covered by the operating instructions. Improper adjustment of other controls may result in damage and will often require extensive work by a qualified technician to restore the unit to its normal operation.
- E. If the product has been dropped or the cabinet has been damaged.

F. When the unit exhibits a distinct change in performance-this indicates a need for service.

### 21 REPLACEMENT PARTS

When replacement parts are required, have the service technician verify that the replacements he uses have the same safety characteristics as the original parts. Use of replacements specified by the unit manufacturer can prevent fire, electric shock, or other hazards.

### 22 SAFETY CHECK

Upon completion of any service or repairs to this unit, ask the service technician to perform safety checks recommended by the manufacturer to determine that the unit is in safe operating condition.

### 23 WALL OR CEILING MOUNTING

The product should be mounted to a wall or ceiling only as recommended by the manufacturer.

### 24 HEAT

The product should be situated away from heat sources such as radiators, heat registers, stoves, or other products (including amplifiers) that produce heat.



### FCC NOTICE :

This equipment has been tested and found to comply with the limits for a Class B digital device, pursuant to part 15 of the FCC Rule. These limits are designed to provide reasonable protection against harmful interference in a residential installation. This equipment generates, uses and can radiate radio frequency energy and if not installed and used in accordance with the instructions, may cause harmful interference to radio communications. However, there is no guarantee that interference will not occur in a particular installation. If this equipment does cause harmful interference to radio or television reception; which can be determined by turning the equipment off and on, the user is encouraged to try to correct the interference by one or more of the following measures:

- Reorientate or relocate the receiving antenna.
- Increase the separation between the equipment and receiver.
- Connect the equipment to an outlet on a circuit different from that to which the receiver is connected.
- Consult the dealer or an experience radio/TV technical for help.

## FEATURES

### ④ OUTSTANDING SOUND QUALITY

Dolby Digital  system developed by Dolby Laboratories and DTS  developed by DTS Inc., features high quality surround sound which can be played in DVD or CD disc at home, to reproduce high quality sound effects.

### ④ HIGH DEFINITION

The unit adopts MPEG2 coding format and brings the high horizontal resolution.

### ④ UNIQUE FUNCTIONS

Multi-angle and multi-language bring unique trick functions.  
Parent lock makes it easy to control the content of discs.

### ④ SCREEN

Ordinary screen and wide screen (16:9) are available.

### ④ COMPATIBILITY

The unit can play DVD-video discs, and is compatible with CD, CD-G, CD-R, CD-RW, PIC-CD, MP3 discs also can do DVD-R, DVD-RW, DVD+RW of video format.

### ④ ZOOM

It can enlarge pictures.

### ④ MULTI-FUNCTIONS

Fast forward, fast reverse, forward and reverse slow, frame play, repeat play and program play.

### ④ TIME SEARCH

It can search a specific part on a disc, especially good for watching fiction movies.

### ④ RESUME PLAY

It can memorize the position where the disc is stopped and resume playback.

### ④ VIDEO OUTPUT

Standard video, S-video, component (progressive, interlace) video output mode.

### ④ AUDIO OUTPUT

Analog audio output, coaxial and optical digital audio output, can be connected with the appropriate amplifier to enjoy high-quality sound effects.

# ABOUT DISC

## PRINCIPLES FOR WRITING

This manual mainly introduces how to use buttons on the remote control. You may operate the unit if the buttons on the unit have the same or similar names as or to those on the remote control.

## PLAYABLE DISCS

- DVD and Audio CD

Disc type	Playable	Restriction
DVD-video	Possible	Region number 1 or Region number All
CD	Possible	PCM or DTS digital out
CD-G	Possible	Audio/Graphic playback
CD-R	Possible	CD/ MP3
CD-RW	Possible	CD/ MP3
DVD-R	Possible	DVD video
DVD-RAM	impossible	
DVD-RW	Possible	DVD video
DVD+RW	Possible	DVD video
Picture CD/ JPEG	Possible	Total disc capacity: over 4M, Each file : under 1M
CD/ MP3	Possible	Windows format only

## STRUCTURE OF DVD

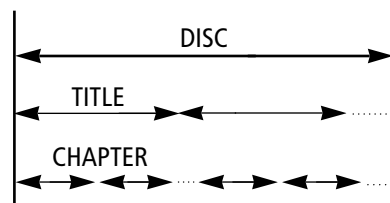

## STRUCTURE OF CD

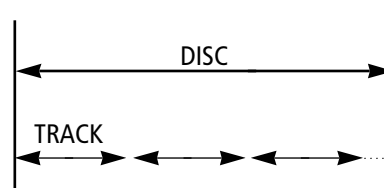

## TITLE

The images or music of a DVD are divided into some units, among which title is the biggest one.

When playing a DVD, the movie is the title.

When playing a CD, the combined tracks make up the title.

## CHAPTER

It is smaller than title among the units of a DVD. A title is made up of several chapters, and each chapter has a number for search. But some discs may not have numbered chapters.

**ABOUT DISC****TRACK**

In a CD, each track has a number to enable search functions.

**SCENE**

The menu pictures, motion and motionless pictures of a CD can be divided into some parts, these parts are scenes. Each scene has a number for search.

**REGION MANAGEMENT INFORMATION**

This unit is designed and manufactured to respond to the Region Management information that is recorded on a DVD disc. The region number of this player is "1". If the region number described on the DVD discs does not correspond to the Region number of this player, the player will not play this disc. This player will play DVD discs made for "ALL" regions. Therefore, this player will play DVD discs marked with labels containing the region number "1" or "ALL".



(Region 1)



(Region ALL)



## BEFORE OPERATION

### SECURITY

- Before operation, check if the voltage of the unit is in line with the local voltage.
- Hold the plug to disconnect it from the mains outlet. Do not pull the power cord.
- When the plug of the unit is connected to the mains outlet, the unit will be still connected to AC even if the power is turned off.
- Disconnect the plug as soon as liquid or objects enter the unit. The unit can not be used until being checked by experts.
- Do not open the cabinet as laser rays employed by the unit may damage eyes. Any servicing should be done by qualified service personnel.

### PLACEMENT

- Put the unit where ventilation is good enough to prevent overheating.
- Never put the unit in direct sunlight or near heat sources.
- Put the unit horizontally, never put any heavy object on the unit.
- To protect the pickup, do not put the unit where there is dust. If there is dust on the pickup, use a cleaning disc to clean it. Paying particular attention to the operating instructions of the cleaning disc.

### CONDENSATION

Moisture will appear on the pickup lens in the following cases:

- The unit is suddenly moved from a cold place to a warm place.
- The unit is put in a room with a heater, or in cold air from an air-conditioner.
- Using the unit in a humid place. In these cases, the unit can not work. Unload the disc and leave the unit on for about one hour to evaporate the moisture.

### CLEANING

- Use a soft cloth with a little neutral detergent to wipe the cabinet, panel and controls.

Never use abrasive paper, polishing powder, solvent like alcohol or gasoline.

### HANDLING DISC





- To keep the disc clean, do not touch the playsides of the disc.
- Do not attach paper or tape to the disc.
- Keep the disc away from direct sunlight or heat sources.
- Store the disc in a disc case after playback.

### CLEANING DISC

- Before playback, wipe the disc outward from the centre with clean cloth.
- Do not use any type of solvent such as thinner, benzine, commercially available cleaners or antistatic spray.

**BEFORE OPERATION****■ CHECK ACCESSORIES**

Check if you have all the accessories after the carton is opened.

Remote control	AAA batteries	Video/Audio cord	Owner's manual
			

**■ USE REMOTE CONTROL**

- 1 Open the battery compartment.
- 2 Insert two AAA batteries, make sure to match "+" and "-" of the batteries to the marks in the battery compartment.
- 3 Close the battery compartment.
- 4 Point the remote control at the remote sensor.

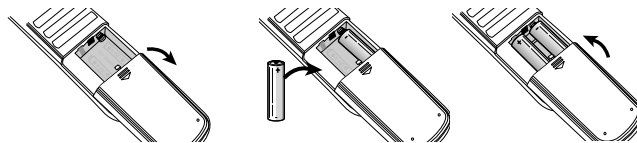
**Note:**

1. Batteries can last for about 6 months generally. Change the batteries of that does not work.
2. If the remote control is not used for a long time, remove the batteries to prevent battery leakage.

## PREPARATIONS BEFORE OPERATION

### FRONT PANEL

#### DVG-9100N

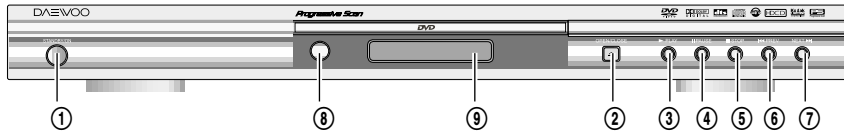

#### DVG-9200N



- ① **STANDBY/ON button**  
To switch the unit On or Off when connected to AC power outlet
- ② **OPEN/CLOSE button**  
To open or close the disc tray.
- ③ **PLAY button**  
To play the loaded disc. Press this button to go to the preferred item when the menu is displayed on the TV screen.
- ④ **PAUSE button**  
Used to view one frame at a time during play. Press PLAY button for normal play.
- ⑤ **STOP**
- ⑥ **PREV button**  
To skip back from the current chapter (for DVD) or track (for CD).
- ⑦ **NEXT button**  
To skip forward to the next chapter (for DVD) or track (for CD). If playing a Video CD with PBC, this button works as the NEXT button to move to the next play list.
- ⑧ **REMOTE SENSOR**  
Receives a light signal from the remote controller.
- ⑨ **DISPLAY**  
Displays operation status

## PREPARATIONS BEFORE OPERATION

### REAR PANEL

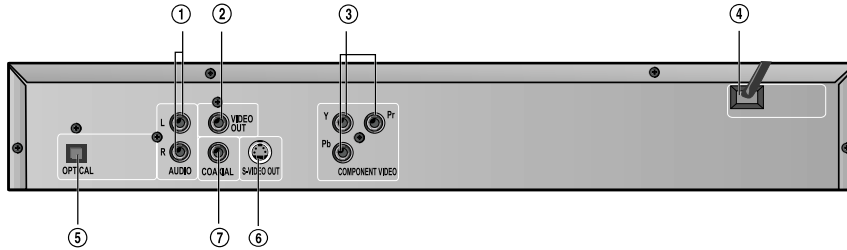

#### ① AUDIO OUT (L/R TRACK)

Two phono sockets for analogue 2 Channel audio in order to a TV or stereo amplifier.

#### ② VIDEO OUT

Connects composite video signal to input AV or PHONO sockets of TV or monitor to achieve high fidelity colour reproduction.

#### ③ COMPONENT (Y.Pb.Pr)

Connects to TV or monitor equipped with Component input . In order to achieve a sharper and cleaner picture than when connected via VIDEO OUT (composite video).

#### ④ POWER SUPPLY SOCKET WIRE

Creates POWER between wall outlet and the unit..

#### ⑤ DIGITAL AUDIO OPTICAL OUT

Connects digital audio under play mode into an AV amplifier or a receiver equipped with digital audio decoder for you to enjoy the theatre-quality sound in your home.

#### ⑥ S-VIDEO OUTPUT

Connects to TV or monitor equipped with S-VIDEO input. In order to achieve a sharper and cleaner picture than when connected via VIDEO OUT (composite video).



#### ⑦ DIGITAL AUDIO COAXIAL OUT

Connects digital audio under play mode into an AV amplifier or a receiver equipped with digital audio decoder for you to enjoy the theatre-quality sound in your home.

## PREPARATIONS BEFORE OPERATION

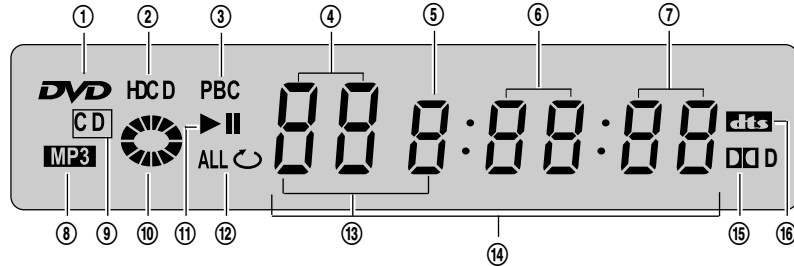
### VFD



- ① **Recognized DISC TYPE indicator**  
: DVD
- ② **Recognized DISC TYPE indicator**  
: HDCD
- ③ **PBC indicator**  
This indicator is lit up in selecting PBC ON while this indicator disappears in selecting PBC OFF.
- ④ **DVD/CD indicator**  
Indicates the chapter or track number.
- ⑤ **DVD/CD indicator**  
Indicates the hour.
- ⑥ **DVD/CD indicator**  
Indicates the minutes.
- ⑦ **DVD/CD indicator**  
Indicates the seconds.
- ⑧ **Recognized DISC TYPE indicator**  
: MP3
- ⑨ **Recognized DISC TYPE indicator**  
: CD.
- ⑩ **DISC LOAD/PLAY indicator**  
This indicator is lit up after recognizing the disc.
- ⑪ **PLAY/ PAUSE indicator**
- ⑫ **REPEAT MODE indicator**  
 : In case you want to repeat and play a chapter or track.  
ALL  : In case you want to repeat and play a title or disc.
- ⑬ **MP3 indicator**  
Indicates the track number when MP3 disc is played
- ⑭ **NUMBER/ CHARACTER indicator**  
Chapter, track number, and time are displayed in loading DVD/CD disc, while track number and time are displayed in loading MP3.  
*OPEN* : Tray is opened  
*CLOSE* : Tray is closed  
*LOAD* : Disc is loaded  
*NO DISC* : There is no disc in tray  
*ERROR* : Disc has some error
- ⑮ **DVD AUDIO STREAM indicator**  
**Indicates the audio type of the disc under play is DOLBY DIGITAL.**
- ⑯ **DVD AUDIO STREAM indicator**  
:dts

## PREPARATIONS BEFORE OPERATION

### NAMES AND LAYOUT OF REMOTE CONTROLS

\* After setting the mode by using SETUP menu (for example, AUDIO select in PREFERENCE SETUP), the setting is kept though you switch the unit off and turn it on.

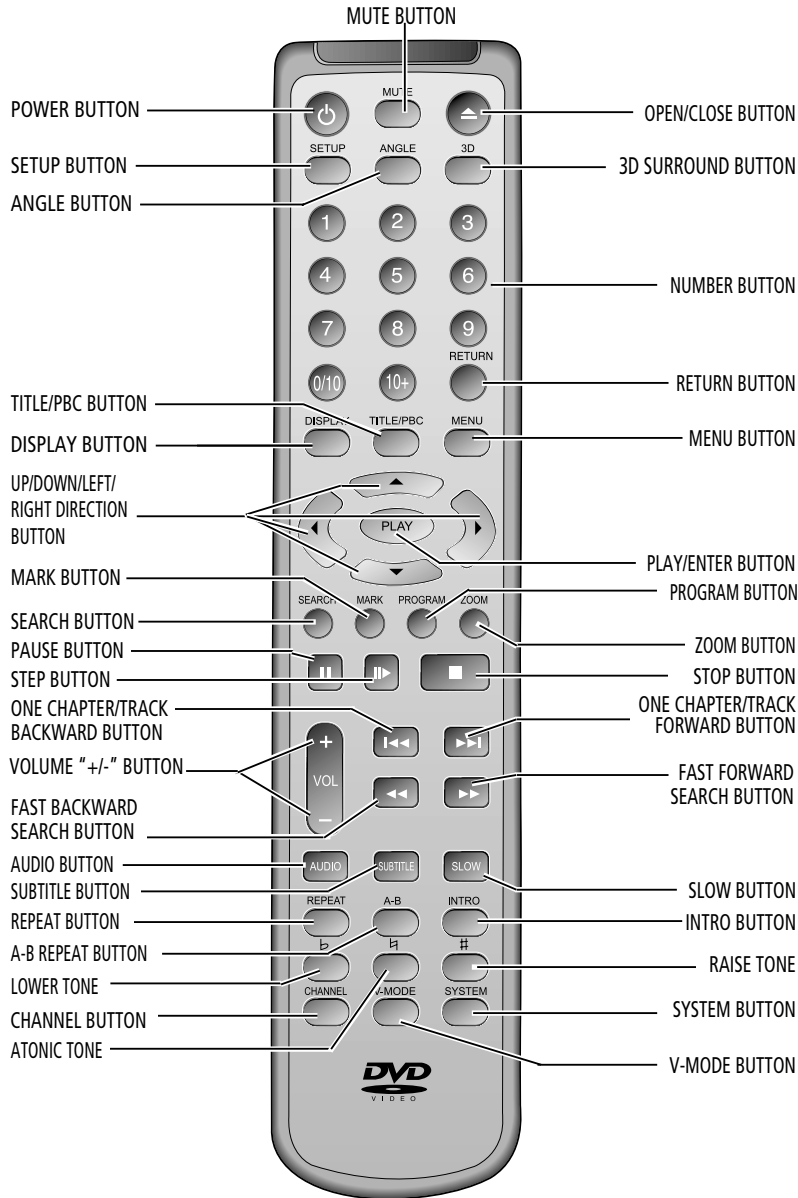

# CONNECTIONS

Turn off all equipment before operation.  
 The unit has many kinds of output modes like A/V output, S-VIDEO output and digital signal output (COAXIAL, OPTICAL). You may select as you need.

## CONNECTED TO A TV AND AN ORDINARY AMPLIFIER

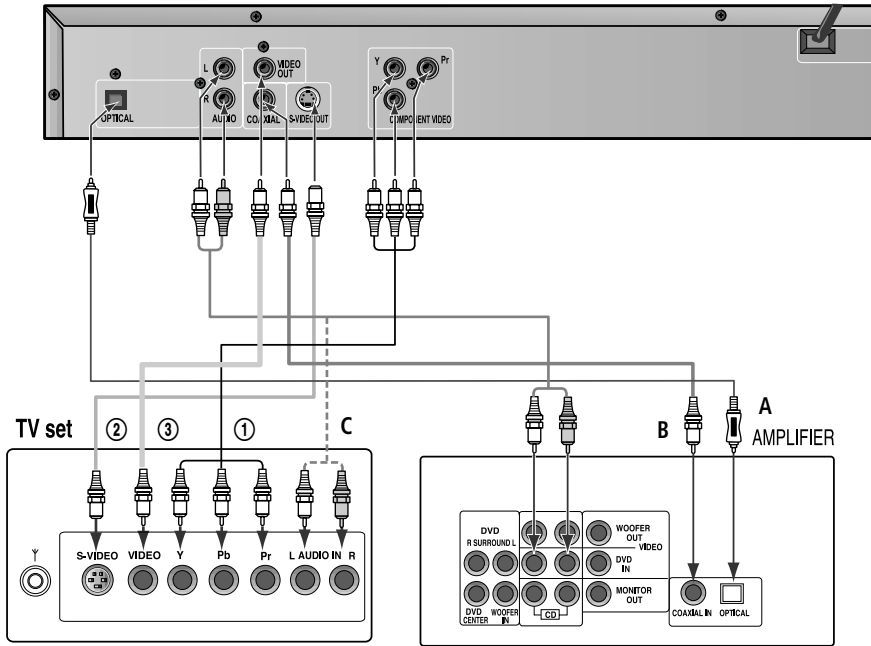

Connects either ①+A, ②+A, ③+A, ①+B, ②+B, ③+B, ①+C, ②+C or ③+C.

Manufactured under license from Dolby Laboratories. "Dolby" and the double-D symbol are trademarks of Dolby Laboratories. Confidential Unpublished works.  
 ©1992-1997 Dolby Laboratories, Inc. All rights reserved.  
 "DTS" and "DTS Digital Out" are trademarks of Digital Theater Systems, Inc.

# BASIC OPERATIONS

## PLAY DISCS

- 1 Push "POWER" button on the TV and audio system, Push "TV/VIDEO" button on the TV, select VIDEO mode (TV).

Select S-Video mode if using an S-VIDEO connection.



### Note:

*The Step2 can be cancelled if you do not connect it to the amplifier.*

- 2 Select the correct audio input on the amplifier.
  - Each amplifier is different from another, please refer to the manual for the amplifier. (e.g., connect the audio output of the DVD player to the DVD audio input of an amplifier.)

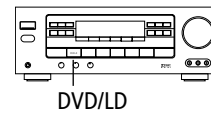

- 3 Push "STAND BY/ON" button on the front panel or "⏻" button on the remote control to turn the unit on.

- 4 Push "OPEN/CLOSE ▲" button to open the disc tray and insert the disc with its label upward. Push "OPEN/CLOSE ▲" button again to close the disc tray. The unit begins to read the disc. The TV screen shows the DVD menu and title menu.

- When playing a DVD, DVD menus and titles are displayed on TV screen.
- In the case of CD, the disc plays in order of its track number.

- 5 Stop playback.  
Press ■.

- 6 Press ▲ to remove the disc.



## BASIC OPERATIONS

### SYSTEM SETTING

According to the system of the TV to be connected, set the system of the unit to make it match the TV.

Push SYSTEM button on the remote control, then choose TV TYPE.

- Every time the user presses the [SYSTEM] button, the video output system changes as follows.



SYSTEM

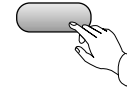

### V-MODE (WHEN SELECTING INTRLACE OR PROGRESSIVE OR S-VIDEO.)

- In case of connecting the component, press the V-MODE on the remote control to select INTRLACE OR PROGRESSIVE.



When you connect the Composite, picture is not displayed, press the V-MODE on the remote control to select Composite video.

V-MODE

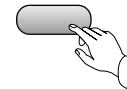

### DISPLAY

Each time you press the "DISPLAY" button when playing a disc, the TV screen shows the information as :

#### DVD

TITLE ELAPSED → TITLE REMAIN → CHAPTER ELAPSED →  
CHAPTER REMAIN → DISPLAY OFF

DISPLAY

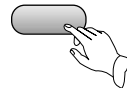

#### CD

SINGLE ELAPSED → SINGLE REMAIN → TOTAL ELAPSED → TOTAL REMAIN  
→ DISPLAY OFF

#### MP3

CHAPTER ELAPSED → CHAPTER REMAIN → DISPLAY OFF

## BASIC OPERATIONS

### FAST PLAY

When playing disc, you may play it forward fast or reverse it fast to find what you need.

**Note:**  
Push **PLAY** to play normally when playing fast.

**1** Push **▶▶** to play forward fast. Each time you push the button, the speed of picture changes like the right sides.

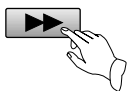

- ① **▶▶** FF X2
- ② **▶▶** FF X4
- ③ **▶▶** FF X8
- ④ **▶▶** FF X16
- ⑤ **▶▶** FF X32 (DVD only)
- ⑥ **PLAY**

**Note:**  
The marked **FAST PLAY** speed on owner's manual and real fast play speed can be different depending on which disc you play.

**2** Push **◀◀** to reverse the disc fast. Each time you push the button, the speed of picture changes like the right sides.

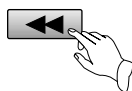

- ① **◀◀** FR X2
- ② **◀◀** FR X4
- ③ **◀◀** FR X8
- ④ **◀◀** FR X16
- ⑤ **◀◀** FR X32 (DVD only)
- ⑥ **PLAY**

### SLOW PLAY

**Note:**  
Push **PLAY** to play normally.

Enjoy slow motions by the following steps.

Push "**SLOW**" button to play slowly.

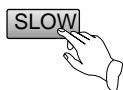

**Note:**  
Push **PLAY** to play normally.

### PAUSE/ STEP

Push **PAUSE** **||** on the remote control to make the playback pause.

Pushing **STEP** **||▶** again moves the picture forward frame by frame.

## BASIC OPERATIONS

### SELECT AUDIO LANGUAGE

You can choose the language according to your choice when playing multi-language DVD.

Press "AUDIO" button, select different languages.



#### Note:

1. Different disc has different languages
2. You can push "AUDIO" button to choose the language you want when you play multi-language DVD discs.

#### \*Attention:

Please select the AUDIO language in SETUP menu to keep the setting!!!

### SELECT CHANNELS (CD, MP3)

You may select the right channel or left channel or stereo from a multi-channel.

Push "CHANNEL" button, the screen show alternately and select the desired audio channel:

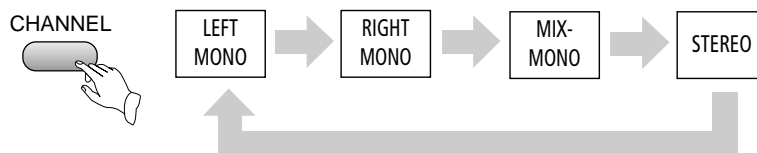

#### Note:

You can use channel function when you play the disc, you can choose mono audio output ( left or right channel ), stereo or mix-mono

### SELECTING 3D AUDIO

This function outputs 3D effects on the stereo audio analog output where 3D effects are broken down into 7 surround modes.

- 1 **Press [3D] button.**  
Every time the user presses [3D] button, CONCERT, LIVING ROOM, HALL, BATHROOM, CAVE, ARENA and CHURCH appear one by one.
- 2 **Select the desired 3D sound mode.**

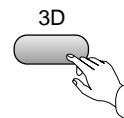
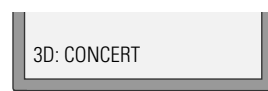

## PLAYING A DESIRED SCENE

### ■ TO SKIP SCENES IN A DISC

- 1 Push **▶▶I** to move to the next chapter (or track).  
The current chapter (or track) moves to the next chapter (or track).
- 2 Push **I◀◀** to move to previous chapter (or track).  
The current chapter (or track) moves to the previous chapter (or track) or first scene of current chapter (or track).

### ■ DIRECTLY MOVING TO A DESIRED TITLE (DVD)

Some movie discs may contain multiple titles. If the disc has a movie title menu recorded on it, the [TITLE/PBC] button can be used to select the movie title. Details of operation may differ depending on the disc used.

- 1 Push the [TITLE/PBC] or [MENU] button.  
A list of the titles on the disc is displayed.  
If using some disc, the menu screen will appear only when the disc has PBC function and PBC ON is activated.



**Note:**

*You can select the desired title directly by using number button.*

\* In the case of PBC play, press RETURN to return to the sub-menu, press it again to return to the home menu.

- 2 Push the [PLAY] button after pressing the [**◀▶▲▼**] or number button to select the desired title.  
The selected title now starts playing.

## PLAYING A DESIRED SCENE

### PLAYING A DISC CONTAINING MP3 FILES

- 1 When a MP3 disc is loaded, MP3 menu screen is displayed automatically depending on MP3 disc's folder structure.
- 2 Use the direction button to select the folder you want to play, by pressing [PLAY] button. This button allows you to see the file lists under the folder.
- 3 Use the direction button and select a MP3 title using the PLAY button then play will start automatically. When you know the title number, enter the MP3 title number using the numeric buttons on the remote control and then press [PLAY] button.
- 4 Press **▶▶** on the remote control to choose next title (next files in play mode). Press **◀◀** for previous title (previous files in play mode).

When you know the title number, enter MP3 title number using the numeric buttons on the remote control and then press [PLAY] button.

### REPEAT PLAY

When play a DVD disc, this function can be used to repeatedly play a title, chapter or disc.

Push "REPEAT" button, the screen shows orderly.

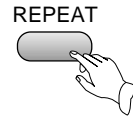

**Note:**  
Push REPEAT to cancel the repeat function.

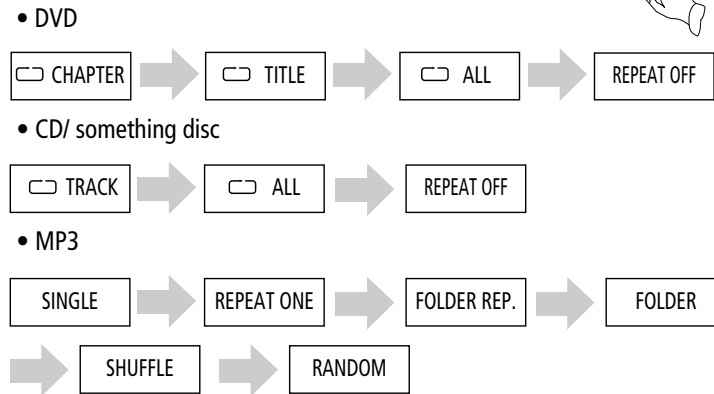

## PLAYING A DESIRED SCENE

### REPEATING A DEFINED PERIOD FROM A TO B

You may press A-B to enjoy some parts repeatedly when playing a disc.

1. Press "A-B" to set a starting point A.
2. Press "A-B" twice to an end point B.  
Afterwards, the unit plays from A to B.
3. Press "A-B" three times to remove A-B repeat.

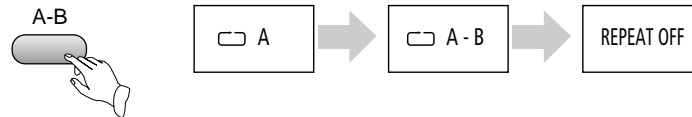

### SELECT A SUBTITLE LANGUAGE

When play a multi-subtitle DVD, you may select one subtitle to show it on the screen.

#### Note:

1. For some discs, subtitles cannot be removed.
2. Subtitle function is only available for some discs with subtitle recorders.

- 1 **Keep pressing [SUBTITLE] button till the user's preferred language appears.**

If a DVD disc includes subtitle information, every time the user presses [SUBTITLE] button, ENGLISH, FRENCH, SPANISH and others appear one by one.

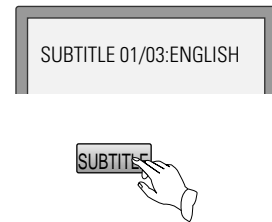

- 2 **Remove the subtitle.**  
Press SUBTITLE until the screen shows "SUBTITLE OFF".

## PLAYING A DESIRED SCENE

### SEARCHING

#### SEARCHING DVD WITH A TITLE/CHAPTER NUMBER OR A TIME

■ You may directly enter a title or chapter number to search fast on a disc. The unit plays from the point.

1 If you want to search with a chapter or a title number, press [SEARCH] button.

It shows the current disc mode; TITLE, CHAPTER, AUDIO, SUBTITLE, ANGLE, REPEAT, TIME Disp..

Select the TITLE or CHAPTER and enter the new chapter or title number to be searched using the [PLAY], [NUMBER] and [◀▶▲▼] buttons.

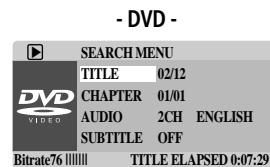

2 In completing entering, please press [SEARCH] button. PLAY starts from the selected position.

#### SEARCHING CD AND SOMETHING DISC WITH A TIME OR TRACK TIME

1 You may directly enter a disc or track time to search fast on a disc. The unit plays from the point.

• If you want to search with a track number, press [SEARCH] button.

It shows the current disc mode; TRACK, DISC TIME, TRACK TIME, REPEAT, TIME Disp..

Select the TRACK and enter the new track number to be searched using the [PLAY], [NUMBER] and [◀▶▲▼] buttons.

In completing entering, please press [SEARCH] button. PLAY starts from the selected position.



• If you want to search with a disc time, press [SEARCH] button.

Select the DISC TIME and enter the new time to be searched using the [PLAY], [NUMBER] and [◀▶▲▼] buttons.

2 If you want to search with a track time of CD, press [SEARCH] button.

Select the TRACK TIME and enter the new time to be searched using the [NUMBER] buttons.



# PLAY DISCS IN VARIOUS WAYS

## SELECT ANGLE

**Note:**  
Multi Angle function is limited to a DVD disc supporting multi angle information.

Some discs have images with different screen angles, you may select among them. For example, when you watch a running train, you may select to watch it from the front, the left window or the right window without stopping it.

Keep pressing [ANGLE] button till the preferred angle appears.

-  2/4 (select ANGLE2)
-  3/4 (select ANGLE3)
-  4/4 (select ANGLE4)



ANGLE



## ZOOM PLAY

This function can be used to enjoy a motion or motionless picture.

- 1 Push "ZOOM" button when playing, the screen shows orderly:

ZOOM

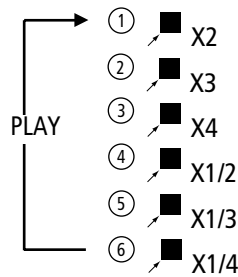
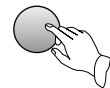

- 2 Push "UP/DOWN/LEFT/RIGHT [◀▶▲▼] button to move the enlarged picture.

## BOOK MARK

**Note:**  
If you erase a book mark function, push "RETURN" button.

- 1 Push MARK button, the screen will show the following frame:

- 2 Moving direction button to select the saving position on the screen. Push PLAY button to save the time tag.

- 3 Push MARK button when you need book mark function, then choose the item you want to resume playing, then push PLAY button to continue playing from the saving point.

	02			05	
	08				



## PLAY DISCS IN VARIOUS WAYS

### PROGRAM PLAY (DVD)

You may program the title and chapter on a disc and play them in the programmed order.

- 1 Push "PROGRAM" button, the screen shows:

PROGRAM

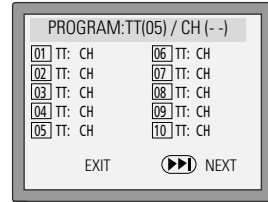
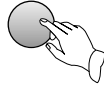

- 2 Input the sequence number you want to program playing.

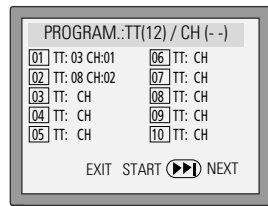

- 3 After the programming is finished, move cursor to "START" by direction button and push "PLAY" button to start playing.

- 4 Push "STOP" button two times to remove program play.

\* If you want to remove any program no, put the cursor in the position of the program number, push "RETURN" button.

#### Note:

- First one is title, second one is chapter.
- If the disc has only one title, TT will not be displayed.

### PROGRAM PLAY (CD)

You may program the track on a disc and play them in the programmed order. (For MP3 play, refer to 28 page)

- 1 Push "PROGRAM" button, the screen shows:

- 2 Push direction button, input the sequence number you want to program playing.

After the programming is finished, push direction button to select "START", Push "PLAY" button to start playing.

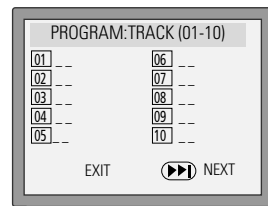

## PLAY DISCS IN VARIOUS WAYS

### DIGEST PLAY (DVD)

1 Push "INTRO" button when the unit is playing disc, the screen shows :

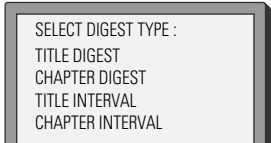

SELECT DIGEST TYPE :  
TITLE DIGEST  
CHAPTER DIGEST  
TITLE INTERVAL  
CHAPTER INTERVAL

2 Push direction button to select the digest type. And push "PLAY" button.

INTRO

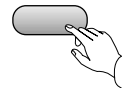

Note:

- **TITLE DIGEST**

The player will play 5 seconds each title. After moving the cursor in the position "--", push NUMBER button to select the title and push PLAY button. Then the player will begin to play from the title you selected. Or put the cursor in the position of desired picture and push PLAY button.

- **CHAPTER DIGEST**

The player will display the beginning picture of each chapter in current selected title.

- **TITLE INTERVAL**

Scan the story in the disc from 00:00:00 on, the unit will play the disc every other 10 minutes.

- **CHAPTER INTERVAL**

Scan the story in the current title from 00:00:00 on, the unit will play the disc every other 10 minutes.

### DIGEST PLAY (something disc)

1 Push "INTRO" button when the unit is playing disc, the screen shows :

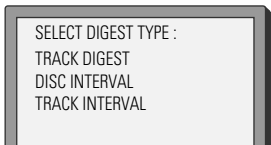

SELECT DIGEST TYPE :  
TRACK DIGEST  
DISC INTERVAL  
TRACK INTERVAL

2 Push direction button to select the digest type. And push "PLAY" button.

INTRO

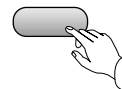

Note:

- **TRACK DIGEST**

The player will play 5 seconds each track. Push NUMBER button to select the track, then push PLAY button, the player will begin to play from the track you selected.

- **DISC INTERVAL**

Scan the story in the disc from 00:00:00 on, the unit will play the disc every other 10 minutes.

### DIGEST PLAY (CD)

1 Push "INTRO" button when the unit is playing disc, the screen shows :

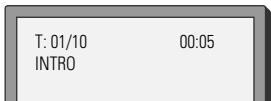

T: 01/10      00:05  
INTRO

2 The player will play 5 seconds each track.

## PLAY DISCS IN VARIOUS WAYS

### ■ PLAY MP3 OR PIC-CD DISC

#### ■ USE NUMBER BUTTONS TO SELECT TRACKS (MP3 OR PIC-CD)

**1** The screen will display as right after the disc is loaded

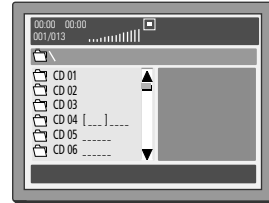

**2** Each time you press PROGRAM button, FOLDER and FILE LIST appear one by one.

At this time you can select the item in the list.

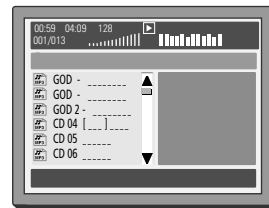

**3** You can select the file you want using direction buttons.

**4** Press PLAY button after selecting the file you want.  
The file will be played back.

## PLAY DISCS IN VARIOUS WAYS

### ■ SELECT PLAYING MODE (MP3 OR PIC-CD)

Push "REPEAT" button, you can select "SINGLE", "REPEAT ONE", "FOLDER REPEAT", "FOLDER", "SHUFFLE" and "RANDOM".

- Single mode: the player will stop after finished playing the current item
- Repeat one mode: repeat the current item
- Repeat folder mode: repeat the items in the current directory
- Shuffle mode: play items by random
- Folder mode: the player will stop after finished playing the whole directory

### ■ PLAY PIC-CD BY ZOOM OR ROTATING OPERATING (PIC-CD)

The screen will show "ZOOM 100%" when you push ZOOM button under playing status, the current picture can be zoomed by push ►► or ◀◀ button, and the screen will also show the zoom ratio of the picture ( ZOOM 100%, ZOOM 125%, ZOOM 150%, ZOOM 200%, ZOOM 75%, ZOOM 50% ). The picture will restore to the normal status if you push PLAY button under the ZOOM status.

# FUNCTION SETTING

## ■ MENU SETTING

According to the recorded information and external equipment, set the following functions for DVD to obtain the best playing status. Push "SETUP" button to set the main menu.

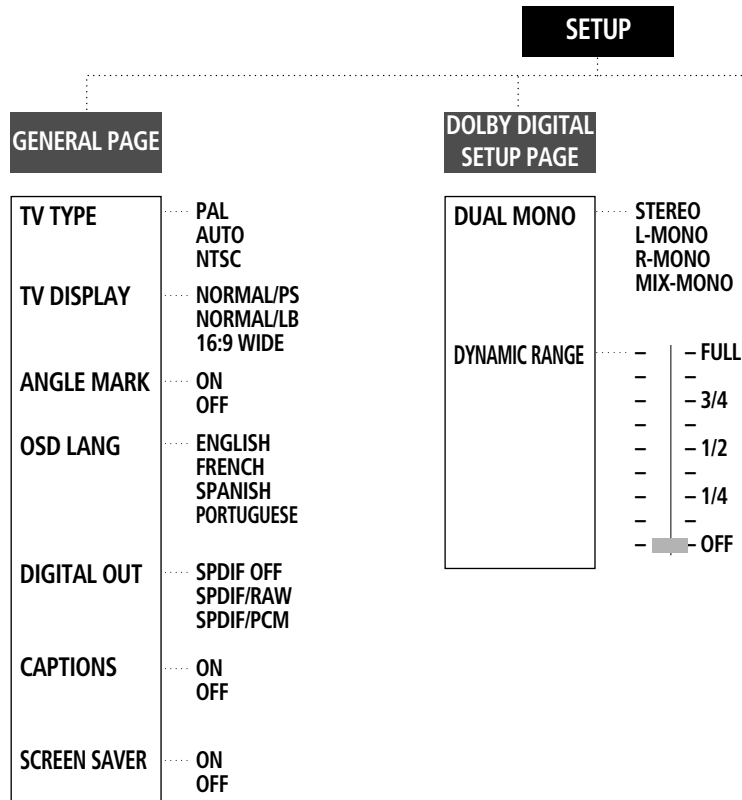

## FUNCTION SETTING

### BASIC NAVIGATION

To navigation through the setting on the screen, use the direction buttons to scroll through the list of settings and use "PLAY" button to select the high lighted function.

### SETUP MENU

Press the SETUP button to enter the On Screen Display and to exit at any time. In each of the menus, selecting MAIN PAGE (SETUP menu) will immediately return you to the initial screen.

#### PREFERENCES PAGE

<b>AUDIO</b>	ENGLISH FRENCH SPANISH CHINESE JAPANESE KOREAN RUSSIAN THAI
<b>SUBTITLE</b>	ENGLISH FRENCH SPANISH CHINESE JAPANESE KOREAN RUSSIAN THAI
<b>DISC MENU</b>	ENGLISH FRENCH SPANISH CHINESE JAPANESE KOREAN RUSSIAN THAI
<b>PARENTAL</b>	1 KID SAFE 2 G 3 PG 4 PG-13 5 PG-R 6 R 7 NC-17 8 ADULT NO PARENTAL
<b>PASSWORD</b>	CHANGE
<b>DEFAULTS</b>	RESET

## FUNCTION SETTING

### ■ GENERAL SETUP

#### ■ TV TYPE

You may select according to the colour system of the TV to be connected.

- Select "PAL" for a PAL TV.
- Select "AUTO" for a multi-system TV.
- Select "NTSC" for a NTSC TV.

#### ■ TV DISPLAY

##### 1 NORMAL/PS

This is selected when the unit is connected with a normal TV. Wide-screen images are shown on the screen, but with some parts cut automatically.



##### 2 NORMAL/LB

This is selected when the unit is connected with a normal TV. Wide-screen images are shown on screen, with black belts on the top and bottom.



##### 3 16:9 WIDE

This is selected when the unit is connected with a wide-screen TV.



#### ■ ANGLE MARK

This only works when there is an angle mark on the disc.

- Select "ON", the screen shows the mark when playing a DVD.
- Select "OFF", the mark is not shown.

## FUNCTION SETTING

**Note:**

*"OSD" means  
"On Screen  
Display".*

### ■ OSD LANGUAGE

---

When select a language, the screen show this language.

For example, if you select ENGLISH, the OSD is in English.

### ■ AUDIO OUTPUT

---

- **SPDIF OFF**

No signal is output from the coaxial, optical port.

- **SPDIF/RAW**

Select this when the DVD player is connected with a power amplifier through optical or coaxial port. Please refer to the page 14. when a Dolby Digital DVD, DTS DVD or MPEG DVD is played, select this, the coaxial or optical port will output in the corresponding digital format (source code). The power amplifier to be connected must have Dolby Digital, DTS and MPEG DVD is played, the optical or coaxial port will output in PCM 2-channel format.

- **SPDIF/PCM**

Select this when the DVD player is connected with a TV or a power amplifier through audio cord.

### ■ CAPTIONS

---

The hidden subtitle is shown or turn off.

### ■ SCREEN SAVER

---

Start the screen saver, the screen saver image appears when the unit stops or the image is motionless for a few seconds. This saver can keep the screen from being damaged.



## FUNCTION SETTING

### ■ DOLBY DIGITAL SETUP

#### ■ DUAL MONO

This is the output mode of the L and R signals of the set audio output. If it is set to "MIX MONO", the function only works when the DVD being played is 2.0-channel.

- **STEREO**  
Choose this option, the audio output should be dummy stereo signal.
- **L-MONO**
- **R-MONO**
- **MIX-MONO**

#### ■ DYNAMIC RANGE

Set "Off" to view a program in the dynamic range as recorded in disc. If you hear loud sound softer and soft sound louder, set "Full".

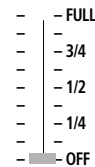

### ■ PREFERENCE SETUP

#### ■ AUDIO

- **Selecting an audio language.**

Set it as the preferred audio language. In case the audio language is set and recorded in the DISC, it is automatically played in the set language in every playing. For example, English is set and recorded as audio language in the DISC, it is played in English.

#### ■ SUBTITLE

- **Selecting Subtitle language.**

Please set it as the preferred language. In case the subtitle language is set and recorded in the DISC, it is automatically played in the set language in every playing. For example, English is set and recorded as subtitle language in the DISC, it is played in English.

## FUNCTION SETTING

### ■ DISC MENU

#### • Selecting Disc Menu language.

Please set it as the preferred DISC MENU language. In case the DISC MENU language is set and recorded in the DISC, it is automatically played in the set language in every playing. For example, English is set and recorded as a DISC MENU language in the DISC, it is played in English.

### ■ PARENTAL

The content of a disc with lock function is evaluated by grades. You can select an age grade as your need.

#### Note:

*The password is set by yourself.*

Example: Select "1 KID SAFE", the scenes of violence inadvisable to children are not played.

For adults, the screen suggests you enter the code after pushing "PLAY" button, you can watch if the code is right.

### ■ PASSWORD

Select "PASSWORD" in PREFERENCE SETUP menu to setup password, input a password.

#### Note:

*The password is 3308 when the unit is turned on initially or you forget the password.*

Enter a password according to the screen.

OLD PASSWORD	<input type="text"/>
NEW PASSWORD	<input type="text"/>
CONFIRM PASSWORD	<input type="text"/>
<input type="button" value="OK"/>	

### ■ DEFAULT>> RESET

Each function setting returns to the factory initial status if you select this.

## OTHERS

### ■ TROUBLESHOOTING

If you experience the following problems while using the unit, this troubleshooting guide can help you.

- **NO SOUND**

- Check if the unit is connected securely.
- Make sure you operate the TV or amplifier correctly.

- **NO IMAGE , IMAGE ROLLS AND NO COLOR**

- Check if the unit is connected securely.
- Make sure you operate the TV correctly.
- Make sure you set the color system correctly.

- **BAD SOUND QUALITY**

- Make sure the audio output mode is set correctly.
- Make sure the audio connection between the unit and amplifier is right.

- **DISC CAN NOT BE PLAYED**

- There is no disc in the unit.
- Insert the disc on the disc tray properly with the label side up.
- Clean the disc.
- Moisture has condensed in the unit.  
Remove the disc and leave the unit on for about one hour.

- **SCREAMING**

- Keep the phone far away from the speaker
- Turn down the volume
- Turn down the volume of phone and echo.

- **REMOTE CONTROL DOES NOT WORK**

- Remove barriers between the remote control and the unit.
- Replace the batteries with new ones.
- Point the remote control at the remote control sensor of the unit.

- **ATTENTION: KEEPING THE STATUS OF STOP MORE THAN 5 MINUTES ENTERS SCREEN SAVE MODE. WHEN THE SCREEN SAVE MODE IS KEPT MORE THAN AN HOUR, THE SET ENTERS STAND-BY MODE.**

**OTHERS****TECHNICAL SPECIFICATIONS**

Laser		wavelength 650nm
Video		PAL/AUTO/NTSC
Frequency response		20Hz ~ 20KHz ( $\pm 1$ dB)
Signal/noise ratio		$\geq 90$ dB
Channel separation		$\geq 85$ dB ( 1KHz)
Dynamic range		$\geq 80$ dB ( 1KHz)
Output Audio	Analog	output level : 2.0 + 0/-0.2Vrms (Load impedance : 10K $\Omega$ )
	Digital	output level : 0.5 $\pm$ 0.1Vp-p (Load impedance : 75 $\Omega$ )
Output Video	Composite	output level : 1.0 $\pm$ 0.1Vp-p (Load impedance : 75 $\Omega$ , imbalance, negative polarity)
	S-video	output level : brightness (Luma) 1.0 $\pm$ 0.1Vp-p chromaticity (Clor) 0.286 $\pm$ 20% (Load impedance : 75 $\Omega$ )
	Component	Y: 1Vp-p, Pb/Pr: 0.7Vp-p (Load impedance : 75 $\Omega$ )
Power		AC 120V~, 50Hz/60Hz 12W
Dimensions	Body (W x H x D)	430 x 38 x 260 mm
	Packing	510 x 88 x 310 mm
Weight (Gross/ Net)		3.5Kg / 2.6Kg

Notes : Design and specifications in this owner's manual are subjected to change without prior notice to improve quality and function.

# WARRANTY

DEAM (Daewoo Electronics America) warrants each new electronic product manufactured by it to be free from defective material and workmanship and agrees to remedy any such defect or to furnish a new part (at the Company's option) in exchange for any part of any unit of its manufacture which under normal installation, use and service disclosed such defect, provided the unit is delivered by the owner to us or to our authorized distributor from whom purchased or authorized service station intact, for our examination with all transportation charges prepaid to our factory. To establish and receive warranty service at our factory or authorized service facilities, proof of purchase/dated sales invoice is required. Written authorization must be obtained before any merchandise is returned to the factory.

This warranty does not extend to any of our electronic products which have been subjected to misuse, neglect, accident, incorrect wiring not our own, improper installation, unauthorized modification, or used in violation of instructions furnished by us, nor units which have been repaired or altered outside of our factory, nor to cases where the serial number thereof has been removed, defaced or changed.

This warranty is in lieu of all warranties expressed or implied and no representative or person is authorized to assume for us any other liability in connection with the sale of our electronic products.

## Over-the-counter exchange of initially defective units

A unit is described as initially defective when the dealer opens the unit and finds that it is inoperative or a customer opening a new unit finds that it is initially defective. This unit may be returned to the factory by the dealer for exchange. Under no circumstances will a customer be permitted to return an initially defective unit directly to the factory.

Model	Parts	Labor
DVG-9100N/ DVG-9200N	1 Year	3 months

This instrument is listed by Underwriter's Laboratories, Inc. It is designed and manufactured to meet rigid U.L. safety standards against X-radiation, fire, casualty and electrical hazards.



### Daewoo Electronics

America Inc.

120 Chubb Ave,  
Lyndhurst, NJ 07071 USA

For more information about this or other Daewoo products, call 1-800-DAEWOO8.

## Free Manuals Download Website

<http://myh66.com>

<http://usermanuals.us>

<http://www.somanuals.com>

<http://www.4manuals.cc>

<http://www.manual-lib.com>

<http://www.404manual.com>

<http://www.luxmanual.com>

<http://aubethermostatmanual.com>

Golf course search by state

<http://golfingnear.com>

Email search by domain

<http://emailbydomain.com>

Auto manuals search

<http://auto.somanuals.com>

TV manuals search

<http://tv.somanuals.com>