

DAEWOO

DVD PLAYER

Owner's Manual

DQD-6100D/DQD-2100D

- ◆ Region code of DVD player for home is Region 2 or ALL. In inserting a disc with other region code, it does not operate. Please only use a disc with region 2 code or ALL.
- ◆ ☹ is a "DO NOT" mark. If this mark is displayed in operating the units, please wait for a while, then use it. If "☹ DO NOT" mark continues to be displayed in pressing a button after that, it means the button does not function in the currently playing disc.



HELP LINE ; 0118 925 2577

With queries, please quote the page number, reference number and model number.

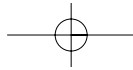

Advantages of This Product Are

- ✓ **DVD, VCD, CD, CD-R(MP3), CD-RW playback function**
- ✓ **MP3 file playback function (CD-R disc having records of MP3 files)**
- ✓ **Various TV system supported (NTSC and PAL)**
- ✓ **OSD (On Screen Display)**
: Press [DISPLAY] button, disc and device information of DVD/VCD/CD are displayed.
- ✓ **Screensaver function**
- ✓ **3D sound effect (3D sound effect using 2 speakers)**
- ✓ **High performance video (27MHz / 10 bit)**
: You can get sharp picture of DVD by using a 27MHz / 10bit video converter.
- ✓ **High performance audio (96KHz / 24 bit)**
: You can experience DVD standard high-performance audio by using 96KHz / 24bit high-performance audio converter.
- ✓ **Coaxial, Optical digital output (PCM, Dolby digital, dts)**
: You can enjoy high-level digital audio by connecting with amp embedded with Dolby digital / dts decoder.
- ✓ **Dolby digital decoder embedded**
- ✓ **Analog audio 2-channels output for DOWNMIX (x1)**
- ✓ **Composite video output (x1)**
- ✓ **S-Video output (x1)**
- ✓ **Uro (Scart) Jack Output (x1)**
- ✓ **Forward / reverse slow playback**
- ✓ **Forward / reverse speedy playback**
- ✓ **Search of title, chapter, and time in DVD disc, and search of track and time in VCD and CD**
- ✓ **Various TV aspect (DVD)**
: 4:3 for Pan and Scan, 4:3 for Letter Box, and 16:9 for Wide
- ✓ **Repeat playback (title and chapter for DVD, track and disc for VCD/CD)**
- ✓ **Bookmark function (DVD)**
: Playback position can be made to remember up to 3 positions for speedy search.

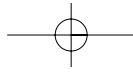

✓ **Selective Play (DVD/VCD/CD)**

: You can select and play the desired title / chapter of DVD and track of Video CD/CD in STOP mode.

✓ **Parental limit function (DVD)**

: You can prevent children from watching adult movies by Parental SET.

✓ **Multi-language voice audio (DVD)**

: You can change voice audio up to 8. For SVCD and VCD, it depends on disc. (number of voice audio differs by each disc)

✓ **Multi-language voice subtitles (DVD)**

: You can change subtitles up to 32. For SVCD and VCD, it depends on disc. (number of subtitles differs by each disc.)

✓ **Multi Angle screen (DVD)**

: You can select and watch a screen photographed in various angles simultaneously (number of photographed angle screen differs by each disc)

✓ **Screen zoom function (DVD/VCD)**

✓ **Thumbnail view function (in VCD with inactivated PBC)**

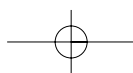

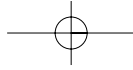

Important Safeguards

	CAUTION RISK OF ELECTRIC SHOCK DO NOT OPEN	
<p>CAUTION: TO REDUCE THE RISK OF ELECTRIC SHOCK, DO NOT REMOVE COVER (OR BACK). NO USER-SERVICEABLE PARTS INSIDE. REFER SERVICING TO QUALIFIED SERVICE PERSONNEL.</p>		



The lightning flash with arrowhead symbol, within an equilateral triangle, is intended to alert the user to the presence of uninsulated "dangerous voltage" within the product's enclosure that may be of sufficient magnitude to constitute a risk of electric shock.



The exclamation point within an equilateral triangle is intended to alert the user to the presence of important operating and servicing instructions in the literature accompanying the appliance.

WARNING : TO REDUCE THE RISK OF FIRE OR ELECTRIC SHOCK, DO NOT EXPOSE THIS APPLIANCE TO RAIN OR MOISTURE.

CAUTION : TO PREVENT ELECTRIC SHOCK, MATCH WIDE BLADE OF PLUG TO WIDE SLOT, FULLY INSERT.

IMPORTANT FOR LASER PRODUCTS

- **LASER :** This Digital Video Disc Player employs a Laser System. To ensure proper use of this product please read this owner's manual carefully and retain for future reference. Should the unit require maintenance, contact an authorized service location - see service procedure.
Use of control adjustments or the performance of procedures other than those specified may result in hazardous radiation exposure.
To prevent direct exposure to the laser beam, do not try to open the enclosure. Visible laser radiation when open and interlocks defeated.
DO NOT STARE INTO THE BEAM.
- **DANGER :** Visible laser radiation when open and interlock failed or defeated.
Avoid direct exposure to beam.
- **CAUTION :** Do not open the top cover. There are no user serviceable parts inside the Unit; leave all servicing to qualified service personnel.

**CLASS 1
LASER PRODUCT**

FCC NOTICE: This equipment has been tested and found to comply with the limits for a Class B digital device, pursuant to part 15 of the FCC Rule. These limits are designed to provide reasonable protection against harmful interference in a residential installation. This equipment generates, uses and can radiate radio frequency energy and if not installed and used in accordance with the instructions, may cause harmful interference to radio communications. However, there is no guarantee that interference will not occur in a particular installation. If this equipment does cause harmful interference to radio or television reception; which can be determined by turning the equipment off and on, the user is encouraged to try to correct the interference by one or more of the following measures:

- Reorientate or relocate the receiving antenna.
- Increase the separation between the equipment and receiver.
- Connect the equipment to an outlet on a circuit different from that to which the receiver is connected.
- Consult the dealer or an experience radio/TV technical for help.

CAUTION: Any changes or modification in construction of this device which are not expressly approved by the party responsible for compliance could void the user's authority to operate the equipment.

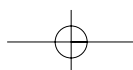

This set has been designed and manufactured to assure personal safety. Improper use can result in electric shock or fire hazard. The safeguards incorporated in this unit will protect you if you observe the following procedures for installation, use and servicing. This unit is fully transistorized and does not contain any parts that can be repaired by the user.

1 READ INSTRUCTIONS

All the safety and operating instructions should be read before the unit is operated.

2 RETAIN INSTRUCTIONS

The safety and operating instructions should be retained for future reference.

3 HEED WARNINGS

All warnings on the unit and in the operating instructions should be adhered to.

4 FOLLOW INSTRUCTIONS

All operating and use instructions should be followed.

5 CLEANING

Unplug this unit from the wall outlet before cleaning. Do not use liquid cleaners or aerosol cleaners. Use a damp cloth for cleaning.

6 ATTACHMENTS

Do not use attachments unless recommended by the unit's manufacturer as they may cause hazards.

7 WATER AND MOISTURE

Do not use this unit near water- for example, near a bath tub, wash bowl, kitchen sink or laundry tub, in a wet basement, or near a swimming pool.

8 ACCESSORIES

Do not place this unit on an unstable cart, stand, tripod, bracket, or table. The unit may fall, causing serious injury to a child or adult as well as serious damage to the unit. Use this unit only with a cart, stand, tripod, bracket, or table recommended by the manufacturer.

PORTABLE CART WARNING
(symbol provided by RETAC)



8A

A unit and cart combination should be moved with care. Quick stops, excessive force, and uneven surfaces may cause the video product and cart combination to overturn.

9 VENTILATION

Slots and openings in the case are provided for ventilation to ensure reliable operation of the unit and to protect it from overheating. These openings must not be blocked or covered. These openings must not be blocked by placing the unit on a bed, sofa, rug, or other similar surface. This unit should never be placed near or over a radiator or heat radiator. This unit should not be placed in a built-in installation such as a bookcase or rack unless proper ventilation is provided or the manufacturer's instructions have been adhered to.

10 POWER SOURCES

This unit should be operated only from the type of power source indicated on the marking label. If you are not sure of the type of power supply to your home, consult your video dealer or local power company. For units intended to operate from battery power, or other sources, refer to the operating instructions.

11 GROUNDING OR POLARIZATION

This unit is equipped with a polarized alternating-current line plug (a plug having one blade wider than the other). This plug will fit into the power outlet only one way.

This is a safety feature. If you are unable to insert the plug fully into the outlet, try reversing the plug. If the plug still fails to fit, contact your electrician to replace your obsolete outlet. To prevent electric shock, do not use this polarized plug with an extension cord, receptacle, or other outlet unless the blades can be fully inserted without blade exposure. If you need an extension cord, use a polarized cord.

12 POWER-CORD PROTECTION

Power-supply cords should be routed so that they are not likely to be walked on or pinched by items placed upon or against them, paying particular attention to cords at plugs, convenience receptacles, and the point where they exit from the unit.

13 LIGHTNING

For added protection for this unit during a lightning storm, or when it is left unattended and unused for long periods of time, unplug it from the wall outlet and disconnect the antenna or cable system. This will prevent damage to the unit due to lightning and power line surges.

14 DISC TRAY

Keep your fingers well clear of the disc as it is closing. It may cause serious personal injury.

15 OVERLOADING

Do not overload wall outlets of extension cords as this can result in a risk of fire or electric shock.

16 OBJECT AND LIQUID ENTRY

Never push objects of any kind into this unit through openings as they may touch dangerous voltage points or "short-out" parts that could result in a fire or electric shock. Never spill liquid of any kind on the unit.

17 BURDEN

Do not place a heavy object on or step on the product. The object may fall, causing serious personal injury and serious damage to the product.

18 DISC

Do not use a cracked, deformed or repaired disc. These discs are easily broken and may cause serious personal injury and product malfunction.

19 SERVICING

Do not attempt to service this unit yourself as opening or removing covers may expose you to dangerous voltage or other hazards. Refer all servicing to qualified service personnel.

20 DAMAGE REQUIRING SERVICE

Unplug this unit from the wall outlet and refer servicing to qualified service personnel under the following conditions.

- A. When the power-supply cord or plug is damaged.
- B. If liquid has been spilled, or objects have fallen into the unit.
- C. If the unit has been exposed to rain or water.
- D. If the unit does not operate normally by following the operating instructions. Adjust only those controls that are covered by the operating instructions. Improper adjustment of other controls may result in damage and will often require extensive work by a qualified technician to restore the unit to its normal operation.
- E. If the video product has been dropped or the cabinet has been damaged.
- F. When the unit exhibits a distinct change in performance-this indicates a need for service.

21 REPLACEMENT PARTS

When replacement parts are required, have the service technician verify that the replacements he uses have the same safety characteristics as the original parts. Use of replacements specified by the unit manufacturer can prevent fire, electric shock, or other hazards.

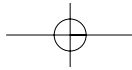

22 SAFETY CHECK

Upon completion of any service or repairs to this unit, ask the service technician to perform safety checks recommended by the manufacturer to determine that the unit is in safe operating condition.

23 WALL OR CEILING MOUNTING

The product should be mounted to a wall or ceiling only as recommended by the manufacturer.

24 HEAT

The product should be situated away from heat sources such as radiators, heat registers, stoves, or other products (including amplifiers) that produce heat.

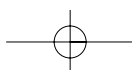

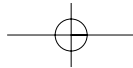

Read Carefully before Using

Cautions in use of DVD player are described below.

Please read carefully before using a DVD player.

✓ Installation place and handling

- When you place this player near other devices, they may affect poorly together.
- When you place this player near strong magnetic materials, it may affect image or voice poorly or damage recording.
- Do not spill volatile liquids like insect spray over the player. Do not leave rubber or plastic products in contact with the player for a long time. They will cause deterioration or paint peel-off.

✓ Not in use

- When the unit is not in use, be sure to remove the disc and turn off the power.
- If you do not use the unit for a long period, remove batteries in REMOTE to prevent leakage.
- In case you don't use the unit for a long time, the unit may not function properly in the future. Turn on and use the player occasionally.

✓ Moving

- Repack the unit as it was originally packed at the factory. Alternatively, pack this product with towel not to be damaged.
- Eject any disc.

✓ Cleaning

- Dust off dirt in cabinet or control panel part smoothly with a soft cloth.
- For heavy dirt, soak the cloth in a weak detergent solution, wring it well and wipe. Use a dry cloth to wipe it out.
- Follow instructions in using chemical cleaners.
- Do not use any type of solvent such as gasoline or benzene, as they may cause deterioration or paint peel-off.

✓ Checking

- For checking, contact your dealer or your nearest service center.

✓ Disc Handling

- Do not use any disc below.
 - Disc stained with juice or attachments
 - Disc with severe scratch
- Do not store the following places.
 - High temperature and humidity
 - Subject generation of mold
 - Subject to direct sunlight
 - Much dirt or dust
 - Near strong magnetic materials such as speaker

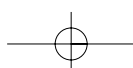
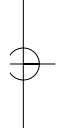

Contents

Product Information

Advantages of This Product Are	1
Important Safeguards	3
Read Carefully before Using	7
Contents	8
Identification of Controls	9
Remote Control	12

Installation

Connecting with TV	14
Connecting with Stereo Unit.....	15
Connecting TV with S-Video Jack, Dolby Digital Amp with Digital Audio Out Jack	16
Connecting with Amplifier Having 5.1 Channel Analog Terminals	17

DVD Operation

DVD Playback	18
Skipping from a current scene to a desired scene	20
Confirming the current PLAY mode on screen	27
Selecting an AUDIO language, SUBTITLE language and 3D AUDIO	28
Selecting ZOOM and Multi Angle	29
Memorising a scene.....	30
Displaying menus in a disc.	31

Setup

Basic SETUP Mode	32
LANGUAGE Setup.....	33
VIDEO Setup	34
AUDIO Setup	35
SPEAKER Setup.....	37
Other Setup	39

The others

About DVD.....	41
Before doubting about troubles	44
Specifications	46
Region Code	47

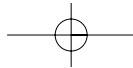

Identification of Controls

○ Main body (front panel)

✓ {DQD-6100D}

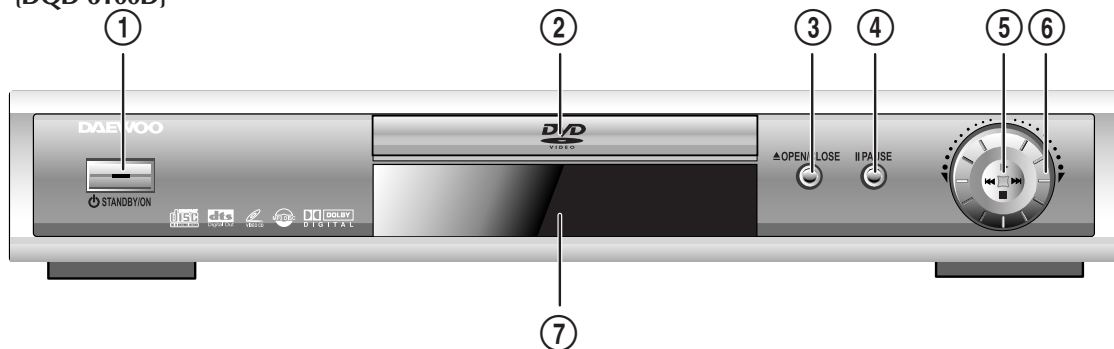

✓ {DQD-2100D}

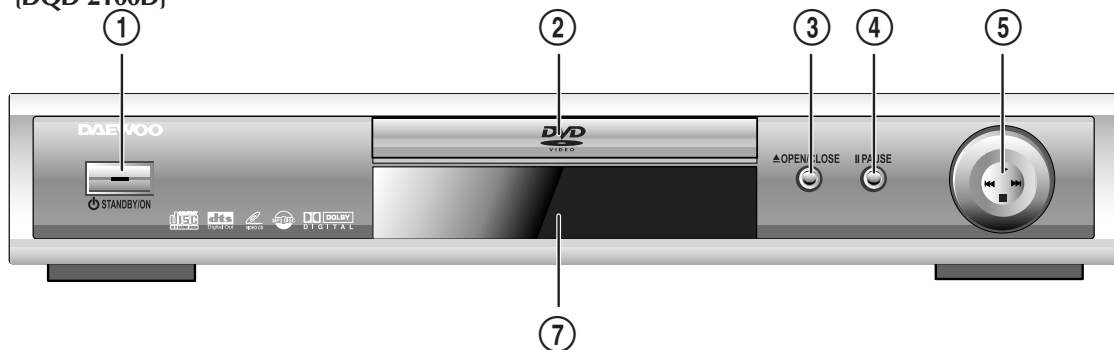

① **POWER (STANDBY/ON) button**

Use to power the device on/off if AC power supply is connected.

② **Disc tray**

③ **OPEN/CLOSE Tray button**

④ **PAUSE button**

⑤ **Operation button**

Playback (▶), Stop (■), Previous (▶▶) and Next (◀◀) operation can be selected with this button.

⑥ **JOG-Ring**

Use to wind currently being played disc, or to playback rapidly in clockwise. And use to rewind currently being played disc, or to playback back rapidly in counter-clockwise.

In Pause mode, rotating this jog ring make screen advance frame by frame.

⑦ **Operation Display Window**

Display operation of device.

For more information, see "Operation Display Window" in the next page.

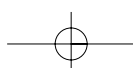
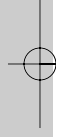
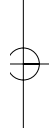

Operation Display Window

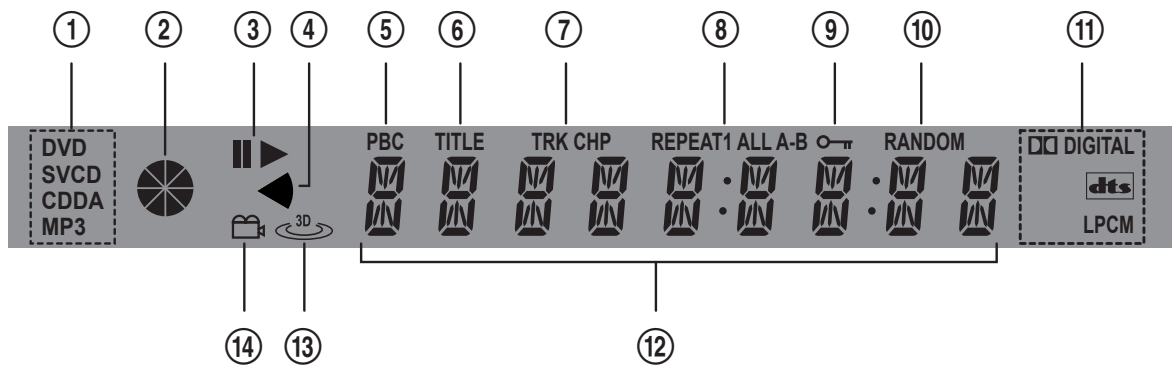

① Recognised DISC TYPE indicator

DVD, SVCD, VCD, CDDA, MP3

② DISC LOAD/PLAY indicator

This indicator is lighted up after recognizing disc.

③ PLAY/PAUSE indicator

Use to copy contents of disc into videotape.

④ VOLUME button

Size of this button is changed with every press.

⑤ VCD2.0/SVCD PBC indicator

This indicator is lighted up in selecting PBC ON while this indicator disappears in selecting PBC OFF.

⑥ DVD TITLE indicator

This indicator is lighted up if title number is displayed in playing DVD.

⑦ TRACK/CHAPTER indicator

This indicator is lighted up if Chapter(DVD) or track(VCD/ SVCD/ CDDA/ MP3) number is displayed.

⑧ REPEAT MODE indicator

REPEAT 1 : In case you want to repeat and play a chapter or track
 REPEAT ALL : In case you want to repeat and play a title or disc
 REPEAT A- : In case you want to set "A- Repeat"
 REPEAT A-B : In case you want to set "A-B Repeat"

⑨ PARENTAL LIMIT indicator

This indicator is lighted up if parental limit in "Select Function" menu is set items except "8 ADULT(RELEASE)". This indicator disappears in setting the parental limit to "8 ADULT(RELEASE)".

⑩ RANDOM indicator

⑪ DVD AUDIO STREAM indicator

DIGITAL : Dolby digital audio

: DTS audio

LPCM : LPCM audio

⑫ NUMBER/CHARACTER indicator

Title, chapter number, and time are displayed in loading DVD disc while track number and time are displayed in loading VCD/SVCD/CDDA/MP3 disc.

: Tray is opened

: Tray is closed

: Disc is loaded

: There is no disc in tray

: Disc has some error

: Menu screen is displayed

: Setup menu is displayed

: Power is ON

: Power is OFF

⑬ 3D SOUND indicator

This indicator is lighted up in selecting 3D SOUND (3D) button.

⑭ ANGLE indicator

This indicator is lighted up if disc contains Angle screen. (But, SETUP menu - OTHERS - ANGLE MARK indicator should be set to ON.)

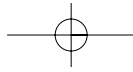

Main body (Rear Panel)

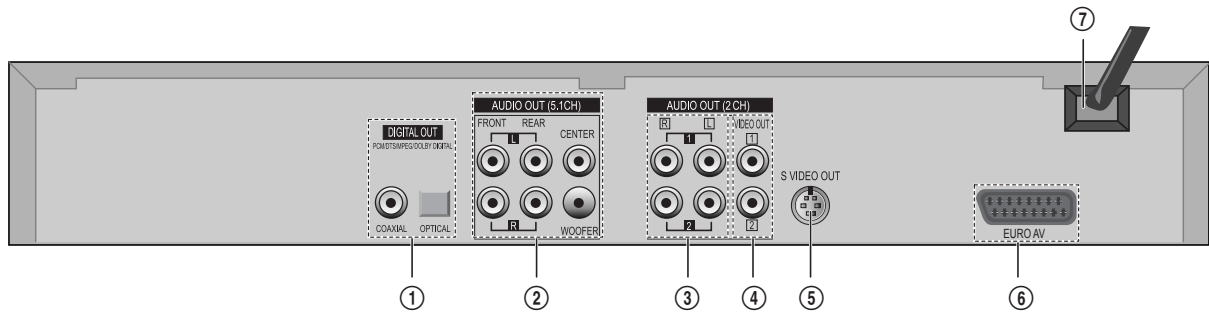

① DIGITAL OUTPUT (COAXIAL, OPTICAL) Jack

To enjoy sound quality of theatre level in home, connect this jack with amp or unit embedded with digital audio decoder.

② 5.1 CHANNEL ANALOG AUDIO OUT Jack

For Dolby digital and dts, total 6 channels are used; 3 channels for the front panel, 2 channels for surround, and 1 channel for subwoofer.

These channels are located in right, left, centre of front panel for 3 channels, right and left of rear panel for 2 channels, and centre of front panel for a channel. L and R means left side and right side respectively, CENTRE means central side, and SUB means subwoofer.

③ 2 CHANNEL (DOWNMIX) AUDIO OUT Jack

④ VIDEO OUTPUT Jack

⑤ S-VIDEO OUT Jack

To obtain better screen quality, connect and use the unit to TV or monitor inputted from S-VIDEO.

⑥ SCART Jack

⑦ POWER CORD

It is a jack for supplying power to the unit. Connect to outlet in a wall.

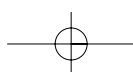

Remote Control

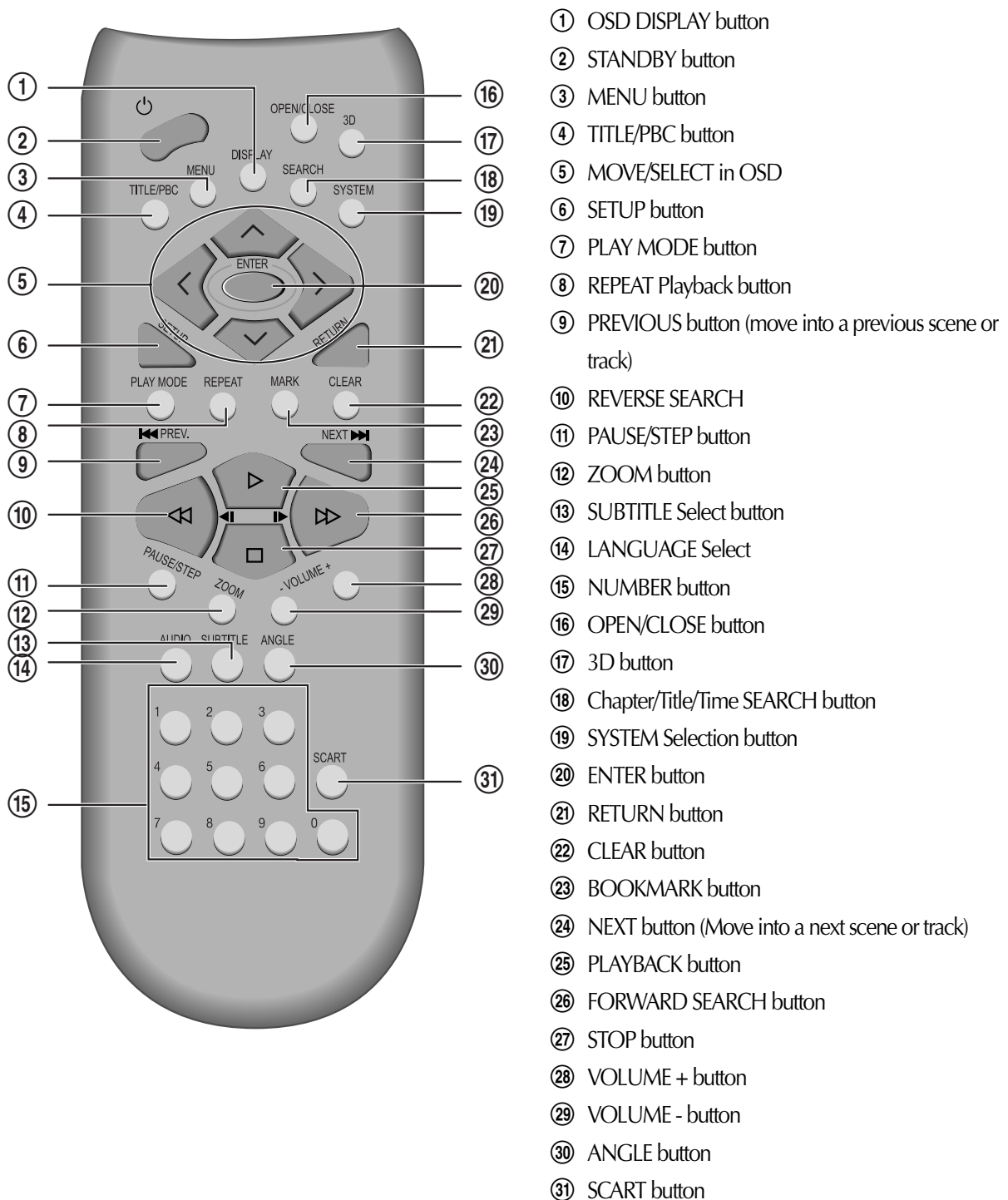

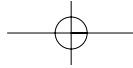

Instructions in Using REMOTE

- Operate REMOTE within 7m from the unit.
- Do not press 2(two) buttons at the same time.

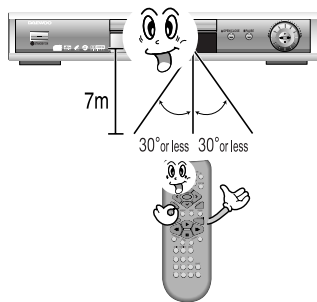

- Do not light up sending and receiving part of REMOTE.

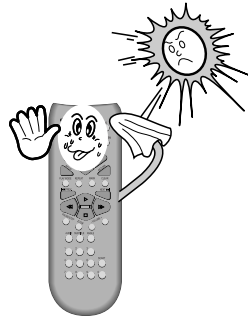

- Do not keep in the place with much dust and humidity.

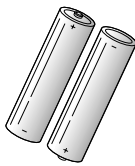
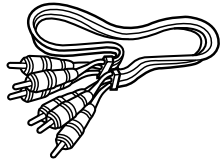
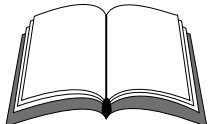

Accessories

<p>REMOTE</p> 	<p>2 Batteries</p> 	<p>Connecting cable to Audio/Video jack</p> 	<p>Owner's Manual/ Warranty</p> 
--	---	---	--

- To purchase accessories or not supplied parts additionally, contact your nearest dealer or service centre. But, owner's manual and warranty are not sold additionally.

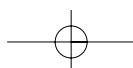

Connecting with TV

How to Connect with Audio/Video jack/Scart jack

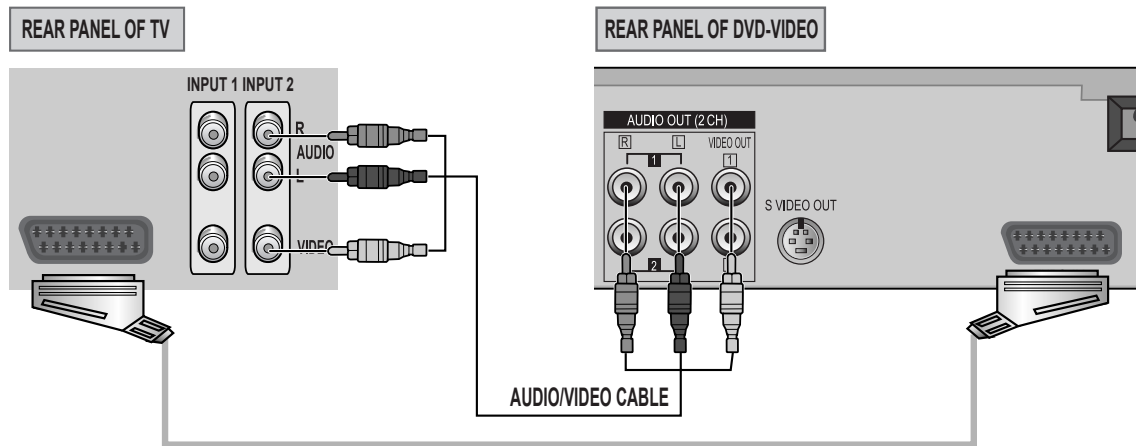

(If there is **AUDIO/VIDEO INPUT** jack in TV)

Connect **VIDEO OUT** jack in DVD player to **VIDEO IN** jack in TV, and **AUDIO OUT** jack in DVD player to **AUDIO IN** jack in TV with connecting cable of Audio/Video jack.

C H E C K U P !

- In/Out jack in Audio/Video terminal:
 - In: A jack used to receive signal required in this unit from other units.
 - Out: A jack used to send signal of this unit to other units.

Connecting with Stereo Unit

How to Connect with Stereo Unit such as Audio

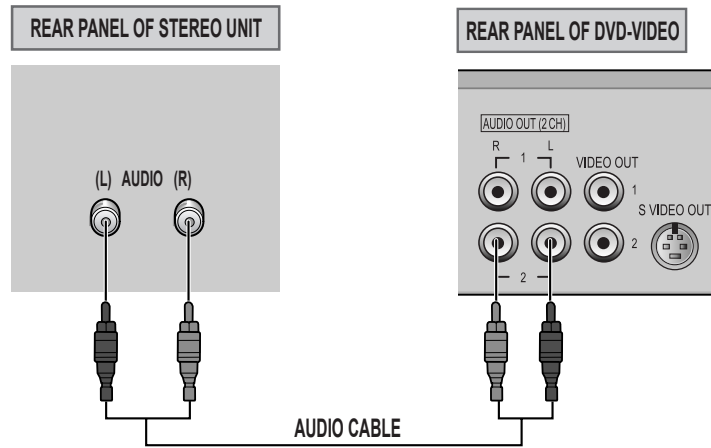

- 1** Connect Audio jack. Connect **AUDIO OUT** in rear panel of DVD player to **IN** jack of stereo sound unit.
- 2** For Input Select in stereo unit, Select "External Input" connected with DVD player.
- 3** Playback DVD disc, you can hear sound in speaker of stereo unit.

Connecting TV with S-Video, Dolby Digital Amp with Digital Audio Out Jack

■ Use in S-VIDEO or COMPONENT In jack attached in TV or amp supporting Dolby digital.

How to Connect

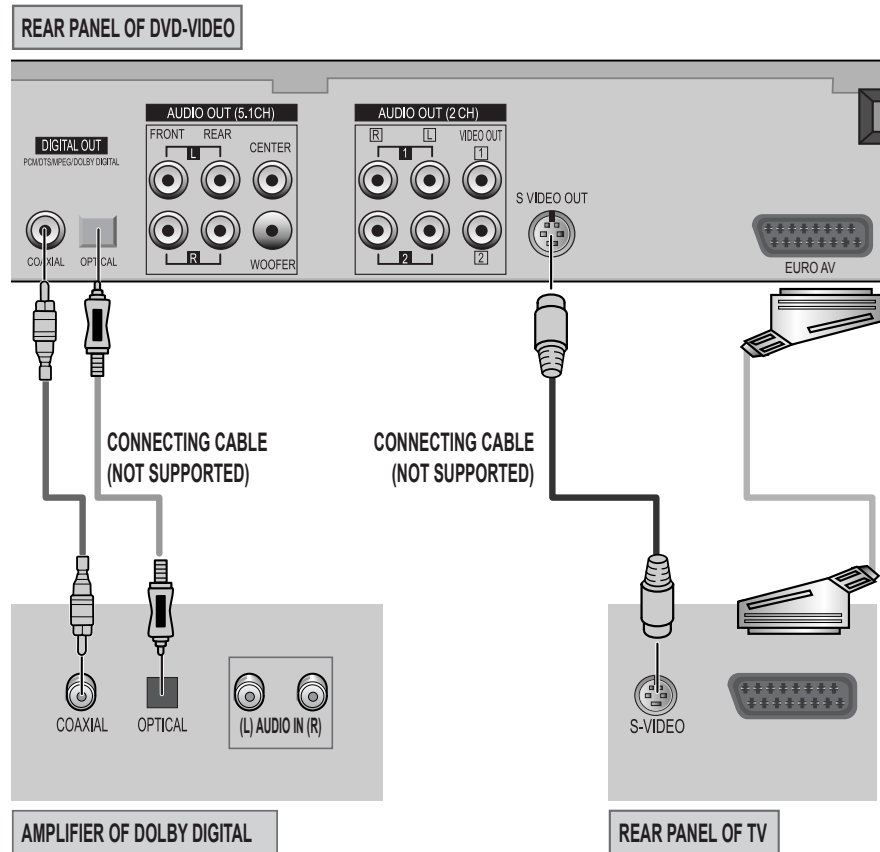

1 Select **S-VIDEO IN** to connect to TV. You should select "Video Out" type in DVD SET in advance.

2 Select either COAXIAL or OPTICAL to connect to amp of Dolby digital.

** If you want to know about "Dolby digital", please refer to [About DVD] on page 44.

Language	Video	Audio	Speaker	Others
TV Aspect	4:3 PS			
TV Type	NTSC			
Video Out	S-Video	RGB		
Brightness	Dark	S-Video		
Sharpness	Normal			

Move: ▲▼ Select: ◀▶ Exit:Setup/Return

Connecting with Amplifier Having 5.1 Channel Analog Terminals

- Apply this section just to an amplifier without digital audio input terminals.
Only when playing DVD disc, it is available of output.

How To Connect

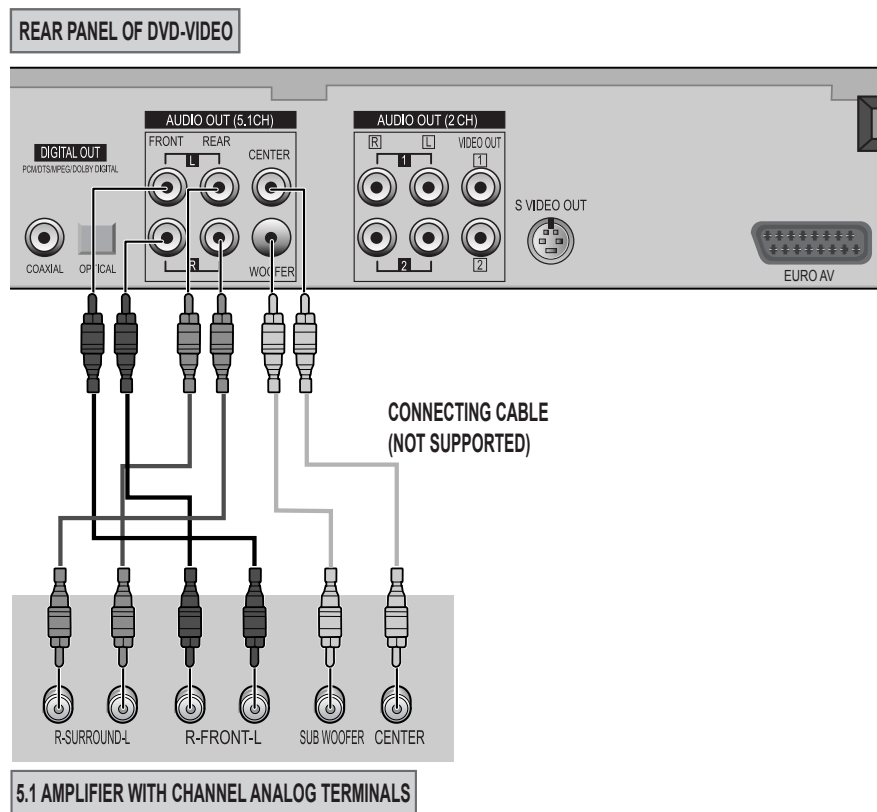

1 Since more than three speakers are connected, above all, set the Speaker item in DVD SET. (See page 35~36)

2 You can connect a maximum of six speakers.

** For more information on "Dolby Digital 5.1 Channel", see [About DVD] on page 44.

Language	Video	Audio	Speaker	Others
Downmix	Lt/Rt	Lt/Rt	Lt/Rt	
Centre	On	Lo/Ro	Off	
Rear	On	On	Off	
Subwoofer	On	On	On	
Centre Delay	On	On	On	
Rear Delay	On	On	On	

Move: ▲ ▼ Select: ◀ ▶ Exit: Setup/Return

DVD Playback

1 Press [ STANDBY] button to power on.

2 Press [OPEN/CLOSE] button to open the disc tray.
Place a disc firmly on the disc tray, making its label look upward.

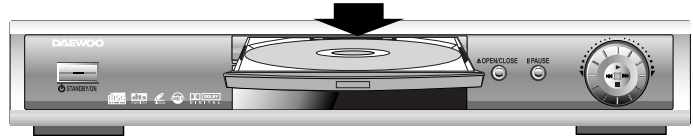

3 Insert the disc and press [OPEN/CLOSE] button to close the tray.
The disc tray is closed and after checking the disc's condition, Playback or Stop function starts to operate.

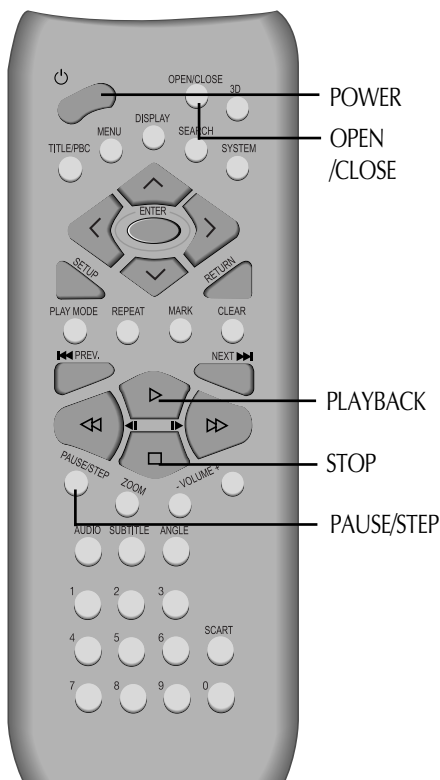

4 To playback it, press [ PLAY] button.

- In the case of DVD, DVD menus and titles are displayed on TV screen.
- In the case of S-VCD and VCD2.0 the menus are displayed on TV screen and it is converted into PBC(Playback Back Control) mode.
- In the case of CD, VCD1.1 and MP3, the disc plays in order of its track numbers.

5 To stop it, press [] button.
For pause, press [PAUSE/STEP] button.
If you press this button once more, it makes playback advance frame by frame.

6 Press [OPEN/CLOSE] button to remove the disc.

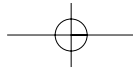

Various Playback Methods

■ If you want fast playback,

press [▶▶] button in Playback mode.
You can watch fast playing screen.

■ If you want fast rewinding playback,

press [◀◀] button in Playback mode.
You can watch fast rewinding screen.

■ If you want still picture,

press [PAUSE/STEP] in Playback mode.
You can watch the desired screen in stop status.

■ If you want slow-motion playback,

press [▶▶] or [◀◀] button in Pause mode.
You can watch the desired screen in the forward or backward direction.

■ If you want to watch a series of screens one by one (FRAME ADVANCE)

press [PAUSE/STEP] button or rotate Jog Ring in Pause mode.
Each time you press this button, the picture advances one frame.

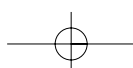
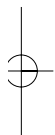

Skipping from a current scene to a desired scene

To skip scenes in a DVD

DVD

1 To move to next scene, press [NEXT] button.
The current scene moves to the next scene.

2 Press [PREV] button.
The current scene moves to the first scene.
If pressing it again, it moves to the prior scene.

To play it fast

DVD

VCD

1 Press [▶▶] button to start fast-play in playing.
Every time you press the button, play speed changes in the below orders
▶▶ x 2 → ▶▶ x 4 → ▶▶ x 8 → ▶▶ x 20 → ▶▶ x 2 ...
Also you can return to normal speed by pressing [▶] button.

2 Press [◀◀] button to start reverse fast-play in playing.
Every time you press the button, reverse play speed changes in the below orders
◀◀ x 2 → ◀◀ x 4 → ◀◀ x 8 → ◀◀ x 20 → ◀◀ x 2 ...
Also you can return to normal speed by pressing [▶] button.

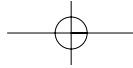

To play it slow

DVD

VCD

1 Press [▶▶] button to play it slow in PAUSE.

Every time you press the button, slow play speed changes in the below orders.

▶▶ 1/2 → ▶▶ 1/4 → ▶▶ 1/8 → ▶▶ 1/2 →

Also you can return to normal speed by pressing [▶] button.

2 Press [◀◀] button to reverse-play it slow in PAUSE.

Every time you press the button, slow reverse-play speed changes in the below orders.

◀◀ 1/2 → ◀◀ 1/4 → ◀◀ 1/8 → ◀◀ 1/2 →

Also you can return to normal speed by pressing [▶] button.

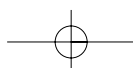

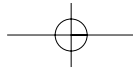

Playing a programmed order



■ Available only in STOP.

1 While STOP or Memorise STOP, press [PLAY MODE] button.

While the right figure is appearing, please input desired Title(T) and Chapter(C) number with NUMBER buttons.

* In case of VCD and CD, please input TRACK Number.

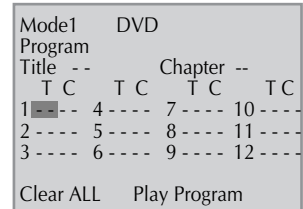

2 After completing setting, press [ENTER] button after moving a cursor to PLAY. Then, titles and chapters (track) are played in the above-programmed order.

* To exit from Program mode, press the STOP button.

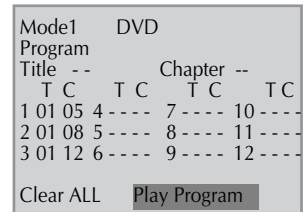

RANDOM PLAY



1 While STOP or Memorise STOP, press [PLAY MODE] button twice.

With the right picture appearing, please press [ENTER] button. Regardless of titles or track numbers, it plays in random.

* To exit from Shuffle mode, press the STOP button.

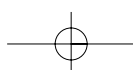
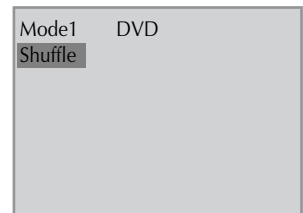

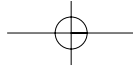

Repeating a Chapter or Title (DVD)

You may repeat a desired chapter or title.

DVD

1

While playing, press [PLAY MODE] button.

If the right figure appears, press [ENTER] button.
Then, the current chapter is repeated.

```
Mode1 DVD
Repeat
Chapter Title Off
```

2

Press [PLAY MODE] button again.

Move a cursor to "Title" with [>] button, then if the right figure appears, press [ENTER] button.
Then, the current title is repeated.

```
Mode1 DVD
Repeat
Chapter Title Off
```

NOTE

- A certain disc may not be repeated.

3

Press [REPEAT] button one more time.

Move a cursor to "Off" with [>] button, then if the right figure appears, press [ENTER] button.
REPEAT mode is off.

```
Mode1 DVD
Repeat
Chapter Title Off
```

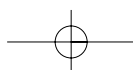

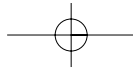

Repeating a Track or Disc (VCD, CD)



1 While playing, press [PLAY MODE] button.
 If the right figure appears, press [ENTER] button.
 Then, the current track is repeated.

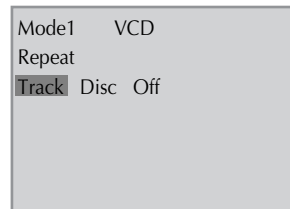

2 Press [PLAY MODE] button again.
 Move a cursor to "Disc" with [>] button, then if the right figure appears, press [ENTER] button.
 Then, the current disc is repeated.

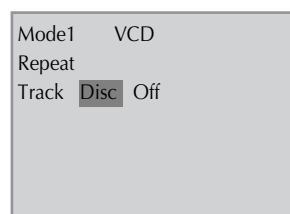

3 Press [PLAY MODE] button one more time.
 Move a cursor to "Off" with [>] button, then if the right figure appears, press [ENTER] button.
 REPEAT mode is off.

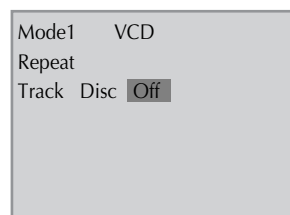

Repeating a defined period from A to B (DVD, VCD, CD)

You may repeat a defined period from A to B.



At the point where you want to start the repeat playback, press [REPEAT] button.
 The right figure appears and repeat playback start position (A) is set.

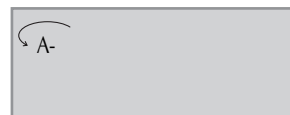

NOTE

- A MP3 disc may not be repeated from A to B.

At the point where you want to end the repeat playback, press [REPEAT] button again.
 The repeat playback end position (B) is set and a defined period from A to B is playback repeatedly.

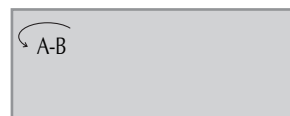

* To exit from repeat playback mode, press [REPEAT] button.
 It enters into Normal Playback mode.

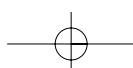
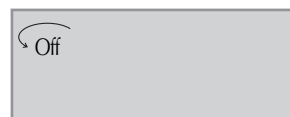

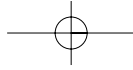

SEARCH DVD (with a title or chapter number)

DVD

- While playing, press [SEARCH] button.**
 "SEARCH 1" screen like the right figure appears.
 It shows total title numbers and chapter numbers.
 Please enter the new title and chapter number to be searched using the [NUMBER] buttons.

```
Search1   DVD
Title --- 1-2 Chapter --- 1-8
```

- In completing entering, please press [ENTER] button.**
 PLAY starts from the selected position.

```
Search1   DVD
Title --- 1-2 Chapter 006 1-8
```

SEARCH DVD (with time)

DVD

- While in playing, press [SEARCH] button twice.**
 "SEARCH 2" screen like the right figure appears.
 It shows total time.
 Please enter the new time to be searched using the [NUMBER] buttons.

```
Search2   DVD
Time --- : --- : --- 02:03:25
```

- In completing entering, please press [ENTER] button.**
 PLAY starts from the selected position.

```
Search2   DVD
Time 01:00:00 02:03:25
```

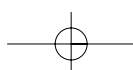

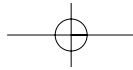

SEARCH VCD and CD (with a track number)

VCD

CD

1

While in playing, press [SEARCH] button.

"SEARCH 1" screen like the right figure appears.

(In case of PBC OFF)

Total track numbers appear.

Please enter the new track numbers to be searched using the [NUMBER] button.

* If it is PBC ON, "SEARCH 1" screen does not appear.

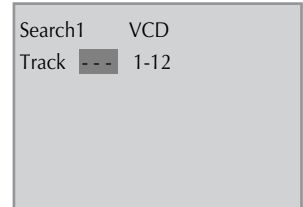

2

In completing entering, please press [ENTER].

PLAY starts from the selected position.

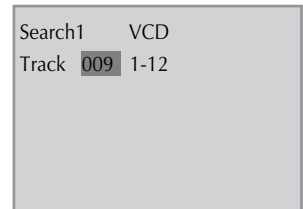

SEARCH VCD and CD (with time)

VCD

CD

1

While in playing, press [SEARCH] button twice.

"SEARCH 2" screen like the right figure appears.

(In case of PBC OFF)

It shows current track's time and the whole disc's hours.

Please enter the new time to be searched using the [NUMBER] button.

* If it is PBC OFF, only the track's time appears.

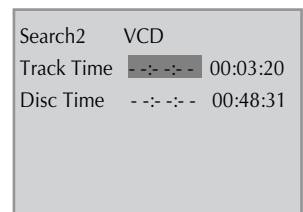

2

In completing entering, please press [ENTER] button.

PLAY starts from the selected position.

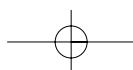
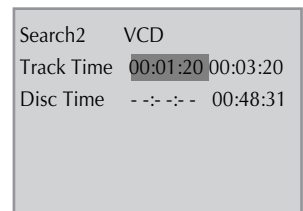

Confirming the current PLAY mode on screen

Confirming the current DVD disc mode

DVD

1 While in playing, press [DISPLAY] button.
It shows the time elapsed.



2 While in playing, press [DISPLAY] button.
It shows the disc type, time elapsed, total time, the current title, the current chapter, angle mode, audio selected and subtitle selected.



Confirming the current VCD, CD disc mode

VCD

CD

1 While in playing, press [DISPLAY] button.
It shows the time elapsed.



2 While in playing, press [DISPLAY] button.
It shows the disc type, time elapsed, total time, the current track and PBC on/off.

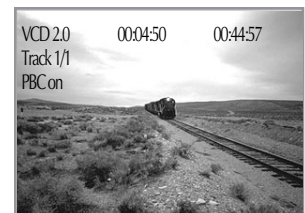

Selecting an AUDIO language, SUBTITLE language and 3D AUDIO

Selecting an audio language

The user may select an audio language and subtitle language if a disc includes Multi-language.

DVD

Keep pressing [AUDIO] button till the user's preferred language appears.

If DVD disc includes audio information, every time the user presses [AUDIO] button, English (ENG), French (FRE), Japanese (JAP), Korean (KOR) and others appear one by one.

Audio 1/3 6Ch ENG

Selecting a subtitle language

DVD

NOTE

- A certain disc may not support audio select or subtitle select.

Keep pressing [SUBTITLE] button till the user's preferred language appears.

If a DVD disc includes subtitle information, every time the user presses [SUBTITLE] button, English (ENG), French (FRE), Japanese (JAP), Korean (KOR) and others appear one by one. If a user presses [OFF] button, subtitle does not appear on screen.

Subtitle 1/3 ENG

Selecting 3D Audio

DVD

VCD

CD

- Available in PLAY mode only.

Please press [3D] button.

If pressing the button twice, the user can select a 3D audio.

3D on

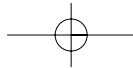

Selecting ZOOM and Multi Angle

Using a zoom function

The user can enlarge the current screen about 1.3, 1.5 or 2.0 times.

DVD

Keep pressing [ZOOM] button till the preferred zoom appears.

Every time the user presses [ZOOM] button, a zoom magnification changes 1.3 times (X1.3) → 1.5 times (X1.5) → 2.0 times (X2.0) → OFF → 1.3 times (X1.3) → ... one by one.

A base point to be enlarged is centre and the point can be changed with the operation of [**<** **>** **^** **v**] button.



Different Angle

If a disc includes multi angle information, the user can watch a screen in multi angles. The function is limited to a DVD disc supporting multi angle information.

DVD

Keep pressing [ANGLE] button till the preferred angle appears.

Every time the user presses [ANGLE] button, an angle degrees changes in a consecutive order.

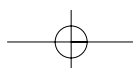
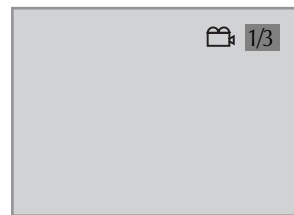

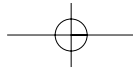

Memorizing a scene

Once memorizing a scene, the user may watch it anytime.

To memorize a scene

DVD

VCD

1

While playing, press [MARK] button.

The right figure appears.
Then press [ENTER] button and the current scene is memorized in "A".

Bookmark DVD
A---:-- B---:-- C---:--

2

If you want to memorize another preferred scene, press [>] button.

The right figure appears.
Then press [ENTER] button and the current scene is memorized in "B".

Bookmark DVD
A01:30:10 B---:-- C---:--

** The user may memorise "C" continuously with the same method.

Playing a memorised scene

DVD

VCD

1

Press [MARK] button.

Memorised bookmark appears on screen.

Bookmark DVD
A01:30:10 B01:40:00 C---:--

2

Move it to preferred bookmark by pressing [>] button.

 moves to the bookmark position.
In the moment, press [ENTER] button to play it.

Bookmark DVD
A01:30:10 B01:40:00 C---:--

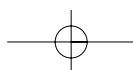

Displaying menus in a disc

If a disc includes menus, the user may use them.

To display menus in a disc

DVD

VCD2.0

1 Press [MENU] button.

- In case of a DVD disc, it shows menus in the disc. Also they are different according to discs
- If it is a VCD2.0, every time pressing [MENU] button, PBC light turns ON and OFF over and over.
- CD and VCD1.1 do not support the function.

2 If it is a DVD disc, move a cursor to a relative item with arrow buttons of [**<** **>** **^** **v**] button and select one with [ENTER] button or [PLAY] button.

Basic SETUP mode

While DISC STOP or Memorise STOP, press [SETUP] button to set menus.

1 While a disc is stopped, press [SETUP] button.

- A screen to set various menus like the right figure appears.
- By using [<] and [>], a set menu changes from LANGUAGE, which is covered with "█", to VIDEO, AUDIO, SPEAKER and OTHERS.
- If "█" is on LANGUAGE, press [<] or [>] to display submenus
- Press [^] and [v] for the movement among menus and press [<] and [>] for the select of a menu.

Language	Video	Audio	Speaker	Others
OSD Language		English		
Audio		English		
Subtitle		English		
Disc Menu		English		

Move: ◀ ▶ ▼ Exit: Setup/Return

Language	Video	Audio	Speaker	Others
TV Aspect		4:3 PS		
TV Type		NTSC		
Video Out		S-Video		
Brightness		Dark		
Sharpness		Normal		

Move: ◀ ▶ ▼ Exit: Setup/Return

Language	Video	Audio	Speaker	Others
Digital Out		Bitstream		
Dual Mono		Stereo		
Dynamic Range		Off		

Move: ◀ ▶ ▼ Exit: Setup/Return

Language	Video	Audio	Speaker	Others
Downmix		Lt/Rt		
Centre		On		
Rear		On		
Subwoofer		On		
Centre Delay		On		
Rear Delay		On		

Move: ◀ ▶ ▼ Exit: Setup/Return

Language	Video	Audio	Speaker	Others
OSD		On		
Angle Mark		On		
Screensaver		On		
Defaults		Reset		
Password		----		
Parental		8 Unlock		

Move: ◀ ▶ ▼ Exit: Setup/Return

2

In completing settings, press [RETURN] button or [SETUP] button.

LANGUAGE Setup

The user can set the language of menus in a disc, audio and subtitle.

1 While DISC STOP or Memorise STOP, press [SETUP] button.

Language	Video	Audio	Speaker	Others
OSD Language		English		
Audio		English		
Subtitle		English		
Disc Menu		English		

Move: ◀ ▶ ▼ Exit: Setup/Return

2 Selecting a language on screen. Please select a language to be displayed on DVD screen.

Language	Video	Audio	Speaker	Others
OSD Language		English	English	
Audio		English	French	
Subtitle		English	Spanish	
Disc Menu		English		

Move: ▲ ▼ Select: ◀ ▶ Exit: Setup/Return

3 Selecting an audio language. Set it as the preferred audio language. In case the audio language is set and recorded in the DISC, it is automatically played in the set language everytime it is placed. For example, English is set and recorded as audio language in the DISC, it is played in English.

Language	Video	Audio	Speaker	Others
OSD Language		English	English	
Audio		English	French	
Subtitle		English	Spanish	
Disc Menu		English	Portuguese	Chinese

Move: ▲ ▼ Select: ◀ ▶ Exit: Setup/Return

4 Selecting a subtitle language. Please set it as the preferred language. In case the subtitle language is set and recorded in the DISC, it is automatically played in the set language everytime it is placed. For example, English is set and recorded as subtitle language in the DISC, it is played in English.

Language	Video	Audio	Speaker	Others
OSD Language		English	English	
Audio		English	French	
Subtitle		English	Spanish	
Disc Menu		English	Portuguese	Chinese

Move: ▲ ▼ Select: ◀ ▶ Exit: Setup/Return

NOTE

- In case a disc does not include setting languages information, the selected language does not appear.

5 Selecting a DISC MENU language. Please set it as the preferred DISC MENU language. In case the DISC MENU language is set and recorded in the DISC, it is automatically played in the set language everytime it is placed. For example, English is set and recorded as a DISC MENU language in the DISC, it is played in English.

Language	Video	Audio	Speaker	Others
OSD Language		English	English	
Audio		English	French	
Subtitle		English	Spanish	
Disc Menu		English	Portuguese	Chinese

Move: ▲ ▼ Select: ◀ ▶ Exit: Setup/Return

VIDEO Setup

A user can set up a connected TV condition and screen.

1 While DISC STOP or Memorise STOP, press [SETUP] button.

Language	Video	Audio	Speaker	Others
TV Aspect	4:3 PS			
TV Type	NTSC			
Video Out	S-Video			
Brightness	Dark			
Sharpness	Normal			
Move: ◀ ▶ ▼ ▲				Exit:Setup/Return

2 Selecting TV Aspect.

If a user selects "4:3 PS", the user can watch only a centre of the original scene of "16:9".

If a user selects "4:3 LB", the user can watch the original scene of "16:9", but the top and bottom of the screen look black color.

If a disc size is originally recorded in 4:3, the user cannot watch it in a wide screen though the user sets a size as "16:9 Wide".

Language	Video	Audio	Speaker	Others
TV Aspect	4:3 PS	4:3 PS		
TV Type	NTSC	4:3 LB		
Video Out	S-Video	16:9 Wide		
Brightness	Dark			
Sharpness	Normal			
Move: ▲ ▼ Select: ◀ ▶				Exit:Setup/Return

3 Selecting a TV type.

The user may select a TV type.

The user may select a type among NTSC, PAL or AUTO.

Language	Video	Audio	Speaker	Others
TV Aspect	4:3 PS	Auto		
TV Type	NTSC	NTSC		
Video Out	S-Video	PAL		
Brightness	Dark			
Sharpness	Normal			
Move: ▲ ▼ Select: ◀ ▶				Exit:Setup/Return

4 Selecting a VIDEO OUTPUT.

The user may select a VIDEO OUTPUT between COMPONENT and S-VIDEO.

*"Composite Video Out" is always available.

Language	Video	Audio	Speaker	Others
TV Aspect	4:3 PS			
TV Type	NTSC			
Video Out	S-Video	RGB		
Brightness	Dark	S-Video		
Sharpness	Normal			
Move: ▲ ▼ Select: ◀ ▶				Exit:Setup/Return

5 Selecting a bright degree.

The user may select a bright degree of a screen.

There are two choices of DARK and BRIGHT.

Language	Video	Audio	Speaker	Others
TV Aspect	4:3 PS			
TV Type	NTSC			
Video Out	S-Video			
Brightness	Dark	Dark		
Sharpness	Normal	Bright		
Move: ▲ ▼ Select: ◀ ▶				Exit:Setup/Return

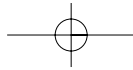

6

Selecting a vivid degree.

A user may select a vivid degree of a screen. There are three of choices, NORMAL, SOFT and SHARPEN.

Language	Video	Audio	Speaker	Others
TV Aspect	4:3 PS			
TV Type	NTSC			
Video Out	S-Video			
Brightness	Dark		Normal	
Sharpness	Normal		Soft	
			Sharp	

Move: ▲▼ Select : ◀▶ Exit:Setup/Return

AUDIO Setup

A user may select audio menu according to a user's speaker set.

1 While DISC STOP or Memorise STOP, press [SETUP] button.



2 Select a digital output.

Set output conditions to coaxial or optical terminal. You can set following three(3) values of digital output;

- OFF: Not any output goes to digital audio output terminal.
- BITSTREAM: The same signal as audio signal recorded in disc goes to digital audio output terminal.
- PCM: Decoded audio signal goes to digital output terminal.

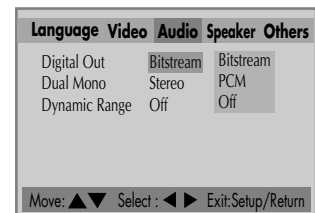

3 Select Dual Mono.

Dual Mono means 2 individual mono channels. Dual Mono is mainly used to apply 2 different languages to one program. This function is similar to multichannel sound function supported in TV or VCR. 2 mono channels can be combined into total 4 values; STEREO, LEFT MONO, RIGHT MONO and MIXED MONO.

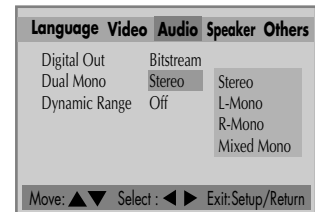

- STEREO: outputs left channel and right channel to left speaker and right speaker respectively.
- LEFT MONO: outputs left channel to left speaker and right speaker.
- RIGHT MONO: outputs right channel to left speaker and right speaker.
- MIXED MONO: mixes 2 mono channels and outputs the mixed channel to left and right speaker at the same time.

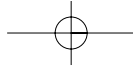

4

Select a Dynamic Range.

Dynamic range can differ by users and their watching environment. High-density audio programs like movies have wide dynamic range. In the dynamic range, explosion sounds 20dB higher and rustle of leaves sounds 50dB less than conversation. Sometimes, depending on watching environment, loud sound should be heard louder while soft sound should be heard softer. Likewise, very soft sound is not audible and viewers should raise the sound level.

Set "OFF" to view a program in the dynamic range as recorded in disc. If you hear loud sound softer and soft sound louder, set a suitable value below "MAX".



SPEAKER Setup

A user may set each speakers sound.

■ 5.1 CH Analogue Amplifier only.

1 While DISC STOP or Memorise STOP, press [SETUP] button.

Language	Video	Audio	Speaker	Others
Downmix	Lt/Rt			
Centre	On			
Rear	On			
Subwoofer	On			
Centre Delay	On			
Rear Delay	On			
Move: ◀ ▶ ▼				Exit:Setup/Return

2 Select a DOWN MIX.

- If Lt/Rt or Lo/Ro is selected, a menu cannot move to the below 3 to 7 menus.

Language	Video	Audio	Speaker	Others
Downmix	Lt/Rt	Lt/Rt		
Centre	On	Lo/Ro		
Rear	On	Off		
Subwoofer	On			
Centre Delay	On			
Rear Delay	On			
Move: ▲ ▼ Select: ▶ ◀				Exit:Setup/Return

DOWNMIX is used to reproduce the proper analog audio when the audio channel recorded on the disc differs from the output audio channel configuration. Assume that 5.1 channels audio are recorded on the disc but you can receive only stereo audio channels. In this case downmix is unavoidable and you will hear all the channels recorded on disc.

3 Select a CENTRE speaker.

This submenu is valid when you are using an amplifier, which have the 5.1 channel analog audio input. If you have the centre speaker, please turn the sub item ON. If not, turn OFF. If you are going to adjust the centre delay, please turn the sub item ON. If not, you can't adjust the centre delay.

Language	Video	Audio	Speaker	Others
Downmix	Lt/Rt			
Centre	On	On		
Rear	On	Off		
Subwoofer	On			
Centre Delay	On			
Rear Delay	On			
Move: ▲ ▼ Select: ▶ ◀				Exit:Setup/Return

4 Select a REAR speaker.

This submenu is valid when you are using an amplifier, which have the 5.1 channel analog audio input. If you have the rear speaker, please turn the sub item ON. If not, turn OFF. If you are going to adjust the rear delay, please turn the sub item ON. If not, you can't adjust the rear delay.

Language	Video	Audio	Speaker	Others
Downmix	Lt/Rt			
Centre	On			
Rear	On	On		
Subwoofer	On	Off		
Centre Delay	On			
Rear Delay	On			
Move: ▲ ▼ Select: ▶ ◀				Exit:Setup/Return

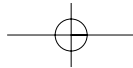

5

Select SUBWOOFER.

This submenu is valid when you are using an amplifier, which have the 5.1 channel analog audio input. If you have the subwoofer speaker, please turn the sub item ON. If not, turn OFF.

Language	Video	Audio	Speaker	Others
Downmix	Lt/Rt			
Centre	On			
Rear	On			
Subwoofer	On		On	
Centre Delay	On		Off	
Rear Delay	On			

Move: ▲▼ Select: ◀▶ Exit:Setup/Return

6

Select a time DELAY of a CENTRE speaker.

You can adjust the sound in home by adding delay time to the centre speaker. See REAR DELAY for more information.

Language	Video	Audio	Speaker	Others
Downmix	Lt/Rt		Off	
Centre	On		1ms	
Rear	On		2ms	
Subwoofer	On		3ms	
Centre Delay	On		4ms	
Rear Delay	On		5ms	

Move: ▲▼ Select: ◀▶ Exit:Setup/Return

7

Select a time DELAY of a REAR speaker.

Like CNTR DELAY, you can adjust the sound in home by adding delay time to the rear speaker. You may hear the best quality sound if the distance between speakers is same when playing 5.1 channel surround sounds. But the displacement of speakers with same distance is very difficult in real. Please refer the following figure and table, set the appropriate delay time.

Language	Video	Audio	Speaker	Others
Downmix	Lt/Rt		Off	
Centre	On		3ms	
Rear	On		6ms	
Subwoofer	On		9ms	
Centre Delay	On		12ms	
Rear Delay	On		15ms	

Move: ▲▼ Select: ◀▶ Exit:Setup/Return

	Df-Dc (cm)	Value (ms)
	Df<=Dc	OFF
Centre Speaker Delay	34	1
	68	2
	102	3
	136	4
	170	5

	Df-Ds(cm)	Value (ms)
	Df<=Ds	OFF
Rear Speaker Delay	102	3
	204	6
	306	9
	408	12
	510	15

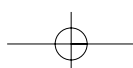
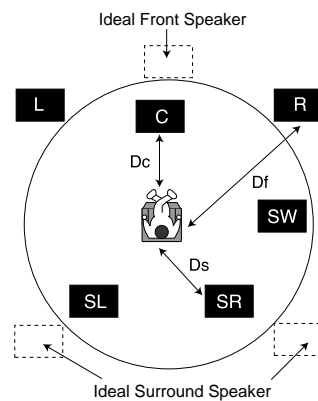

Other Setup

- 1** While DISC STOP or Memorise STOP, press [SETUP] button.

Language	Video	Audio	Speaker	Others
OSD	On			
Angle Mark	On			
Screensaver	On			
Defaults	Reset			
Password	----			
Parental	🔒	8	Unlock	
Move: ◀ ▶ ▼ ▲ Exit: Setup/Return				

- 2** Select character display window.
Select "ON" to make OSD(On Screen Display) language displayed in screen.

Language	Video	Audio	Speaker	Others
OSD	On	On		
Angle Mark	On	Off		
Screensaver	On			
Defaults	Reset			
Password	----			
Parental	🔒	8	Unlock	
Move: ▲ ▼ Select: ▶ ◀ Exit: Setup/Return				

- 3** Select angle mark.
Different angle screens up to 9 screens can be saved in DVD. You can set with this menu whether angle mark (⌂) is displayed in the screen during playing the multiple-angle-recorded disc. Select "ON", the angle mark (⌂) is displayed in the screen if multiple angles are recorded in the currently played disc.

Language	Video	Audio	Speaker	Others
OSD	On	On		
Angle Mark	On	Off		
Screensaver	On			
Defaults	Reset			
Password	----			
Parental	🔒	8	Unlock	
Move: ▲ ▼ Select: ▶ ◀ Exit: Setup/Return				

- 4** Select screen save.
If bright scenes continue to be displayed in screen, TV can be damaged. Set the screensaver to "ON", the screensaver functions automatically and DVD logo moves continuously if the screen does not operate for about 5 minutes.

Language	Video	Audio	Speaker	Others
OSD	On	On		
Angle Mark	On	Off		
Screensaver	On	On		
Defaults	Reset			
Password	----			
Parental	🔒	8	Unlock	
Move: ▲ ▼ Select: ▶ ◀ Exit: Setup/Return				

- 5** Select defaults.
If you select defaults, every function set returns to FACTORY OUT SET except PARENTAL.

Language	Video	Audio	Speaker	Others
OSD	On	On		
Angle Mark	On	Off		
Screensaver	On	On		
Defaults	Reset			
Password	----			
Parental	🔒	8	Unlock	
Move: ▲ ▼ Select: ▶ ◀ Exit: Setup/Return				

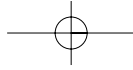

6

Entering a password.

Input password display appears.

Enter a user's password by pressing 4 [Number] button.



7

Select PARENTAL.

It consists of 8 levels of parental control, violence, sexual scene, strong sexual scene and others to protect children from watching those scenes.

About DVD



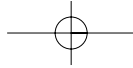

Playable Disc

- DVD, Video CD (Version 1.1, 2.0), S-VCD and Audio CD

Disc type	Playable	Restriction
DVD	Possible	Region number 3 or No region number
Video CD	Possible	Version 1.0/1.1/2.0, SVCD/CVD
CD	Possible	PCM or dts
CD-G	Possible	Only Audio playback (No graphics!)
CD-ROM	Possible	MP3 File, 200 Files in maximum
CD-R	Possible	Video-CD/CD/CD-ROM (MP3 File)
CD-RW	Possible	Video-CD/CD/CD-ROM (MP3 File)
DVD-ROM	Impossible	
DVD-R	Possible	DVD Video
DVD-RAM	Impossible	
DVD+RW	Impossible	
Photo CD	Impossible	

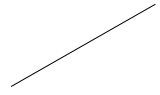

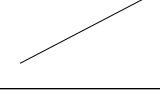
Disc Information

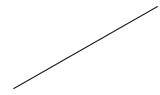
Type	Mark	Contents	Size	Playback time
DVD		Audio+Video signals (Video clips)	12cm	2hrs (single side)
				8hrs (both sides)
			8cm	80mins (single side)
				160mins (both sides)
S-VCD		Audio+Video signals (Video clips)	12cm	45min
VCD		Audio+Video signals (Video clips)	12cm	74min
			8cm	20min
CD		Audio signals	12cm	74min
			8cm	20min
MP3		Audio signals	12cm	160min
CD-R		Audio signals	12cm	600min
CD-RW		Audio signals	12cm	600min

REGION MANAGEMENT INFORMATION

This unit is designed and manufactured to respond to the Region Management information that is recorded on a DVD disc. The region number of this player is "2". If the region number described on the DVD discs does not correspond to the Region number of this player, the player will not play this disc. This player will play DVD discs made for "ALL" regions. Therefore, this player will play DVD discs marked with labels containing the region number "2" or "ALL".



(Region 2)



(Region ALL)

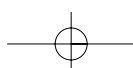

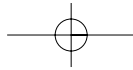

Terms related with DVD

- DVD** A DVD (abbreviation of Digital Versatile Disc or Digital Video Disc) can include 135 minutes of video information. And for audio, it can hold up to 8 kinds of languages and 32 kinds of subtitle languages. By using MPEG-2 video compression and digital 3D surround sound, DVD realizes high-defined screen and quality sound like a movie theater.
- CDDA** A CDDA (abbreviation of Compact disc digital audio) is a music disc that is currently used.
- MP3** MP3 (abbreviation of MPEG-1 Audio Layer 3) sizes up with a small file and supports CD quality sound.
- PBC** By creating menus in a simple video CD, it enables a user to communicate with a CD. Also PBC is adopted in VCD2.0, SVCD and CVD.
- CHAPTER** It means the information recorded in a DVD. A title in a DVD is divided into many tracks, of which a track is called as a chapter. A certain scene of a screen can be quickly searched with the chapter number.
- TITLE** It means the information recorded in a DVD. A DVD can be divided into many titles.
- TRACK** It means the information recorded in a video CD and audio CD. A disc consists of many a track, for which a user can search a certain position.
- dts** dts (Digital Theatre System) is the standard of surround sound for 5.1 CH which are being widely adopted in films.
- Multi Angle** A certain DVD has scenes recorded in various angles. Also the disc is called as Multi Angle Disc.
- PCM** PCM (Pulse Code Modulation) means digital sound.
- Dolby digital** Dolby digital is a system maximized surround sound from the reform of the existing 4 CH PROLOGIC. Basically the system consists of 5 channels of a centre speaker, L & R speakers and L & R front main speakers. Dolby digital adds a sub-speaker to the above system in order to reinforce sub-woofer.
- Dolby digital 5.1 channel**
Dolby digital 5.1 CH is the system to output 5.1 CH analogue from decoding in DVD player itself and can be used with the connection of amplifier holding a 5.1 CH analogue terminal.
- Bitstream** Bitstream is the Dolby digital; or audio data to be decoded by dts decoder. Dolby digital or dts decoder embedded AMP is necessary for using Bitstream.

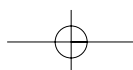

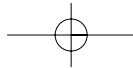

Lt/Rt It indicates L/R of Dolby Digital 2CH Downmix Output.

L/R/C/SW/LS/RS

6 channels are using in Dolby digital and dts. They are 3 channels for the front screen, 2 channels for surround and 1 subwoofer. The front left speaker is referred as L, right speaker as R, centre speaker as C, subwoofer as SW, left surround speaker as LS, right speaker as RS.

*L/R of 6CH output like upper case is displayed as Lo/Ro.

Downmix Downmix is the technology for playing proper audio in case the recorded audio channel construction and that of output channel does not match each other. Downmix will provide 5.1 channel-audio by using 2 stereo speakers.

S-VIDEO S-VIDEO offers clearer and sharper screen than COMPOSITE by separately-transmitting the signal of color(C) and brightness(Y).

Keeping a disc safety

- To keep a disc in clean condition, please do not touch the side containing play information.
- Do not attach a bit of paper or sticky tape on it.
- Do not expose a disc to a direct sunlight or electric heating systems.
- After using it, please keep the disc in a case.

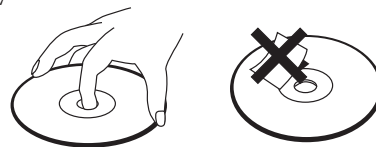

Cleaning a disc

- Please rub it from centre toward outside with clean clothes.
- Do not use thinner, benzol (benzene), commercial cleaning goods or antistatic sprays.

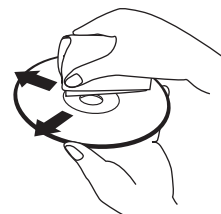

Macrovision

This product incorporates copyright protection technology that is protected by method claims of certain U.S patents and other intellectual property rights owned by Macrovision Corporation and other rights owners.

Use of this copyright protection technology must be authorized by Macrovision Corporation, and is intended for home and other limited viewing uses only unless otherwise authorized by Macrovision Corporation. Reverse engineering or disassembly is prohibited.

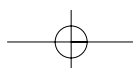

Before doubting about troubles

Symptom	Checks
<ul style="list-style-type: none"> • The recorder does not play. 	<ul style="list-style-type: none"> ▶ If a DVD is from overseas, it may not be played. Please check a DVD's region code whether it has the relative region code (2) or All. ▶ Please check whether a DVD is inserted in a right direction. ▶ CD-ROM, DVD-ROM isn't playback. (CD-ROM and DVD-ROM means the format which has simple information.)
<ul style="list-style-type: none"> • No sound comes through. 	<ul style="list-style-type: none"> ▶ Play mode may be "SLOW" or "PAUSE" (In abnormal speed play, no sound comes through) ▶ Did you press "MUTE"? ▶ Did you connect the parts in right way? ▶ Please check the operative condition of TV or amplifier. ▶ From "DEFAULT" SET, please check "AUDIO" and "SPEAKER" items.
<ul style="list-style-type: none"> • A disc is playing but screen does not appear or poor screen appears. 	<ul style="list-style-type: none"> ▶ Did you turn on your TV sets? ▶ Did you connect the parts in right way? ▶ The play may be in "PAUSE". ▶ A disc may have some contaminants or be damaged. ▶ A disc may be bad one.
<ul style="list-style-type: none"> • Sound is irregular. 	<ul style="list-style-type: none"> ▶ Please check the connection with Dolby digital amplifier. ▶ Please check the plugs are connected with one another tightly. ▶ Some contaminants may be remained in connection terminal.
<ul style="list-style-type: none"> • REMOTE does not work. 	<ul style="list-style-type: none"> ▶ Please check the degree of the REMOTE, distance or any interruption. ▶ Battery may be weak or exhausted.
<ul style="list-style-type: none"> • Dolby digital 5.1 CH 3D sound does not work. 	<ul style="list-style-type: none"> ▶ Dolby digital 5.1 CH 3D sound can be worked in the Dolby digital amplifier only. ▶ Please check "Dolby digital 5.1 CH" mark on your DVD. ▶ In case of playing it through digital output, while pressing "STOP", please check whether "DIGITAL OUTPUT" is "BITSTREAM" by pressing "SETUP". ▶ Please check the connection is correct.
<ul style="list-style-type: none"> • "AUDIO" or "SUBTITLE" button does not work. 	<ul style="list-style-type: none"> ▶ If a DVD does not include language information, it does not support the function.

Symptom	Checks
<ul style="list-style-type: none">• “ANGLE” button does not work while a DVD is playing.	<ul style="list-style-type: none">▶ “MULTI ANGLE” is supported only in a DVD contains multi angle scenes. Also a user can confirm the support with the “ANGLE” mark on screen.
<ul style="list-style-type: none">• “MENU” does not appear while a DVD is playing.	<ul style="list-style-type: none">▶ Please check the degree of the REMOTE, distance or any interruption.▶ Please check a battery in the REMOTE whether it is exhausted or not.▶ A DVD may not contain menu information.
<ul style="list-style-type: none">• Screen shakes or appears only in black and white.	<ul style="list-style-type: none">▶ The recorder may not coincide with your TV system. Please press “SYSTEM” to match to PAL system.▶ A disc may have some contaminants or be damaged.▶ Please check a DVD’s region code (2).

Specifications

Power	AC 110~220V 50/60Hz
Consumed electricity	15W (supplementary 5W)
Weight	4.25 kg
Dimension	430mmx65mmx250.3mm
Operative temperature	+5°C~35°C
Installation condition	Horizontal / Relative humidity under 80%
VIDEO output	VIDEO output terminal, 1Vp-p unbalanced, RCA JACK S-VIDEO output (75Ω In load Y: 1.0Vp-p, C:0.286Vp-p) Scart Jack
AUDIO output	Analogue Digital Optical Digital
	RCA JACK 2.5Vp-p 75Ω RCA JACK Optical Cable
AUDIO	90dB (EIA)
AUDIO dynamic range	90dB (EIA)

DVD Audio output standards

Output	Disc type		
	DVD	VIDEO-CD	CD
Analogue Audio output	48/96KHz sampling	44.1KHz sampling	44.1KHz sampling
5.1 CH (R/R, R/L, C/T, SW, F/R, F/L)	48KHz sampling	-	-
Digital Audio output	48KHz sampling	44.1KHz sampling	44.1KHz sampling
Optical digital audio output	48KHz sampling	44.1KHz sampling	44.1KHz sampling

Region Code

The product and all DVD disc have region codes. So if both codes are not coincided each other, it does not work. Legion codes are like the below.

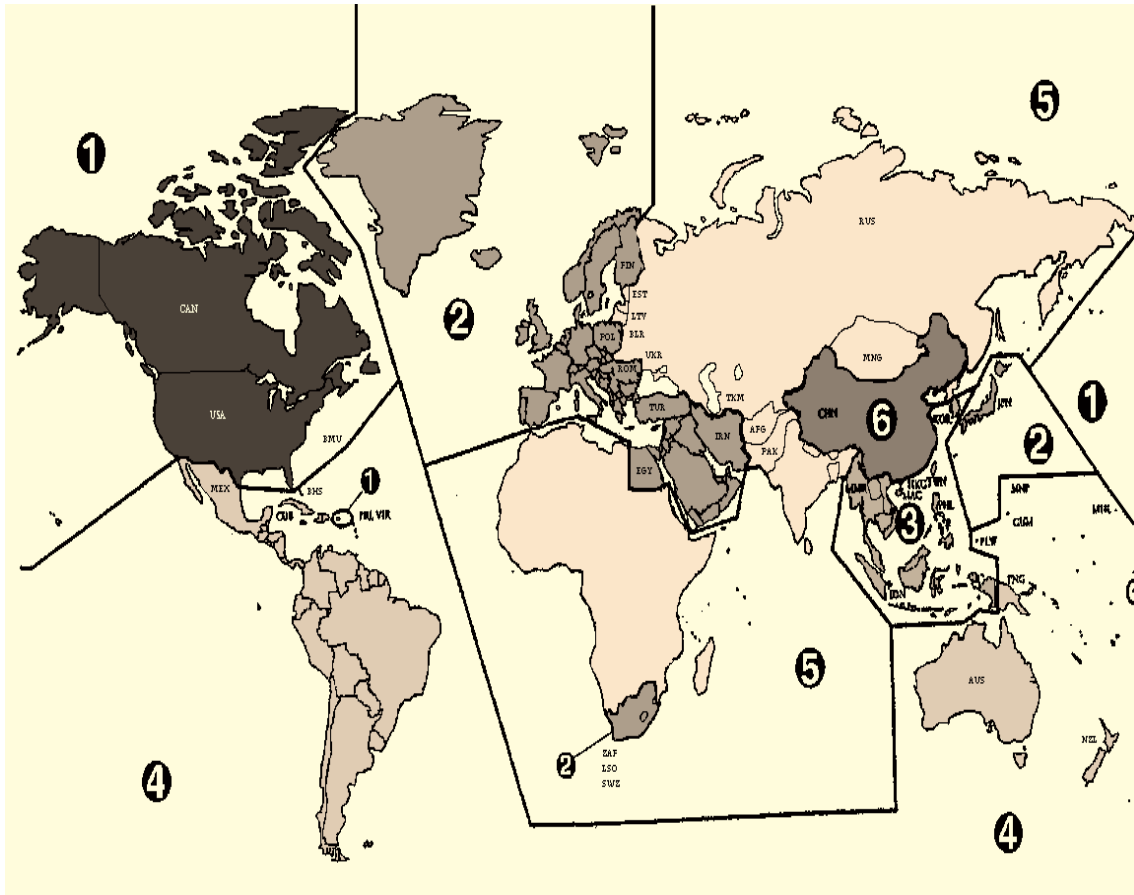

Free Manuals Download Website

<http://myh66.com>

<http://usermanuals.us>

<http://www.somanuals.com>

<http://www.4manuals.cc>

<http://www.manual-lib.com>

<http://www.404manual.com>

<http://www.luxmanual.com>

<http://aubethermostatmanual.com>

Golf course search by state

<http://golfingnear.com>

Email search by domain

<http://emailbydomain.com>

Auto manuals search

<http://auto.somanuals.com>

TV manuals search

<http://tv.somanuals.com>