

DAEWOO
ELECTRONICS



DVD Recorder + VCR

DF-4501P

User Manual

Safety Instructions

Please keep the product's guarantee sheet and receipt in a safe place.

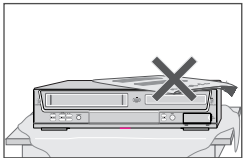
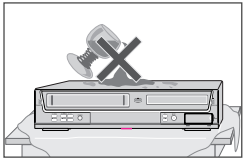
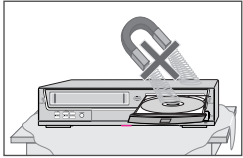
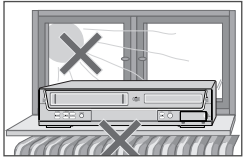



Precautions

- Read this booklet carefully.
- Make sure the rating of your household electricity supply matches that shown on the back of your product.
- Read this page and chapter 'Setting up your product' to help you set up and adjust your product correctly.
- Do not put the product in a hot or humid place.
- Do not open the product. Get a qualified technician to carry out any repairs.
- Do not connect the product to the power supply if you have just moved it from a cold environment to a warm room. This can lead to condensation inside the product, which can damage it. Wait for approx. 2 hrs for it to reach room temperature.
- Make sure the product is placed at least 10 cm apart from other home appliances or obstacles to ensure sufficient ventilation.
- The apparatus should not be exposed to dripping or splashing and no objects filled with liquids, such as vases should be placed on top of the recorder.
- Before a storm and/or lightning, unplug the product from the mains supply and aerial.
- Put the product on a steady flat surface.
- Only clean the product with a soft, lint-free cloth. Do not use harsh or alcohol-based cleaning agents.

For your own Safety



- There are no components in this product you can service or repair yourself.
- Do not open the case of the product. Only allow a qualified engineer to repair or service your product.
- This product is designed to work continuously. Switching it off (stand-by mode) does not disconnect it from the mains. To disconnect it from the mains you have to unplug it.

	CAUTION RISK OF ELECTRIC SHOCK DO NOT OPEN	
CAUTION: TO REDUCE THE RISK OF ELECTRIC SHOCK, DO NOT REMOVE COVER (OR BACK). NO USER-SERVICEABLE PARTS INSIDE. REFER SERVICING TO QUALIFIED SERVICE PERSONNEL.		

 The lightning flash with arrowhead symbol, within an equilateral triangle, is intended to alert the user to the presence of uninsulated 'dangerous voltage' within the product's enclosure that may be of sufficient magnitude to constitute a risk of electric shock.

 The exclamation point within an equilateral triangle is intended to alert the user to the presence of important operating and servicing instructions in the literature accompanying the appliance.

WARNING	TO REDUCE THE RISK OF FIRE OR ELECTRIC SHOCK, DO NOT EXPOSE THIS APPLIANCE TO RAIN OR MOISTURE.
CAUTION	TO PREVENT ELECTRIC SHOCK, MATCH WIDE BLADE OF PLUG TO WIDE SLOT, FULLY INSERT.

IMPORTANT FOR LASER PRODUCTS	
LASER	This Digital Video Disc Player employs a Laser System. To ensure proper use of this product please read this owner's manual carefully and retain for future reference. Should the unit require maintenance, contact an authorized service location - see service procedure. Use of control adjustments or the performance of procedures other than those specified may result in hazardous radiation exposure. To prevent direct exposure to the laser beam, do not try to open the enclosure. Visible laser radiation when open and interlocks defeated. DO NOT STARE INTO THE BEAM.
DANGER	Visible laser radiation when open and interlock failed or defeated. Avoid direct exposure to beam.
CAUTION	Do not open the top cover. There are no user serviceable parts inside the Unit; leave all servicing to qualified service personnel.
	

CAUTION	Any changes or modification in construction of this device which are not expressly approved by the party responsible for compliance could void the user's authority to operate the equipment.
----------------	---

This set has been designed and manufactured to assure personal safety. Improper use can result in electric shock or fire hazard. The safeguards incorporated in this unit will protect you if you observe the following procedures for installation, use and servicing. This unit is fully transistorized and does not contain any parts that can be repaired by the user.

- 1 READ INSTRUCTIONS**
All the safety and operating instructions should be read before the unit is operated.
- 2 RETAIN INSTRUCTIONS**
The safety and operating instructions should be retained for future reference.
- 3 HEED WARNINGS**
All warnings on the unit and in the operating instructions should be adhered to.
- 4 FOLLOW INSTRUCTIONS**
All operating and use instructions should be followed.
- 5 CLEANING**
Unplug this unit from the wall outlet before cleaning. Do not use liquid cleaners or aerosol cleaners. Use a damp cloth for cleaning.
- 6 ATTACHMENTS**
Do not use attachments unless recommended by the unit's manufacturer as they may cause hazards.
- 7 WATER AND MOISTURE**
Do not use this unit near water- for example, near a bath tub, wash bowl, kitchen sink or laundry tub, in a wet basement, or near a swimming pool.
- 8 ACCESSORIES**
Do not place this unit on an unstable cart, stand, tripod, bracket, or table. The unit may fall, causing serious injury to a child or adult as well as serious damage to the unit. Use this unit only with a cart, stand, tripod, bracket, or table recommended by the manufacturer.
- 8A** A unit and cart combination should be moved with care. Quick stops, excessive force, and uneven surfaces may cause the product and cart combination to overturn. PORTABLE CART WARNING (symbol provided by RETAC)
- 9 VENTILATION**
Slots and openings in the case are provided for



ventilation to ensure reliable operation of the unit and to protect it from overheating. These openings must not be blocked or covered. These openings must not be blocked by placing the unit on a bed, sofa, rug, or other similar surface. This unit should never be placed near or over a radiator or heat radiator. This unit should not be placed in a built-in installation such as a bookcase or rack unless proper ventilation is provided or the manufacturer's instructions have been adhered to.

- 10 POWER SOURCES**
This unit should be operated only from the type of power source indicated on the marking label. If you are not sure of the type of power supply to your home, consult your dealer or local power company. For units intended to operate from battery power, or other sources, refer to the operating instructions.
- 11 POWER-CORD PROTECTION**
Power-supply cords should be routed so that they are not likely to be walked on or pinched by items placed upon or against them, paying particular attention to cords at plugs, convenience receptacles, and the point where they exit from the unit.
- 12 LIGHTNING**
For added protection for this unit during a lightning storm, or when it is left unattended and unused for long periods of time, unplug it from the wall outlet and disconnect the antenna or cable system. This will prevent damage to the unit due to lightning and power line surges.
- 13 DISC TRAY**
Keep your fingers well clear of the disc as it is closing. It may cause serious personal injury.
- 14 OVERLOADING**
Do not overload wall outlets of extension cords as this can result in a risk of fire or electric shock.
- 15 OBJECT AND LIQUID ENTRY**
Never push objects of any kind into this unit through openings as they may touch dangerous voltage points or 'short-out' parts that could result in a fire or electric shock. Never spill liquid of any kind on the unit.
- 16 BURDEN**
Do not place a heavy object on or step on the product. The object may fall, causing serious

personal injury and serious damage to the product.

- 17 DISC**
Do not use a cracked, deformed or repaired disc. These discs are easily broken and may cause serious personal injury and product malfunction.

- 18 SERVICING**
Do not attempt to service this unit yourself as opening or removing covers may expose you to dangerous voltage or other hazards. Refer all servicing to qualified service personnel.

- 19 DAMAGE REQUIRING SERVICE**
Unplug this unit from the wall outlet and refer servicing to qualified service personnel under the following conditions.

- A. When the power-supply cord or plug is damaged.
- B. If liquid has been spilled, or objects have fallen into the unit.
- C. If the unit has been exposed to rain or water.
- D. If the unit does not operate normally by following the operating instructions. Adjust only those controls that are covered by the operating instructions. Improper adjustment of other controls may result in damage and will often require extensive work by a qualified technician to restore the unit to its normal operation.
- E. If the unit has been dropped or the cabinet has been damaged.
- F. When the unit exhibits a distinct change in performance-this indicates a need for service.

- 20 REPLACEMENT PARTS**
When replacement parts are required, have the service technician verify that the replacements he uses have the same safety characteristics as the original parts. Use of replacements specified by the unit manufacturer can prevent fire, electric shock, or other hazards.

- 21 SAFETY CHECK**
Upon completion of any service or repairs to this unit, ask the service technician to perform safety checks recommended by the manufacturer to determine that the unit is in safe operating condition.

- 22 WALL OR CEILING MOUNTING**
The product should be mounted to a wall or ceiling only as recommended by the manufacturer.

- 23 HEAT**
The product should be situated away from heat sources such as radiators, heat registers, stoves, or other products (including amplifiers) that produce heat.

- 24** To prevent battery electrolyte leakage, which may result in injury and damage to the unit or other objects, observe the following precautions:

- A. All batteries must be installed with the proper polarity.
- B. Do not mix new with old or used batteries.
- C. Only use batteries of the same type and brand.
- D. Remove the batteries when they are not to be used for a long period time.
- E. When the batteries have become discharged, they must be disposed of in a safe manner which complies with all applicable laws.

- 25 WEEE (Waste Electrical and Electronic Equipment)**
The meaning of the symbol on the product, its accessory or packaging indicates that this product shall not be treated as household waste. Please, dispose of this equipment at your applicable collection point for the recycling of electrical & electronic equipments waste. In the European Union and Other European countries which there are separate collection systems for used electrical and electronic product. By ensuring the correct disposal of this product, you will help prevent potentially hazardous to the environment and to human health, which could otherwise be caused by unsuitable waste handling of this product. The recycling of materials will help conserve natural resources. Please do not therefore dispose of your old electrical and electronic equipment with your household waste. For more detailed information about recycling of this product, please contact your local city office, your household waste disposal service or the shop where you purchased the product.



INTRODUCTION

Important Safeguards _____ i
Table of Contents _____ 1
Overview _____ 2
Identification of Controls _____ 6

CONNECTIONS

Connecting Antenna/Cable _____ 12
Connecting a TV _____ 13
Connecting an Amplifier/Receiver _____ 14
Connecting Optional Equipment _____ 15
Connecting a Digital Camcorder _____ 15

SETUP

Initial Installation _____ 16
Initial Setup _____ 17

- Setup Menu Overview _____ 17
- INSTALLATION Settings _____ 17
- RECORDING OPTIONS Settings _____ 21
- LANGUAGE Settings _____ 22
- PREFERENCE / Audio Settings _____ 23
- PREFERENCE / Parental Controls _____ 24
- Various PREFERENCE Settings _____ 25
- Preferences / VCR _____ 26
- Preferences / Modulator Out _____ 27
- System Information _____ 28
- Restore Defaults _____ 28

On-Screen Display Overview _____ 29

PLAYBACK

DVD Playback _____ 31
VCR Playback _____ 34
Other Disc Playback _____ 36

RECORDING

Basic Recording _____ 39

- Recording from TV _____ 39
- One Touch Record (OTR) _____ 39
- Checking the Recording Time _____ 40
- To Pause the Recording _____ 40
- One Touch Copy - DVD to VHS _____ 40
- Copy Edit (DVD → VCR) _____ 41
- One Touch Copy - VHS to DVD _____ 41
- Copy Edit (VCR → DVD) _____ 41

Timer Recording _____ 42
Recording from an External Input _____ 45

DISC OPERATION

Disc Initialize _____ 47
Disc Operation in DVD±RW disc _____ 47
Disc Operation in DVD±R, DVD-RW disc _____ 49

DISC EDIT

Title Menu _____ 50

REFERENCE

Troubleshooting _____ 53
Technical Specifications _____ 56

DVD, DVD+R, DVD+RW?

What is a DVD?

DVD (Digital Versatile Disc) is a storage medium that combines the convenience of the compact disc with the latest digital video technology. DVD video uses modern MPEG2 data compression technology that enables an entire feature film to be stored on a single five inch disc.

How good is the resolution of DVD compared with VHS?

The razor-sharp digital images have more than 500 lines of resolution at 720 pixels per line. This is more than twice as high as VHS and even better than laser disc quality. DVD picture quality is easily comparable to the digital masters produced in recording studios.

What is a DVD+RW?

DVD+ReWritable uses 'phase change' media, the same technology on which rewritable CDs are based. A high-performance laser is used to change the reflective properties of the recording layer; this process can be repeated more than a thousand times.

What is a DVD+R?

Unlike a DVD+RW disc, a DVD+R (write-once DVD) can only be written to once. If it is not finalized after a recording, further recordings can be added to it. Old recordings can be deleted but they can no longer be overwritten. The deleted recordings (titles) are marked 'deleted title'.

Before a DVD+R can be played in a DVD player, it must be finalized in the DVD Recorder+VCR. Once this process is complete, no further recordings can be added.

What can I do with my DVD Recorder+VCR?

Your DVD Recorder+VCR is a machine for recording and playing back digital video discs with 'two-way' compatibility with the universal DVD video standard. This means:

- existing DVD video discs can be played on the recorder.
- recordings made on your DVD Recorder+VCR can be played on other DVD video players and DVD-ROM drives.

Dual Media

Supporting Disc	±RW / ±R
Recording Format	±Disc + VR format
Finalize	-RW, -R, +R
After finalize other DVD playback	All disc can playback
Consumer	Does not need selection (recording format)

Remark :

A DVD Recorder+VCR that supports 'dual media' recording allows DVD+RW format recording (+VR) on either DVD-R, DVD-RW, DVD+R or DVD+RW media. Any editing feature that is available with the +RW logical format is available on any of the media types. This system allows the flexibility for the consumer to use any of the above media formats for recording in the same system. Since the +VR format is DVD-Video compatible, the consumer can take any disk recorded on this platform and should be capable of playing it back on the majority of DVD players on the market.

Regional code



If the region number on your DVD disc does not correspond to the region number of this player, the disc cannot be played.

Which discs you can use

The following discs can be used in your DVD Recorder+VCR:

Playback and recording

DVD+RW (Digital Versatile Disc + ReWritable)
 DVD-RW (DVD-Rerecordable)
 DVD+R (Digital Versatile Disc + Recordable)
 DVD-R (DVD-Recordable)

Playback only

DVD Video (Digital Versatile Disc)
 VCD (Video CD)
 Audio CD (Compact Disc Digital Audio)
 CD-R (CD recordable) Audio/ CD-RW (CD rewritable) Audio
 Video Format : JPEG
 Audio Format : CDDA / MP3



Not all recordable CDs may be played by your player.

Disc-related Terms

Title (DVD only)

The main film, accompanying feature content, or music album. Each title is assigned a title reference number enabling you to locate it easily.

Chapter (DVD only)

Sections of a movie or a musical piece that are smaller than titles. A title is composed of one or several chapters. Each chapter is assigned a number to enable you to easily locate the chapter you want. Depending on the disc, chapters may not be labeled.

Track (Audio CD only)

Sections of a movie or a musical piece on an audio CD. Each track is assigned a number, enabling you to easily locate the track you want.

About DVD Recording

Notes on Recording

- The recording times shown are not exact because the DVD Recorder+VCR uses variable bit-rate video compression. This means that the exact recording time will depend on the material being recorded.
- When recording a TV broadcast, if the reception is poor or the picture contains interference, the recording times may be shorter.
- Discs recorded at high speeds (equal to or greater than 2X) may not be recognized.
- If you record still pictures or audio only, the recording time may be longer.
- The displayed times for recording and time remaining may not always add up to the exact length of the disc.
- The available recording time may decrease if you heavily edit a disc.
- When using a DVD+R disc, you can keep recording until the disc is full, or until you finalize the disc. Before you start a recording session, check the amount of recording time left on the disc.

Recording TV Audio Channels

The DVD Recorder+VCR can record one or two channel audio. For TV broadcasts, this usually means mono or stereo, but some programs are broadcast with a main and a SAP (Secondary Audio Program) audio channel. You can record either the main audio or the SAP audio.

Restrictions on Video Recording

- You cannot record copy-protected video using this DVD Recorder+VCR. Copy-protected video includes DVD-Video discs and some satellite broadcasts. If copy-protected material is encountered during a recording, recording will pause or stop automatically and an error message will be displayed on-screen.
- Video that is 'copy-once only' can only be recorded using DVD+RW discs with CPRM.

Copyright Notice

- Audio and video recordings you make using the DVD Recorder+VCR are for your personal use only. You may not sell, lend, or rent them to other people.
- This product incorporates copyright protection technology that is protected by method claims of certain U.S. patents and other intellectual property rights owned by Macrovision Corporation and other rights owners. Use of this copyright protection technology must be authorized by Macrovision Corporation, and is intended for home and other limited viewing uses only unless otherwise authorized by Macrovision corporation. Reverse engineering or disassembly is prohibited.

Precautions

Handling the Unit

When shipping the unit

The original shipping carton and packing materials come in handy. For maximum protection, re-pack the unit as it was originally packaged at the factory.

When setting up the unit

The picture and sound of a nearby TV, VCR, or radio may be distorted during playback. In this case, position the unit away from the TV, VCR, or radio, or turn off the unit after removing the disc.

To keep the surface clean

Do not use volatile liquids, such as insecticide spray, near the unit. Do not leave rubber or plastic products in contact with the unit for a long period of time. They will leave marks on the surface.

Cleaning the Unit

To clean the cabinet

Use a soft, dry cloth. If the surfaces are extremely dirty, use a soft cloth lightly moistened with a mild detergent solution. Do not use strong solvents such as alcohol, benzine, or thinner, as these might damage the surface of the unit.

To obtain a clear picture

The DVD Recorder+VCR is a high-tech, precision device. If the optical pick-up lens and disc drive parts are dirty or worn, the picture quality will be poor. Regular inspection and maintenance are recommended after every 1,000 hours of use. (This depends on the operating environment.) For details, please contact your nearest dealer.

Remote Control Operation Range

Point the remote control at the remote sensor and press the buttons.

Distance: Within 23 ft (7 m) of the remote sensor.

Angle: Within 30° in each direction of the remote sensor.

Remote Control Battery Installation

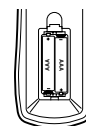

Detach the battery cover on the rear of the remote control, and insert two AAA batteries. Make sure the polarities (+ and -) are aligned correctly.



Caution

Do not mix old and new batteries. Never mix different types of batteries (standard, alkaline, etc.).

Notes on Discs

Handling Discs

Do not touch the playback side of the disc. Hold the disc by the edges so that fingerprints will not get on the surface. Do not stick paper or tape on the disc.

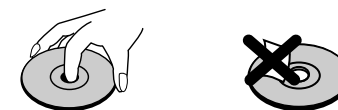

Storing Discs

After playing, store the disc in its case.

Do not expose the disc to direct sunlight or sources of heat, or leave it in a parked car exposed to direct sunlight, as there may be a considerable temperature increase inside the car.

Cleaning Discs

Fingerprints and dust on the disc can cause poor picture quality and sound distortion. Before playing, clean the disc with a clean cloth. Wipe the disc from the center outward.

Do not use strong solvents such as alcohol, benzine, thinner, commercially available cleaners, or anti-static spray intended for older vinyl records.

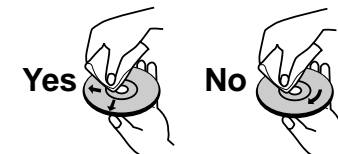

About Symbols

About the Symbol

'' may appear on the TV screen during operation. This icon means the function explained in this User's Guide is not available on that specific disc.

Front Panel

DF-x5xx

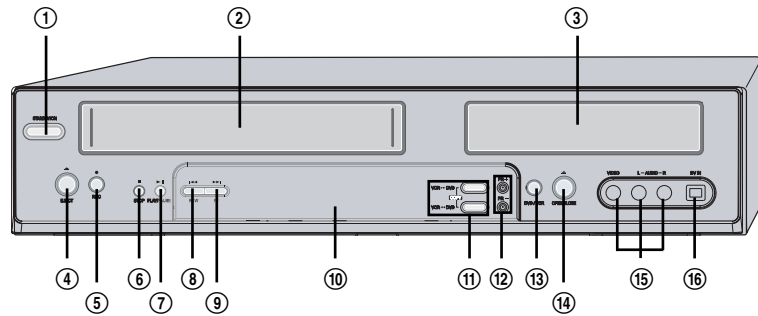

DF-x7xx

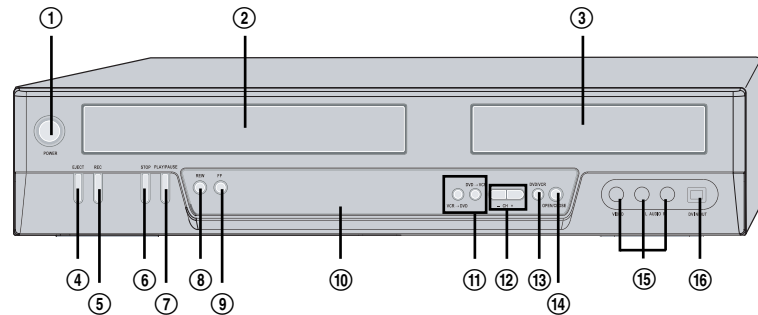

DF-x4xx

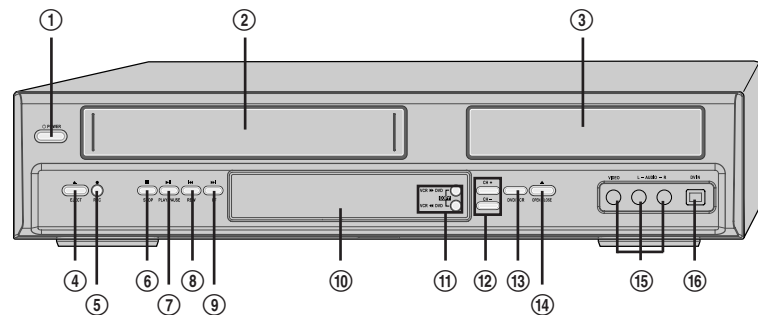

- ① **POWER (STANDBY/ON)**
Turns the DVD Recorder+VCR on and off.
- ② **Cassette Compartment (VCR deck)**
Insert a video cassette here.
- ③ **Disc Tray (DVD deck)**
Insert a disc here.
- ④ **VCR EJECT**
Ejects the tape in the VCR deck.
- ⑤ **REC**
Starts recording. Press repeatedly to set the recording time.
- ⑥ **STOP**
Stops playback.
- ⑦ **PLAY/PAUSE**
Starts playback of a disc or tape. Pauses playback or recording temporarily.
- ⑧ **REW**
DVD: Skips to previous chapter.
VCR: Rewinds the tape during Stop mode. Press during Play mode for fast reverse picture search.
- ⑨ **FF**
DVD: Skips to next chapter.
VCR: Advances the tape during Stop mode. Press during Play mode for fast forward picture search.
- ⑩ **Front Panel Display**
Shows the current status of the DVD Recorder+VCR.
- ⑪ **COPY**
Copies from DVD to VCR (or from VCR to DVD).
- ⑫ **PR+/-**
Scans up or down through memorized channels. Also moves up and down in DVD navigation menus.
- ⑬ **SELECT DVD/VCR**
Toggles control between the DVD deck and the VCR deck.
- ⑭ **OPEN/CLOSE**
Opens or closes the disc tray.
- ⑮ **Front AV (VIDEO, L-AUDIO-R)**
Connects to the audio/video output of an external source (VCR, Camcorder, etc.).
- ⑯ **DV IN** **DV model only**
Connects to the DV output of an external source (VCR, Camcorder, etc.).

Front Panel Display

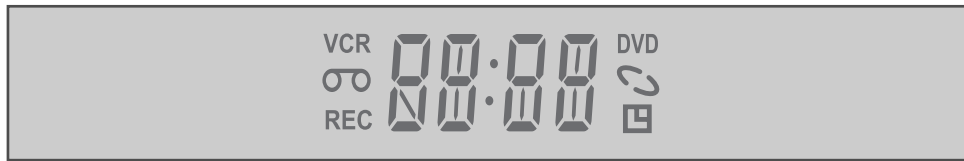

Channel

PR23 TV Channel

Input mode

AV-1 AV1 input

AV-2 AV2 input

F-AV Front AV input

DV DV input **DV model only**

Copy

COPY DVD to VCR copying

COPY DVD VCR to DVD copying

Recording on disc

11:15 Indicates a DVD Timer recording is set.

11:15 Indicates a DVD Timer Recording is in standby mode.

REC Indicates the DVD is recording.

0:30 OTR Recording mode

RECP Recording Pause mode

Recording on tape

11:15 Indicates a VCR Timer Recording is set.

11:15 Indicates a VCR Timer Recording is in standby mode.

REC Indicates the VCR is recording.

0:30 OTR Recording mode

RECP Recording Pause mode

Others

SAFE Indicates when the DVD Recorder+VCR is locked.

VCR Indicates the DVD Recorder+VCR is in VCR mode (set by [TV/VCR] button).

TV Indicates the DVD Recorder+VCR is in TV mode (set by [TV/VCR] button).

I-S Indicates when the DVD Recorder+VCR is outputting the video signal in Interlaced Scan mode.









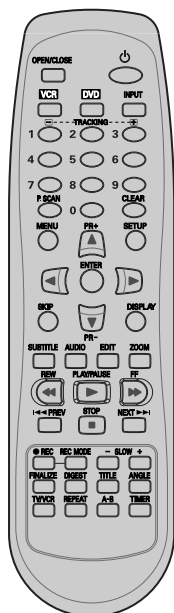



P-S Indicates when the DVD Recorder+VCR is outputting the video signal in Progressive Scan mode.

Remote Control



- Turns the DVD Recorder+VCR on and off.
- Opens and closes the disc tray in DVD mode.
- Ejects the tape in the VCR deck in VCR mode.
- Selects VCR mode.
- Selects DVD mode.
- Switches the DVD Recorder+VCR input to TV tuner, AV1, AV2, FAV or DV.
- Selects numbered options in menus.
- Selects TV channels.
- Manually adjusts tracking.
- Press and hold for 3 seconds to switch between Progressive Scan and Interlace Scan mode.
- Resets the tape counter in VCR mode.
- Accesses DVD disc menus.
- Displays or exits the Setup menu.
- VCR: Commercial Skip skips forward 30 seconds.
- Displays information about the currently loaded disc, VHS tape, or TV channel.
- : Selects menu options.
- PR(+/-) : Selects channels.
- Confirms menu selections.
- Selects a subtitle language, if available.
- Selects an audio language (DVD), audio channel (CD) or audio type (TV).
- Displays the edit menu for DVD+RW/+R discs or sets a chapter marker.
- Enlarges the DVD video image.
- Starts playback.
- Pauses playback or recording temporarily. Press again to exit Pause mode.
- DVD: Searches backward/forward.
- VCR: Rewinds/advances during Stop mode. Press during Play mode for fast reverse/forward picture search.



-  Stops playback or recording.
-  Skips to the next or previous chapter/track.
-  Starts recording. Press repeatedly to set the recording time. For more details, Refer to One Touch Record (OTR) on page 40.
-  Selects Recording mode: - DVD : Approx 1 Hour (HQ mode), 2 Hours (SP mode), 4 Hours (EP mode), 8 Hours (SEP mode) - VCR : SP or LP.
-  Increases or decreases the slow motion speed when playing a DVD or VHS tape.
-  Displays the finalize menu for DVD+R discs.
-  Displays the digest menu for DVD+RW/+R discs.
-  Displays a disc's Title menu, if available.
-  Selects a DVD camera angle, if available.
-  Switches between the DVD Recorder+VCR tuner and your TV tuner.
-  Repeats the current chapter, track, title or the entire disc.
-  Repeats playback between two points (A and B).
-  Displays the Timer Recording menu.

-  **Progressive Scan Mode**
- If your TV supports Progressive Scan, you can view high quality video by setting the DVD Recorder+VCR to Progressive Scan mode. If your TV does not support Progressive Scan, do NOT change to Progressive Scan mode. If you do so accidentally, press and hold the [P.SCAN] button for 3 seconds to restore normal viewing.
 - When video output mode is changed from RGB to Interlace or Progressive (Scart 1) will not be correct colour for Component video.
 - As component outputs have their own Jacks on the back side, change the TV input into Component input, after connecting the component cables from the DVD Recorder+VCR to TV.
 - Changing from Interlace or Progressive to RGB, should be the opposite of above.

CONSUMERS SHOULD NOTE THAT NOT ALL HIGH DEFINITION TELEVISION SETS ARE FULLY COMPATIBLE WITH THIS PRODUCT AND MAY CAUSE ARTIFACTS TO BE DISPLAYED IN THE PICTURE. IN CASE OF 525 PROGRESSIVE SCAN PICTURE PROBLEMS, IT IS RECOMMENDED THAT THE USER SWITCH THE CONNECTION TO THE 'STANDARD DEFINITION' OUTPUT. IF THERE ARE QUESTIONS REGARDING OUR TV SET COMPATIBILITY WITH THIS MODEL 525p DVD PLAYER, PLEASE CONTACT OUR CUSTOMER SERVICE CENTER.

Rear panel

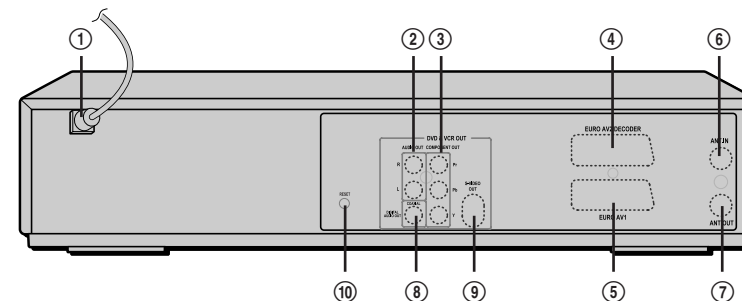

- ① **AC Power Cord**
Plug into a power outlet.
- ② **AUDIO OUT (L, R)**
Connect to a TV or other equipment with audio inputs.
- ③ **COMPONENT/PROGRESSIVE VIDEO OUT (Y Pb Pr)**
Connect to a TV with Component Video (Y Pb Pr) inputs.
- ④ **Scart socket 2**
Connection of an additional device (satellite receiver, set-top box, video recorder, camcorder, etc.)
- ⑤ **Scart socket 1**
Connection of a TV set. Composite-output and RGB-output
- ⑥ **RF IN (FROM ANT.)**
Connect to your antenna or cable TV outlet.
- ⑦ **RF OUT (TO TV)**
Connect to a TV with an RF coaxial input.
- ⑧ **COAXIAL (Digital Audio Out)**
Connect to an amplifier with a coaxial digital audio input.
- ⑨ **S-VIDEO OUT**
Connect to a TV with an S-Video Input.
- ⑩ **RESET Button**
Recover from system down.

-  **Caution**
- Do not touch the inner pins of the jacks on the rear panel. Electrostatic discharge may cause permanent damage to the DVD Recorder+VCR.



- There are a variety of ways to connect the DVD Recorder+VCR to your TV and other equipment. Use only one of the connections described below. Whichever TV connection you use will work with all input sources.
- Please refer to the manuals for your TV, VCR, stereo system, or other devices as necessary to make the best connections.
- For better sound reproduction, connect the DVD Recorder+VCR's AUDIO OUT jacks to the audio in jacks of your amplifier, receiver, stereo, or audio/video equipment. See 'Connecting an Amplifier/Receiver' on page 13.



Caution

- Make sure the DVD Recorder+VCR is connected directly to the TV, and the TV is set to the correct video input.
- Do not connect the DVD Recorder+VCR's AUDIO OUT jack to the phono in jack (record deck) of your audio system.
- Do not connect the DVD Recorder+VCR via your VCR. The DVD image could be distorted by the copy protection system.

Connecting Antenna/Cable

- 1 Disconnect the antenna/cable from the rear of your TV.
- 2 Connect this cable to the jack marked ANT IN (FROM ANT.) on the rear panel of the DVD Recorder+VCR.

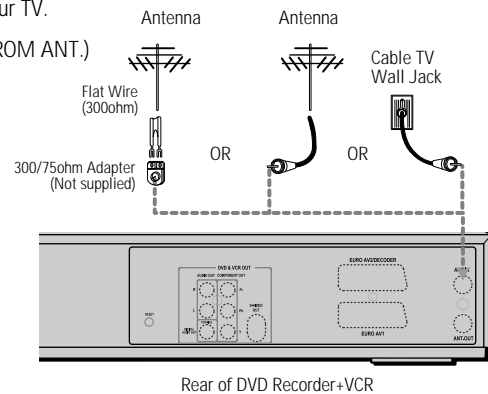

If your cable wire is connected to your TV without a converter or descrambler box, unscrew the wire from your TV and attach it to the ANT IN (FROM ANT.) jack on the rear panel of the DVD Recorder+VCR.

Use the supplied coaxial cable to connect between the DVD Recorder+VCR's OUT (TO TV) jack and the antenna input jack on your TV. With this connection, you can receive all midband, superband, and hyperband channels (all cable channels).

Connecting a TV

Choose one of the following TV connections, depending on the capabilities of your equipment.

RF Connection

Connect the RF OUT (TO TV) jack on the DVD Recorder+VCR to the antenna in jack on your TV using the supplied 75-ohm RF cable (R). If you use this connection, tune your TV to the DVD Recorder+VCR's RF output channel (CH52).

Scart Connection

- 1 Plug a scart cable into the scart socket EURO AV1 at the back of the DVD Recorder+VCR and the corresponding scart socket at the back of the TV set. (V)
- 2 Plug a scart cable into the blue scart socket EURO AV2/DECODER at the back of the DVD Recorder+VCR and the corresponding scart socket at the back of a satellite decoder or set top box.

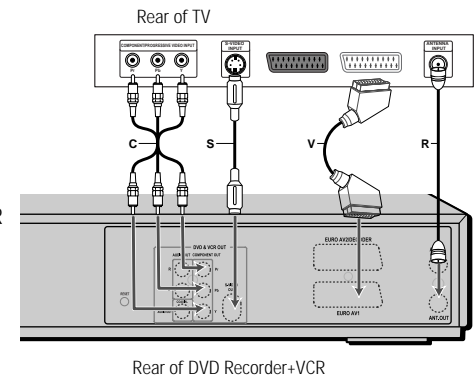

S-Video Connection

- 1 Connect the S-VIDEO OUT jack on the DVD Recorder+VCR to the S-Video in jack on your TV using an S-Video cable (S).
- 2 Connect the Left and Right AUDIO OUT jacks from the DVD Recorder+VCR to the left/right audio in jacks on your TV using the supplied audio cables.

Component Video Connection

- 1 Connect the COMPONENT/PROGRESSIVE VIDEO OUT jacks on the DVD Recorder+VCR to the corresponding input jacks on your TV using a Y Pb Pr cable (C) if the Component Video jacks (Y, Pb, Pr) are available on your TV.
- 2 Connect the Left and Right AUDIO OUT jacks from the DVD Recorder+VCR to the left/right audio in jacks on your TV using the supplied audio cables.

Progressive Scan Connection

- If your television is a high-definition or 'digital ready' television, you may take advantage of the DVD Recorder+VCR's Progressive Scan output for the highest video resolution possible.
- If your TV does not accept the Progressive Scan format, the picture will appear scrambled.

- 1 Connect the COMPONENT/PROGRESSIVE VIDEO OUT jacks on the DVD Recorder+VCR to the corresponding in jacks on your TV using an optional Y Pb Pr cable (C).
- 2 Connect the Left and Right AUDIO OUT jacks from the DVD Recorder+VCR to the left/right audio in jacks on your TV using the supplied audio cables.



- Be sure to set the DVD Recorder+VCR to Progressive Scan mode by pressing and holding [P.SCAN] for 3 seconds (or changing the Video Output in the Setup Menu; see page 23).
- Progressive Scan does not work with the RF, Audio/Video or S-Video connections.

Connecting an Amplifier/Receiver

Connecting to an amplifier equipped with two channel analog stereo or Dolby Pro Logic II/Pro Logic

Connect the Left and Right AUDIO OUT jacks on the DVD Recorder+VCR to the left and right audio in jacks on your amplifier, receiver, or stereo system, using the supplied audio cables (A).

Connecting to an amplifier equipped with two channel digital stereo (PCM) or to an Audio/Video receiver equipped with a multi-channel decoder (Dolby Digital™, MPEG 2, or DTS)

- 1 Connect the DVD Recorder+VCR's DIGITAL AUDIO OUT jack (COAXIAL X) to the corresponding in jack on your amplifier. Use an optional digital coaxial audio cable.
- 2 You will need to activate the DVD Recorder+VCR's digital output; see 'AUDIO Settings' on page 24.

Digital Multi-Channel Sound?

A digital multi-channel connection provides the best sound quality. For this you need a multi-channel audio/video receiver that supports one or more of the audio formats supported by your DVD Recorder+VCR (MPEG 2, Dolby Digital, and DTS). Check the receiver manual and the logos on the front of the receiver.



- Due to the DTS Licensing agreement, the digital output will be in DTS digital out when DTS audio stream is selected.



- If the audio format of the digital output does not match the capabilities of your receiver, the receiver will produce a strong, distorted sound or no sound at all.
- 5.1 channel digital surround sound via the digital connection can only be obtained if your receiver is equipped with a digital multi-channel decoder.
- To see the audio format of the current DVD on the on-screen display, press [AUDIO].

The DVD Recorder+VCR does not perform internal (2- channel) decoding of DTS sound tracks. To enjoy DTS multi-channel surround, you must connect the DVD Recorder+VCR to a DTS compatible receiver via one of the DVD Recorder+VCR's digital audio outputs.

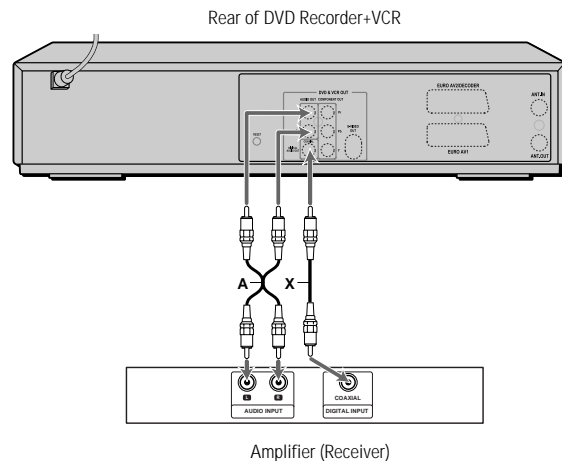

Connecting Optional Equipment

To receive audio/video signals from other equipment, connect the AVF jacks on the DVD Recorder+VCR to the audio/video out jacks on your external component, using optional audio/video cables.

Jack Panel of Accessory Component
(VCR, Camcorder, etc.)

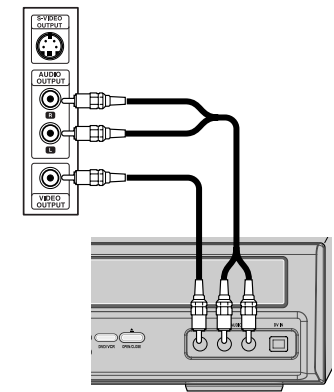

Connecting a Digital Camcorder DV model only

Using the front panel DV IN jack, it is possible to connect a DV digital camcorder, video deck or DVD+R/RW recorder and digitally transfer DV tapes or DVD+R/RW discs to DVD+R/RW.

Use a DV cable (not supplied) to connect the DV In/Out jack of your DV camcorder/video deck to the front panel DV IN jack of the DVD Recorder+VCR.



This jack is for connection to DV equipment only. It is not compatible with digital satellite tuners or D-VHS video decks.

DV Digital Camcorder

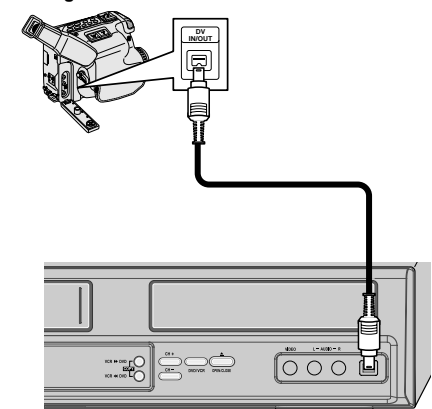

After successfully connecting your DVD Recorder+VCR to your TV and other devices, this chapter will show you how to complete the initial installation.

i You must follow the initial installation process to set the time, date, channels, and language preferences for the DVD Recorder+VCR.

- 'Initial Setup Wizard' is displayed on the screen. Make sure the RF cable from your antenna or cable TV jack is connected. Press [ENTER] to begin initial installation.
- 'OSD Lang' message is displayed on the screen. Select the desired language for the on screen menu using [▲/▼]. Press [ENTER] to confirm.
- 'Country Setting' message is displayed on the screen. Select the desired country using [▲/▼]. Press [ENTER] to confirm.
- 'Auto Scan' message is displayed on the screen. The DVD Recorder+VCR detects channels automatically and stores them in memory.
- 'Clock Set' message is displayed on the screen. Set the clock. Use [◀/▶] to move left/right and use [▲/▼] to change the settings. After setting the clock, press [ENTER] to confirm. If you cancel the process during Initial Installation, you should repeat this procedure.
- 'Adjust channels' message is displayed on the screen. Press [ENTER] to confirm.
- 'Complete' message is displayed on the screen. 'Initial Installation' process is finished.

Re-Installation

This set is equipped with the multi-tuner for receiving many countries' broadcasting. In order to receive broadcasting of different countries, follow as below.

- Press [SETUP] and select the 'Restore Defaults' using [◀/▶]. Then, RESET the set. (see page 28)
- Power On, then you see the 'Initial Installation'.
- Select the country which you want to, then repeat the steps as above.

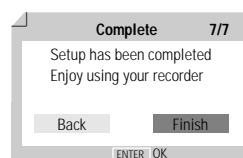
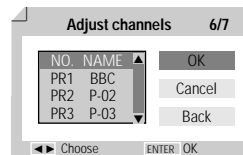
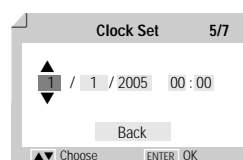
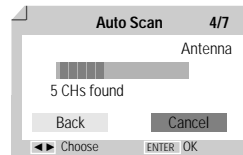
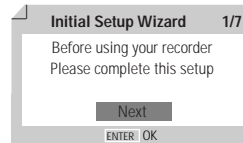

Setup Menu Overview

The DVD Recorder+VCR Setup menu includes four categories, including: Initial Setup, Disc Operation, Disc Edit and Timer Recording. Press [SETUP], [◀/▶] and [ENTER] on the remote control to view the first and second levels of the Setup menu.

- Initial Setup Screen**
go to page 17-28.

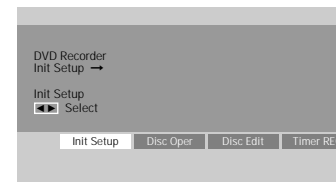

- Disc Edit Screen**
go to page 50-52.

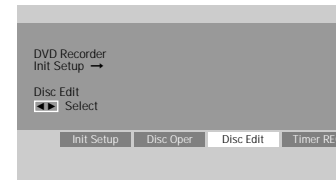

- Disc Operation Screen**
go to page 47-49.

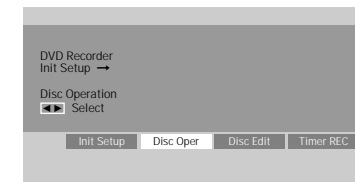

- Timer Recording Screen**
go to page 42-44.

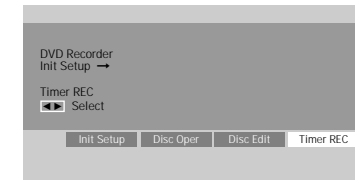

'Installation' Settings

Manual Setting

To complete the set-up of your DVD Recorder+VCR when the auto set has not stored all of the channels or when you wish to store a new channel.

- Press [SETUP]. The Setup menu appears. While 'Init Setup' is selected, press [ENTER] to go to the initial setup page.
- Use [◀/▶] to select 'Installation'.
- While 'Installation' is selected, press [▼] to select 'Manual Set'.
- Press [ENTER]. The 'Manual Set' menu appears.
- Select 'Standard' using [◀/▶]. Use [▲/▼] to select the desired 'Standard' (PAL BG, PAL DK, PAL II, or SECAM L).

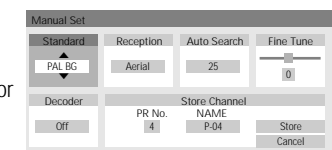

i This set is equipped with the Multi-Tuner. You can search broadcastings of other countries. If the set can not search the channels, please Re-Install. (see page 16.)

6 Select 'Reception' using [◀/▶].

Use [▲/▼] to select the desired broadcast system (Aerial or Cable).

Aerial: If you are using a standard antenna to receive channels.

Cable: If you are using basic cable to receive channels.

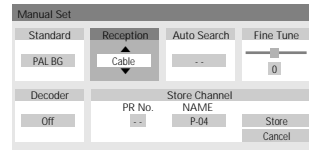

7 Select 'Auto Search' using [◀/▶].

Search the real channel number by pressing [▲/▼].

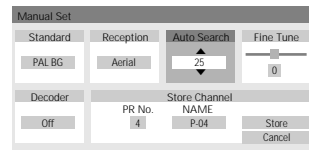

8 Select 'Fine Tune' using [◀/▶]. You can adjust the fine tuning by pressing [▲/▼].

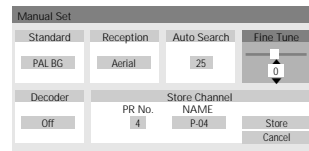

9 Select 'Decoder' using [◀/▶].

When the program is encoded (and you have a decoder connected to socket EURO AV2), press [▲/▼] to select 'On'.

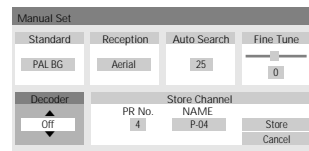

10 Select 'Store Channel' using [◀/▶].

Use [▲/▼] to select program number to store and press [ENTER].

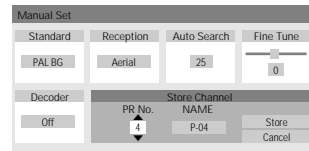

11 Select 'Program Name' using [◀/▶]. Press [ENTER] to move to the second level. If your DVD Recorder+VCR is showing no station name or is showing a station name incorrectly, you can correct this.

You can create the station name and enter a 4-digit name. Change the letters with the [▲/▼], move the next letter with the [◀/▶].

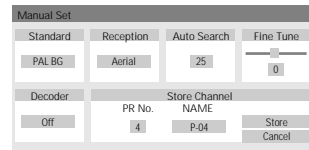

NB. You must backspace any digits already in the name box before you can enter a new name.



Auto Scan

The DVD Recorder+VCR has a frequency synthesized tuner capable of receiving up to 119 channels. These include VHF channels 2-20, 74-80, UHF channels 21-69 and CATV channels 1-41.

Preparation:

Connect the DVD Recorder+VCR to the desired type of antenna or cable TV system, as shown in 'Connecting Antenna/Cable' on page 11.

- 1 Follow steps 1-2 as shown under 'Manual Set'.
- 2 While 'Installation' is selected, press [▲/▼] to select 'Auto Scan'.
- 3 Press [ENTER] to begin the channel search.

The tuner will automatically search for all available channels in your area and place them in the tuner's memory.



After Auto Scan is complete, follow the instructions above to make sure that Tuning Band is set correctly.

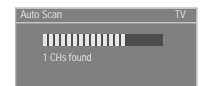

Clock Set

- 1 Follow steps 1-2 as shown under 'Manual Set'.
- 2 Use [▲/▼] to select 'Clock Set'.



- 3 Press [ENTER]. The 'Clock Set' menu appears.
- 4 Enter the date and time.
 - ◀ / ▶ (left/right): Moves the cursor to the previous or next column.
 - ▲ / ▼ (up/down): Changes the setting at the current cursor position.
- 5 Press [ENTER] to confirm your setting, then press [SETUP] to exit the Setup menu.



Adjust Channels

- 1 Follow steps 1-2 as shown under 'Manual Set'.
- 2 Use [▲/▼] to select 'Adjust Channels'.
- 3 Press [ENTER]. The 'Adjust channels' menu appears.
- 4 Use [▲/▼] to select the PR number you want to adjust. Then press [ENTER].

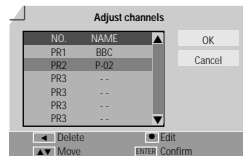
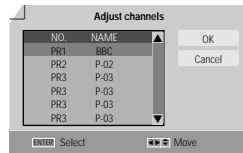

Delete

After tuning TV stations into your DVD Recorder+VCR, you may wish to delete a station.

- 1 Select the PR number you want to delete using [▲/▼].
- 2 Press [◀]. The selected PR will be deleted.
- 3 Select 'OK' to exit.

Edit

After tuning TV stations into your DVD Recorder+VCR, you may wish to put a name into any channel you want to.

- 1 Select the PR number you want to edit using [▲/▼].
- 2 Press [●]. You can put a name by pressing [▲/▼] and [◀/▶].
- 3 Select 'OK' to exit.

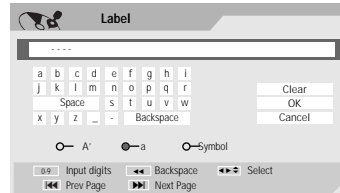

Sort channels

After tuning TV stations into your DVD Recorder+VCR, you may wish to change the order of PR's you have in your set, as your preference.

- 1 Select the PR number you want to move using [▲/▼].
- 2 Press [▲/▼] to select the PR number you want to move to.
- 3 Press [ENTER]. The selected PR Will be moved to the new PR number.
- 4 Select 'OK' to exit.

'Recording Options' Settings

DVD Record Quality

You can set the default DVD recording quality to: HQ (High Quality - 1 hr/disc), SP (Standard Quality - 2 hrs/disc), EP (Extended Play - 4 hrs/disc) or SEP (Very Low Quality - 8 hrs/disc).

- 1 Press [SETUP]. The Setup menu appears.
While 'Init Setup' is selected, press [ENTER] to go to the initial setup page.
- 2 Use [◀/▶] to select 'Recording Options'.
- 3 While 'Recording Options' is selected, press [▼] to select 'DVD Quality'.
- 4 Press [▶] to move to the second level.
- 5 Use [▲/▼] to select the desired Record Quality (HQ, SP, EP or SEP).
- 6 Press [ENTER] to confirm your selection, then press [SETUP] to exit the menu.

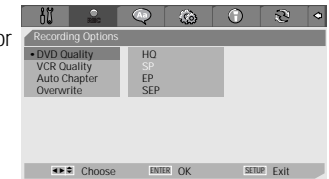

VCR Record Quality

You can set the default VCR recording quality to SP (Standard Play) or LP (Long Play). SP is higher quality, but LP provides 2 times the recording time; e.g., a 2 hour tape will record for 4 hours in LP mode.

Follow the same procedure as the 'DVD Record Quality'.

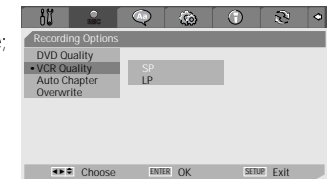

Auto Chapter

During recording, chapter markers are added automatically at fixed intervals.

You can set this interval to **5 min**, **10 min** or **15 min**.

But when you set DVD Record quality "SEP", Auto Chapter interval could be set only '10 min' or '15 min'.

To turn off automatic chapter marking, select '**Off**'.

Follow the same procedure as 'DVD Record Quality'.

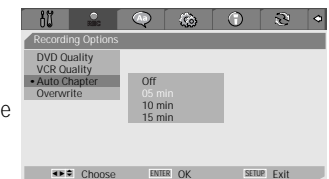

Overwrite

Immediately begins recording over the currently selected title.

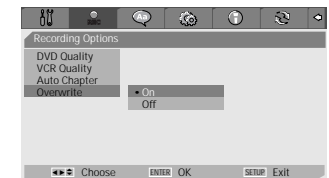

'Language' Settings

OSD Language

Select a language for the DVD Recorder+VCR Setup menu and on-screen displays.

- 1 Press [SETUP]. The Setup menu appears.

While 'Init Setup' is selected, press [ENTER] to go to the initial setup page.

- 2 Use [◀] and [▶] to select 'Language' .

- 3 While 'Language' is selected, press [▼] to select 'OSD Lang'.

- 4 Press [▶] to move to the second level.

- 5 Use [▲/▼] to select the desired language.

- 6 Press [ENTER] to confirm your selection, then press [SETUP] to exit the menu.



Menu/Subtitle/Audio Language

Select your preferred language for Disc Menus, Subtitles, and Audio soundtracks.

Follow the same procedure as the OSD Language.



'Preferences' / Video Settings

- 1 Press [SETUP]. The Setup menu appears.

While 'Init Setup' is selected, press [ENTER] to go to the initial setup page.

- 2 Use [◀/▶] to select 'Preferences' .

- 3 While 'Preferences'  is selected, press [▼] to select 'Video'.

- 4 Press [▶]. The 'Video' submenu is displayed.

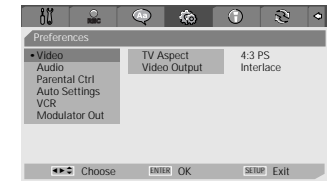

TV Aspect Ratio

- 1 Use [▲/▼] to select 'TV Aspect' while the 'Video' submenu is displayed.

- 2 Press [▶] to go to the second level.

- 3 Use [▲/▼] to select the desired TV Aspect.

- 4 Press [ENTER] to confirm your selection.

- 5 Press [SETUP] to exit the menu.

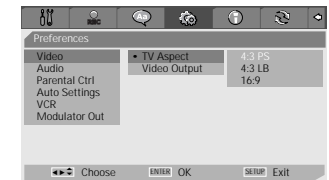

4:3 PS : Select when a standard 4:3 TV is connected. Displays pictures cropped to fill your TV screen. Both sides of the picture are cut off.

4:3 LB : Select when a standard 4:3 TV is connected. Displays theatrical images with masking bars above and below the picture.

16:9 : Select when a 16:9 wide screen TV is connected.

Video Output

Progressive Scan Video provides the highest picture quality with reduced flickering.

Interlace or Progressive : If you connect the DVD Recorder+VCR to a digital television (DTV) or Monitor using the COMPONENT jacks, set Video Output to 'Interlace' or 'Progressive'.

RGB : If you connect the DVD Recorder+VCR to an analog television using the SCART jacks, set Video Output to 'RGB'.

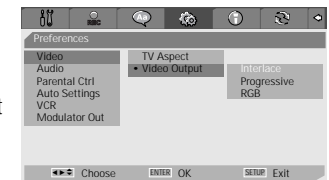

Follow the same procedure as TV Aspect Ratio to change the Video Output.



Caution

Once the Progressive Scan setting is entered, an image will only be visible on a Progressive Scan compatible TV or monitor.

'Preferences' / Audio Settings

- 1 Press [SETUP]. The Setup menu appears.
While 'Init Setup' is selected, press [ENTER] to go to the initial setup page.
- 2 Use [◀/▶] to select 'Preferences' .
- 3 While 'Preferences'  is selected, press [▼] to select 'Audio'.
- 4 Press [▶]. The 'Audio' submenu is displayed.



Digital Output

- 1 Use [▲/▼] to select 'Digital Output' while the Audio submenu is displayed.
- 2 Press [▶] to go to the second level.
- 3 Use [▲/▼] to select the desired digital output type.
- 4 Press [ENTER] to confirm your selection.
- 5 Press [SETUP] to exit the menu.

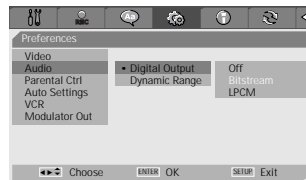

Off

No signal will be output from the Digital Audio Out jacks.

Bitstream

Select when connected to a Dolby Digital or DTS decoder (or an amplifier or other equipment with a Dolby Digital or DTS decoder).

LPCM

Select when connected to a digital amplifier. The DVD Recorder+VCR's digital audio signal will be output in the PCM format when you play a DVD recorded with a Dolby Digital (only for DVD) or MPEG soundtrack. If the DVD is recorded with a DTS sound track then no sound will be heard.

Dynamic Range

While watching DVD movies, you may wish to compress the dynamic range of the audio output (the difference between the loudest and quietest passages). This allows you to listen to a movie at a lower volume without losing clarity of sound.

Set 'Dynamic Range' to anymode you want for this effect.

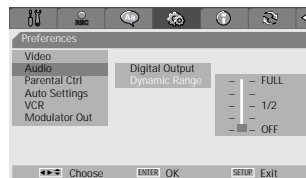

Follow the same procedure as 'Digital Output' to set the Dynamic Range.



'Preferences' / Parental Controls

Set Parental Level

The Parental Controls feature allows you to prevent DVDs from being played based on their ratings or to have certain discs played with alternative scenes. You can set the parental level from 'ADULT' to 'KID SAFE'.

- 1 Press [SETUP]. The Setup menu appears.
While 'Init Setup' is selected, press [ENTER] to go to the initial setup page.
- 2 Use [◀/▶] to select 'Preferences' .
- 3 While 'Preferences'  is selected, press [▼] to select 'Parental Ctrl'.
- 4 Press [▶]. The 'Parental' submenu is displayed.

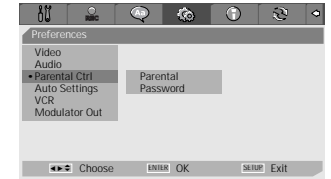

- 5 The Password Input dialog will appear. Enter a 4-digit password using the [0-9] buttons. If this is the first time you have entered a password, you will be prompted to enter the password again to confirm it.

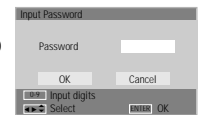

 The initial password is '3308'. You must enter this password before you can change the Parental Level.

After setting the password, press [ENTER].

- 6 Enter your new password.

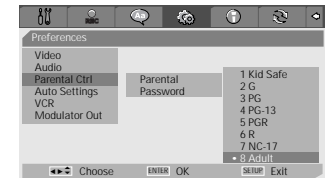

- 7 Use [▲/▼] to select the desired parental level and press [ENTER] to confirm.

Adult to Kid Safe : Some discs contain scenes not suitable for children. If you set a rating for the DVD Recorder+VCR, all scenes with the same rating or lower will be played. Higher rated scenes will not be played unless an alternative scene is available on the disc. The alternative must have the same rating or a lower one. If no suitable alternative is found, playback will stop. You must enter the 4-digit password or change the rating level in order to play the disc.

- 8 Press [ENTER] to confirm your rating selection, then press [SETUP] to exit the menu.

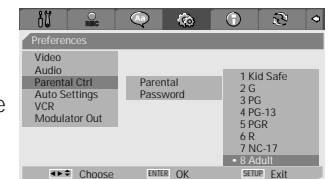

Change Password

- 1 While 'Preferences'  is selected, press [▼] to select 'Parental Ctrl'.
- 2 Press [▶] to select 'Password'. Then press [ENTER].
- 3 The 'Input Password' submenu appears. Enter your current 4-digit password then press [ENTER].
- 4 Enter a new 4-digit password, then press [ENTER]. Re-enter the new password to confirm, press [ENTER].

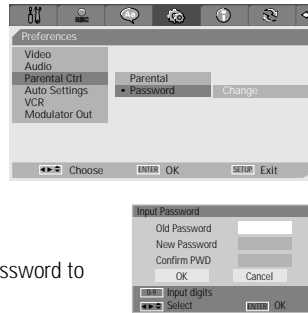



- **Master Password** : If you forget your password, press 3,3,0,8 on the remote control and then press [ENTER].
- Set the new password to something other than '0000'.

Various 'Preferences' Settings

- 1 Press [SETUP]. The Setup menu appears.

While 'Init Setup' is selected, press [ENTER] to go to the initial setup page.

- 2 Use [◀/▶] to select 'Preferences' .
- 3 While 'Preferences'  is selected, press [▼] to select 'Auto Settings'.
- 4 Press [▶]. The 'Auto Settings' submenu is displayed.

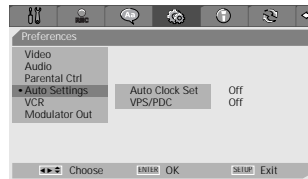

Auto Clock Set

Auto Clock enables the DVD Recorder+VCR to set the clock automatically whenever it is in Standby mode (plugged in but powered off).

Auto Clock is only available for models with the VPS/PDC function.

Some broadcasting stations may send the time and date along with the VPS/PDC data. The video will automatically use this time and date during the initial setting up procedure during normal use, and every time you switch the video off at the mains. If you find that this time and date is incorrect you can remove this feature by following the steps below changing it to the OFF mode, you will then have to manually set the time and date, see above.

- 1 Use [▲/▼] to select 'Auto Clock Set' and press [ENTER].
- 2 Use [▲/▼] to change the 'Auto Clock Set' status, and press [ENTER] to confirm.

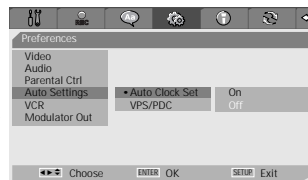

VPS/PDC

VPS/PDC is a service provided by some stations to enable you to perform timer recordings precisely even if the broadcaster delays the start time of the programme slightly. The time you enter is the VPS/PDC time so this must be correct. Not all stations offer VPS/PDC, in which case the player will start at the time you enter and not the actual start time of the programme.

If you wish to start recording at a specific time without it being adjusted by the VPS/PDC system in the event of a delay, switch VPS/PDC off otherwise the player will not record.

Follow the same procedure as 'Auto Clock Set' to set the 'VPS/PDC' status.



- "VPS/PDC" and "Auto Clock Set" are not provided for some countries.

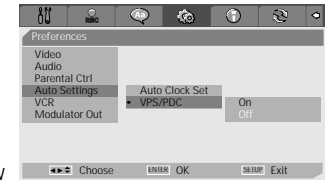

Preferences / VCR

This feature enables you to search for Index marks or specific times on your VHS tapes.

- 1 While 'Preferences' is selected, press [▼] to move to the second level.
- 2 Use [▲/▼] to select 'VCR'.
- 3 Press [ENTER] to display the submenu.
- 4 Select 'Index+', 'Index-' or 'Go to Zero'.
- 5 If you select 'Index+' (or 'Index-') and press [ENTER], your DVD Recorder+VCR will locate your index mark and begin playback.
- 6 If you select 'Go-To Search' and press [ENTER], your DVD Recorder+VCR will wind to the position 0:00:00 and stop.



- The VCR menu is activated only when a video cassette tape is inserted.



Preferences / Modulator Out

You can change the modulator out channel using the [0-9] buttons.



- "Modulator Out" is not provided for france.

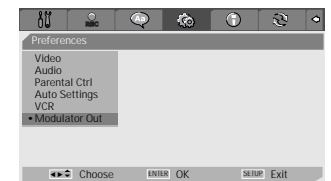

System Information

System Information helps service personnel identify key firmware information about your DVD Recorder+VCR in case service is required.

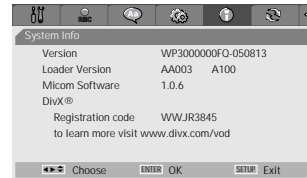

Restore Defaults

If you wish, you can reset the DVD Recorder+VCR to its original factory settings.

- 1 Press [SETUP].
- 2 Use [◀/▶] to select 'Restore Defaults'.
- 3 Press [ENTER].
- 4 The Initialize menu will appear. Use the [▲▼◀▶] buttons to select 'RESET' and press [ENTER].



- Some options cannot be reset, including Parental Controls, Password, and Country Code.
- After Restoring Defaults the unit reboots automatically and the Installation menu appears. You must set the country, language, channel, and clock setting again.

The On-Screen Display provides feedback on the status of the DVD Recorder+VCR and/or the currently loaded disc. To access the On-Screen Display (or OSD), press the [DISPLAY] button.

Displaying DVD Information

During disc playback, press [DISPLAY] to show information about the current disc.



Changing menu options in display menu

- 1 Press [DISPLAY] during playback. The on-screen display appears on the TV screen.
- 2 Use [◀▶] to select the desired icon on the on-screen display. Press [ENTER] to display a submenu.
- 3 Use [▲▼] to change the numbers. Press [ENTER] to confirm.

• Displaying icons on DVD/CDDA disc



Title : Shows the current title number and total number of titles, and skips to the desired title number.



Chapter : Shows the current chapter number and total number of chapters, and skips to the desired chapter number.



Time Elapsed : Shows the elapsed playing time, and skips to the desired time.



Audio : Shows the current audio soundtrack language, encoding method, and channel number, and changes the setting; AC3 5.1 CH English or AC3 2 CH English



Subtitle : Shows the current subtitle language, and changes the setting



Repeat : Shows the current repeat mode, and changes the setting; Chapter, Title, All or Off



A-B Repeat : Shows the current A-B repeat mode, and changes the setting; A-, A-B or Off



Random Repeat : Shows the current random repeat mode, and changes the setting; On or Off



OSD Language : Shows the current OSD language, and changes the setting



Track : Shows the current track number and total number of tracks, and skips to the desired track number.



Audio Effect : Shows the current audio effect, and changes the setting; Stereo or Mix-Mono



Sound Effect : Shows the current sound effect, and changes the setting; Off, Concert, Living Room, Hall, Bathroom, Cave, Area or Church

Displaying TV Information

While watching TV, press [DISPLAY] to display/remove the on-screen display. You would see a screen like the following:



Changing the TV Audio Channel

You can change the TV audio using the [AUDIO] button.

Press [AUDIO] repeatedly to change the TV audio, according to the Broadcast audio signal as shown below.

- **STEREO Audio Signal** : Stereo → Mono → Stereo
- **MONO Audio Signal** : Mono
- **BIL Audio Signal** : BIL1 → BIL2 → BIL1

The current audio channel is displayed on-screen.

- If the sound is poor quality when set to Stereo, you can often improve it by changing to Mono.
- When an external input is selected, the audio channel can be switched only to Stereo.

Changing TV Channels

If no disc is playing, you can change TV channels using the [0-9] or [PR+/-] buttons on the remote control or [PR+/-] buttons on the front panel.

Playing a DVD/VCD

- 1 Press [EJECT] to open the disc tray.
- 2 Load your disc in the tray with the playback side down (label side up).
- 3 Press [EJECT] to close the tray.
- 4 'LOAD' appears on the front panel display, and playback starts automatically. If playback does not start, press [PLAY (▶)]. In some cases, the Disc menu might appear instead.

Playing a DVD+R (+RW, -R, -RW)

When a DVD+RW or unfinalized DVD+R (-R, -RW) is inserted, no title is played automatically but the current TV channel displays on the screen.

- 1 If you want to play a title on the DVD+R (+RW, -R, -RW), you must press [MENU] or [PLAY] to display the disc menu of a thumbnail index for each recorded title on the disc.

The index picture screen of the title will be displayed. Also title information (name of recording, recorded day, time, recording quality) will be displayed.

- 2 Select a title to play using [◀▶] then press [ENTER] or [PLAY].



If a Disc menu is displayed

- A Disc menu may be displayed when you load a DVD. Use the [◀▶▲▼] buttons to select the title/chapter you want to view, then press [ENTER] to start playback. Press [TITLE] or [MENU] to return to the Disc menu.
- If the Parental Level feature is set and the disc is below the current Parental Level setting, the 4-digit code must be entered and/or the disc must be authorized; see 'Set Parental Level' on page 25.
- The DVD Recorder+VCR will not play discs with Region codes different from the DVD Recorder+VCR. The Region code for this DVD Recorder+VCR is 2 (two).
- Unless stated otherwise, all operations described below use the remote control. Some features may also be available in the Setup menu.
- A disc which is recorded by computer at high speeds (greater than or equal to 2x) may not be recognized.
- A disc which is recorded with unauthorized movie material may not be played.
- A disc which is recorded by other recorder or not recorded correctly may not be recognized or played.

Still Picture and Frame-by-Frame Playback

- 1 Press [PLAY/PAUSE] during playback. The DVD Recorder+VCR will go into Pause mode.
- 2 You can back up or advance the picture frame-by-frame by pressing [FF (▶▶)] repeatedly during Pause mode.

Fast Forward/Backward

- 1 Press [REW (◀◀)] or [FF (▶▶)] during playback. The DVD Recorder+VCR will go into Search mode.
- 2 Press [REW] or [FF] to select the desired speed: ▶▶ X2, ▶▶ X4, ▶▶ X8, ▶▶ X16, ▶▶ X32, ▶ (forward) or ◀, ◀◀ X2, ◀◀ X4, ◀◀ X8, ◀◀ X16, ◀◀ X32 (backward).

Slow Motion

Press [SLOW+] or [SLOW-] to enter Slow Motion mode. The default speed is 1/2. When you press [SLOW+] or [SLOW-] repeatedly, the speed will be set to 1/4, 1/8, 1/16, and normal speed.

Changing the Audio Language (DVD)

Press [AUDIO] and then press [AUDIO] repeatedly during playback to hear a different audio language or audio track.

Subtitles (DVD)

Press [SUBTITLE] and then press [SUBTITLE] repeatedly during playback to select among all available subtitle languages.

Camera Angle (DVD)

If a DVD contains scenes recorded at different camera angles, angle icon displays automatically. You can select among these angles during playback.

Press [ANGLE] and then press it repeatedly during playback to select the desired angle.

The number of the current angle appears on the TV screen.

 The Camera Angle icon is displayed on the TV screen when alternate angles are available.

Zoom

The Zoom function allows you to magnify the video image and scroll around the enlarged image.

1 Press [ZOOM] during Play mode to activate the Zoom function.

Each press of the [ZOOM] button changes the Zoom level as follows: X1 (normal size) → X2 → X3 → X4 → X1/2 → X1/3 → X1/4 → X1 (normal size)

2 Use the [◀▶▲▼] buttons to scroll around the zoomed picture.

3 To resume normal playback, press [ZOOM] repeatedly until the X1 (normal picture) appears.

 • The Zoom function may not work on some DVDs.

Repeat

1 To repeat the currently playing chapter, press [REPEAT]. REPEAT CHAPTER appears on the TV screen.

2 To repeat the currently playing title, press [REPEAT] a second time. REPEAT TITLE appears on the TV screen.

3 To repeat the whole disc, press [REPEAT] a third time. REPEAT DISC appears on the TV screen.

4 You can play in other modes (including Repeat, A-B, Shuffle, or Scan) by pressing [REPEAT] repeatedly.

 You can repeat a scene that starts when 'Repeat A-' displays on the screen. To mark the end point, press [A-B]. Press [A-B] again to repeat the scene.

A-B

You can repeat a scene between two points (A and B):

1 Press [PLAY/PAUSE] play to the start of the desired scene.

2 Press [A-B] to mark the start point.

3 Use [FF], [NEXT] to search the end point.

4 Press [A-B] to mark the end point.

5 The marked scenes are repeated continuously until you stop the repeat by pressing [A-B] button again.

Selecting Titles

When a disc has more than one title, you can select among all available titles as follows:

1 Press [DISPLAY] and use [◀▶] to select the Title icon. Press [ENTER] to display a submenu. Use [▲▼] to select the desired title number and press [ENTER] to confirm.

Selecting Chapters

When a title on a disc has more than one chapter, you can select among all available chapters as follows:

1 Press [PREV (◀◀)] or [NEXT (▶▶)] briefly during playback to select the next or previous chapter.

2 To skip directly to any chapter during playback, press [DISPLAY]. Use [◀▶] to select the Chapter icon, then press [ENTER] to display a submenu. Use [▲▼] to select the desired chapter number and press [ENTER] to confirm.

Disc Menus

Many DVDs contain Disc menus that allow you to access special features. To open a Disc menu, press [MENU]. Then use the [0-9] buttons to directly select the desired options, or use the [▲▼] buttons to highlight your desired selection and press [ENTER].

1 Press [MENU]. The Disc menu is displayed.

2 To exit the Disc menu, press [STOP].

Title Menus

1 Press [TITLE]. If the current title has a menu, the Title menu will appear on the TV screen. Otherwise, the Disc menu may appear.

2 The Title menu may contain camera angles, spoken languages and subtitle options, as well as the chapters for the title.

Digest

For displaying the edit menu for DVD+RW / +R discs, for setting chapter markers.

1 Press [DIGEST]. The Digest menu is displayed.

2 To exit the Disc menu, press [STOP].

 "Track Interval" won't be displayed in PBC ON mode.

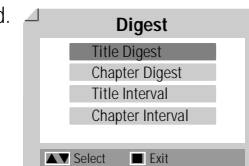

... DVD ...

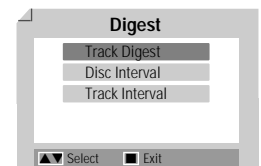

... VCD ...

Before You Begin

- 1 Press the [VCR] button to set the remote control to operate the VCR deck.
- 2 Turn the TV on and select the video input source connected to the DVD Recorder+VCR.
Audio system: Turn the audio system on and select the input source connected to the DVD Recorder+VCR.

Playing a VHS Tape

1 Insert a prerecorded video cassette.

If the DVD Recorder+VCR is powered off, it will power on automatically.
Make sure the TIMER indicator on the front panel display is not lit. If it is, press [POWER] once.
If a tape without a safety tab is inserted, the DVD Recorder+VCR will start playback automatically.



If the DVD Recorder+VCR is powered on by inserting a video cassette, playback will not start automatically.

2 Press [PLAY].

The PLAY icon appears on the TV screen. It is not necessary to select the tape speed (SP, LP) for playback. It will be automatically selected by the DVD Recorder+VCR.

3 Press [STOP] to stop playback.

The STOP icon appears on the TV screen. If the tape reaches the end before [STOP] is pressed, the DVD Recorder+VCR will automatically stop, rewind, and eject the tape.

Tracking Control

Auto Tracking

The automatic tracking function adjusts the picture to remove snow or streaks. It works in the following cases:

- When a tape is played for the first time.
- When the tape speed (SP, LP) changes.
- When streaks or snow appear because of scratches on the tape.

Manual Tracking

If noise appears on the screen during playback, press the [TRACKING +/-] buttons on the remote control until the noise on the screen is reduced.

- In case of vertical jitter, adjust these controls very carefully.
- Tracking is automatically reset to normal when the tape is ejected or the power cord is unplugged for more than 3 seconds.

Special Playback Features

Notes on special playback features

Horizontal lines (noise bars) will appear on the TV screen. This is normal.

The audio is automatically muted during special playback modes, so there is no sound during search, slow motion, etc. During high-speed picture search, a short time is needed to stabilize tape speed when re-entering Play mode. Slight interference may be observed during this time.

Fast Forward/Backward

This function lets you visually search forward and backward for a desired scene on your tape.

1 Press [REW] or [FF] during playback.

Search mode will be activated.

If the DVD Recorder+VCR is left in Search mode for more than 3 minutes, the DVD Recorder+VCR will automatically resume Play mode to protect the tape and video heads.

2 To return to normal playback, press [PLAY].

Still Picture

1 Press [PLAY/PAUSE] during playback.

A still picture appears on the TV screen.

If a still picture vibrates vertically, stabilize it by using the [TRACKING +/-] buttons on the remote control.

If the DVD Recorder+VCR is left in Still mode for more than 5 minutes, the DVD Recorder+VCR will automatically enter Stop mode to protect the tape and video heads.

2 To return to normal playback, press [PLAY].

Slow Motion

1 Press [SLOW+] for Slow Motion playback.

2 Press [SLOW+] and [SLOW-] repeatedly to adjust the Slow Motion playback speed.

Counter Memory Function

This is useful if there is a section of tape you want to view immediately after recording or if you want to return to the same point several times.

1 Begin recording or playing a tape.

2 At the point you want to locate later, reset the real-time counter to 0:00:00 by pressing [CLEAR]. Continue to play or record.

3 Press [STOP] when recording or playback finishes.

4 You can make the tape automatically stop when the counter returns to about '0:00:00' by selecting "Go-to-Zero" function under 'SETUP' → 'Preferences' → 'VCR'. See page 27.

Audio CD/MP3 PLAYBACK

The DVD Recorder+VCR can play audio CDs and MP3 files on CD-ROM, CD-R or CD-RW discs.

- 1 Insert the CD disc and close the tray. The Audio CD or MP3 CD menu appears on the TV screen after a few moments to load the disc.
- 2 Use [▲▼] to select a track or a file, then press [PLAY] or [ENTER].

During playback, the current track's elapsed playing time will appear on the menu. Playback will stop at the end of the disc.

On the MP3 CD menu, you can display the folders on the disc.

Use [▲▼◀▶] to select the folder icon on the MP3 CD menu then press [ENTER] or [PLAY].

You can also display just the tracks in the folders.

Use [▲▼◀▶] to select a folder then press [ENTER].

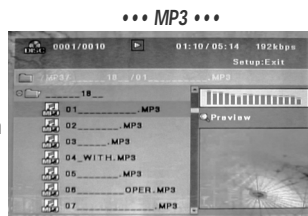

- 3 While playing an Audio CD, use [FF] or [REW] for 2X, 4X, 8X, 16X, 32X speed playback.
- 4 Use [PLAY/PAUSE] to pause playback while the disc is playing.
- 5 To stop playback at any time, press [STOP].

- Press [REPEAT] to repeat a track (file) and press again to repeat the whole disc.

JPEG / Kodak Picture CD PLAYBACK

The DVD Recorder+VCR can display JPEG files on CD-R/RW and Kodak Picture CDs.

- 1 Insert your CD and close the tray. The JPEG CD or Kodak Picture CD folder tree appears.
- 2 If there are folders which contain JPEG files (e.g., pictures on a Kodak Picture CD), select the desired folder using [▲▼◀▶] and press [ENTER].

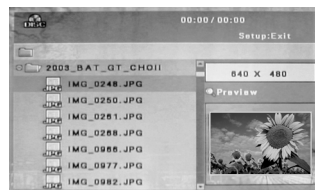

- 3 Select the thumbnail you want to display using [▲▼◀▶] and press [ENTER].
- 4 The full size image will be displayed and a slide show starts automatically with a time interval of 10 seconds.



- 5 Press [NEXT] or [PREV] to manually skip to the next or previous image.
- 6 Press [▶] (or [◀]) to rotate the image (counter) clockwise.
- 7 Press [STOP] to exit the slideshow.

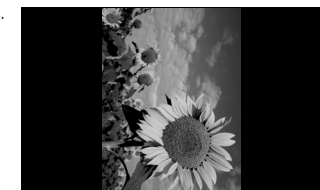

- When a CD contains both MP3 files and JPEG files, the default Play mode is JPEG image files.
- The DVD Recorder+VCR can playback up to 1000 files per disc.
- MP3 files encoded below 64kbps are not supported.

Playing MP3 Files During a Slide Show

You can enjoy a slide show while listening to MP3 music files.

- 1 Prepare a CD which includes both MP3 and JPEG files.
- 2 Insert the CD and play an MP3 file.
- 3 Press [TITLE] while playing the MP3 file to change the Play mode. The music playback will not stop.
- 4 Select an image file and press [ENTER] to start the slide show.
- 5 The MP3 file you selected continues to play during the JPEG slide show.

DivX PLAYBACK DivX model only

The DVD Recorder can play DivX files on CD-R/RW.

- 1 Insert the DivX disc and close the tray. The DivX Menu appears on the TV screen after a few moments to load the disc.
- 2 Use [▲▼] to select a file, then press [ENTER].
- 3 Press [FF] or [REW] during playback. The DVD Recorder will go into Search mode.
Press [FF] or [REW] to select the desired speed:
▶▶X8, ▶▶X16, ▶▶X32, ▶PLAY(forward) or ◀◀X8, ◀◀X16, ◀◀X32, ◀PLAY(backward)
- 4 Use [PLAY/PAUSE] to pause playback while the disc is playing.
- 5 Press [ZOOM] during Play mode to activate the Zoom function.
Each press of the [ZOOM] button changes the Zoom level as follow :X2 → X4 → 1 (normal size)
- 6 To stop playback at any time, press [STOP].

**SUBTITLES**

When the subtitles are not displayed provided although it has a file of subtitles:

- 1 Move to the Menu of DivX by pressing the [STOP] button.
- 2 Use [▲▼] to select a file of subtitles you want by using it.
- 3 Select the file of subtitles at that time by pressing the [ENTER] button.
- 4 After moving the file of DivX you want to play, play it by pressing the [ENTER] button.

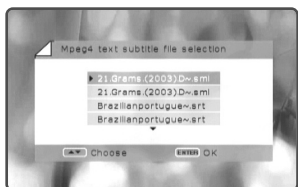

- DivX® is a high-quality video compression format for creating, editing, and distributing multimedia content. More than just a video technology, DivX is a global phenomenon that has become the new standard for digital video. Dubbed the "MP3 of video" for its remarkable compression and widespread popularity, DivX video enables anyone, anywhere to create and enjoy DVD-quality digital video.
- Playable MPEG 4 SP and ASP is DivX5.1, DivX5.05, DivX5.02, DivX4.1.2, DivX3.11, and Dr. DivX1.0.2.
- ASP does not support GMC & Qpel(Quarter Pixel).
- Playable bitrates is to max. 4MBPS.
- Playable frame number of screens per a second is 30, 25, 24, 12, and 8.
- Playable resolution is from Min. 200X100 to max. 720X576.
- Playable audio stream formats are MPEG I Layer III, MPEG II, PCM and AC-3.
- It may not be played according to a type of DivX files, a recording method, or a disc state. (The device was authenticated for DivX files from the DivX Networks, Inc. and it is available for playing a normal DivX but may be unavailable for playing the DivX files that have been manufactured with an illegal or abnormal Codec.)
- DivX, DivX certified and associated logos are trademarks of DivXNetworks, Inc. and are used under license.

Recording from TV

Follow the instructions below to record a TV program.

- 1 **Turn on the DVD Recorder+VCR and load a recordable disc or tape.**
Make sure your TV input is set to view the DVD Recorder+VCR.
- 2 **Set the desired Recording mode by pressing [REC MODE] repeatedly.**
DVD: HQ (High Quality - 1 hr/disc), SP (Standard Play - 2 hrs/disc), EP (Extended Play - 4 hrs/disc), or SEP (Super Long Play - 6 hrs/disc).
VCR: SP (Standard Play), LP (Long Play - 2 times SP)
- 3 **If your DVD Recorder+VCR does not show a TV program, press [INPUT] on the remote control. Use [PR+/-] to select the TV channel you wish to record.**
- 4 **Press [AUDIO] to select the audio channel to record (Stereo, BIL, or Mono).**

The table below shows what audio channel will be recorded with different settings and different types of broadcasts.

The last column (Monitor Audio) shows what you will hear during recording. For example, if the TV broadcast is in Stereo, then setting the DVD Recorder+VCR to Stereo will record the broadcast in Stereo, and the Monitor Audio will also be in Stereo.

TV Broadcast	Selected Audio	Broadcast Audio		Monitor Audio
		L Ch	R Ch	
MONO	MONO	MONO	MONO	MONO
STEREO	STEREO	L	R	STEREO
	MONO	MONO	MONO	MONO
BIL	BIL I	BIL I	BIL I	BIL I
	BIL II	BIL II	BIL II	BIL II

- 5 **Press [REC (●)] once.**
Recording will start. The REC indicator lights on the front panel display.
Recording continues until you press [STOP] or the disc is full.
To record for a fixed length of time, see One Touch Record on the next page.
 - 6 **Press [STOP (■)] to stop recording.**
- The maximum number of DVD titles per disc is 49. If the DVD Recorder+VCR is powered off during DVD recording, the recording will not be saved.
 - If a DVD+RW or unfinalized DVD+R disc is inserted in the tray, no title is played automatically after loading is finished.
 - If you are recording to a blank DVD+R (+RW) disc, it may take up to 7 minutes (it depends on disc) for post processing after recording.

One Touch Record (OTR)

One Touch Recording allows you add recording time in fixed increments at the touch of a button.

- 1 **Follow steps 1-4 under Recording from TV.**
- 2 **Press [REC (●)] repeatedly to set the length of the recording.**
Recording starts after the first press. Each subsequent press increases the recording time by 15 minutes (DVD) within the available space or 30 minutes (VCR, to a maximum of 10 hours). The recording time is displayed on the front panel display.

Checking the Recording Time

Total time and recorded time are displayed on the TV screen after pressing [DISPLAY]. Recorded time is displayed on the front panel display.

To Pause the Recording

- 1 Press [PLAY/PAUSE] to pause the disc or tape during recording.
- 2 When you want to continue recording, press [PLAY/PAUSE] or [REC (●)] in DVD mode and press [REC (●)] in VCR mode.



Note

- To quit One Touch Recording, press and hold [STOP] for 3 seconds.
- The DVD Recorder+VCR will automatically power off when One Touch Recording ends.

Tip (VCR mode only)

- Always use [PLAY/PAUSE] for best results when making changes during recording.
For example: To change channels during recording, first press [PLAY/PAUSE] to put the unit in Pause mode. Then select the desired channel on the DVD Recorder+VCR, and press [REC (●)] again to resume recording.



- You cannot record on the VCR deck and DVD deck at the same time.
- While the VCR is recording, DVD playback is possible. However, while the DVD is recording, all VCR functions are disabled.

One Touch Copy - DVD to VHS



If the DVD you are attempting to copy is copy-protected, you will not be able to copy the disc. It is not permitted to copy Macrovision encoded DVDs.

- 1 **Insert a Disc.**
Insert the disc you wish to copy in the DVD deck and close the disc tray.
- 2 **Insert a VHS Tape.**
Insert a blank VHS videotape into the VCR deck.
- 3 **Find the place on the DVD disc tape from which you want to start recording using the [PLAY/PAUSE], [FF] and [REW] functions. And press [STOP].**
- 4 **Press [VCR ◀ DVD] on the front panel.**
- 5 **Press [ENTER] to select the desired Record Mode in 'Copy to Tape' menu:**
 - SP (Standard Play)
 - LP (Long Play, 2 times SP).
- 6 **Press [VCR ◀ DVD] again to start copying.**
- 7 **Stop the Copy Process**

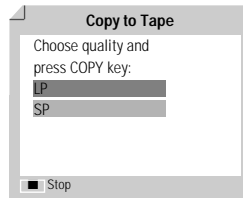

If you want to start copy any point of disc

1. Find the place on the DVD (or Disc) from which you want to start recording using the [PLAY/PAUSE], [REW] and [FF] functions.
2. Press [COPY] while DVD is in pause mode or in resume stop (|| STOP) mode.
3. Follow the same procedure 5-7.

Copy Edit (DVD → VCR)

During one touch copy you can search or change REC SPEED and resume copy.

- 1 During One Touch Copy, press [PLAY/PAUSE] to enter COPY EDIT mode.
- 2 Search with [FF/REW] or [NEXT/PREV] button.
- 3 Press [VCR ◀ DVD] and you can change REC SPEED.
- 4 Press [VCR ◀ DVD] again to resume copy.

One Touch Copy - VHS to DVD

You can copy the contents of a VHS tape to a DVD±R or DVD±RW. This allows you to archive your old VHS tapes to DVD.



If the VHS videotape you are attempting to copy is copy-protected, you will not be able to copy the tape. It is not permitted to copy Macrovision encoded tapes.

- 1 **Insert a VHS Tape.**
Insert the VHS videotape you wish to copy into the VCR deck.
 - 2 **Insert a DVD±R or DVD±RW disc.**
Insert a blank DVD±R or DVD±RW disc in the DVD deck and close the disc tray.
- When using a DVD+RW disc, you must initialize before copying; see page 47.
- 3 **Find the place on the VHS tape from which you want to start recording using the [PLAY/PAUSE], [FF] and [REW] functions. And press [STOP].**
 - 4 **Press [VCR ▶ DVD] on the front panel.**
 - 5 **Press [ENTER] to select the desired Record Mode in 'Copy to Disc' menu:**
 - HQ (High Quality - 1 hr/disc)
 - SP (Standard Play - 2 hrs/disc)
 - EP (Extended Play - 4 hrs/disc)
 - SEP (Very Low Quality - 8 hrs/disc)
 - 6 **Press [VCR ▶ DVD] again to start copying.**
 - 7 **Stop the Copy Process**
To stop copying at any time, press [STOP].
Copying will stop automatically when the VHS tape ends.

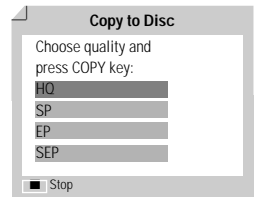

Timer Recording using Manual Set Record Screen

The Timer Recording function allows you to record up to 8 programs within a period of one month.

- 1 Insert recordable media such as DVD±R ,DVD±RW, recordable VHS tape.
- 2 Press [TIMER].
or Press [SETUP] and select 'Timer REC'. Then press [ENTER].

The 'Timer Recording' menu appears.

If you did not set the clock on the DVD Recorder+VCR, you must do so before programming a timer recording.

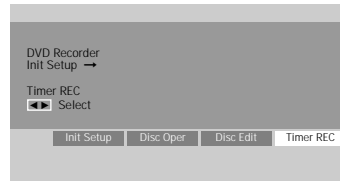

- 3 Select 'Manual' with [▲/▼] and confirm with [ENTER].

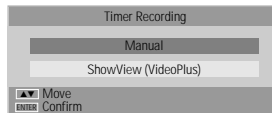

- 4 Use [▲/▼] to move to a timer recording slot, and press [ENTER] to modify it.

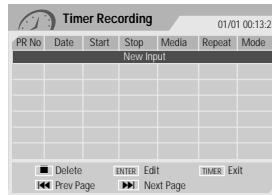

- 5 Enter the necessary information for your Timer Recording(s).

- PR No. – Choose the desired channel, or one of the external inputs from which to record.
- Date – Choose a date up to 1 month in advance, or select a daily or weekly program.
- Start – Set the recording start time.
- Stop – Set the recording end time.
- Repeat – Choose frequency of the recording. Once, Daily, Weekly, Weekday.
- Media - Choose desired media (DVD or VHS) using [▲▼].
- Title - Enter into title edit mode pressing [●].
- Mode – Choose a Record mode.
DVD: HQ, SP, EP or SEP VCR: SP, LP



[◀▶] – Moves the cursor left/right.

[▲▼] – Changes the setting at the current cursor position.

Press [SETUP] to exit the Timer Record menu.

Press [ENTER] to save the program after filling in all the program information.

- 7 Timer indicator will light or blinking. Power Off the DVD Recorder+VCR to start the Timer Recording.



- The Timer indicator lights on the front panel display when the DVD Recorder+VCR is ready for the Timer Recording.
- The DVD Recorder+VCR will record the audio according to the current TV tuner setting (Stereo, Mono or SAP). Use the [AUDIO] button to set the audio before switching the DVD Recorder+VCR to Standby mode.
- The DVD Recorder+VCR will automatically power off when the Timer Recording ends.
- There is a short delay when a timer recording finishes to confirm the recorded program. If two timer recordings are set to record sequentially (one right after the other), the very beginning of the later program may not be recorded.

Timer Recording using ShowView (VideoPlus) system

Thanks to this programming system, you no longer need to tediously enter the date, programme number, start and end time. All the information needed by the DVD Recorder+VCR for programming is contained in the ShowView (VideoPlus) programming number. This ShowView (VideoPlus) number is found in most TV listings.

- 1 Insert recordable media such as DVD±R ,DVD±RW.

- 2 Press [TIMER].

or Press [SETUP] and select 'Timer REC'. Then press [ENTER].

The 'Timer Recording' menu appears.

- 3 Select 'ShowView (VideoPlus)' with [▲/▼] and confirm with [ENTER].

The 'ShowView (VideoPlus)' menu appears.

Enter the entire 'ShowView (VideoPlus)' number. This number is up to 9 digits long and can be found next to the start time of the TV programme in your TV listings magazine.

e.g.: 5-234-89 or 5 234 89

Enter 523489 for the 'ShowView (VideoPlus)' number.

- 4 Press [ENTER] to confirm.

- 5 The decoded information appears after confirmation. You can change the information by selecting the appropriate input field using [▲▼]. If required, change the information using [▲▼].

If all the information is correct, press the [ENTER] button. The programming information is stored in a TIMER block.

- 6 Press [SETUP] to exit the Timer Record List.

- 7 Timer indicator will light or be blinking. Power Off the DVD Recorder+VCR to start the Timer Recording.



- ShowView (VideoPlus) is not available in some countries.
- ShowView (VideoPlus) is a trademark applied for by Gemstar Development Corp. The ShowView (VideoPlus) system is manufactured under license from Gemstar Development Corporation.

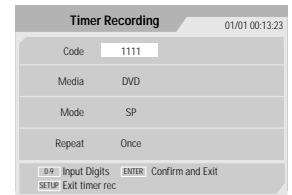
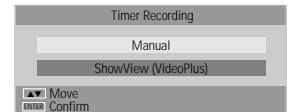

Canceling a Timer Recording

You can clear a Timer Recording any time before the recording actually starts.

- Use [▲▼] to select the program you want to erase on the Timer Recorder List. Press [■STOP] to delete the program.

Stopping a Timer Recording in Progress

After a Timer Recording has started, you can still cancel the program by pressing and holding [■STOP] for 3 seconds.

Timer Recording Troubleshooting

Even if a Timer Recording is set, the DVD Recorder+VCR will not record if:

- No disc is loaded.
- A non-recordable disc is loaded.
- Disc is protected in the 'Disc Operation' menu; see page 47.
- There are already 49 titles recorded on the disc.

You cannot enter a Timer Recording if:

- A recording is already under way.
- The start time has already passed.
- Eight Timer Recordings have already been set.

If two or more Timer Recordings overlap:

- You should set only one Timer Recording.
- You can choose replace old Timer Recording or not.
- Only one Timer recording will work.

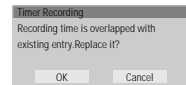

Confirmation is not possible when:

- Disc is protected in the 'Disc Operation' menu; see page 47.
- There are already 49 titles recorded on the disc.

If the disc is damaged, the recording may not complete successfully, even if the Check field shows 'Rec. OK'.

Recording from External Components

You can record from an external component, such as a camcorder or VCR, connected to any of the DVD Recorder+VCR's external inputs.

- 1 Make sure the component you want to record from is connected properly to the DVD Recorder+VCR; see pages 11 and 14.**
- 2 Use [▲▼] or [INPUT] to select the external input to record from.**
- 3 Load a recordable disc or tape.**
- 4 Set the desired Recording mode by pressing [REC MODE] repeatedly.**
DVD: HQ (High Quality - 1 hr/disc), SP (Standard Play - 2 hrs/disc), EP (Extended Play - 4 hrs/disc), SEP (Very Low Quality - 8 hrs/disc)
VCR: SP (Standard Play), LP (Long Play - 2 times SP)
- 5 Press [REC (●)] once.**
Recording will start. The REC indicator lights on the front panel display. Recording continues until you press [STOP] or the disc is full. To record for a fixed length of time, see 'One Touch Record' on page 39.
- 6 Press [STOP (■)] to stop recording.**



Note

If your source is copy-protected, you will not be able to record it using the DVD Recorder+VCR. See 'Copyright Notice' on page 4 for more details.

Recording from a Digital Camcorder

DV model only

You can record from a digital camcorder connected to the DV IN jack on the front panel of the DVD Recorder+VCR.

You can use the DVD Recorder+VCR remote to control both the camcorder and the DVD Recorder+VCR. Before recording, make sure the digital camcorder is properly connected to the front panel DV IN jack; see page 14.



The source signal must be DVC SD format.

Some camcorders cannot be controlled using the DVD Recorder+VCR remote.

If you connect a second DVD recorder using a DV cable, you cannot control the second recorder from this one.

You cannot control the DVD Recorder+VCR remotely from a component connected to the DV IN jack.

You cannot record date and time information from a DV cassette.

- 1 Make sure your digital camcorder is connected to the front panel DV IN jack; see page 14.**
- 2 Press [INPUT] repeatedly to select the DV input.**

DV appears on the front panel display and the TV screen.

- 3 Find the place on the camcorder tape from which you want to start recording.**

For best results, pause playback at the point you want to start recording. Depending on your camcorder, you can use the DVD Recorder+VCR remote to control the camcorder using the STOP, PLAY, and PAUSE functions.

- 4 Press [REC] once to start recording.**

Recording is automatically stopped if the DVD Recorder+VCR detects no signal. You can pause or stop the recording by pressing [PLAY/PAUSE] or [STOP]. You cannot control the camcorder from the remote control during recording.

What is DV? *DV model only*

Using DV, also known as i.LINK, you can connect a DV-equipped camcorder to the DVD Recorder+VCR using a single DV cable for input and output of audio, video, data and control signals.

The i.LINK interface is also known as IEEE 1394-1995.

"i.LINK" and the "i.LINK" logo are trademarks.

- The DVD Recorder+VCR is only compatible with DV-format (DVC-SD) camcorders. Digital satellite tuners and Digital VHS video recorders are not compatible.
- You cannot connect more than one DV camcorder at a time to the DVD Recorder+VCR.
- You cannot control the DVD Recorder+VCR from external equipment connected via the DV IN jack (including two DVD Recorders).
- It may not always be possible to control the connected camcorder via the DV IN jack.
- Audio input to the DV IN jack should be 32 or 48kHz (not 44.1kHz).
- Picture disturbance on the recording may occur if the source component pauses playback or plays an unrecorded section of tape, or if the power fails in the source component, or if the DV cable becomes disconnected.

Disc Initialize

- If you load a blank DVD±R (±RW) disc, it will be initialized (formatted to enable recording).
- Do not start recording until disc initialization is complete.
- If you load a DVD±RW that has already been used you can record a program immediately.

Disc Operation in DVD±RW disc

For recordable DVD media, such as DVD±R and DVD±RW discs, you can manage the disc using the Disc Menu. The DVD±RW Disc Menu allows you to erase, lock, or unlock your disc. You can also make it compatible with most other DVD players.

At first, go to Disc Operation mode.

- 1 Press [SETUP]. The Setup menu appears.
- 2 While 'Disc Oper' is selected, press [ENTER] to go to the Disc Operation page.

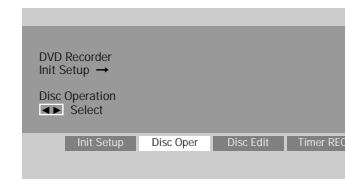
**Erase the disc (DVD±RW)**

- 3 Use [▲/▼] to select the 'Erase' menu.
- 4 If you want to erase the whole disc, press [ENTER].
- 5 To confirm, select 'OK'. To cancel, select 'Cancel'.

If you select 'OK' and press [ENTER], all the contents of the disc will be lost.

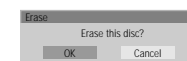
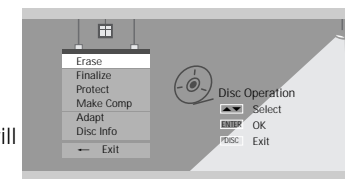
**Protect Disc (DVD±R, DVD±RW)**

If you want to protect a disc from accidental recording, editing, or erasing, you can lock the disc. Later, if you change your mind, you can unprotect the disc.

- 3 Use [▲/▼] to select 'Protect' menu.
- 4 If you want to protect the whole disc, press [ENTER].
- 5 To confirm, select 'OK'. To cancel, select 'Cancel'.

If you select 'OK' and press [ENTER], all the contents of the disc will be protected.

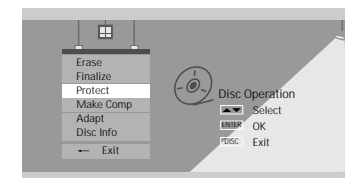

Make Compatible (DVD±RW)

'Make Compatible' for a DVD±RW will automatically create a menu screen for navigating the disc. This menu screen is accessible by pressing [MENU] or [TITLE].

- 3 Press [▲/▼] to select 'Make Compatible'.
- 4 If you want to make the disc compatible, press [ENTER].
- 5 To confirm, select 'OK'. To cancel, select 'Cancel'.

If you select 'OK' and press [ENTER], your disc will be made compatible.

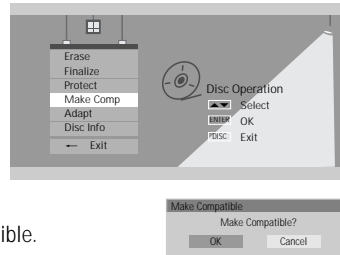

- 'Make Compatible' can take up to 3-4 minutes depending on the type of disc, how much is recorded on the disc, and the number of titles on the disc.
- If you do not make your DVD±RW disc compatible, your edits will not be recognized by other DVD players.

Adapt

DVD recordings from different manufacturers have their unique Disc menu structure. When a recordable DVD disc is recorded in another brand DVD recorder, the Disc has a different Disc menu structure from DAEWOO DVD recorders. So, the Disc menu should be changed to DAEWOO Disc menu to be compatible with DAEWOO DVD Recordings. It is called Adapt function. After Adapt function is completed, recorded title contents are exactly the same, but only Disc menu is changed.

- 3 Use [▲/▼] to select 'Adapt' menu.
- 4 If you want to adapt the whole disc, press [ENTER].
- 5 To confirm, select 'OK'. To cancel, select 'Cancel'.

If you select 'OK' and press [ENTER], the disc will be adapted.

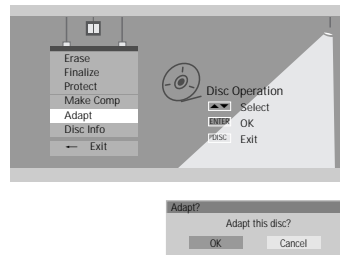

Information

- 3 Press [▲/▼] to select 'Disc Info'.
- 4 The Disc Info Menu shows you disc information, such as disc type, number of recordings, total titles, free space, etc.

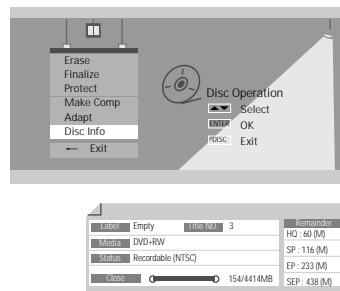

Disc Operation in DVD±R, DVD-RW disc

For recordable DVD media, such as DVD±R and DVD±RW discs, you can manage the disc using the Disc Menu. The DVD±R, DVD-RW Disc Menu allows you to rename your disc or finalize it so it will be compatible with most other DVD players.

At first, go to Disc Operation mode.

- 1 Press [SETUP]. The Setup menu appears.
- 2 While 'Disc Oper' is selected, press [ENTER] to go to the Disc Operation page.

Finalize (DVD±R, DVD-RW)

Finalizing a DVD±R, DVD-RW 'locks' its recordings in place so the disc can be played on most standard DVD players or computers equipped with DVD-ROM drives.

- 3 Use [▲/▼] to select 'Finalize' menu.
- 4 If you want to finalize the whole disc, press [ENTER].
- 5 To confirm, select 'OK'. To cancel, select 'Cancel'.

If you select 'OK' and press [ENTER], the disc will be finalized.

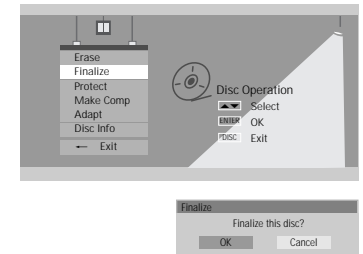

- Once you have finalized a DVD±R, DVD-RW disc, you cannot edit or record anything else on that disc.
- It may take over 7 minutes for finalizing the edited disk, you'd better wait till the set finishes the finalising operation.
- 'Finalize' can take up to 3-4 minutes depending on the type of disc, how much is recorded on the disc, and the number of titles on the disc.

Title Menu

You can manage the titles on your DVD±R/±RW discs using the Title menu.

At first, go to **Disc Edit mode**.

- 1 Press [SETUP]. The Setup menu appears.
- 2 While 'Disc Edit' is selected, press [ENTER] to go to the Disc Edit page.

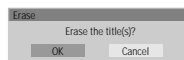
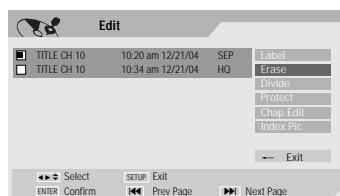
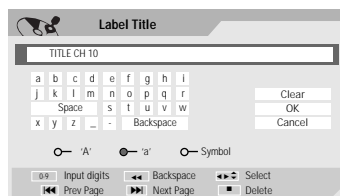
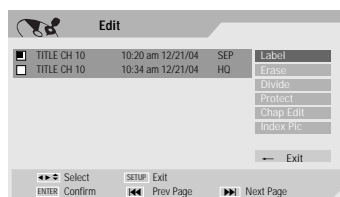
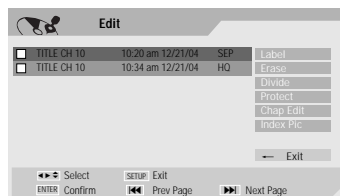
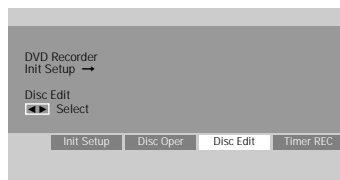

Label a Title

To change the name of a title:

- 2 Select the title to be labelled using [ENTER].
- 3 Select 'Label' using [▲ ▼].
- 4 Press [ENTER] to change the title name.
- 5 The Keyboard Menu will be displayed. Use [◀ ▶ ▲ ▼] to select a character or function and press [ENTER].
- 6 After the new title name is complete, select 'OK' and press [ENTER].

Erase a Title

- 2 Select the title to be erased using [ENTER].
- 3 Then select 'Erase' using [▲ ▼].
- 4 Press [ENTER] to erase the title.
- 5 Select 'OK' and press [ENTER] to confirm.
- 6 The Erase Title progress bar will be displayed. This may take several seconds.
- 7 After erasing is complete, the erased title remains as an empty title.



You can erase titles on DVD±RW discs only.

Divide (DVD±RW)

This feature allows you to divide a title into two titles.

- 2 Select the title to be divided using [ENTER].
- 3 Select 'Divide' using [▲ ▼].
- 4 Press [ENTER] to divide the title.
- 5 Select 'OK' and press [ENTER] to confirm.
- 6 Press [ENTER] when the preferred picture is on your TV screen.
- 7 It may take a few minutes to divide the title.

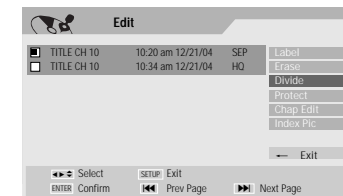

Protect

If you want to protect a title from accidental recording, editing, or erasing, you can lock the title. Later, if you change your mind, you can unprotect the title.

- 2 Select the title to be protected using [ENTER].
- 3 Select 'Protect' using [▲ ▼].
- 4 Press [ENTER] to protect the title.
- 5 Select 'OK' and press [ENTER] to confirm.
- 6 The Protect Title progress bar will be displayed. This may take several seconds. The Protect icon '☐' will appear in front of Title name.

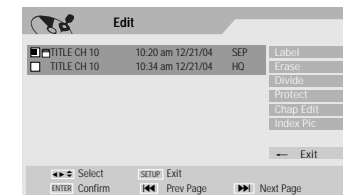
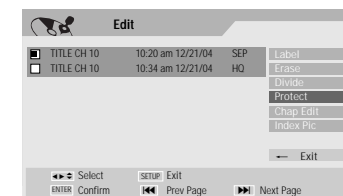

Edit Chapters

- Select the title to be edited using [ENTER].
- Select 'Chap Edit' using [▲ ▼].
- Press [ENTER] to edit the chapters.
- Select 'OK' and press [ENTER] to confirm.
- The Chapter Edit Menu will be displayed. Use [◀▶▲▼] to select one of the various chapter marker functions (Add, Delete, or Hide).
- Press [ENTER] to confirm.

Add/Delete a Marker

You can add a chapter marker anywhere in a title during playback. Once the chapter is marked, you can use the chapter search feature as described above.

You can add/delete chapter markers or delete all chapter markers in a title.

Hide Chapters

This feature allows you to hide or unhide a chapter. After hiding a chapter, the chapter is not deleted but only hidden. If a chapter is hidden then it shows 'Unhide Chapter' and vice versa.

Change Index Picture

Each title displayed in the Playlist menu is represented by a thumbnail picture taken from the start of that title or chapter. If you prefer, you can select a different still picture from within the title.

- Select the title to be edited using [ENTER].
- Select 'Index Pic' using [▲ ▼].
- Press [ENTER] to change the index picture.
- Press [ENTER] when the preferred picture is on your TV screen.

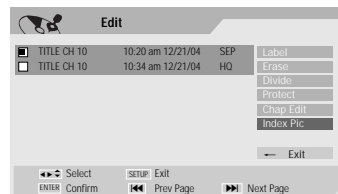
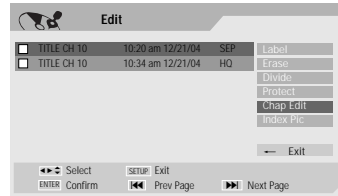

Check the following guide for the possible cause of a problem before contacting customer support.

Symptom	Cause	Solution
No power.	The power cord is disconnected.	Plug the power cord into the wall outlet securely.
No picture.	The TV is not set to receive DVD Recorder+VCR signal output.	Select the appropriate video input on the TV so the picture from the DVD Recorder+VCR appears on the TV screen.
	The video cable is not connected	Connect the video cable securely.
	The TV power is turned off.	Turn on the TV.
No sound.	The equipment connected with the audio cable is not set to receive DVD Recorder+VCR signal output.	Select the correct input mode on the audio receiver so you can listen to the sound from the DVD Recorder+VCR.
	The audio cables are not connected	Connect the audio cables securely.
	The power on the equipment connected with the audio cable is turned off.	Turn on the equipment connected with the audio cable.
	The audio cables are damaged.	Replace with new ones.
Playback picture is poor.	The disc is dirty.	Clean the disc.
	Tape heads are dirty.	Clean the video heads.
	Tape is a rental or was recorded on another VCR.	Use [Tracking +/-] for manual tracking adjustment while a tape is playing.
DVD Recorder+VCR does not start playback.	No disc is inserted.	Insert a disc or tape. (Check that the disc indicator on the front panel display is lit.)
	An unplayable disc is inserted.	Insert a playable disc. (Check the disc type, colour system, and regional code.)
	The disc is placed upside down.	Place the disc with the playback side down.
	The disc is not placed within the guide.	Place the disc on the disc tray correctly inside the guide.
	The disc is dirty.	Clean the disc.
	The Parental Control level is set.	Cancel the Parental Control function or change the rating level.
Picture from external input is distorted.	The video signal from the external component is copy-protected.	You cannot connect via the DVD Recorder+VCR. Connect the component directly to your TV.
Some channels are skipped over when using [PR+/-].	The skipped channels were deleted with the 'Adjust Channels' menu.	Use the 'Auto Scan' menu to restore channels. See 'Auto Scan' on page 19.
Picture or sound of broadcasting channel is weak or missing.	Antenna or cables are loose.	Tighten connections or replace cable.
	Wrong Tuning Band is selected in the DVD Recorder+VCR Setup menu.	Try all 'Tuning Band' options; see page 17 for details.
Camcorder image not shown.	Camcorder is off.	Turn camcorder on and operate properly.
Camcorder image via A/V input to DVD Recorder+VCR is not shown on TV screen.	DVD Recorder+VCR's source is not set to AV1, AV2 or AVF.	Use [INPUT] to select AV input channel (AV1, AV2 or AVF).

Symptom	Cause	Solution
Can't play disc recorded on this DVD Recorder+VCR on another DVD player.	The disc was not finalized (or not made compatible if using a DVD+RW).	Finalise the disc; see page 49.
	Some players will not play even a finalized disc.	No solution.
	Discs recorded with copy-once material cannot be played on other players.	No solution.
Cannot record or did not record successfully.	The remaining blank space on the disc is insufficient.	Use another disc.
	The source you are trying to record is copy-protected.	You cannot record the source.
	When setting the recording channel, the channel is tuned on your TV's tuner.	Select the channel on the DVD Recorder+VCR's built-in TV tuner.
Timer Recording not possible.	Clock in DVD Recorder+VCR is not set to correct time.	Set clock to correct time. See 'Set Clock' on page 19.
	Timer has been programmed incorrectly.	Reprogram Timer. See 'Timer Recording' on page 42-44.
	TIMER indicator light does not appear after programming timer.	Reprogram Timer.
Stereo Audio Record and/or Playback not present.	TV is not Stereo-compatible.	No solution.
	Broadcast program is not in stereo format.	No solution.
	DVD Recorder+VCR A/V Out jacks are not connected to TV A/V In jacks.	Make A/V connections. Stereo is available only via A/V output from DVD Recorder+VCR.
	DVD Recorder+VCR Audio/Video Out is not selected for viewing at the TV.	Select AUX or A/V source as TV input. Set TV audio channel mode to Stereo.
	DVD Recorder+VCR's TV audio channel is set to BIL or MONO.	See 'Changing the TV Audio Channel' on page 31.
Remote control does not work properly.	The remote control is not pointed at the remote sensor of the DVD Recorder+VCR.	Point the remote control at the remote sensor of the DVD Recorder+VCR.
	The remote control is too far from the DVD Recorder+VCR.	Operate the remote control within 23 ft (7m).
	There is an obstacle in the path of the remote control and the DVD Recorder+VCR.	Remove the obstacle.
	The batteries in the remote control are dead.	Replace the batteries.

Moisture Condensation

Moisture condensation can occur:	In locations where moisture condensation may occur:
When the DVD Recorder+VCR is moved from a cold place to a warm place.	Keep the DVD Recorder+VCR plugged into an AC power outlet with the power on. This will help prevent condensation.
Under extremely humid conditions.	When condensation has occurred, wait a few hours for the DVD Recorder+VCR to dry before using it.

Technical Specifications

General

Power requirements 200-240V,50/60Hz
Power consumption Maximum 26W (Stand-by :3.7W)
Dimensions (approx.) 430 *92 *312 (w*h*d)
Mass (approx.) 4.96 Kg
Operating temperature 5°C to 35°C
Operating humidity 5% to 90%
Signal system PAL

Recording

Recording formats DVD Video Recording, DVD-VIDEO
Recordable discs DVD+R, DVD+RW, DVD-R, DVD-RW
Recordable time [DVD] Approx 1 Hour (HQ mode), 2 Hours (SP mode), 4 Hours (EP mode), 8 Hours (SEP mode)
[VCR] SP: 3 Hours (E-180), LP : 6 Hours (E-180)

Video recording format

Sampling frequency 27MHz
Compression format MPEG 2

Audio recording format

Sampling frequency 48kHz
Compression format MPEG1 Layer2

VCR Specifications

Head system 4 Head Video, 2 Head Hi-Fi helical scan azimuth system
Timer 24-hour display type
Tape speed SP: 23.39 mm/sec, LP: 11.70 mm/sec
Tape width 12.7 mm
Rewind time less than 150 sec (E-180)
Channel coverage VHF:2-12,13-20,74-80 / UHF:21-69 / CATV:1-41
Frequency range 20Hz to 20kHz
Signal-to-noise ratio 43 dB
Dynamic range 75 dB
Channel separation 45 dB

DVD Specifications

Laser system Semiconductor laser, wavelength 650 nm

Frequency response DVD (PCM 48 kHz): 8 Hz to 22 kHz, CD: 8 Hz to 20 kHz
Video S/N More than 60dB
Audio S/N More than 90dB
Harmonic distortion Less than 0.06%
Dynamic range More than 90 dB
Resolution over 500 lines (HQ Recording)

Inputs

ANTENNA IN Antenna or CATV input, 75 Ω
VIDEO IN 1.0 Vp-p 75 Ω , sync negative, RCA jack x 2
AUDIO IN -8.8 dBm more than 47 k, RCA jack (L, R) x 2
DV IN (Optional) 4 pin (i.LINK/IEEE 1394 standard)

Outputs

VIDEO OUT Composite output (1.0 Vp-p, unbalanced) RGB output (75 in load, R:0.7Vp-p, G:0.7Vp-p, B:0.7Vp-p)
S-VIDEO OUT (Y) 1.0 V (p-p), 75 Ω , negative sync, Mini DIN 4-pin x 1, (C) 0.286 V (p-p) 75 Ω
COMPONENT VIDEO OUT (Y) 1.0 V (p-p), 75 Ω , negative sync, RCA jack x 1 (Pb)/(Pr) 0.7 V (p-p), 75 Ω , RCA jack x 2
AUDIO OUT Digital audio : 0.5 V (p-p), 75 Ω , RCA jack x 1
Analog audio : 1.1 Vrms (1 kHz, -6 dB), 600 Ω , RCA jack (L, R) x 2
CH.52 (default)
RF OUT

Accessories

Scart cable (Only for france)1
RF Coaxial Cable 1
Blank DVD+RW disc 1
Remote control 1
Batteries 2

Design and specifications are subject to change without notice.

Manufactured under license from Dolby Laboratories. 'Dolby' and the double-D symbol are trademarks of Dolby Laboratories.
DTS and DTS Digital Out are registered trademarks of Digital Theater Systems, Inc.

Macrovision

This product incorporates copyright protection technology that is protected by method claims of certain U.S. patents and other intellectual property rights owned by Macrovision Corporation and other rights owners. Use of this copyright protection technology must be authorized by Macrovision Corporation, and is intended for home and other limited viewing uses only unless otherwise authorized by Macrovision Corporation. Reverse engineering or disassembly is prohibited.

Free Manuals Download Website

<http://myh66.com>

<http://usermanuals.us>

<http://www.somanuals.com>

<http://www.4manuals.cc>

<http://www.manual-lib.com>

<http://www.404manual.com>

<http://www.luxmanual.com>

<http://aubethermostatmanual.com>

Golf course search by state

<http://golfingnear.com>

Email search by domain

<http://emailbydomain.com>

Auto manuals search

<http://auto.somanuals.com>

TV manuals search

<http://tv.somanuals.com>