

DAEWOO

MICROWAVE CONVECTION/GRILL OVEN

KOC-621Q

OWNER'S
MANUAL

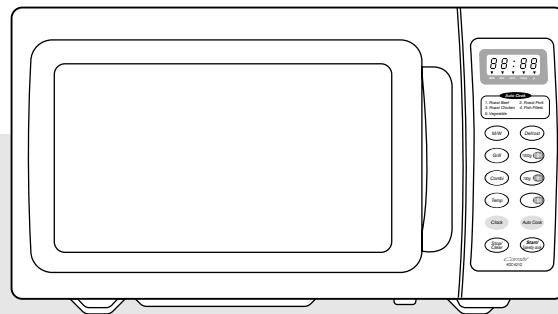

Helpline number: 01189 252627

Before operating this oven, please read these manual completely.

PRECAUTIONS TO AVOID POSSIBLE EXPOSURE TO EXCESSIVE MICROWAVE ENERGY

- (a) **Do not attempt to operate this oven with the door open** since open-door operation can result in harmful exposure to microwave energy. It is important not to defeat or tamper with the safety interlocks.
- (b) **Do not place any object** between the oven front face and the door or allow soil or cleaner residue to accumulate on sealing surfaces.
- (c) **WARNING** : If the door or door seals are damaged, the oven must not be operated until it has been repaired by a trained person: (1) door (bent), (2) hinges and latches (broken or loosened), (3) door seals and sealing surfaces.
- (d) **WARNING** : It is hazardous for anyone other than a trained person to carry out any service or repair operation which involves the removal of any cover which gives protection against exposure to microwave energy.
- (e) **WARNING** : Liquids or other foods must not be heated in sealed containers since they are liable to explode.
- (f) **WARNING** : Only allow children to use the oven without supervision when adequate instructions have been given so that the child is able to use the oven in a safe way and understands the hazards of improper use.

TABLE OF CONTENTS

INSTALLATION AND EARTHING INSTRUCTIONS	2
IMPORTANT SAFETY INSTRUCTIONS.....	3
WHICH UTENSILS CAN BE USED IN THE OVEN?.....	4
CONTROL PANEL	5
ACCESSORIES.....	6
BEFORE OPERATION.....	7
SETTING THE CLOCK	7
CHILD LOCK AND POWER SAVE MODE	7
OPERATION	8
MICROWAVE COOKING	8
GRILL COOKING	9
OVEN COOKING (traditional cooking)	9
OVEN COOKING (with pre-heat)	10
COMBINATION COOKING	11
DEFROST	11
AUTO COOK	12
SPEEDY COOK	13
TO STOP THE OVEN WHILE THE OVEN IS OPERATING	13
ABNORMAL MESSAGE.....	13
GENERAL GUIDELINES.....	14
KEEP THE OVEN CLEAN.....	15
BEFORE CALLING FOR SERVICE	16
QUESTIONS AND ANSWERS.....	17
SPECIFICATIONS.....	17

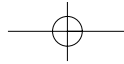

INSTALLATION AND EARTHING INSTRUCTIONS

How to examine your microwave oven after unpacking.

Unpack oven, remove all packing material, and examine the oven for any damage such as dents, broken door, latches or cracks in the door. Do not remove the film from inside the door. Notify dealer immediately if the oven is damaged. Do not install if the oven is damaged.

Where to place your microwave oven.

1. Place the oven on a flat and stable surface.
2. Surface of the oven is protected by a plastic film which should be removed before using.
3. Leave space behind and sides and upper of the oven. All air vents should be kept a clearance.
If all vents are covered during operation, the oven may overheat and, eventually, lead to oven failure.
4. Keep away from radio and TV sets. If the oven is located close to a TV, radio interference may result.
5. Keep away from heating appliances and water taps. Keep the oven away from hot air, steam or splash when choosing a place to position it, or the insulation might be adversely affected and breakdowns occur.
6. The minimum height of free space necessary above the top surface of the oven is minimum 170mm.

Prior to use (If your oven has a grill element)

In order to protect your oven during transportation and storage, the grill element is covered with a protective coating. To remove this coating the grill element must be heated for 5 minutes. This procedure will produce some bad odours as the protective coating on the element disappears.

To remove the coating, use the following procedures:

1. Place an overproof and microwave safe bowl, containing 200cc of water or more, in the oven.
2. Press the convection button.
3. Set the time to 5 minutes.
4. Press the start button.
5. When the 5 minutes has elapsed, an acoustic signal sounds.

Note:

The protective coating has now been removed and the oven is ready to use. Please be aware that your oven now is very hot.

6. Open the oven door and remove the bowl with water (use oven gloves when removing the bowl).

CHILD LOCK

To prevent child from operating the oven, install the childlock key.

1. Touch stop/clear button for 3 seconds.
The oven will beep and all buttons do not operate.
2. Touch stop/clear button for 3 seconds once again, then childlock is cancelled.

- **WARNING:** Only allow children to use the oven without supervision when adequate instructions have been given so that the child is able to use the oven in a safe way and understands the hazards of improper use.

Electrical Connection

WARNING-THIS APPLIANCE MUST BE EARTHED.

REFER TO RATING PLATE FOR VOLTAGE AND CHECK THAT THE APPLIANCE VOLTAGE CORRESPONDS WITH THE SUPPLY VOLTAGE IN YOUR HOME.

The flexible mains lead must be correctly connected, as below, to a three pin plug of not less than 13 AMP capacity. You must use a 3 pin plug which should be marked with the number BS 1363 and it should be fitted with 13 AMP fuse marked with the number BS 1362.

We recommend the use of good quality plugs and wall sockets that can be switched off when the machine is not in use.

IMPORTANT-The wires in the mains lead fitted to this appliance are coloured in accordance with the following code

GREEN AND YELLOW-EARTH
BLUE-NEUTRAL
BROWN-LIVE

As the colour of the wires in the mains lead of this appliance may not correspond with the coloured markings identifying the terminals in your plug, proceed as follows:

Power supply

- Check your local power source. This oven requires a current of approximately 12(8)amperes, 230V 50Hz.
- Power supply cord is about 1.2 meters long.
- The voltage used must be the same as specified on this oven. Using a higher voltage may result in a fire or other accident causing oven damage. Using low voltage will cause slow cooking. We are not responsible for damage resulting from use of this oven with a voltage of ampere fuse other than those specified.
- If the supply cord is damaged, it must be replaced by the manufacturer or its service agent or a similarly qualified person in order to avoid a hazard.

The wire which is coloured GREEN AND YELLOW must be connected to the terminal in the plug which is marked with the letter "E" or the earth symbol \perp or coloured GREEN AND YELLOW, or GREEN.

The wire which is coloured BLUE must be connected to the terminal which is marked with the letter "N" or coloured BLACK, or BLUE.

The wire which is coloured BROWN must be connected to the terminal which is marked with the letter "L" or coloured RED, or BROWN.

If the terminals in the plug are unmarked or you are in any doubt as to the correct connections, consult a qualified electrician.

If you do not make the proper electrical connections you will damage your microwave oven and possibly injure yourself. Neither the manufacturer nor the supplier are liable if this happens.

MOULDED PLUGS

Should it be necessary to remove a moulded on plug from the mains cable, it should be cut off and replaced with a suitable replacement.

The moulded plug cannot be used for any other appliance, therefore remove the fuse and dispose immediately and safely to prevent anyone, especially children from plugging it in to a wall socket, which will create a safety hazard.

Should the mains lead ever require replacement, it is essential that this operation be carried out by a qualified electrician and should only be replaced with a flexible cord obtained from the manufacturer.

Applicable only if moulded plug is fitted.

After replacement of a fuse in the plug, the fuse cover must be refitted. If the fuse cover is lost, a replacement cover is obtained. The colour of the correct replacement fuse cover is that of the coloured insert in the base of the plug or the colour that is embossed in words in the base of the plug recess or elsewhere on the plug. Always state this colour when ordering a replacement fuse cover.

Only 13 amp replacement fuses which are ASTA approved to BS 1362 should be fitted

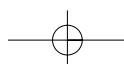

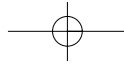

IMPORTANT SAFETY INSTRUCTONS

When using electrical appliances, basic safety precautions should be followed, including the following:

WARNING-To reduce the risk of burns, electric shock, fire, injury to persons or exposure to excessive microwave energy:

1. Read all instructions before using the appliance.
2. Read and follow the specific "PRECAUTIONS TO AVOID POSSIBLE EXPOSURE TO EXCESSIVE MICROWAVE ENERGY", found on page 1.
3. This appliance must be earthed. Connect only to a properly installed wall socket.
4. Install or locate this appliance only in accordance with the provided installation instructions.
5. Some products such as whole eggs and sealed containers for example, closed glass jars-may explode and should not be heated in this oven.
6. Use this appliance only for its intended use as described in this manual.
7. As with any appliance, close supervision is necessary when used by children.
8. Do not operate this appliance if it has a damaged cord or plug, if it is not working properly, or if it has been damaged or dropped.
9. This appliance should be serviced only by qualified service personnel. Contact the nearest authorized service facility for examination, repair or adjustment.
10. Do not cover or block any openings on this appliance.
11. Do not use outdoors.
12. Do not immerse cord or plug in water.
13. Keep cord away from heated surfaces.
14. Do not let cord hang over edge of table or counter.
15. When cleaning surfaces of door and oven that meet when the door closes, use only mild, nonabrasive soaps or detergents with a sponge or soft cloth.
16. To reduce the risk of fire in the oven cavity:
 - (a) Do not overcook food. Carefully attend appliance if paper, plastic, or other combustible materials are placed inside the oven when cooking food.
 - (b) Remove wire twist-ties from bags before placing bag in oven.
 - (c) If materials inside the oven should ignite, keep oven closed, turn oven off, and disconnect the power cord, or shut off power at the fuse or circuit breaker panel.
17. Do not use this appliance to heat corrosive chemicals (for example, sulfides and chlorides). Vapours from such corrosive chemicals may erode the contacts and springs of the safety interlock switches and render them inoperable.
18. The contents of feeding bottles and baby jars must be stirred or shaken and the temperature is to be checked before consumption to avoid burns.
19. The appliance must be positioned so that the plug is accessible.

ARCING

If you see arcing, press **STOP/CLEAR** button and correct the problem.

Arcing is the microwave term for sparks in the oven. Arcing is caused by:

- Metal or foil touching the side of the oven.
- Foil not molded to food (upturned edges act like antennas).
- Metal, such as twist-ties, poultry pins, or gold rimmed dishes, in the microwave.
- Recycled paper towels containing small metal pieces being used in the microwave.

General Use

Listed below are, as with all appliances, certain rules to follow and safeguards to assure top performance from this oven:

1. Do not use the oven for any reason other than food preparation, such as for drying clothes, paper, or any other nonfood items or for sterilizing purposes. They may catch on fire.
2. Do not use the oven when empty, this could damage the oven.
3. Do not use the oven cavity for any type of storage, such as papers, cookbook, cookware, etc.
4. Do not operate the oven without the turntable tray in place. Be sure it is properly sitting on the rotating base.
5. Cautious when removing the turntable tray after cooking meats that may have caused an accumulation of grease in the tray.
6. Unlike microwave-only ovens, this oven may become hot on the cabinet and oven door. Always use hot pads or oven mitts when placing or removing food and/or accessories from the oven. Cautious about touching parts other than control panel during or immediately following grill or combination cooking.
7. If the oven is hot from combination cooking, do not use plastic or Styrofoam cookware for microwave cooking. They may melt.
8. Do not use recycled paper products for cooking. They may contain impurities which could cause sparks and/or fires when used during cooking.
9. Do not continue to cook with metal utensils if sparking appears. See "Accessories" section on page 6 for proper use of cookware.
10. Do not leave the oven unattended during short cooking times. Overcooking and fire may result.
11. Do not cook eggs in the shelf, as they will explode. Occasionally a poached egg may burst during microwave cooking. Be sure to cook covered, and let stand one minute after cooking before removing the cover.
12. Do not cook any food surrounded by a membrane, such as egg yolks, potatoes, chicken livers, etc., without first piercing them several times with a fork.
13. Do not pop popcorn except in a microwave approved popcorn bag or in a commercial package recommended especially for microwave ovens. Never try to popcorn in a paper bag. If oil is used while making popcorn, overcooking may cause smoke and, eventually, fire.
14. Do not attempt to operate this appliance with the door open.
15. Do not attempt to remove covers, panels, etc.
16. Look at the oven from time to time when food is heated or cooked in disposable containers of plastic, paper or other combustible materials.
17. If smoke is observed, switch off or unplug the appliance and keep the door closed in order to stifle any flames.
18. Microwave heating of beverages can result in delayed eruptive boiling, therefore care has to be taken when handling the container.

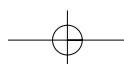

TO AVOID EXPLOSION AND SUDDEN BOILING

WARNING

When heating liquids, e.g. soups, sauces and beverages in your microwave oven, overheating the liquid beyond boiling point can occur without evidence of bubbling. This could result in a sudden boil over of the not liquid. To prevent this possibility the following steps should be taken:

- Avoid using straight sided containers with narrow necks.
- Do not overheat.
- Stir the liquid before placing the container in the oven and again halfway through the heating time.
- After heating, allow to stand in the oven for a short time, stir or shake them again carefully and check the temperature of them before consumption to avoid burns (especially, contents of feeding bottles and baby food jars).

1. Eggs

Never cook eggs in their shells. Steam will build up inside the shell during cooking and the egg will explode.

If you want to cook or reheat eggs which have not been broken up by scrambling or mixing, you must always pierce the yolks or these will also explode. You should slice shelled hard boiled eggs before you reheat them in your microwave oven.

2. Piercing

Always pierce food which has a skin or membrane, for example, potatoes, tomatoes, apples, sausages etc. If you don't pierce them, steam will build up inside and they may explode.

3. Lids

Always remove the lids of jars and containers and take away food containers, before you cook using your microwave oven. If you don't, then steam and pressure might build up inside and cause an explosion even after the microwave cooking has stopped.

WHICH UTENSIL CAN BE USED IN THE OVEN?

Before use, the user should check that utensils are suitable for use in microwave ovens.

Material	Grill & Convection cooking	Microwave cooking	Combined cooking
Glass (general)	No	Yes (1)	No
Glass (heat resistant)	Yes	Yes	Yes
Glass-ceramic and ceramic (heat resistant)	Yes	Yes (1)	Yes (1)
Earthenware	Yes	Yes	Yes
China (heat resistant)	Yes	Yes	Yes
Plastic (general)	No	Yes (2)	No
Plastic (heat resistant)	Yes (2)	Yes (2)	Yes (2)
Aluminium foil containers /aluminium foil	Yes	Yes (3)	Yes
Metal baking tins	Yes (4)	No	Yes (4)
Metal (pots.pans, etc)	Yes	No	No
Paper	No	Yes	No

- Without metal parts or metal trims.
- Some plastics are heat-proof only to certain temperatures. Check carefully!
- It is possible to use aluminium foil to shield delicate areas of food (this prevents over-cooking).
- Metal tins can be used in the combination methods, however if these are very deep, they will greatly reduce the efficiency, as metal shields the microwave energy from the food.

Microwave function only

Utensils and cooking containers used in a microwave oven should be of a material that does not act as a barrier to microwave energy. Generally this means that you should cook in either (paper), plastic, glass or ceramic. Metal pans reflect microwave energy and inhibit cooking, and should not be used. In addition to material, the shape of the container should also be considered. Round oval shapes give the most even cooking. Square or rectangular containers may over-cook foods in the corners because more energy is absorbed there. Shallow containers give more even cooking results.

Utensils made of china and ceramic excellent to use in your microwave oven. Most types of glass are also very good. Lead crystal glass can crack and should therefore, not be used. Plastics and paper can also be used, provided they can withstand the temperature of the heated food. For cooking only use plastics, which will withstand a temperature of over 120°C, e.g. polypropene and polyamide. Some plastic materials, e.g. melamine, will be heated by the microwave, and be damaged. To find out if a certain container is suitable, the following simple test can be made:

Place the empty container and a glass of water inside the microwave oven. The water is needed because the oven must not be operated empty or with empty containers only. Let the oven work on full power for one minute. A suitable container will only be lukewarm.

Metal containers, e.g. saucepans or frying pans should not be used in microwave ovens. Nor should plates or vessels with decorations be used since metal e.g. gold, might be part of the decoration and such decorations will be damaged.

Small pieces of aluminium foil can be used, but only to shield the areas that would over-cook (e.g. for covering chicken wings, leg tips and fish tails) but the foil must not touch the side of the oven as damage may occur.



Caution:

- There are a number of accessories available on the market. Before you buy, make sure they are suitable for microwave use.
- When you put food in the microwave oven, make sure that food, food supports or covering do not come in direct contact with any of the internal walls or the ceiling of the cavity since discolouration may take place.

CONTROL PANEL

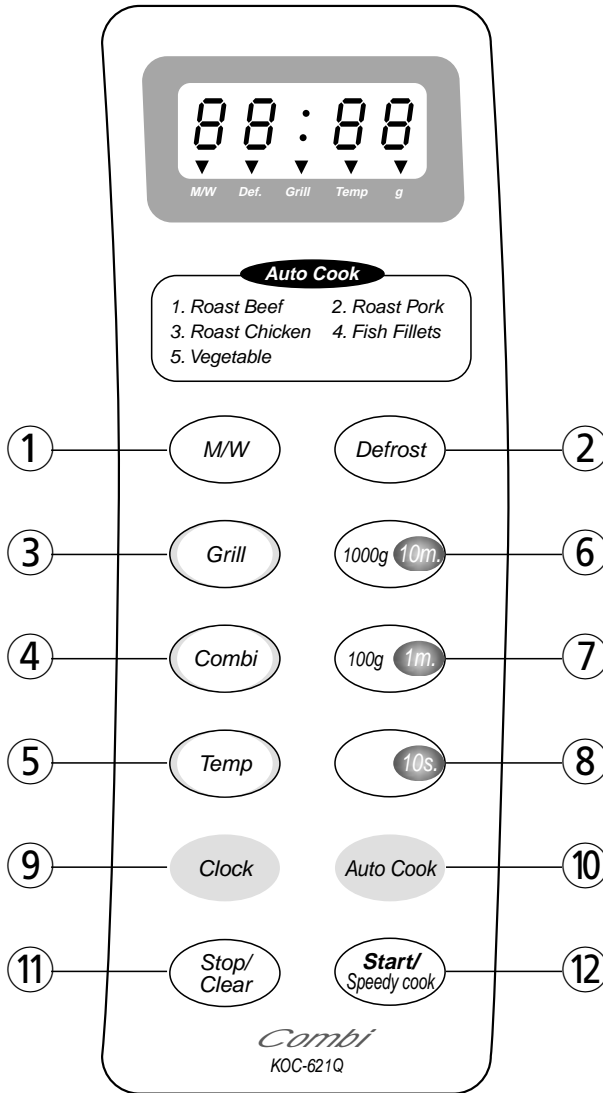

BUTTONS

- ① **M/W** : Press to select microwave power level.
- ② **Defrost** : Press to select weight/time defrost mode.
- ③ **Grill** : Press to select grill.
- ④ **Combi** : Press to select combi cooking mode.
- ⑤ **Temp** : Press to select temperature.
- ⑥⑦⑧ : Use to set time and weight.
- ⑨ **Clock**: Use to set clock.
- ⑩ **Auto cook** : Press to select auto cook menu.
- ⑪ **Stop/Clear** : Press once to stop a program, and twice to cancel a program.
- ⑫ **Start/Speedy cook** : Press to start a program, also for speedy start (each press adds 30 seconds microwave cooking time).

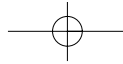

ACCESSORIES

This oven comes equipped with several accessories. They can be used in various ways to facilitate cooking.

■ Rotating base

This fits over the shaft in the center of the oven's cavity floor. This to remain in the oven for all cooking. It should only be removed for cleaning.

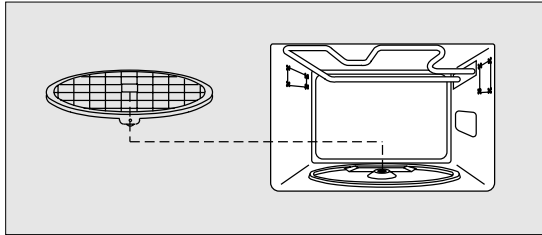

■ Turntable tray or turntable

This metal tray fits over the rotating base and locks into place. This is to be used in the oven for all cooking. It rotates clockwise or counterclockwise during cooking. It is easily removable for cooking and cleaning needs.

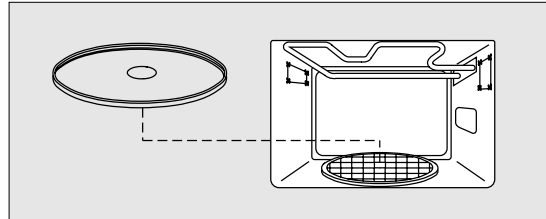

■ Metal rack

This metal rack is used with the turntable tray.

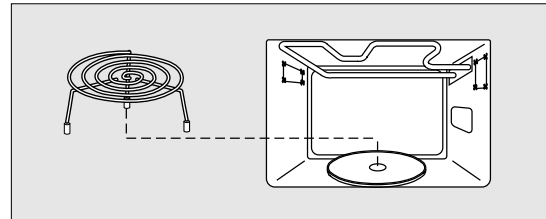

Important:

The rotating base must be placed in the center of the oven's cavity and fitted in the rotating shaft exactly. In case the rotating base does not fit in the rotating shaft, the rotating base might become as tray and sparks can occur.

■ HOW TO USE THE ACCESSORIES OF COOKING

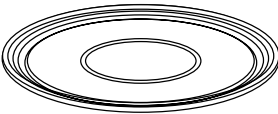
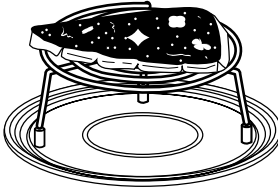
<p>■ Turntable</p>  <ul style="list-style-type: none"> • Microwave cooking • Oven cooking • Combination cooking • Auto cooking 	<p>■ Metal rack</p>  <ul style="list-style-type: none"> • Grill cooking
---	---

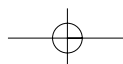

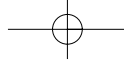

BEFORE OPERATION

SETTING THE CLOCK

When the oven is first plugged in, the display will flash " : 0" and a tone will sound.
If the AC power ever goes off, the display will flash " : 0" when the power comes back on.
Your oven has multiple (12H/24H) clock system. To set the clock follow under procedure.

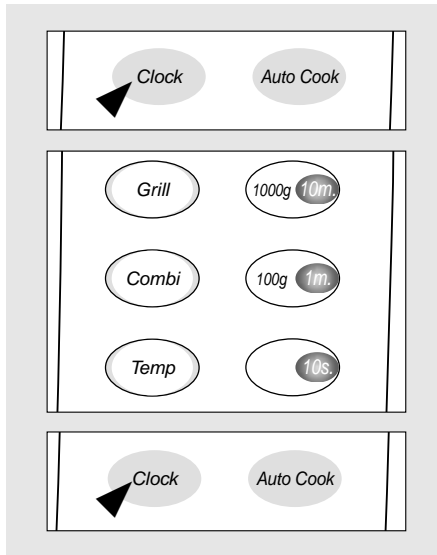

Example : To set 5:30

1. Touch **clock** button once. " **12H** " shows in display.
This is a 12 hour clock system.
2. Touch **clock** button once more. " **24H** " shows in display.
This is a 24 hour clock system.
If you want 12 hour clock system, omit this step.
3. Touch 10m. pad until **5:00** is indicated in the display window.
" **5:00** " shows in display.
4. Touch 1m. pad until **5:30** is indicated in the display window.
" **5:30** " shows in display.
5. Touch **clock** pad. The colon starts blinking.
If you selected 12 hour clock system, this digital clock allows you to set from 1:00 to 12:59.
If you selected 24 hour clock system, this digital clock allows you to set from 0:00 to 23:59.

CHILD LOCK AND POWER SAVE MODE

Child lock : The child lock prevents the oven from being used. For example because children could hurt themselves on hot liquids etc.
Power save mode : This function is used for saving energy.

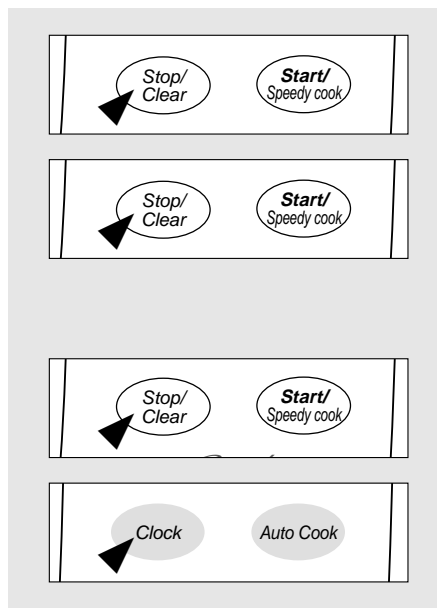

To set child lock

1. Touch **stop/clear** pad. " : 0" or clock appears in the display.
2. Press and hold **stop/clear** pad for 3 seconds.
The oven will beep and " : 0" shows in display previously.
Now the oven cannot be operated.
To operate the oven in child lock mode, press any key.
Then "Loc" will be shown.

To cancel child lock simply repeat setting procedure 2.
The oven will beep and " : 0" shows in display.
The oven is again available for normal use.

To set power save mode

1. Touch **stop/clear** pad. " : 0" or clock appears in the display.
2. Press and hold **clock** pad for 3 seconds. The oven will beep and nothing appears in the display. Now the oven is in power save mode.
To operate the oven in power save mode, press any key.
Then " :0" or clock will be shown and the operation of all function key will be same as in normal mode. But if there is no operation within 10 seconds in clear mode or while manipulating the key, all the contents of display will disappear.
When fan operates still, the display will turn off after finishing fan operating.

To cancel power save simply repeat setting procedure.
"12H(24H)" appears in the display. After 3 seconds the oven will beep, this indicates that the power save is cancelled and the oven is again available for normal use.

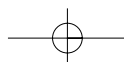

OPERATION

Note : Using your oven

- Hot Surfaces**
Exterior oven surfaces, including air vents on the cabinet and the oven door, will get hot during Grill, Combination and Oven cooking. Carefully use when opening or closing door and when inserting or removing food and accessories. After using the above cooking functions, the roof and walls will be very hot.
- Children should be kept away from the oven at all times and should only be allowed to operate the oven under supervision. Ensure that children do not touch the hot outer casing after operation of the oven.
- Before Use**
Before using for the first time, operate the oven without food and accessories (including turntable tray and rotating base) on Grill for 10 minutes. This will allow the oil that is used for rust protection to be burned off. This is the only time that the oven is operated empty. (without this burning, when first time of use, there may be some bad odours or smoke)
- Fan cooling and drying**
After finishing the exceed 5 minutes cooking, the fan will operate about 5 minutes in order to cool and dry itself.

MICROWAVE COOKING

This microwave cooking method allows you to cook food for a desired time. In addition to the maximum power level, you can select different microwave power from 9 other levels, 10% to 90% for the foods that require slower cooking.

If you have used the appliance for grilling, convection or combination cooking, let the oven cool down before using again. Never switch the microwave oven on when it is empty.

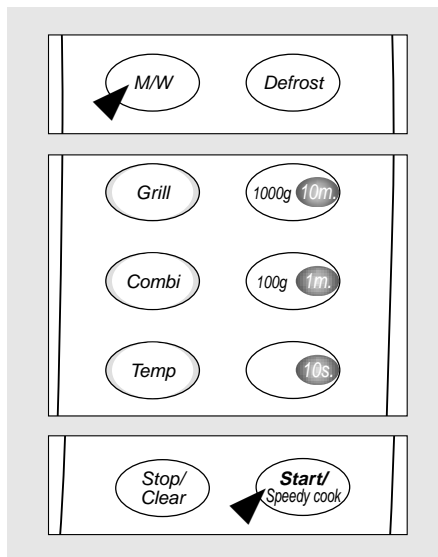

- Touch **m/w** pad once. **m/w** indicator lights. "P-Hi" shows in display.
- Select the appropriate power level by pressing the **m/w** pad again until the corresponding percentage is displayed. Refer to the power level table below for further details.
- Touch 10m., 1m., 10s. to set the cooking time.
For a cooking time of 5 minutes 30 seconds, touch 1m., 10s. pad until "5:30" is indicated in the display window.(up to 60 minutes) "5:30" shows in display.
- Touch **start/speedy cook** pad.
The **m/w** indicator starts blinking.
The oven light comes on and the turntable starts rotating.
Cooking starts and the time in the display will count down.

Note : The oven will automatically work on 100% microwave power if a cooking time is entered without the power level previously being selected.

Power level table

Power level	percentage	Output	Power level	percentage	Output
High	100% (P-Hi)	800W	Medium	50% (P-50)	390W
Sauté	90% (P-90)	720W	Medium low	40% (P-40)	300W
Reheat	80% (P-80)	630W	Low	30% (P-30)	220W
Medium high	70% (P-70)	550W	Defrost	20% (P-20)	140W
Simmer	60% (P-60)	470W	Warm	10% (P-10)	90W

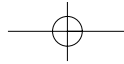

GRILL COOKING

The grill enables you to heat and brown food quickly, without using microwaves.
The oven has an upper and lower grill which can be operated independently or combined.

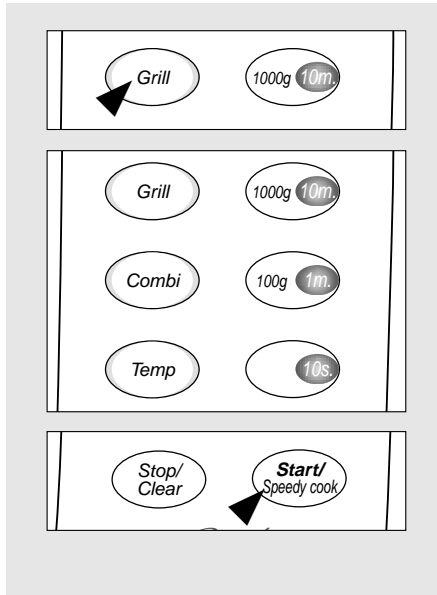

1. Touch **grill** button once. **Grill** indicator lights.
": 0" shows in display.
2. Touch 10m., 1m., 10s. pad to set the grilling time.
For a grilling time of 11 minutes 00 seconds, touch 10m., 1m. pad once. (up to 30 minutes) "11:00" shows in display.
3. Touch **start/speedy cook** pad.
The **grill** indicator starts blinking.
The oven light comes on and the turntable starts rotating.
Cooking starts and the time in the display will count down.

Note : When first using the grill heaters, smoke and odour will be given off. To avoid this happening when food is being cooked, heat the upper and lower grills without food for approximately 10 minutes.

WARNING :
The temperature inside the oven and window is very high.
Do not touch the oven window and metallic interior of the oven when taking food in and out.
Use thick oven gloves while handling food or accessories.

OVEN COOKING(traditional cooking)

The oven mode enables you to cook food in the same way as in a traditional oven. Microwaves are not used.
Always use oven gloves when touching the recipients in the oven, as they will be very hot.

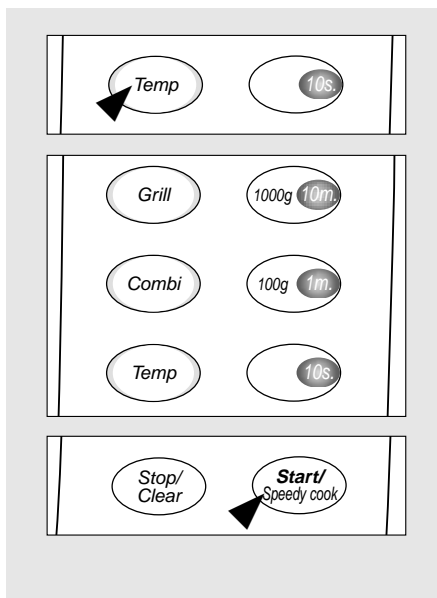

1. Touch **temp** pad once. The **Temp** indicator starts blinking.
"100C" shows in display.
2. Select the oven cooking temperature by pressing the **temp** pad again until the corresponding temperature is displayed.

Sequence

100C → 110C → 120C → 130C → 140C → 150C →
160C → 170C → 180C → 190C → 200C → 210C →
40C → 100C →

3. Touch 10m., 1m., 10s. pad to set the cooking time.
For a cooking time of 11 minutes, touch 10m., 1m. pad once. (up to 99 minutes) "11:00" shows in display.
4. Touch **start/speedy cook** pad.
The oven light comes on and the turntable starts rotating.
Cooking starts and the time in the display will count down.

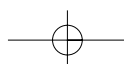

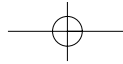

OVEN COOKING(with pre-heat)

For oven cooking, it is recommended that you preheat the oven to the appropriate temperature before placing the food in the oven. (except for 40°C)

The maximum preheating time is 30 minutes. If the cooking is not started immediately after preheating, the preheated oven temperature will continue to blink. It is maintained for 15 minutes; it is then switched off automatically.

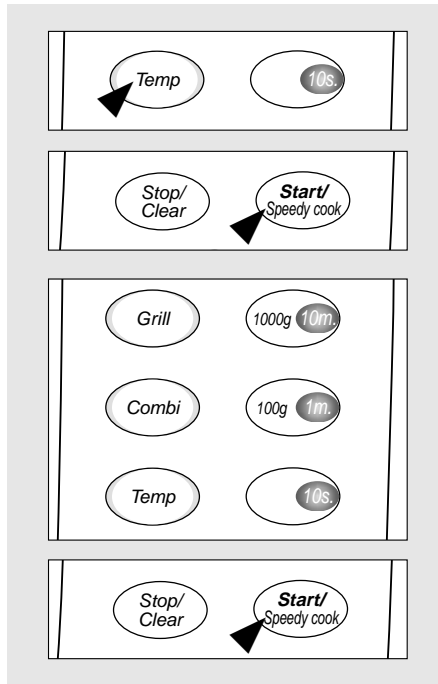

1. Touch **temp** pad once.
"100C" shows in display.
2. Select the convection cooking temperature by pressing the **temp** pad again until the corresponding temperature is displayed.

Sequence

100C → 110C → 120C → 130C → 140C → 150C →
160C → 170C → 180C → 190C → 200C → 210C →
40C → 100C →

3. Touch **start/speedy cook** pad. The **temp** indicator starts blinking.
The oven will now preheat. When oven is preheated the oven will beep and the oven temperature starts blinking.
Then open the door and place your food in the oven.
Oven temperature shows in display.
4. Touch 10m., 1m., 10s. pad to set the cooking time.
For a cooking time of 11 minutes, touch 10m., 1m. pad once. (up to 99 minutes) "11:00" shows in display.
5. Touch **start/speedy cook** pad.
The oven light comes on and the turntable starts rotating.
Cooking starts and the time in the display will count down.

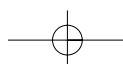

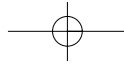

COMBINATION COOKING

This function allows you to combine the speed of a microwave with the browning and crustying of a grill. Always use microwave-safe and oven-proof cookware.

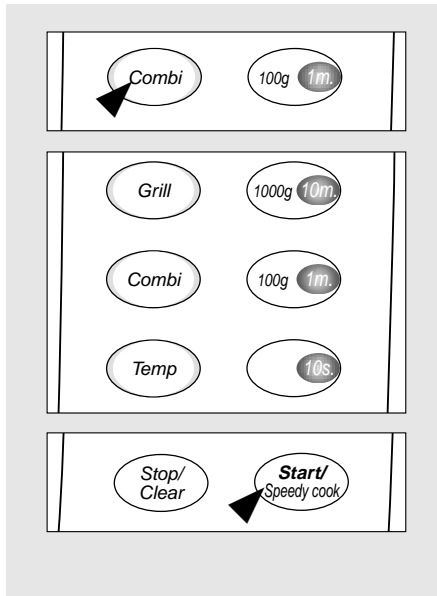

1. Touch **combi** pad once.
m/w and **grill** indicator light.
"C-HI" shows in display.
2. Touch 10m., 1m., 10s. pad to set the cooking time.
For a cooking time of 11 minutes, touch 10m., 1m. pad once. (up to 60 minutes) "11:00" shows in display.
3. Touch **start/speedy cook** button.
The **m/w** and **grill** indicator start blinking.
The oven light comes on and the turntable starts rotating.
Cooking starts and the time in the display will count down.

Touch combi pad	Display	m/w power level
Once	C-HI	40%
Twice	C-O	30%
3 times	C-Lo	20%

DEFROST

Your oven multiple(weight/time) defrost system.
Use only recipients that are microwave-safe.

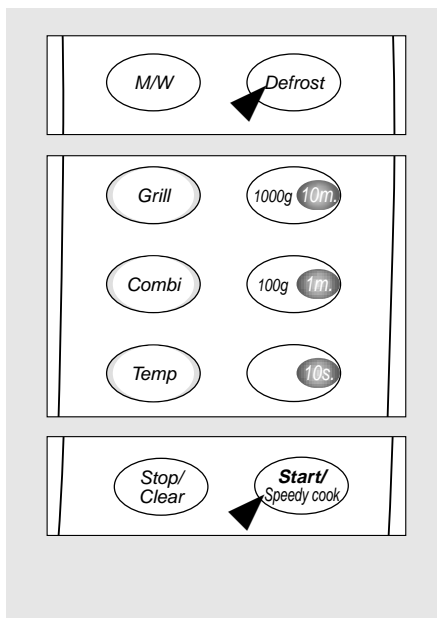

WEIGHT DEFROST

1. Touch **defrost** pad once. **Def.** and **g** indicator light.
"0" shows in display.
2. Touch 10m.(1000g), 1m.(100g), pad to set the defrosting weight.
For a defrosting weight of 1000 grams, touch 10m(1000g) pad once.
(min.200g-max.3000g) "1000" shows in display.
3. Touch **start/speedy cook** pad.
The **Def.** indicator start blinking.
The oven light comes on and the turntable starts rotating.
Cooking starts and the time in the display will count down.

TIME DEFROST

1. Touch **defrost** button twice. **Def.** indicator light.
":0" shows in display.
2. Touch 10m., 1m., 10s. pad to set the defrosting time.
For a cooking time of 11 minutes, touch 10m., 1m. pad once. (up to 60 minutes) "11:00" shows in display.
3. Touch **start/speedy cook** pad.
The **Def.** indicator start blinking.
The oven light comes on and the turntable starts rotating.
Cooking starts and the time in the display will count down.

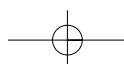

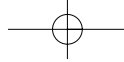

AUTO COOK

This function allows you to simply and automatically cook a range of popular foods. Always use oven gloves when touching the recipients in the oven.

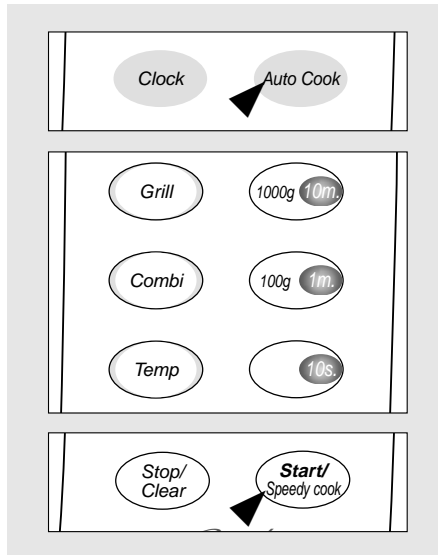

1. Touch **auto cook** pad once. **m/w**, and **grill** indicator light. **g** indicator starts blinking. "AC-1" shows in display.
2. Select the menu by pressing the Auto cook button until the required menu is displayed. Refer to the auto cook menu chart below for further details.
3. Touch 10m.(1000g), 1m.(100g) pad to set the cooking weight. For a cooking weight of 1000 grams, touch 10m(1000g) pad once. (up to 2000 grams) "1000" shows in display. Refer to the auto cook menu chart below for further details.
4. Touch **start/speedy cook** button. **m/w** and **grill** indicator start blinking. The oven light comes on and the turntable starts rotating. Cooking starts and the time in the display will count down.

Auto Cook Menu Chart

Display	Press auto cook key	Auto Cook Menu	Minimum Weight	Maximum Weight
AC-1	Once	1 ROAST BEEF	500 g	2000 g
AC-2	Twice	2 ROAST PORK	500 g	2000 g
AC-3	3 times	3 ROAST CHICKEN	800 g	2000 g
AC-4	4 times	4 FISH FILLETS	200 g	700 g
AC-5	5 times	5 VEGETABLES	200 g	700 g

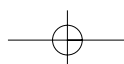

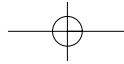

SPEEDY COOK

The speedy cook function allows the oven to begin cooking immediately on full power **800W**. The speedy cook button has been pre-programmed to increase in increments of 30 seconds up to a maximum time of 5 minutes.

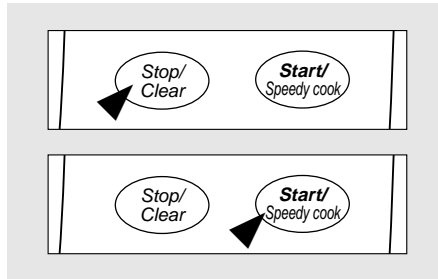

1. Touch **stop/clear** button.
": 0" or clock appears in the display.
2. Touch **start/speedy cook** button once.
m/w indicator lights up and the oven begins to operate immediately.
The oven light comes on and the turntable starts rotating.

TO STOP THE OVEN WHILE THE OVEN IS OPERATING

1. Open the door.
 - Oven stops operating.
 - You can restart the oven by closing the door and touching **start/speedy cook** button.
2. Press the **stop/clear** button.
 - Oven stops operating.
 - If you wish to cancel the cooking settings, press the **stop/clear** button again.

ABNORMAL MESSAGE

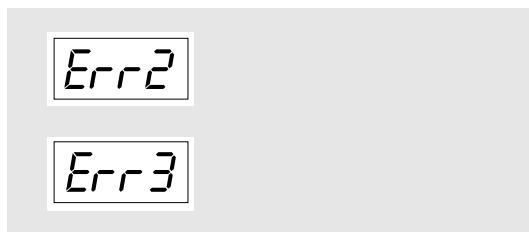

- If the inside temperature of the oven is higher than expected or the temperature sensor doesn't work properly, "Err2" message will be shown in the display.
- Unplug the power and call our technical service.
- When the temperature sensor is disconnected, "Err3" message will be shown in the display.
- Unplug the power and call our technical service.

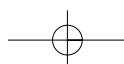

GENERAL GUIDE LINES

Since microwave cooking to some extent is different from traditional cooking, the following general guidelines should be considered whenever you use your microwave oven

If the food is undercooked

Check if:

- You have selected the correct power level.
- The selected time is sufficient-the times given in the recipes are approximate. They depend on initial temperature, weight and density of the food etc.
- The container is appropriate.

If the food is overcooked,i.e. dried out or burnt

Before you cook again, consider whether:

- The power level was too high.
- The set time was too long-the times in the recipes are approximate. They depend on initial temperature, weight and density of the food etc.

Points to remember when defrosting

- The shape of the package alters the defrosting time. Shallow rectangular packets defrost more quickly than a deep block. Separate pieces as they begin to defrost; free how slices defrost more easily.
- Shield areas of food with small pieces of foil if they start to become warm.
- When defrosting, it is better to under thaw the food slightly and allow the process to finish during the standing time.

The amount of food

The more food you want to prepare the longer it takes. A rule of thumb is that double amount of food requires almost double the time. If one potato takes four minutes to cook, approximately seven minutes are required to cook two potatoes.

Starting temperature of food

The lower the temperature of the food which is being put into the microwave oven, the longer time it takes. Food at room temperature will be reheated more quickly than food at refrigerator temperature.

Composition of the food

Food with a lot of fat and sugar will be heated faster than food containing a lot of water. fat and sugar will also reach a higher temperature than water in the cooking process. The more dense the food, the longer it takes to heat. "Very dense" food like meat takes longer time to reheat than lighter, more porous food like sponge cakes.

Size and shape

Smaller pieces of food will cook more quickly than larger pieces and uniform pieces of food cook more evenly than irregularly shaped foods.

With unevenly shaped food, the thinner parts will cook faster than the thicker areas. Place the thinner chicken wings and legs to the centre of the dish.

Stirring, turning of foods

Stirring and turning of foods are techniques used in conventional and well as in microwave cooking to distribute the heat quickly to the centre of the dish and avoid over-cooking at the outer edges of the food.

Covering food helps:

- To reduce spattering
- To shorten cooking times
- To retain food moisture

All covering, which will allow microwaves to pass through are suitable-See above "Which utensils can be used in the oven?"

Releasing pressure in foods

Several foods are tightly covered by a skin or membrane. These foods should be pricked with a fork or cocktail stick to release the pressure and to prevent bursting, as steam builds up within them during cooking. This applies to potatoes, chicken livers, sausages, egg yolks and some fruits.

Standing time

Always allow the food to stand for some time after using the oven. standing time after defrosting, cooking/reheating always improves the result since the temperature will then be evenly distributed through out the food.

In a microwave oven foods continue to cook even when the microwave energy is turned off. They are no longer cooking by microwaves, but they are still being cooked by the conduction of the high residual heat to the centre of the food. The length of standing time depends on the volume and density of the food. Sometimes it can be as short as the time it takes you to remove the food from the oven and take it to the serving table. However, with larger, denser foods, the standing time may be as long as 10 minutes. During 'standing', the internal temperature of the food will rise by as much as 8°C and the food will finish cooking in this time.

Arranging food

This is done in several ways in microwave cooking to give more even cooking results.

If you are cooking several items of the same food such as jacket potatoes, place them in a ring pattern for uniform cooking. When cooking foods of uneven shapes or thickness, place the smaller or thinner area of the food towards the centre of the dish where it will be heated last.



Uneven foods such as fish should be arranged in the oven with the tails to the centre.

If you are saving a meal in the refrigerator or 'plating' a meal for reheating, arrange the thicker, denser foods to the outside of the plate and the thinner or less dense foods in the middle.

Place thin slices of meat on top of each other or interlace them. Thicker slices such as meat loaf and sausages have to be placed close to each other. Gravy or sauce should be reheated in a separate container.



Choose a tall, narrow container rather than a low and wide container. When reheating gravy, sauce or soup, do not fill the container more than 2/3.



When you cook or reheat whole fish, score the skin this prevents cracking. Shield the tail and head with small pieces of foil to prevent over-cooking but ensure the foil does not touch the sides of the oven.



KEEP THE OVEN CLEAN

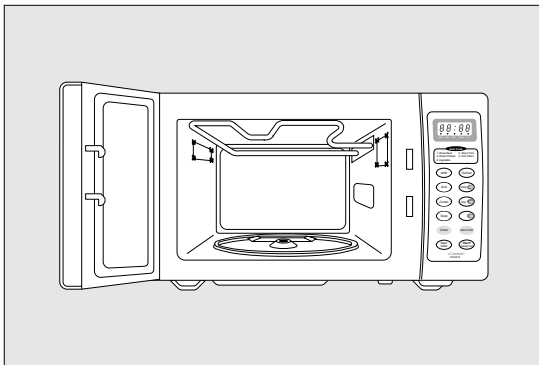

INSIDE THE OVEN

The interior three side walls and floor are stainless steel. For easy cleaning, wipe spills and splatters as they occur with a damp cloth or sponge with water and a mild detergent. Rinse the cavity of any cleaning residue with a clean damp or sponge after cleaning. Dry with a soft cloth.

These areas can also be cleaned by using plastic or nylon scouring pads recommended for use of Teflon and Silverstone*.

For hard to remove soil, use a mild non-abrasive cleaner. Use on the stainless steel areas, turntable and rotating base only.

FLOOR

A grill element is installed under the floor, and there are holes on the floor over the grill. Therefore, you must be very careful not to drop any waterdrops or spills over the holes. Do not wipe the holed-surface with a damp cloth or detergent. Only use soft, clean and dry cloth.

When you clean the groove or floor with a damp cloth, you need to be careful not to touch the holed-surface.

TOP SURFACE

Two quartz grill elements are installed on the top surface. As they are fragile, be careful not to press or grip them hard. Do not remove the grill elements to clean the surface.

Warning

Just as your traditional oven becomes hot also this oven will become hot during use of the grill functions or in combination with microwaves. Children should be supervised at all times when using the oven.

TURNTABLE AND ROTATING BASE

These two parts are easily removable for cleaning. The turntable should be cleaned frequently and is dishwasher proof. If food spills are accumulated under the rotating base, the oven will not operate efficiently. Be sure to wipe up any spills as they occur in this area.

Clean these parts as described in by the same method of cleaning inside the oven. Be sure to properly reinstall these parts into the cavity after cleaning.

Note:

Do not use any other Turntable in the oven. Do not operate the oven without the Turntable and Rotating Base Properly in place.

DOOR

While the oven door is still warm, any splatters or food soils should be wiped off with a damp sudsy cloth or sponge. Rinse with water and wipe dry with a cloth.

If steam or condensation appears around this area, wipe with a cloth. This may occur when the oven is operating under high humidity and with foods containing lots of moisture. This is a normal part of microwave cooking.

Note:

• Although your oven is provided with safety features, it is important to observe the following:

1. It is important not to defeat or tamper with safety interlocks.
2. Do not place any object between the oven front face and the door or allow residue to accumulate on sealing surfaces. Wipe the sealing area frequently with a mild detergent, rinse and dry. Never use abrasive powers or pads.
3. When opened, the door must not be subjected to strain, for example, a child hanging on an open door or any load could cause the oven to fall forward to cause injury and also damage to the door. Do not operate the oven if it is damaged, until it has been repaired by a service technician. It is particularly important that the oven closes properly and that there is no damage to the:
 - 1) Door(bent)
 - 2) Hinge and Hookes(broken or loosened)
 - 3) Door seals and sealing surface.
4. The oven should not be adjusted or repaired by anyone except a properly trained service technician.

EXTERIOR

CONTROL PANEL

Exercise care when cleaning this area. To clean, wipe the panel with a slightly dampened cloth, using only water. Wipe dry. Do not scrub this area or use any sort of chemical cleaner. Avoid use of excess water.

OUTSIDE SURFACE

The outside surfaces should be cleaned with soap and water, rinsed and dried with a soft cloth. Do not use any type of household or abrasive cleanser.

Note:

- DO NOT USE ANY TYPE OF OVEN CLEANER ON ANY PART OF THE OVEN. It will damage some of the interior and exterior surfaces of the oven.
- In order to keep the good condition of your oven, clean the inside after each cooking.

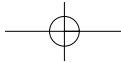

BEFORE CALLING FOR SERVICE

You can often correct operating problems yourself. If your microwave/grill oven fails to work properly, locate the operating problem in the chart below and try the solutions marked for each problems.

If the microwave/grill oven still does not work properly, contact the nearest Service Centre.

Note:

It is quite normal for steam to be emitted around the door during the cooking cycle. The door is not intended to seal the oven cavity completely but its special design contributes to the complete safety of the appliance.

Caution:

1. Do not attempt to operate the oven while empty as this will cause damage.
2. As an exhaust is located in the rear of the oven, install the oven so as not to block the outlet.
If the microwave/grill oven still does not work properly, contact the nearest Service Centre.

PROBLEM		1	2	3	4	5	6	7	8	9	10	11	12
Oven will not start		X	X	X	X								
Arcing or sparking						X	X						
Unevenly cooked foods					X		X	X	X				
Overcooked foods										X			
Undercooked foods					X				X	X	X		
Improper defrosting					X		X	X		X			X

SOLUTION		1	2	3	4	5	6	7	8	9	10	11	12
Is start button pressed?		✓	✓	✓	✓								
Is power cord plugged in?													
Is door closed?													
Set the cooking time.													
Use approved cookware only.													
Do not operate with oven empty.													
Supplied tray must be used.													
Turn of stir food.													
Completely defrost food.													
Push correct numeral pads / Press correct Function buttons													
Check to see that oven ventilation parts are not blocked.													
Open the door slightly and wait 10-15 minutes, for cooling.													

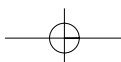

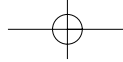

QUESTIONS AND ANSWERS

Q: I accidentally ran my microwave oven without any food in it. is it damaged?

A: We do not recommend to operating the microwave oven without any food. However, running the oven empty for a SHORT time will not damage the oven.

Q: Can I open the door when the oven is operating?

A: The door can be opened anytime during the oven operation. Microwave energy will be instantly switched off and the time setting will maintain until the door is closed.

Q: Does microwave energy pass through the viewing screen in the door?

A: No. The metal screen bounces back the energy to the oven cavity. The holes are made to allow light to pass through. They do not let microwave energy pass through.

Q: My microwave oven causes interference with my TV. is this normal?

A: Some radio and TV interference might occur when you cook with the microwave oven. This interference is similar to the interference caused by small appliances such as mixers, vacuums, blow dryers, etc. It does not indicate a problem with your oven.

Q: How can we know whether the oven is operating or not?

A: Oven is operating only when the door is closed. After the end of oven cooking, the cooling fan will run for two minutes.

Q: Why does my oven light dim?

A: When cooking at reduced power level, the oven must cycle to obtain the selected power levels. The oven light, dims and clicking noises can be heard when the oven cycles.

Q: When is the oven light on and off?

A: The oven light is on during the cooking time and when the door is opened.

Q: Why does steam accumulate on the oven door?

A: During cooking, steam is given off from the food. Most of the steam is removed from the oven by the air which circulates in the oven cavity. However, some steam will condense on cooler surfaces such as the oven door. This is normal.

Q: Sometimes warm air comes from the oven vents. Why?

A: The heat given off from the cooking food warms the air in the oven cavity. This warmed air is carried out of the oven by the air flow pattern in the oven. There are no microwave in the air. The oven vents should never be blocked during cooking.

Q: Why does the smoke come out of the exhaust vent at the back of oven?

A: It is normal for smoke to come out of the vents during cooking. Smoke may be produced when food is overcooked.

SPECIFICATIONS

Power supply		230V~, 50Hz
Microwave	Power consumption	1250W
	Output power	800W (IEC 705)
	Frequency	2,450MHz
Grill power consumption		1250W
Convection power consumption		1650W
Combination heating power consumption		2500W
Outside Dimension(WXDXH)		470(18.5)X376(14.8)X285(11.2)mm (inch)
Cavity Dimensions(WXDXH)		295(11.6)X300(11.8)X167(6.6)mm (inch)
Net Weight		Approx. 14.5Kg (32 lbs.)
Timer		Oven: 99 minutes, M/W: 60 minutes, Grill: 30 minutes
Select function		Microwave / Grill / Oven / Combination
Microwave power level		10 levels

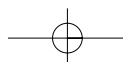

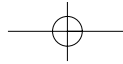

DAEWOO ELECTRONICS SALES UK LIMITED

YOUR PRODUCT GUARANTEE

Dear Customer,

Thank you for buying this Daewoo product. In the unlikely event of a failure all repair work will be carried out by your retailer or Daewoo approved service centre, for a period of 12 months from date of sale.

Daewoo Electronics Sales UK Ltd., will provide the following services in order to expedite this guarantee.

During this period should a fault occur due to improper materials or workmanship, the retailer, authorised service centre, or authorised service dealer will carry out repairs at no cost to yourself. Replacement products will be offered at the discretion of your supplying dealer.

This guarantee will be honoured by Daewoo service networks in other E.C. members states, in accordance with the terms and conditions which prevail in the member state at the time service is requested.

CONDITIONS

Any claims made under the terms of the guarantee must be supported by the original invoice/bill of sale issued at the time of sale. Daewoo reserve the right to refuse guarantee should any of the information on the bill of sale be removed or changed in any way after the original purchase of the product by the consumer from the retailer.

Modifications or adjustments made to the product which enable it to conform to local technical or safety standards in force in any country other than the one for which the product was originally designed and manufactured, are not included in this guarantee. Failures arising from such modifications, whether performed properly or not, will not be covered by this guarantee.

THIS GUARANTEE DOES NOT COVER ANY OF THE FOLLOWING:-

- 1) Periodic maintenance, the repair or replacement of parts due to normal wear and tear.
- 2) Home service transport cost, and other costs and risks of transport relating directly or indirectly to the guarantee of the product.
- 3) Damage to this product resulting from: the above and misuse, including but not limited to the failure to use this product for its normal purpose or in accordance with the instructions on the proper use and maintenance of this product, and the installation or the use of this product in a manner inconsistent with the technical or safety standards in force in the country where the product is used.
- 4) Repairs carried out by non-authorised service centres.
- 5) Accidents, acts of God, or any cause beyond the control of Daewoo including but not limited to lightning, water, fire and improper ventilation.
- 6) Aerial alignment and consumer control adjustments
- 7) Batteries whether supplied by Daewoo or not which become worn or exhausted in use.
- 8) Loss or damage caused to any item or article used with this product. This includes (but not limited to) discs, tapes, records, and films.

This guarantee does not affect your statutory rights as a consumer, nor your rights against the retailer, arising from their sales or purchase contract.

In the absence of applicable legislation, this guarantee will be the consumers sole and exclusive remedy, and neither Daewoo nor its subsidiary, or distributor shall be liable for any incidental or consequential damages for breach of any express or implied guarantee of this product.

For further information regarding this or any other query you may have about Daewoo products or its services please write to:-

Daewoo Electronics Sales UK Limited
Daewoo Building
Wharfdale Road
Winnersh Triangle
Workingham
Berkshire RG11 5TP

**IN ALL CASES OF DIFFICULTY-CONSULT YOUR DAEWOO
DEALER FROM WHOM THE PRODUCT WAS PURCHASED**

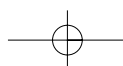

Free Manuals Download Website

<http://myh66.com>

<http://usermanuals.us>

<http://www.somanuals.com>

<http://www.4manuals.cc>

<http://www.manual-lib.com>

<http://www.404manual.com>

<http://www.luxmanual.com>

<http://aubethermostatmanual.com>

Golf course search by state

<http://golfingnear.com>

Email search by domain

<http://emailbydomain.com>

Auto manuals search

<http://auto.somanuals.com>

TV manuals search

<http://tv.somanuals.com>