

DAEWOO

MICROWAVE CONVECTION/GRILL OVEN

KOC985T

OPERATING
INSTRUCTIONS

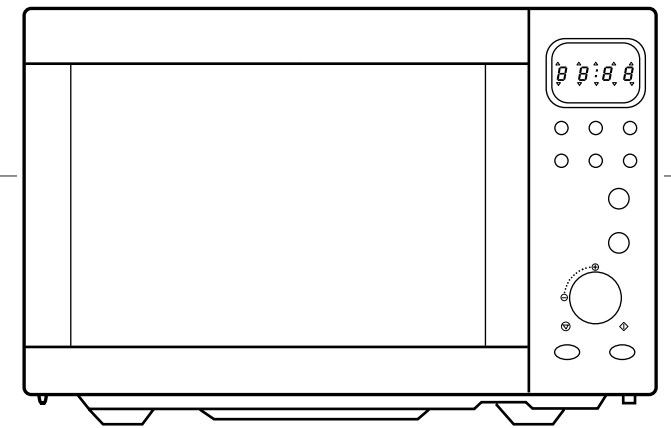

Before operating this oven, please read these instructions completely.

PRECAUTIONS TO AVOID POSSIBLE EXPOSURE TO EXCESSIVE MICROWAVE ENERGY

- (1) Do not attempt to operate this oven with the door open** since open-door operation can result in harmful exposure to microwave energy. It is important not to override or tamper with the safety interlocks.
- (2) Do not place any object** between the oven front face and the door, or allow food particles or cleaner residue to accumulate on sealing surfaces.
- (3) Must not be operated the oven** if it is damaged. It is particularly important that the oven door close properly and that there is no damage to the:
(1) Door (bent), (2) hinges and latches (broken or loosened), (3) door seals and sealing surfaces.
- (4) The oven should not be adjusted or repaired** by anyone except properly qualified service personnel.
It is hazardous for anyone other than a trained person to carry out any service or repair operation which involves the removal of any cover which gives protection against exposure to microwave energy.

CONTENTS

INSTALLATION AND EARTHING INSTRUCTIONS	2
IMPORTANT SAFETY INSTRUCTIONS	3
WHICH UTENSILS CAN BE USED IN THE OVEN?	4
CONTROL PANEL	5
ACCESSORIES	6
HOW TO SET THE OVEN CONTROLS	7
GENERAL GUIDELINES	12
KEEP THE OVEN CLEAN	13
BEFORE CALLING FOR SERVICE	14
QUESTIONS AND ANSWERS	15
SPECIFICATIONS	15

INSTALLATION AND EARTHING INSTRUCTIONS

How to examine your microwave oven after unpacking.

Unpack oven, remove all packing material, and examine the oven for any damage such as dents, broken door, latches or cracks in the door. Do not remove the film from inside the door. Notify dealer immediately if the oven is damaged. Do not install if the oven is damaged.

Where to place your microwave oven.

- Place the oven on a flat and stable surface.
- Surface of the oven is protected by a plastic film which should be removed before using.
- Leave space behind and sides and upper of the oven. All air vents should be kept a clearance.
If all vents are covered during operation, the oven may overheat and, eventually, lead to oven failure.
- Keep away from radio and TV sets. If the oven is located close to a TV, radio interference may result.
- Keep away from heating appliances and water taps. Keep the oven away from hot air, steam or splash when choosing a place to position it, or the insulation might be adversely affected and breakdowns occur.
- The minimum height of free space necessary above the top surface of the oven is minimum 150mm.

Prior to use (If your oven has a grill element)

In order to protect your oven during transportation and storage, the grill element is covered with a protective coating. To remove this coating the grill element must be heated for 5 minutes. This procedure will produce some bad odours as the protective coating on the element disappears.

To remove the coating, use the following procedures:

- Place an overproof and microwave safe bowl, containing 200cc of water or more, in the oven.
- Press the °C Temp button.
- Set the time to 5 minutes.
- Press the start button.
- When the 5 minutes has elapsed, an acoustic signal sounds.

Note:

The protective coating has now been removed and the oven is ready to use. Please be aware that your oven now is very hot.

- Open the oven door and remove the bowl with water (use oven gloves when removing the bowl).

CHILD LOCK

To prevent child from operating the oven, install the childlock key.

- Touch stop button for 3 seconds.
"LOC" will show in the display and all buttons do not operate.
- Touch stop button for 3 seconds once again, then childlock is canceled.

- WARNING: Only allow children to use the oven without supervision when adequate instructions have been given so that the child is able to use the oven in a safe way and understands the hazards of improper use.

Electrical Connection

WARNING-THIS APPLIANCE MUST BE EARTHED.

REFER TO RATING PLATE FOR VOLTAGE AND CHECK THAT THE APPLIANCE VOLTAGE CORRESPONDS WITH THE SUPPLY VOLTAGE IN YOUR HOME.

The flexible mains lead must be correctly connected, as below, to a three pin plug of not less than 13 AMP capacity. You must use a 3 pin plug which should be marked with the number BS 1363 and it should be fitted with 13 AMP fuse marked with the number BS 1362.

We recommend the use of good quality plugs and wall sockets that can be switched off when the machine is not in use.

IMPORTANT-The wires in the mains lead fitted to this appliance are coloured in accordance with the following code

GREEN AND YELLOW-EARTH
BLUE-NEUTRAL
BROWN-LIVE

As the colour of the wires in the mains lead of this appliance may not correspond with the coloured markings identifying the terminals in your plug, proceed as follows:

Power supply

Check your local power source. This oven requires a current of approximately 12(8)amperes, 230V 50Hz.

Power supply cord is about 1.2 meters long.

The voltage used must be the same as specified on this oven.

Using a higher voltage may result in a fire or other accident causing oven damage. Using low voltage will cause slow cooking. We are not responsible for damage resulting from use of this oven with a voltage of ampere fuse other than those specified.

If the supply cord is damaged, it must be replaced by the manufacturer or its service agent or a similarly qualified person in order to avoid a hazard.

The wire which is coloured GREEN AND YELLOW must be connected to the terminal in the plug which is marked with the letter "E" or the earth symbol \perp or coloured GREEN AND YELLOW, or GREEN.

The wire which is coloured BLUE must be connected to the terminal which is marked with the letter "N" or coloured BLACK, or BLUE.

The wire which is coloured BROWN must be connected to the terminal which is marked with the letter "L" or coloured RED, or BROWN.

If the terminals in the plug are unmarked or you are in any doubt as to the correct connections, consult a qualified electrician.

If you do not make the proper electrical connections you will damage your microwave oven and possibly injure yourself. Neither the manufacturer nor the supplier are liable if this happens.

MOULDED PLUGS

Should it be necessary to remove a moulded on plug from the mains cable, it should be cut off and replaced with a suitable replacement.

The moulded plug cannot be used for any other appliance, therefore remove the fuse and dispose immediately and safely to prevent anyone, especially children from plugging it in to a wall socket, which will create a safety hazard.

Should the mains lead ever require replacement, it is essential that this operation be carried out by a qualified electrician and should only be replaced with a flexible cord obtained from the manufacturer.

Applicable only if moulded plug is fitted.

After replacement of a fuse in the plug, the fuse cover must be refitted. If the fuse cover is lost, a replacement cover is obtained. The colour of the correct replacement fuse cover is that of the coloured insert in the base of the plug or the colour that is embossed in words in the base of the plug recess or elsewhere on the plug. Always state this colour when ordering a replacement fuse cover.

Only 13 amp replacement fuses which are ASTA approved to BS 1362 should be fitted

IMPORTANT SAFETY INSTRUCTIONS

When using electrical appliances, basic safety precautions should be followed, including the following:

WARNING-To reduce the risk of burns, electric shock, fire, injury to persons or exposure to excessive microwave energy:

1. Read all instructions before using the appliance.
2. Read and follow the specific "PRECAUTIONS TO AVOID POSSIBLE EXPOSURE TO EXCESSIVE MICROWAVE ENERGY", found on page 1.
3. This appliance must be earthed. Connect only to a properly installed wall socket.
4. Install or locate this appliance only in accordance with the provided installation instructions.
5. Some products such as whole eggs and sealed containers for example, closed glass jars-may explode and should not be heated in this oven.
6. Use this appliance only for its intended use as described in this manual.
7. As with any appliance, close supervision is necessary when used by children.
8. Do not operate this appliance if it has a damaged cord or plug, if it is not working properly, or if it has been damaged or dropped.
9. This appliance should be serviced only by qualified service personnel. Contact the nearest authorized service facility for examination, repair or adjustment.
10. Do not cover or block any openings on this appliance.
11. Do not use outdoors.
12. Do not immerse cord or plug in water.
13. Keep cord away from heated surfaces.
14. Do not let cord hang over edge of table or counter.
15. When cleaning surfaces of door and oven that meet when the door closes, use only mild, nonabrasive soaps or detergents with a sponge or soft cloth.
16. To reduce the risk of fire in the oven cavity:
 - (a) Do not overcook food. Carefully attend appliance if paper, plastic, or other combustible materials are placed inside the oven when cooking food.
 - (b) Remove wire twist-ties from bags before placing bag in oven.
 - (c) If materials inside the oven should ignite, keep oven door closed, turn oven off, and disconnect the power cord, or shut off power at the fuse or circuit breaker panel.
17. Do not use this appliance to heat corrosive chemicals (for example, sulfides and chlorides). Vapors from such corrosive chemicals may erode the contacts and springs of the safety interlock switches and render them inoperable.
18. The contents of feeding bottles and baby jars must be stirred or shaken and the temperature is to be checked before consumption to avoid burns.

SAVE THESE INSTRUCTIONS

General Use

Listed below are, as with all appliances, certain rules to follow and safeguards to assure top performance from this oven:

1. Do not use the oven for any reason other than food preparation, such as for drying clothes, paper, or any other nonfood items or for sterilizing purposes. They may catch on fire.
2. Do not use the oven when empty, this could damage the oven.
3. Do not use the oven cavity for any type of storage, such as papers, cookbook, cookware, etc.
4. Do not operate the oven without the turntable tray in place. Be sure it is properly sitting on the rotating base.
5. Be caution when removing the turntable tray after cooking meats that may have caused an accumulation of grease in the tray.
6. Unlike microwave-only ovens, this oven may become hot on the cabinet and oven door. Always use hot pads or oven mitts when placing or removing food and/or accessories from the oven. Be cautions about touching parts other than control panel during or immediately following grill or combination cooking.
7. If the oven is hot from combination cooking, do not use plastic or Styrofoam cookware for microwave cooking. They may melt.
8. Do not use recycled paper products for cooking. They may contain impurities which could cause sparks and/or fires when used during cooking.
9. Do not continue to cook with metal utensils if sparking appears. See "Accessories" section on page 6 for proper use of cookware.
10. Do not leave the oven unattended during short cooking times. Overcooking and fire may result.
11. Do not cook eggs in the shelf, as they will explode. Occasionally a poached egg may burst during microwave cooking. Be sure to cook covered, and let stand one minute after cooking before removing the cover.
12. Do not cook any food surrounded by a membrane, such as egg yolks, potatoes, chicken livers, etc., without first piercing them several times with a fork.
13. Do not pop popcorn except in a microwave approved popcorn bag or in a commercial package recommended especially for microwave ovens. Never try to popcorn in a paper bag. If oil is used while making popcorn, overcooking may cause smoke and, eventually, fire.
14. Do not attempt to operate this appliance with the door open.
15. Do not attempt to remove covers, panels, etc.
16. Look at the oven from time to time when food is heated or cooked in disposable containers of plastic, paper or other combustible materials.
17. If smoke is observed, switch off or unplug the appliance and keep the door closed in order to stifle any flames.
18. Microwave heating of beverages can result in delayed eruptive boiling, therefore care has to be taken when handling the container.

TO AVOID EXPLOSION AND SUDDEN BOILING

WARNING

When heating liquids, e.g. soups, sauces and beverages in your microwave oven, overheating the liquid beyond boiling point can occur without evidence of bubbling: This could result in a sudden boil over of the not liquid. To prevent this possibility the following steps should be taken:

- a. Avoid using straight sided containers with narrow necks.
- b. Do not overheat.
- c. Stir the liquid before placing the container in the oven and again halfway through the heating time.
- d. After heating, allow to stand in the oven for a short time, stir or shake them again carefully and check the temperature of them before consumption to avoid burns (especially, contents of feeding bottles and baby food jars).

WHICH UTENSIL CAN BE USED IN THE OVEN?

Before use, the user should check that utensils are suitable for use in microwave ovens.

Material	Grill & Convection cooking	Microwave cooking	Combined cooking
Glass (general)	No	Yes (1)	No
Glass (heat resistant)	Yes	Yes	Yes
Glass-ceramic and ceramic (heat resistant)	Yes	Yes (1)	Yes (1)
Earthenware	Yes	Yes	Yes
China (heat resistant)	Yes	Yes	Yes
Plastic (general)	No	Yes (2)	No
Plastic (heat resistant)	Yes (2)	Yes (2)	Yes (2)
Aluminium foil containers /aluminium foil	Yes	Yes (3)	Yes
Metal baking tins	Yes (4)	No	Yes (4)
Metal (pots.pans, etc)	Yes	No	No
Paper	No	Yes	No

1. Without metal parts or metal trims.
2. Some plastics are heat-proof only to certain temperatures. Check carefully!
3. It is possible to use aluminium foil to shield delicate areas of food (this prevents over-cooking).
4. Metal tins can be used in the combination methods, however if these are very deep, they will greatly reduce the efficiency, as metal shields the microwave energy from the food.

Microwave function only

Utensils and cooking containers used in a microwave oven should be of a material that does not act as a barrier to microwave energy. Generally this means that you should cook in either (paper), plastic, glass or ceramic. Metal pans reflect microwave energy and inhibit cooking, and should not be used. In addition to material, the shape of the container should also be considered. Round oval shapes give the most even cooking. Square or rectangular containers may over-cook foods in the corners because more energy is absorbed there. Shallow containers give more even cooking results.

1. Eggs

Never cook eggs in their shells. Steam will build up inside the shell during cooking and the egg will explode.

If you want to cook or reheat eggs which have not been broken up by scrambling or mixing, you must always pierce the yolks or these will also explode. You should slice shelled hard boiled eggs before you reheat them in your microwave oven.

2. Piercing

Always pierce food which has a skin or membrane, for example, potatoes, tomatoes, apples, sausages etc. If you don't pierce them, steam will build up inside and they may explode.

3. Lids

Always remove the lids of jars and containers and take away food containers, before you cook using your microwave oven. If you don't, then steam and pressure might build up inside and cause an explosion even after the microwave cooking has stopped.

Utensils made of china and ceramic excellent to use in your microwave oven. Most types of glass are also very good. Lead crystal glass can crack and should therefore, not be used. Plastics and paper can also be used, provided they can withstand the temperature of the heated food. For cooking only use plastics, which will withstand a temperature of over 120°C, e.g. polypropene and polyamide. Some plastic materials, e.g. melamine, will be heated by the microwave, and be damaged. To find out if a certain container is suitable, the following simple test can be made:

Place the empty container and a glass of water inside the microwave oven. The water is needed because the oven must not be operated empty or with empty containers only. Let the oven work on full power for one minute. A suitable container will only be lukewarm.

Metal containers, e.g. saucepans or frying pans should not be used in microwave ovens. Nor should plates or vessels with decorations be used since metal e.g. gold, might be part of the decoration and such decorations will be damaged.

Small pieces of aluminium foil can be used, but only to shield the areas that would over-cook (e.g. for covering chicken

wings, leg tips and fish tails) but the foil must not touch the side of the oven as damage may occur.



Caution:

- There are a number of accessories available on the market. Before you buy, make sure they are suitable for microwave use.
- When you put food in the microwave oven, make sure that food, food supports or covering do not come in direct contact with any of the internal walls or the ceiling of the cavity since discolouration may take place.

CONTROL PANEL

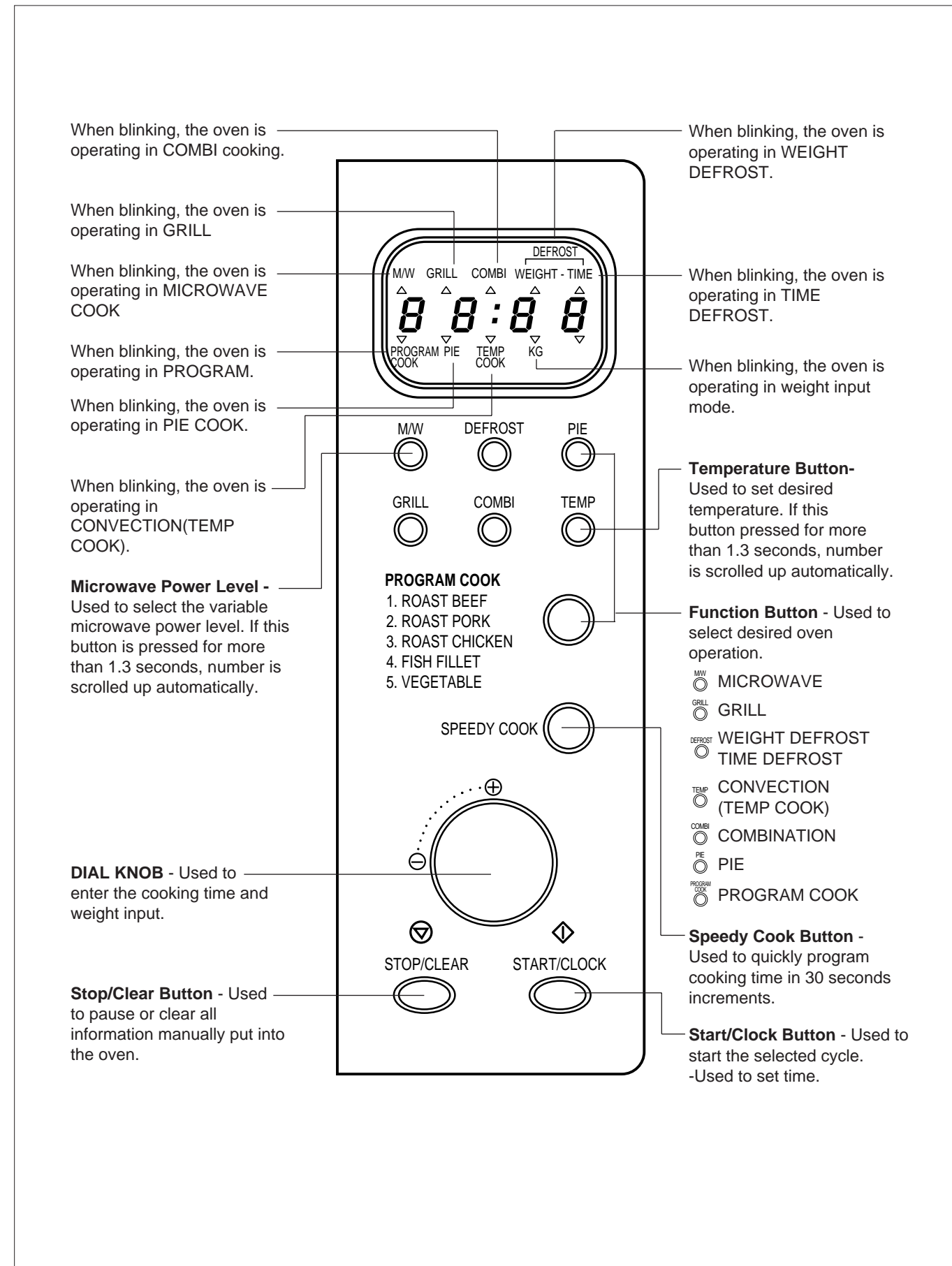

ACCESSORIES

This oven comes equipped with several accessories. They can be used in various ways to facilitate cooking. Be sure to follow specific directions for their use when given in charts or recipes in the cookbook.

§ Rotating base

This fits over the shaft in the center of the oven's cavity floor. This is to remain in the oven for all cooking. It should only be removed for cleaning.

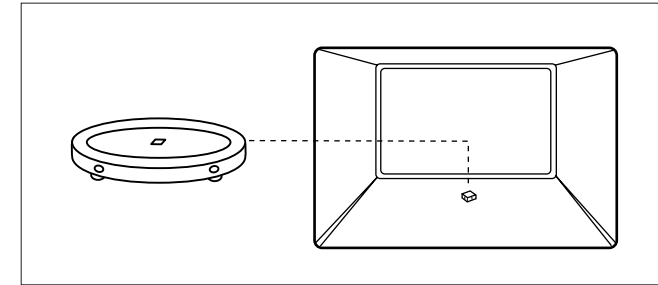

Important:

The rotating base must be placed in the center of the oven's cavity and fitted in the rotating shaft exactly. In case the rotating base does not fit in the rotating shaft, the rotating base might become as tray and sparks can occur.

§ Turntable tray or turntable

This metal tray fits over the rotating base and locks into place.

This is to be used in the oven for all cooking. It rotates clockwise or counterclockwise during cooking. It is easily removable for cooking and cleaning needs.

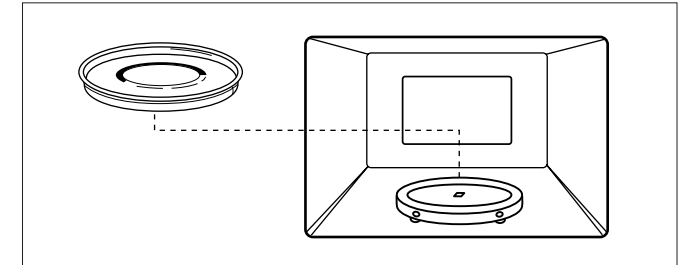

§ Metal rack

This metal rack is used with the turntable tray.

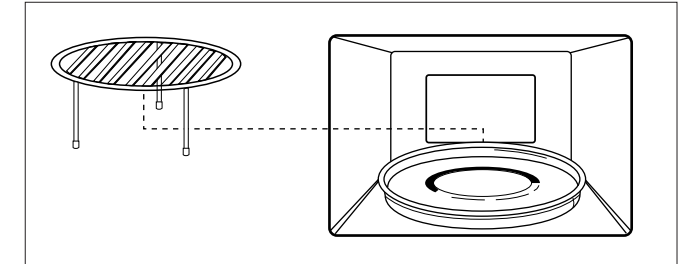

§ HOW TO USE THE ACCESSORIES OF COOKING

§ Turntable

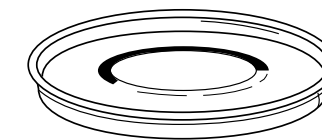

f MICROWAVE COOKING
f CONVECTION COOKING
f COMBI. COOKING

§ Metal rack

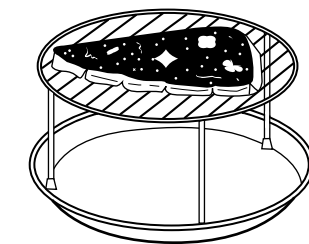

f GRILL COOKING

HOW TO SET THE OVEN CONTROLS

Tips:

- Be sure to read the cookbook's introduction before operating the oven.
- Also remember to read this operating instruction for proper safety information and instruction before using the oven.
- See the cookbook for specific recipes.
- Prior to setting the controls, place one cup of water in the oven, on a heat-proof glass measuring cup, for testing purposes.

Note:

- The time setting has an interval of 10 seconds from 10 seconds to 5 minutes, 30 seconds from 5 minutes to 15 minutes, 1 minute from 15 minutes to 30 minutes. 2 minutes from 30 minutes to 60 minutes.
- At the end of each cooking, the cooling fan will run for time 5 minutes to cool the oven. (The display will show "cool" then the  button is pressed after cooking.) However, you can proceed with further cooking immediately even in this stage.

§ CHILD LOCK

To prevent child from operating the oven, install the childlock key.

1. Press  button for 3 seconds. "Loc" will show in the display and all buttons do not operate.
2. Press stop button for 3 seconds once again, then childlock is canceled.

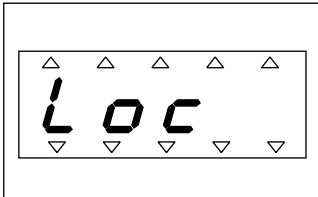

§ CLOCK



This is a 24(12) hours clock.

When the oven is plugged in, "0" appears in the display window. The time of day will be displayed at all times, except when the oven is operating.

In case of a power failure or if the oven is unplugged, the clock has to be reset for the proper time. Once power is restored or the oven is plugged in, the display will show "0".

SETTING THE CONTROLS

Example: 4:35

1. Press  button for 3 seconds. Select 24Hr or 12Hr. (24Hr or 12Hr can be selected alternatively as the  button is pressed in sequence.)

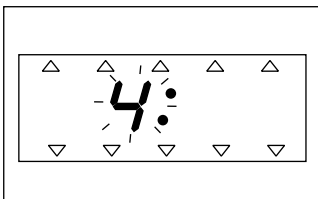

2. Turn the DIAL KNOB for hour you want.

Note:

- Hour is blinking.

3. Press  Button.

4. Turn the DIAL KNOB for minute you want.

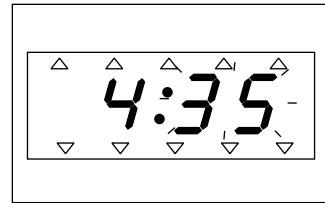

Note:

- Minute is blinking.

5. Press  buttons.

§ MICROWAVE COOKING

Note:

- To insure the best microwave and defrost results, be sure to start with a cool oven. This is important if grill, convection, or combination was used prior to microwave cooking. The cooling fan will run for 5 minutes after the end of cooking.
- The variable power Level settings equal the following wattage.

DISPLAY	POWER LEVEL	DISPLAY	POWER LEVEL
P-HI	100%	P-90	90%
P-80	80%	P-70	70%
P-60	60%	P-50	50%
P-40	40%	P-30	30%
P-20	20%	P-10	10%

SETTING THE CONTROLS

1. Press  button. The display will show "P-HI". This oven has 10 power levels from P-HI to P-10.

2. Press the  button to select the desired microwave power level.

For example: power level 80

Press  button two times more.

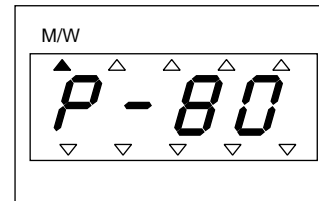

3. Turn the DIAL KNOB for the desired cooking time.

For example: 18minutes
Turn right or left the DIAL KNOB. Then, 18:00 will show in the display. Time can be set up from 10 seconds to 60 minutes

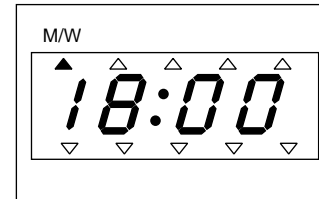

Note:

- If step 2 is omitted, the oven will cook at full power.

4. Press  button.



The oven will now start microwave cook for 18 minutes at power level P-80.

5. Four beeps will sound at the end of the cooking time.

The indicator light will go off. The display panel will return to the time of day. The oven light will turn off and the turntable will stop turning.

Note:

CHANGING THE CONTROLS DURING THE OVEN OPERATION

1. Press  button. The display will show the current power level.
2. Press  button again to change the power level.

(If  button is not pressed within 3 seconds, the display will show the operation mode.)

Note:



- After the end of microwave cooking, the cooling fan will run for 5 minutes.

§ TIME DEFROST

Note:

- During the defrosting operation, turn the food over after you hear 4 times of 4 beeps for complete defrost.

SETTING THE CONTROLS

1. Press  button twice.
2. Turn the DIAL KNOB for the desired defrosting time.
3. Press  button.
4. Four beeps will sound at the end of the cooking time.

For example: 18 minutes

Time can be set up from 10 seconds to 60 minutes.

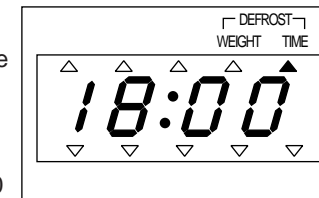

The indicator light will go off. The display panel will return to the time of day. The oven light will turn off and the turntable will stop turning.

Note:

- When the selected operation is over, a cooling fan will run for 5 minutes.

§ WEIGHT DEFROST

Note:

- This mode allows you to set weight from 0.1kg to 2.9kg
- During the defrosting operation turn over the food after 4 beeps sound 4 times for complete defrosting.

SETTING THE CONTROLS

1. Press  button.

2. Turn the DIAL KNOB for the desired defrosting weight.

For example: 2.3kg

3. Press  button.

4. The display will show the defrosting time.

5. Four beeps will sound at the end of the cooking time.

The indicator lights will go off. The display panel will return to the time of day. The oven light will turn off and the turntable will stop turning.

Note:

- When the selected operation is over, a cooling fan will run for 5 minutes.

§ GRILL COOKING

SETTING THE CONTROLS

1. Press  button.

Note:

- The heating element is located in the top of the oven.

2. Turn the dial knob for the desired cooking time.

For example: 25 minutes
Time can be set up from 10 seconds to 60 minutes.

3. Press  button.

4. Four beeps will sound at the end of the cooking time.

The indicator light will go off. The display panel will return to the time of day. The oven light will turn off and the turntable will stop turning.

To use:

- Place food on Metal Rack.
- Place the Metal Rack directly on the Turntable.
- While Grilling, be careful as the trays will be hot to the touch. Use oven mitts while handling trays.
- Never touch the oven window and metal interior of the oven when taking food in and out. The temperature inside the oven and door is quite high.
- Do not open the door so often, the temperature inside the oven decrease and the cooking may not complete in the setting time.

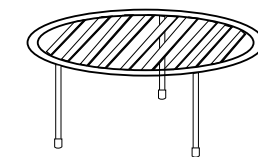

METAL RACK



TURNTABLE

Note:

- When the selected operation is over, a cooling fan will run for 5 minutes.

§ CONVECTION COOKING

Note:













- This oven can be set between a minimum temperature of 100°C and a maximum temperature of 210°C.
- The heating elements are locked in the top and under of the oven.

SETTING THE CONTROLS

1. Press  button.

Press the  button

for the desired temperature.

100; ; ; 
 130; ; ; 
 160; ; ; 
 190; ; ; 

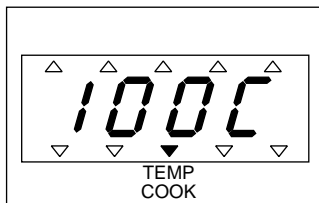

2. Turn the DIAL KNOB for the desired cooking time.

For example: 18 minutes

Time can be set up from 10 seconds to 60 minutes.

3. Press  button.

The oven will now start convection cooking for 18 minutes at the desired temperature.

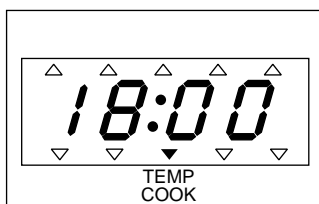

4. Four beeps will sound at the end of the cooking time.

The indicator light will go off. The display panel will return to the time of day.
 The oven light will turn off and the turntable will stop turning.

Note:

- When the selected operation is over, a cooling fan will run for 5 minutes.
- You can check the preset temperature during the oven operation by pressing . The preset temperature shown in the display will change into the cooking time after 3 seconds.













§ PRE-HEAT

Note:

- This oven can be set between a minimum temperature of 100°C and a maximum temperature of 210°C.
- This function must be used without the food inside the oven (before the food is placed in the cavity).
- The food must be placed after the preheating is over.

SETTING THE CONTROLS

1. Press  button.

Press the  button for
 100; ; ; 
 130; ; ; 
 160; ; ; 
 190; ; ; 

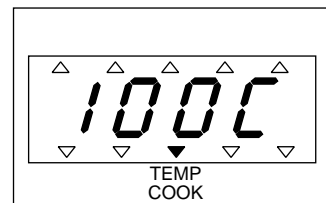

For example: 100°C

2. Press  button.

Temperature of preheating and "PrE-" blink alternatively in the display.

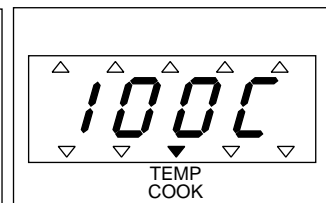
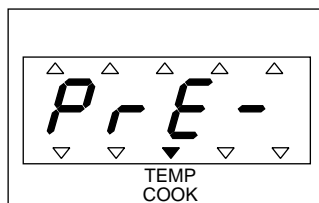

3. □ When preheating is completed, four beeps will sound four times.

□ Then, temperature of preheating blinks.

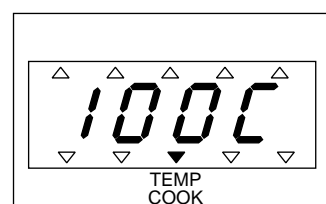

4. Open the door and place the food inside oven. Then, close the door of the oven and set the desired cooking time.

For example: 18 minutes

5. Press  button.

The oven will now start convection cooking for 18 minutes at 100°C. Four beeps will sound at the end of the cooking time.

The indicator light will go off. The display panel will return to the time of day. The oven light will turn off and the turntable will stop turning.

Note:

- When the selected operation is over, a cooling fan will run for 5 minutes.
- After preheating, you should cook immediately.
- The preheated condition will last for 15 minutes at maximum then stop to protect the oven.

§ COMBI COOKING

Note:

- Microwave and top heater operate simultaneously (of sequentially) in this mode.
- This oven can be set between a minimum temperature of 100°C and a maximum temperature of 210°C.

f Simultaneous Operation only.

DISPLAY	POWER LEVEL
C-0	50%
C-Hi	70%
C-Lo	30%

(Above percentage in the power level indicates power level of microwave output)

SETTING THE CONTROLS

1. Press  button.

"C-0" will show in the display.

2. Select the desired power level.







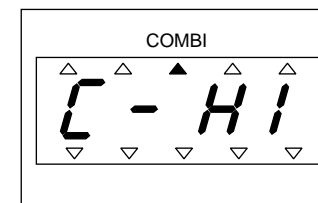



For example: C-HI

Press  button once again.

"C-HI" Will show in the display.



3. Press the  button for the desired temperature.

100; ; ; ; ; ; 
 170; ; ; ; ; 

4. Turn the DIAL KNOB for the desired cooking time.

5. Press  button.













(f Sequential Operation Only)

SETTING THE CONTROLS

1. Press  button.

"C" will show in the display.

2. Press the  button for the desired temperature.

100; ; ; 
 130; ; ; 
 160; ; ; ; ; ; 

3. Turn the DIAL KNOB for the desired cooking time.

4. Press  button.

Four beeps will sound at the end of the cooking time. The indicator light will go off. The display panel will return to the time of day. The oven light will turn off and the turntable will stop turning.

§ PROGRAM COOK

Note:

- When the selected operation is over, a cooling fan will run for 5 minutes.
- You can check the preset temperature during the oven operation by pressing . The preset temperature shown in the display will change into the cooking time after 3 seconds.

Note:

- When using COMBI mode, please refer to cooking guide.
- When cook a large piece of food (e.g. Chicken, roast pork, etc.) steam or water droplets may leak from the door surround.
- This emissions do not mean that the oven is faulty.

SETTING THE CONTROLS

Note:

- There is preprogrammed cooking of five menu. (1-5)
- Don't need to set cooking time, power or function.

1. Press  button

Then, "AC-1" will show in the display.

2. Select the desired cooking menu.

For example: roast pork.

Press  button once

again then "AC-2" will show in the display.

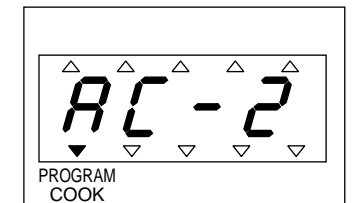

3. If you want to select other cooking, touch the button again, until display shows your desired menu.

4. Press  button.

The oven will now start programmed cook for menu 2. The cooking time of the menu 2, roast pork, is 37 minutes.

5. The display will show the cooking time

6. Four beeps will sound at the end of the cooking time. The indicator light will go off. The display panel will return to the time of day. The oven light will turn off and turntable will stop turning.

Note:

- The menu of pre-programmed cooks equal to the following
 - AC-1 ROAST BEEF (1.3Kg)
 - AC-2 ROAST PORK (1.3Kg)
 - AC-3 ROAST CHICKEN (1.3Kg)
 - AC-4 FISH FILLET (450g)
 - AC-5 VEGETABLE (450g)
- See the cooking guide for specific recipes.



§ **TO INTERRUPT THE COOKING CYCLE DURING OPERATION-open the door or press stop/clear button.**

1. The oven will immediately stop.
2. The cooling fan will run for 5 minutes.
3. If no further cooking required, press STOP/CLEAR button.
4. The time of day is displayed. If you press stop/clear button during cooling time, the "cool" is displayed.
5. To continue cooking, close the oven door and press  button. The oven will restart.

§ **GENERAL COOKING HINTS**

1. When cooking a roast with an excess amount of fat, it is helpful to remove the fat at turnove times to prevent pattering.
2. Prick the meats, fish or poultry with a fork to prevent bursting. Steam builds up pressure in meals, fish or poultry which is tightly covered by a skin or membrane.
3. Reduce suggested cooking times. It is always better to under-cook foods rather than to overcook them. If a range of times is stated in a recipe, cook the food at the minimum suggested time, check for doneness, and then cook slightly longer if necessary.

§ **PIE COOK** 

1. Press  button. "PIE" will show in the display.
2. Turn the DIAL KNOB for the desired cooking time.
3. Press  button.

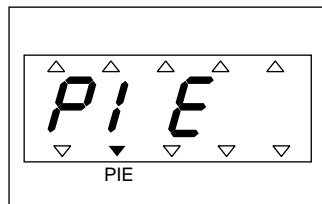

4. Four beeps will sound at the end of the cooking time. The indicator light will go off. The display panel will return to the "time of day". The oven light will turn off and the turntable will stop turning.

Note:

- When the operation is over, a cooling fan will run for 5 minutes.

§ **SPEEDY COOK** 

Note:

- The cooking time increases by 30 seconds from 30 seconds to 5 minutes.

SETTING THE CONTROLS

1. Press  button.
2. " :30" will appear in the display window.
3. Whenever this button is pressed, cooking time is increased by 30 seconds.

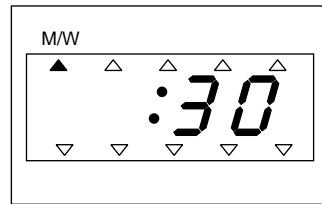

4. If the time was set this oven will operate automatically after 2 seconds.
5. Four beeps will sound at the end of the cooking time. The indicator light will go off. The display panel will return to the time of day. The oven light will turn off and the turntable will stop turning.

GENERAL GUIDE LINES

Since microwave cooking to some extent is different from traditional cooking, the following general guidelines should be considered whenever you use your microwave oven

If the food is undercooked

Check if:

- You have selected the correct power level.
- The selected time is sufficient-the times given in the recipes are approximate. They depend on initial temperature, weight and density of the food etc.
- The container is appropriate.

If the food is overcooked,i.e. dried out or burnt

Before you cook again, consider whether:

- The power level was too high.
- The set time was too long-the times in the recipes are approximate. They depend on initial temperature, weight and density of the food etc.

Points to remember when defrosting

- The shape of the package alters the defrosting time. Shallow rectangular packets defrost more quickly than a deep block. Separate pieces as they begin to defrost; freef low slices defrost more easily.
- Shield areas of food with small pieces of foil if they start to become warm.
- When defrosting, it is better to under thaw the food slightly and allow the process to finish during the standing time.

The amount of food

The more food you want to prepare the longer it takes. A rule of thumb is that double amount of food requires almost double the time. If one potato takes four minutes to cook, approximately seven minutes are required to cook two potatoes.

Starting temperature of food

The lower the temperature of the food which is being put into the microwave oven, the longer time it takes. Food at room temperature will be reheated more quickly than food at refrigerator temperature.

Composition of the food

Food with a lot of fat and sugar will be heated faster than food containing a lot of water. fat and sugar will also reach a higher temperature than water in the cooking process. The more dense the food, the longer it takes to heat. Very dense" food like meat takes longer time to reheat than lighter, more porous food like sponge cakes.

Size and shape

Smaller pieces of food will cook more quickly than larger pieces and uniform pieces of food cook more evenly than irregularly shaped foods. With unevenly shaped food, the thinner parts will cook faster than the thicker areas. Place the thinner chicken wings and legs to the centre of the dish.

Stirring, turning of foods

Stirring and turning of foods are techniques used in conventional and well as in microwave cooking to distribute the heat quickly to the centre of the dish and avoid over-cooking at the outer edges of the food.

Covering food helps:

- To reduce spattering
- To shorten cooking times
- To retain food moisture

All covering, which will allow microwaves to pass through are suitable-See above; Which utensils can be used in the oven? ; -

Releasing pressure in foods

Several foods are tightly covered by a skin or membrane. These foods should be pricked with a fork or cocktail stick to release the pressure and to prevent bursting, as steam builds up within them during cooking. This applies to potatoes, chicken livers, sausages, egg yolks and some fruits.

Standing time

Always allow the food to stand for some time after using the oven. standing time after defrosting, cooking/reheating always improves the result since the temperature will then be evenly distributed through out the food.

In a microwave oven foods continue to cook even when the microwave energy is turned off. They are no longer cooking by microwaves, but they are still being cooked by the conduction of the high residual heat to the centre of the food. The length of standing time depends on the volume and density of the food. Sometimes it can be as short as the time it takes you to remove the food from the oven and take it to the serving table. However, with larger, denser foods, the standing time may be as long as 10 minutes. During ; standing ; the internal temperature of the food will rise by as much as 8 ; and the food will finish cooking in this time.

Arranging food

This is done in several ways in microwave cooking to give more even cooking results.

If you are cooking several items of the same food such as jacket potatoes, place them in a ring pattern for uniform cooking. When cooking foods of uneven shapes or thickness, place the smaller or thinner area of the food towards the centre of the dish where it will be heated last.

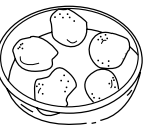

Uneven foods such as fish should be arranged in the oven with the tails to the centre.

If you are saving a meal in the refrigerator or ; plating ; a meal for reheating, arrange the thicker, denser foods to the outside of the plate and the thinner or less dense foods in the middle.

Place thin slices of meat on top of each other or interlace them. Thicker slices such as meat loaf and sausages have to be placed close to each other. Gravy or sauce should be reheated in a separate container.

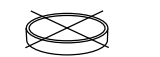
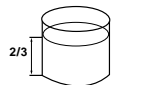

Choose a tall, narrow container rather than a low and wide container. When reheating gravy, sauce or soup, do not fill the container more than 2/3.

When you cook or reheat whole fish, score the skin this prevents cracking. Shield the tail and head with small pieces of foil to prevent over-cooking but ensure the foil does not touch the sides of the oven.



KEEP THE OVEN CLEAN

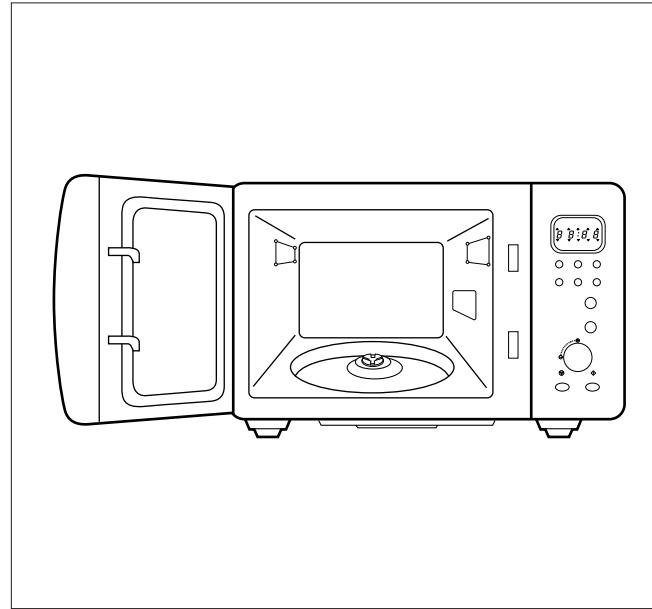

TURNTABLE AND ROTATING BASE

These two parts are easily removable for cleaning. The turntable should be cleaned frequently and is dishwasher proof.

If food spills are accumulated under the rotating base, the oven will not operate efficiently. Be sure to wipe up any spills as they occur in this area.

Clean these parts as described in by the same method of cleaning inside the oven. Be sure to properly reinstall these parts into the cavity after cleaning.

Note:

Do not use any other Turntable in the oven. Do not operate the oven without the Turntable and Rotating Base Properly in place.

DOOR

While the oven door is still warm, any spatters or food soils should be wiped off with a damp sudsy cloth or sponge. Rinse with water and wipe dry with a cloth.

If steam or condensation appears around this area, wipe with a cloth. This may occur when the oven is operating under high humidity and with foods containing lots of moisture. This is a normal part of microwave cooking.

EXTERIOR

CONTROL PANEL

Excercise care when cleaning this area. To clean, wipe the panel with a slightly dampened cloth, using only water. Wipe dry. Do not scrub this area or use any sort of chemical cleaner. Avoid use of excess water.

OUTSIDE SURFACE

The outside surfaces should be cleaned with soap and water, rinsed and dried with a soft cloth. Do not use any type of household or abrasive cleanser.

Note:

- DO NOT USE ANY TYPE OF OVEN CLEANER ON ANY PART OF THE OVEN. It will damage some of the interior and exterior surfaces of the oven.
- In order to keep the good condition of your oven, clean the inside after each cooking.

INSIDE THE OVEN

The interior three side walls and floor are stainless steel. For easy cleaning, wipe spills and spatters as they occur with a damp cloth or sponge with water and a mild detergent. Rinse the cavity of any cleaning residue with a clean damp or sponge after cleaning. Dry with a soft cloth.

These areas can also be cleaned by using plastic or nylon scouring pads recommended for use of Teflon and Silverstone*.

For hard to remove soil, use a mild non-abrasive cleaner. Use on the stainless steel areas, turntable and rotating base only.

FLOOR

A grill element is installed under the floor, and there are holes on the floor over the grill. Therefore, you must be very careful not to drop any waterdrops or spills over the holes. Do not wipe the holed-surface with a damp cloth or detergent Only use soft, clean and dry cloth.

When you clean the groove or floor with a damp cloth, you need to be careful not to touch the holed-surface.

TOP SURFACE

Two quartz grill elements are installed on the top surface. As they are fragile, be careful not to press or grip them hard. Do not remove the grill elements to clean the surface.

Warning

Just as your traditional oven becomes hot also this oven will become hot during use of the grill functions or in combination with microwaves. children should be supervised at all times when using the oven.

BEFORE CALLING FOR SERVICE

You can often correct operating problems yourself. If your microwave/grill oven fails to work properly, locate the operating problem in the chart below and try the solutions marked for each problems.

If the microwave/grill oven still does not work properly, contact the nearest Service Center.

Note:

It is quite normal for steam to be emitted around the door during the cooking cycle. The door is not intended to seal the oven cavity completely but its special design contributes to the complete safety of the appliance.

Caution:

1. Do not attempt to operate the oven while empty as this will cause damage.
2. As an exhaust is located in the rear of the oven, install the oven so as not to block the outlet.
If the microwave/grill oven still does not work properly, contact the nearest Service Center.

PROBLEM

Oven will not start	X	X	X	X										
Arcing or sparking					X	X								
Unevenly cooked foods					X		X	X	X					
Overcooked foods										X				
Undercooked foods					X				X	X	X			
Improper defrosting					X		X	X		X			X	

SOLUTION

- Is start button pressed? —
- Is power cord plugged in? —
- Is door closed? —
- Set the cooking time. —
- Use approved cookware only. —
- Do not operate with oven empty. —
- Supplied tray must be used. —
- Turn of stir food. —
- Completely defrost food. —
- Turn correct dial knob / Press correct Function buttons —
- Check to see that oven ventilation parts are not blocked. —
- Open the door slightly and wait 10~15min. for cooling. —

QUESTIONS AND ANSWERS

Q: I accidentally ran my microwave oven without any food in it. is it damaged?

A: We do not recommend to operating the microwave oven without any food. However, running the oven empty for a SHORT time will not damage the oven.

Q: Can I open the door when the oven is operating?

A: The door can be opened anytime during the oven operation. Microwave energy will be instantly switched off and the time setting will maintain until the door is closed.

Q: Does microwave energy pass through the viewing screen in the door?

A: No. The metal screen bounces back the energy to the oven cavity. The holes are made to allow light to pass through. They do not let microwave energy pass through.

Q: My microwave oven causes interference with my TV. is this normal?

A: Some radio and TV interference might occur when you cook with the microwave oven. This interference is similar to the interference caused by small appliances such as mixers, vacuums, blow dryers, etc. It does not indicate a problem with your oven.

Q: How can we know whether the oven is operating or not?

A: Oven is operating only when the door is closed. After the end of oven cooking, the cooling fan will run for two minutes.

Q: Why does my oven light dim?

A: When cooking at reduced power level, the oven must cycle to obtain the selected power levels. The oven light, dims and clicking noises can be heard when the oven cycles.

Q: When is the oven light on and off?

A: The oven light is on during the cooking time and when the door is opened.

Q: Why does steam accumulate on the oven door?

A: During cooking, steam is given off from the food. Most of the steam is removed from the oven by the air which circulates in the oven cavity. However, some steam will condense on cooler surfaces such as the oven door. This is normal.

Q: Sometimes warm air comes from the oven vents. Why?

A: The heat given off from the cooking food warms the air in the oven cavity. This warmed air is carried out of the oven by the air flow pattern in the oven. There are no microwave in the air. The oven vents should never be blocked during cooking.

Q: Why does the smoke come out of the exhaust vent at the back of oven?

A: It is normal for smoke to come out of the vents during cooking. Smoke may be produced when food is overcooked.

SPECIFICATIONS

Power supply	230V~, 50Hz	
Microwave	Power consumption	1450W
	Output power	1000W (IEC 705)
	Frequency	2,450MHz
Grill power consumption	1200W	
Convection power consumption	1550W	
Combination heating power consumption	2600W(Simultaneous) / 1850W(Sequential)	
Outside Dimension(WXDXH)	526(20.7)X496(19.5)X345(13.6)mm (inch)	
Cavity Dimensions(WXDXH)	335(13.2)X339(13.3)X250(9.8)mm (inch)	
Net Weight	Approx. 21.0Kg (46.3 lbs)	
Timer	60 minutes	
Select function	Microwave / Grill / Convection / Combination	
Microwave power level	10 stages	

Free Manuals Download Website

<http://myh66.com>

<http://usermanuals.us>

<http://www.somanuals.com>

<http://www.4manuals.cc>

<http://www.manual-lib.com>

<http://www.404manual.com>

<http://www.luxmanual.com>

<http://aubethermostatmanual.com>

Golf course search by state

<http://golfingnear.com>

Email search by domain

<http://emailbydomain.com>

Auto manuals search

<http://auto.somanuals.com>

TV manuals search

<http://tv.somanuals.com>