

DAEWOO

MICROWAVE OVEN

KOR-61A5

OPERATING
INSTRUCTIONS

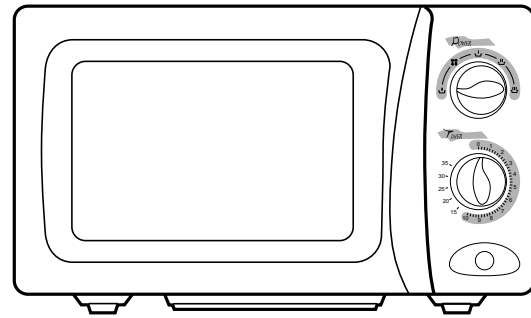

Before operating this oven, please
read these instructions completely.

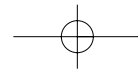

PRECAUTIONS TO AVOID POSSIBLE EXPOSURE TO EXCESSIVE MICROWAVE ENERGY

- (a) Do not attempt to operate this oven with the door open since open-door operation can result in harmful exposure to microwave energy. It is important not to defeat or tamper with the safety interlocks.
- (b) Do not place any object between the oven front face and the door or allow soil or cleaner residue to accumulate on sealing surfaces.
- (c) Do not operate the oven if it is damaged. It is particularly important that the oven door close properly and that there is no damage to the: (1) door (bent), (2) hinges and latches (broken or loosened), (3) door seals and sealing surfaces.
- (d) The oven should not be adjusted or repaired by anyone except properly qualified service personnel.

TABLE OF CONTENTS

PRECAUTIONS TO AVOID POSSIBLE EXPOSURE TO EXCESSIVE MICROWAVE ENERGY 1

TABLE OF CONTENTS 1

EARTHING INSTRUCTIONS 2

INSTALLATION 2

SPECIFICATIONS 3

IMPORTANT 3

SAFETY INSTRUCTIONS FOR GENERAL USE 4

FEATURES DIAGRAM 5

OPERATION 6

COOKING UTENSILS 6

CARE AND CLEANING 7

BEFORE YOU CALL FOR SERVICE 7

QUESTIONS AND ANSWERS 7

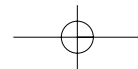

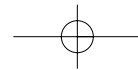

EARTHING INSTRUCTIONS

This appliance must be earthed. In the event of an electrical short circuit, earthing reduces the risk of electric shock by providing an escape wire for the electric current. This appliance is equipped with a cord having a earthing wire with a earthing plug. The plug must be plugged into an outlet that is properly installed and earthed.

WARNING: Improper use of the earthing plug can result in a risk of electric shock. Consult a qualified electrician or serviceman if the earthing instructions are not completely understood, or if doubt exists as to whether the appliance is properly earthed. If it is necessary to use an extension cord, use only a 3-wire extension cord that has a 3-blade earthing plug, and a 3-slot receptacle that will accept the plug on the appliance. The marked rating of the extension cord should be equal to or greater than the electrical rating of the appliance.

INSTALLATION

- 1 Steady, flat location**
This oven should be set on a steady, flat surface. This oven is designed for counter top use only.
- 2 Leave space behind and side**
All air vents should be kept a clear. If any vents are covered during operation, the oven may overheat and, eventually, the oven fail.
- 3 Away from radio and TV sets**
Poor television reception and radio interference may result if the oven is located too close to a TV, Radio antenna, feeder and so on.
Position the oven as far from them as possible.
- 4 Away from heating appliance and water taps**
Keep the oven away from hot air, steam or splashes when choosing a place to position it, or the insulation might be adversely affected and breakdowns occur.
- 5 Power supply**
 - Check your local power source. This oven requires a current of approximately 5 amperes, 230V 50Hz.
 - Power supply cord is about 1.1 meters long.
 - The voltage used must be the same as specified on this oven. Using a higher voltage may result in a fire or other accident causing oven damage. Using low voltage will cause slow cooking. We are not responsible for damage resulting from use of this oven with a voltage a ampere fuse other than those specified.
 - This appliance is supplied with a special type of cable, which, if damaged, must be repaired with cable of same type. Such a cable can be purchased from DAEWOO and must be installed by a Qualified Person.
- 6 Examine the oven after unpacking for any damage such as:**
A misaligned door, Broken door, A dent in cavity. If any of the above are visible, DO NOT INSTALL, and notify dealer immediately.
- 7 Do not operate the oven if it is colder than room temperature.**
(This may occur during delivery in cold weather.) Allow the oven to become room temperature before operating.

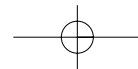

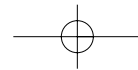

SPECIFICATIONS

POWER SUPPLY		230V~50Hz, SINGLE PHASE WITH EARTHING
MICROWAVE	POWER CONSUMPTION	1200 W
	OUTPUT POWER	800 W (IEC 705)
	FREQUENCY	2450 MHz
OUTSIDE DIMENSIONS (W X H X D)		465 X 275 X 374 mm
CAVITY DIMENSIONS (W X H X D)		290 X 200 X 290 mm
NET WEIGHT		APPROX. 13.5 Kg
TIMER		35 min. DUAL SPEED
POWER SELECTIONS		5 LEVELS

* Specifications subject to change without notice.

IMPORTANT

The wires in this mains lead are coloured in accordance with the following code.

Green-and-yellow : Earth
 Blue : Neutral
 Brown : Live

As the colours of the wires in the mains lead of this appliance may not correspond with the coloured markings identifying the terminals in your plug, proceed as follows:

The wire which is coloured green-and-yellow must be connected to the terminal in the plug which is marked with the letter 'E' or by the earth symbol or green-and-yellow. The wire which is coloured blue must be connected to the terminal which is marked with the letter 'N' or coloured black.

The wire which is coloured brown must be connected to the terminal which is marked with the letter 'L' or coloured red.

WARNING: This appliance must be earthed.

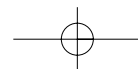

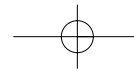

SAFETY INSTRUCTIONS FOR GENERAL USE

Listed below are, as with all appliances, certain rules to follow and safeguards to assure top performance from this oven:

1. Do not use the oven for any reason other than food preparation, such as for drying clothes, paper, or any other nonfood items or for sterilizing purposes.
2. Do not use the oven when empty, this could damage the oven.
3. Do not use the oven cavity for any type of storage, such as papers, cookbook, cookware, etc.
4. Do not operate the oven without the glass tray in place. Be sure it is properly sitting on the rotating base.
5. Make sure you remove caps or lids prior to cooking when you cook food sealed in bottles.
6. Do not put foreign material between the oven surface and door. It could result in excessive leakage of microwave energy.
7. Do not use recycled paper products for cooking. They may contain impurities which could cause sparks and/or fires when used during cooking.
8. Do not pop popcorn unless popped in a microwave approved popcorn popper or unless it's commercially packaged and recommended especially for microwave ovens. Microwave popped corn produces a lower yield than conventional popping; there will be a number of unpopped kernels. Do not use oil unless specified by the manufacturer.
9. Do not cook any food surrounded by a membrane, such as egg yolks, potatoes, chicken livers, etc., without first piercing them several times with a fork.
10. Do not pop popcorn longer than the manufacturer's directions. (popping time is generally below 3 minutes).
Longer cooking does not yield more popped corn, it can cause scorching and fire. Also, the cooking tray can become too hot to handle or may break.
11. Should the microwave oven emit smoke in quantity to indicate a fire, keep the oven door shut, switch the appliance off and disconnect the mains lead from the outlet.
12. When flammable food containers are used in the oven (eg packet popcorn) be sure to check the cooking process periodically in case fire has occurred.
13. Always stir and/or shake the containers of baby foods prior to testing their temperature and serving the contents.
14. Always test the temperature of food or drink which has been heated in a microwave oven before you give it to somebody, especially to children or elderly people. This is important because things which have been heated in a microwave oven carry on getting hotter even though the microwave oven cooking has stopped.
15. The contents of feeding bottles and baby food jars are to be stirred or shaken and that the temperatures to be checked before consumption to avoid burns.
16. Microwave cook chill meals in aluminium foil containers may be heated however be sure that the foil container is never closer than 2.5cm from the cavity walls or door in order to prevent oven damage.

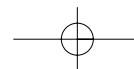

FEATURES DIAGRAM

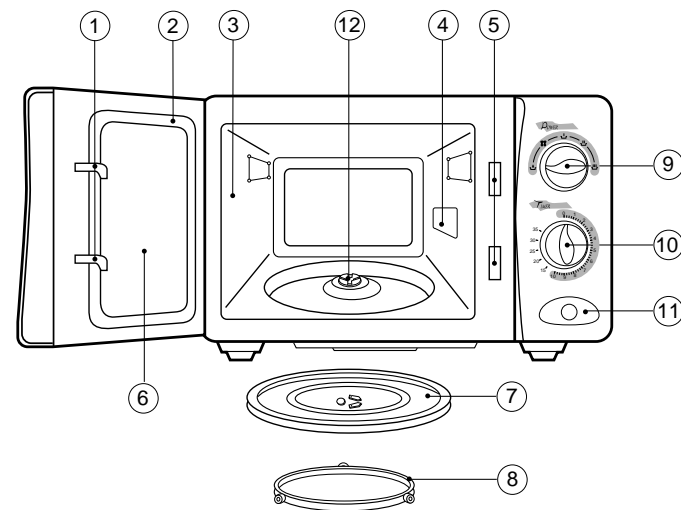

- ① **Door Hook** - When door is closed, it will automatically lock shut. If the door is opened while the oven is operating, magnetron will immediately stop operating.
- ② **Door Seal** - Door seal maintains the microwave energy within the oven cavity and prevents microwave leakage.
- ③ **Oven Cavity.**
- ④ **Spatter shield** - Protects the microwave outlet from splashes of cooking foods.
- ⑤ **Safety Interlock System.**
- ⑥ **Door Viewing Screen** - Allows viewing of food. The screen is designed so that light can pass through, but not the microwave.
- ⑦ **Glass Cooking Tray** - Made of special heat resistant glass. Food in a proper receptacle is placed on this tray for cooking.
- ⑧ **Roller guide** - This must always be used for cooking together with the glass cooking tray.
- ⑨ **Knob V.P.C** - Used to select a microwave power level.
- ⑩ **Knob timer** - Used in setting cooking time for all functions.
- ⑪ **Door Release Button** - By pushing this button the latch system cuts off all circuits and stops the oven before the door is opened.
- ⑫ **Coupler** - This fits over the shaft in the center of the oven's cavity floor. This is to remain in the oven for all cooking.

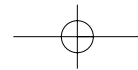

OPERATION

- 1 Connect the mains lead to an electrical outlet.
- 2 After placing the food in a suitable utensil, open the oven door and put it on the glass tray. Glass tray must always be in place during cooking.
- 3 Shut the door.
Make sure that it is firmly closed.
- 4 Set the variable power selector to the desired power level.

SYMBOL	POWER LEVEL	OUTPUT POWER
	WARM	17%
	DEFROST	37%
	MEDIUM	59%
	MED. HIGH	79%
	HIGH	100%

- 5 Set the time control by turning the timer knob and then microwave cooking starts.
 - If turning the timer knob for less than 2 minutes, turn it past 2 minutes and then back to the desired time.
- 6 Microwave energy will be turned off automatically when the timer points to "OFF". Then take out food.
 - To prevent the oven operating with the door open, your microwave oven is fitted with safety door interlock switches. If you wish to inspect the food during the cooking time, simply open the door. The oven will automatically stop cooking. To continue cooking, you simply close the door.
 - If you wish to stop cooking simply turn the timer knob to point "OFF". Cooking can be reset at any time during the cooking cycle by turning the timer knob.
 - Do not let the timer continue to operate after removing food.

COOKING UTENSILS

Microwave energy is produced by high frequency radio waves. They are reflected from metal, but will pass through most cooking utensils without heating them. As the waves come into contact with the food, they are converted into heat energy. Listed below are the suggested cooking utensils for this microwave oven and when to use them.

1. Dishes with metal trim of any type-should not be used. This will cause sparking.
2. Glass or ceramic heat proof dishes-excellent for microwave cooking.
3. China dishes and plates-without metal trim may be used to cook and heat individual portions of food.
4. Wood or straw-use only for short period, wood contains some moisture and the microwave energy may cause the wood to dry out and crack.
5. Aluminum foil-may be used in very small pieces for shielding only.
Any aluminum foil used should never be closer than 2.5 cm from side walls of oven.
6. Plastic-most heat resistant plastic dinnerware may be used for heating food. However polyethylene, melamine, phenol are unsuitable for use in the oven. They become hot in the microwave.
7. Wax paper-use as a cover to avoid spatters.
8. Metal-In general, metal utensils should not be used in microwave oven.

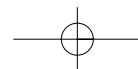

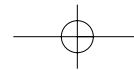

CARE AND CLEANING

Although your oven is provided with safety features, it is important to observe the following:

1. It is important not to defeat or tamper with safety interlocks.
2. Do not place any object between the oven front face and the door or allow residue to accumulate on sealing surfaces. Wipe the sealing area frequently with a mild detergent, rinse and wipe dry. Never use abrasive powders or pads.
3. When opened, the door must not be subjected to strain, for example, a child hanging on an opened door or any load could cause the oven to fall forward to cause injury and also damaged to the door. Do not operate the oven if it is damaged, until it has been repaired by a trained service technician.
It is particularly important that the oven closes properly and that there is no damage to the:
 - i) Door (bent)
 - ii) Hinges and Hooks (broken or loosened)
 - iii) Door seals and sealing surfaces.
4. The oven should not be adjusted or repaired by anyone except a properly trained service technician.

BEFORE YOU CALL FOR SERVICE

Refer to following checklist, you may prevent an unnecessary service call.

*** The oven doesn't work;**

1. Check that the power cord is securely plugged in.
2. Check that the door firmly closed.
3. Check that the cooking time is set.
4. Check for a blown circuit fuse or tripped main circuit breaker in your house.

*** Sparking in the cavity;**

1. Check that utensils are metal containers or dishes with metal trim.
2. Check that metal skewers do not touch the interior walls.

If there is still a problem, contact your dealer.

QUESTIONS AND ANSWERS

*** Q :** I accidentally ran my microwave oven without any food in it. Is it damaged?

A : Running the oven empty for a short time will not damage the oven. However, it is not recommended.

*** Q :** Can the oven be used with the glass tray or roller guide removed?

A : No. Both the glass tray and roller guide must always be used in the oven before cooking.

*** Q :** Can I open the door when the oven is operating?

A : The door can be opened anytime during the cooking operation. The microwave energy will be instantly switched off and the time setting will maintain until the door is closed.

*** Q :** Why do I have moisture in my microwave oven after cooking?

A : The moisture on the side of your microwave oven is normal. It is caused by steam from cooking food hitting the cool oven surface.

*** Q :** Does microwave energy pass through the viewing screen in the door?

A : No. The metal screen bounces back the energy to the oven cavity. The holes are made to allow light to pass through. They do not let microwave energy pass through.

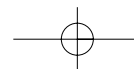

Free Manuals Download Website

<http://myh66.com>

<http://usermanuals.us>

<http://www.somanuals.com>

<http://www.4manuals.cc>

<http://www.manual-lib.com>

<http://www.404manual.com>

<http://www.luxmanual.com>

<http://aubethermostatmanual.com>

Golf course search by state

<http://golfingnear.com>

Email search by domain

<http://emailbydomain.com>

Auto manuals search

<http://auto.somanuals.com>

TV manuals search

<http://tv.somanuals.com>