

DAEWOO

MICROWAVE OVEN

KQG-868G7S

OPERATING INSTRUCTIONS
& COOK BOOK



Before operating this oven, please read these instructions completely.

PRECAUTIONS TO AVOID POSSIBLE EXPOSURE TO EXCESSIVE MICROWAVE ENERGY

- (a) **Do not attempt to operate this oven with the door** open since open-door operation can result in harmful exposure to microwave energy. It is important not to defeat or tamper with the safety interlocks.
- (b) **Do not place any object** between the oven front face and the door or allow soil or cleaner residue to accumulate on sealing surfaces.
- (c) **WARNING** : If the door or door seals are damaged, the oven must not be operated until it has been repaired by a competent person : (1) door (bent), (2) hinges and latches(broken or loosened), (3) door seals and sealing surfaces.
- (d) **WARNING** : It is hazardous for anyone other than a competent person to carry out any service or repair operation which involves the removal of a cover which gives protection against exposure to microwave energy.
- (e) **WARNING** : Liquids and other foods must not be heated in sealed containers since they are liable to explode.
- (f) **WARNING** : Only allow children to use the oven without supervision when adequate instructions have been given so that the child is able to use the oven in a safe way and understands the hazards of improper use.

TABLE OF CONTENTS

PRECAUTIONS TO AVOID POSSIBLE EXPOSURE TO EXCESSIVE MICROWAVE ENERGY.....	1
IMPORTANT SAFETY INSTRUCTIONS	2
EARTHING INSTRUCTIONS	3
INSTALLATION	3
FEATURES DIAGRAM.....	4~5
OPERATION PROCEDURE	6
HOW TO SET THE OVEN CONTROLS.....	7~20
CARE OF YOUR MICROWAVE OVEN	21
QUESTIONS AND ANSWERS	22
BEFORE YOU CALL FOR SERVICE	23
CARE AND CLEANING	23
SPECIFICATIONS.....	23
COOKING INSTRUCTIONS.....	24
USE YOUR MICROWAVE OVEN SAFELY.....	25
ARCING.....	25
MICROWAVING PRINCIPLES	26
HOW MICROWAVES COOK FOOD.....	26
CONVERSION CHARTS.....	26
COOKING TECHNIQUES	27
DEFROSTING GUIDE	28
DEFROSTING CHART	28
COOKING & REHEATING CHART.....	29~30
VEGETABLE CHART	31
RECIPES.....	32~34

IMPORTANT SAFETY INSTRUCTIONS

READ CAREFULLY AND KEEP FOR FUTURE REFERENCE

WARNING : To prevent fire, burns, electric shock and other warnings:

Listed below are, as with all appliances, certain rules to follow and safeguards to assure high performance from this oven:

1. Do not use the oven for any reason other than food preparation, such as for drying clothes, paper, or any other nonfood items or for sterilizing purposes.
2. Do not use the oven when empty, this could damage the oven.
3. Do not use the oven cavity for any type of storage, such as papers, cookbook, cookware, etc.
4. Do not operate the oven without the glass tray in place. Be sure it is properly sitting on the rotating base.
5. Make sure you remove caps or lids prior to cooking when you cook food sealed in bottles.
6. Do not put foreign material between the oven surface and door. It could result in excessive leakage of microwave energy.
7. Do not use recycled paper products for cooking. They may contain impurities which could cause sparks and/or fires when used during cooking.
8. Do not pop popcorn unless popped in a microwave approved popcorn popper or unless it's commercially packaged and recommended especially for microwave ovens. Microwave popped corn produces a lower yield than conventional popping; there will be a number of unpopped kernels. Do not use oil unless specified by the manufacturer.
9. Do not cook any food surrounded by a membrane, such as egg yolks, potatoes, chicken livers, etc., without first piercing them several times with a fork.
10. Do not pop popcorn longer than the manufacturer's directions. (popping time is generally below 3 minutes). Longer cooking does not yield more popped corn, it can cause scorchings and fire.
Also, the cooking tray can become too hot to handle or may break.
11. If smoke is observed, switch off or unplug the appliance and keep the door closed in order to stifle any flames.
12. When heating food in plastic or paper containers, keep an eye on the oven due to the possibility of ignition.
13. The contents of feeding bottles and baby food jars shall be stirred or shaken and the temperature checked before consumption, in order to avoid burns.
14. Always test the temperature of food or drink which has been heated in a microwave oven before you give it to somebody, especially to children or elderly people. This is important because things which have been heated in a microwave oven carry on getting hotter even though the microwave oven cooking has stopped.
15. Eggs in their shell and whole hard-boiled eggs should not be heated in microwave ovens since they may explode, even after microwave heating has ended;
16. Keep the waveguide cover clean at all times. Wipe the oven interior with a soft damp cloth after each use. If you leave grease or fat anywhere in the cavity it may overheat, smoke or even catch fire when next using the oven.
17. Never heat oil or fat for deep frying as you cannot control the temperature and doing so may lead to overheating and fire.
18. Liquids, such as water, coffee, or tea are able to be overheated beyond the boiling point without appearing to be boiling due to surface tension of the liquid. Visible bubbling or boiling when the container is removed from the microwave oven is not always present. **THIS COULD RESULT IN VERY HOT LIQUIDS SUDDENLY BOILING OVER WHEN A SPOON OR OTHER UTENSIL IS INSERTED INTO THE LIQUID.**
To reduce the risk of injury to persons:
 - a) Do not overheat the liquid.
 - b) Stir the liquid both before and halfway through heating it
 - c) Do not use straight-sided containers with narrow necks.
 - d) After heating, allow the container to stand in the microwave oven for a short time before removing the container.
 - e) Use extreme care when inserting a spoon or other utensil into the container.

SAVE THESE INSTRUCTIONS

EARTHING INSTRUCTIONS

This appliance must be earthed. In the event of an electrical short circuit, earthing reduces the risk of electric shock by providing an escape wire for the electric current. This appliance is equipped with a cord having a earthing wire with a earthing plug. The plug must be plugged into an outlet that is properly installed and earthed.

WARNING : Improper use of the earthing plug can result in a risk of electric shock. Consult a qualified electrician or serviceman if the earthing instructions are not completely understood, or if doubt exists as to whether the appliance is properly earthed. If it is necessary to use an extension cord, use only a 3-wire extension cord that has a 3-blade earthing plug, and a 3-slot receptacle that will accept the plug on the appliance. The marked rating of the extension cord should be equal to or greater than the electrical rating of the appliance.

IMPORTANT NOTE

The wires in this mains lead fitted to this appliance are coloured in accordance with the following code.

Green-and-yellow : Earth

Blue : Neutral

Brown : Live

As the colours of the wires in the mains lead of this appliance may not correspond with the coloured markings identifying the terminals in your plug, proceed as follows : the wire which is coloured green-and-yellow must be connected to the terminal in the plug which is marked with the letter 'E' or by the earth symbol or green-and-yellow. The wire which is coloured blue must be connected to the terminal which is marked with the letter 'N' or coloured black. The wire which is coloured brown must be connected to the terminal which is marked with the letter 'L' or coloured red.

WARNING : The appliance must be earthed.

INSTALLATION

1. Ventilation

Do not block air vents. If they are blocked during operation, the oven may overheat and eventually cause a failure. For proper ventilation, allow above 3 inches of space between oven sides, rear and the minimum height of free space necessary above the top surface of the oven is 100mm.

2. Steady, flat location

This oven should be set on a steady, flat surface. This oven is designed for counter top use only.

3. Leave space behind and side

All air vents should be kept a clearance. If all vents are covered during operation, the oven may overheat and, eventually, oven failure.

4. Away from radio and TV sets

Poor television reception and radio interference may result if the oven is located close to a TV, Radio antenna, feeder and so on. Position the oven as far from them as possible.

5. Away from heating appliance and water taps

Keep the oven away from hot air, steam or Splash when choosing a place to position it, or the insulation might be adversely affected and breakdowns occur.

6. Power supply

- Check your local power source. This oven requires a current of approximately 11 amperes, 230V 50Hz.
- Power supply cord is about 0.8 meters long.
- The voltage used must be the same as specified on this oven. Using a higher voltage may result in a fire or other accident causing oven damage. Using low voltage will cause slow cooking. We are not responsible for damage resulting from use of this oven with a voltage of ampere fuse other than those specified.
- If the supply cord is damaged, it must be replaced by the manufacturer or its service agent or a similarly qualified person in order to avoid a hazard.

7. Examine the oven after unpacking for any damage such as:

A misaligned door, Broken door, A dent in cavity. If any of the above are visible, DO NOT INSTALL, and notify dealer immediately.

8. Do not operate the oven if it is colder than room temperature.

(This may occur during delivery in cold weather.) Allow the oven to become room temperature before operating.

FEATURES DIAGRAM

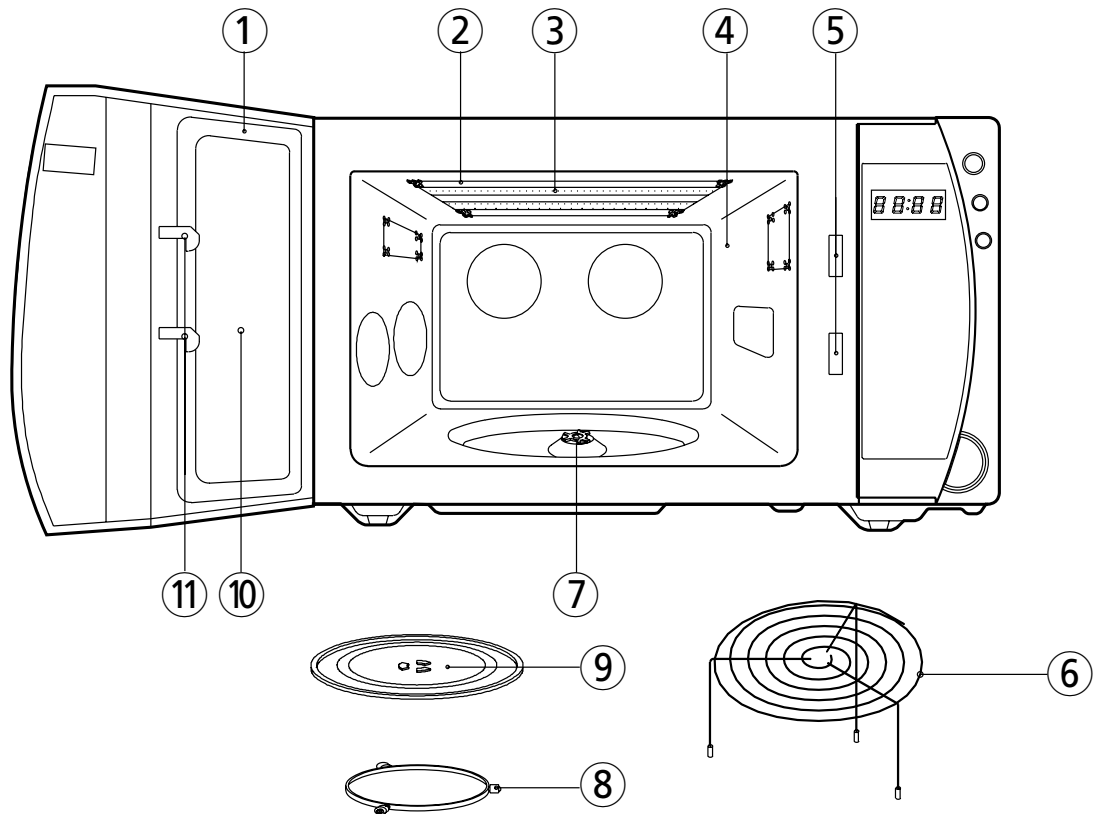

- ① **Door seal** - Door seal maintains the microwave energy within the oven cavity and prevents microwave leakage.
- ② **Cover Heater**
- ③ **Heating Element**
- ④ **Oven cavity**
- ⑤ **Safety interlock system**
- ⑥ **Metal Rack**
- ⑦ **Coupler** - This fits over the shaft in the center of the ovens cavity floor. This is to remain in the oven for all cooking.
- ⑧ **Roller guide** - This must always be used for cooking together with the glass cooking tray.
- ⑨ **Glass cooking tray** - Made of special heat resistant glass. Food in a proper receptacle is placed on this tray for cooking.
- ⑩ **Door viewing screen** - Allows viewing of food. The screen is designed so that light can pass through, but not the microwave.
- ⑪ **Door hook** - When the door is closed, it will automatically shut off. If the door is opened while the oven is operating, the magnetron will immediately stop operating.

FEATURES DIAGRAM (continued)

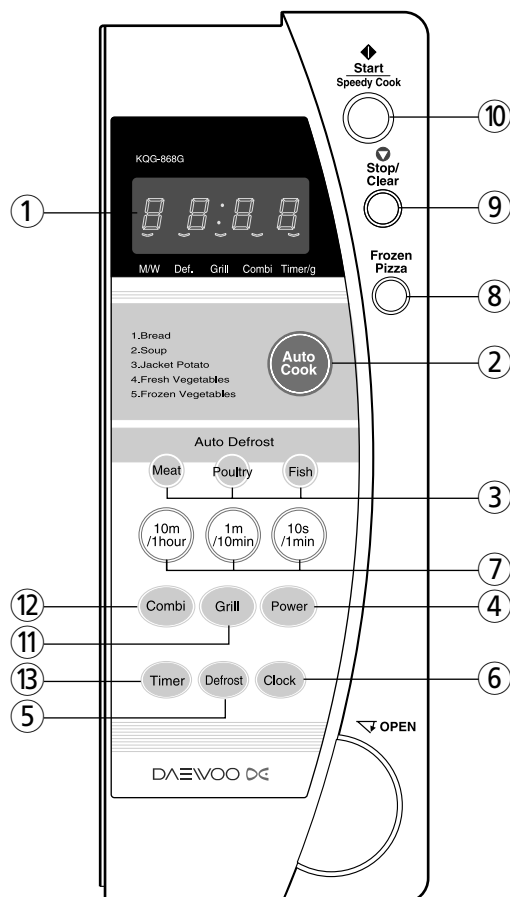

- ① **Display** - Cooking time, power level, present time are displayed.
- ② **Auto Cook** - Used to cook using a program or to reheat.
- ③ **Auto defrost** - Used to defrost foods.(for weight)
- ④ **Power** - Used to set power level.
- ⑤ **Defrost** - Used to defrost food.(for time)
- ⑥ **Clock** - Used to set clock.
- ⑦ **Time set pad** - Used to set the cooking time and the present time.
- ⑧ **Frozen Pizza** - Used to reheat frozen pizza.
- ⑨ **Stop/Clear**
Used to stop the oven operation or to delete the cooking data.
- ⑩ **Start/Speedy Cook** - Used to start the oven operation and also increase the reheat time by 30 seconds.
- ⑪ **Grill** - Used to cook grill.
- ⑫ **Combi** - Used to cook combi.
- ⑬ **Timer** - Used to set the delay time and holding time.

OPERATION PROCEDURE

This section includes useful information about oven operation.

1. Plug power supply cord into a standard 3- pronged 15 Amp, 230V AC 50Hz power outlet.
 2. After placing the food in a suitable container, open the oven door and put it on the glass tray.
The glass tray and roller guide must always be in place during cooking.
 3. Shut the door. Make sure that it is firmly closed.
- 1 The oven light is on only when the microwave oven is operating.
 - 2 The oven door can be opened at any time during operation by touching the door release button on the control panel. The oven will automatically shut off.
 - 3 Each time a pad is touched, a BEEP will sound to acknowledge the touch.
 - 4 The oven automatically cooks on full power unless set to a lower power level.
 - 5 The display will show ":0" when the oven is plugged in.
 - 6 Time clock returns to the present time when the cooking time ends.
 - 7 When the STOP/CLEAR button is pressed during the oven operation, the oven stops cooking and all information retained. To erase all information (except the present time), touch the STOP/CLEAR button once more. If the oven door is opened during the oven operation, all information is retained.
 - 8 If the START/SPEEDY COOK button is pressed and the oven does not operate, check the area between the door and door seal for obstructions and make sure the door is closed securely. The oven will not start cooking until the door is completely closed or the program has been reset.

Make sure the oven is properly installed and plugged into the electrical outlet.

WATTAGE OUTPUT CHART

- The power-level is set by pressing the POWER pad. The chart shows the display, the power level and the percentage of power.

Touch POWER pad, Once the Touch	Power Level (Display)	Approximate Percentage of Power
Once	P-HI	100%
Twice	P-90	90%
3 Times	P-80	80%
4 Times	P-70	70%
5 Times	P-60	60%
6 Times	P-50	50%
7 Times	P-40	40%
8 Times	P-30	30%
9 Times	P-20	20%
10 Times	P-10	10%
11 Times	P-00	0%

HOW TO SET THE OVEN CONTROLS

SETTING THE CLOCK

When the oven is first plugged in, the display will flash ":0" and a tone will sound. If the AC power ever goes off, the display shows ":0" when the power comes back on.

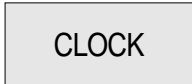
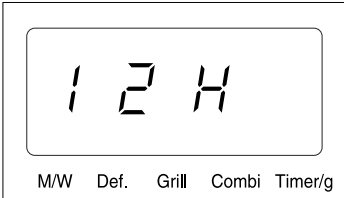
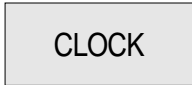
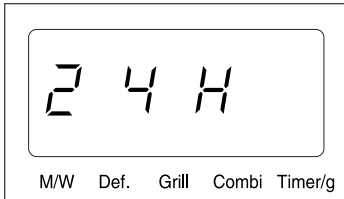
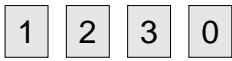
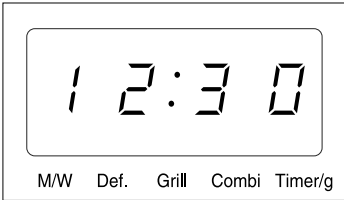
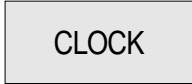
DO THIS...	THIS HAPPENS...
 1. Touch CLOCK pad.	 M/W Def. Grill Combi Timer/g This is a 12 hour clock system.
 2. Touch CLOCK pad once more.	 M/W Def. Grill Combi Timer/g This is a 24 hour clock system. NOTE: This oven is multiple clock system. If you want a 12 hour clock system, can be omitted this step.
 3. Enter the correct time of day by touching the numbers in sequence.	 M/W Def. Grill Combi Timer/g The display will then begin blinking.
 4. Touch CLOCK pad.	The display stop blinking and the colon starts blinking. If you selected 12 hour clock system this digital clock allows you to set from 1:00 to 12:59. If you selected 24 hour clock system, this digital clock allows you to set from 0:00 to 23:59.
NOTE: If you attempt to enter an incorrect time, the time will not be set and a error signal tone will sound. Touch the CLOCK pad re-enter the time.	

WEIGHT DEFROSTING

WEIGHT DEFROST lets you easily defrost food by eliminating guesswork in determining defrosting time. Follow the steps below for easy defrosting.

DO THIS...

THIS HAPPENS...



1. Touch **AUTO DEFROST** (MEAT/POULTRY/FISH) pad. ex) MEAT



The g indicator lights and defrosting weight is displayed.



2. Touch MEAT pads for the defrosting weight you want.
ex) MEAT touched twice.



The display will show defrost weight you pressed in the order you touched.



3. Press **START/SPEEDY COOK** button.

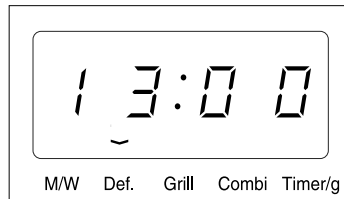

WEIGHT DEFROSTING begins. The defrosting time is automatically determined by the food category and weight entered. The g indicator goes off and the Def. indicator blinks and the defrosting time counts down in the display window. The oven beeps during the defrosting cycle to signal that the food needs to be turned or rearranged. When the defrosting time ends, you will hear 3 beeps.

NOTE: To prevent overdefrosting thin areas or edges can be shielded with strips of aluminum foil.

* WEIGHT DEFROST CHART

Touch pad	MEAT	POULTRY	FISH
once	500 g	800 g	300 g
twice	800 g	1000 g	500 g
3 times	1000 g	1200 g	800 g
4 times	1200 g	1500 g	1000 g

TIME DEFROSTING

When TIME DEFROST is selected, the automatic cycle divides the defrosting time into periods of alternating defrost and stand times by cycling on and off.

DO THIS...

THIS HAPPENS...

DEFROST

1. Touch **DEFROST** pad.

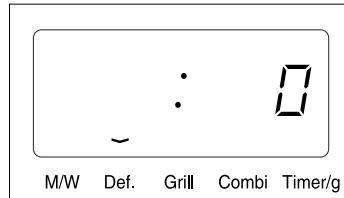

The Def. indicator lights and " :0" is displayed.

2 7 1 0

2. Touch number pads for the defrosting time you want.



The display will show the numbers you pressed in the order you touched.

NOTE: Your oven can be programmed for 59 minutes 90 seconds. (59:90)

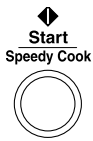

3. Press **START/SPEEDY COOK** button.

When you touch **START/SPEEDY COOK** button, the Def. indicator starts blinking to show the oven is in the TIME DEFROST mode. The display counts down the time to show you how much defrosting time is left in the TIME DEFROST mode. The oven beeps during the defrosting cycle to signal that the food needs to be turned or rearranged. When the defrosting time ends, you will hear 3 beeps.

NOTE: To prevent overdefrosting, thin areas or edges can be shielded with strips of aluminum foil.

COOKING IN ONE STAGE

DO THIS...



1. Touch **POWER** pad.

THIS HAPPENS...

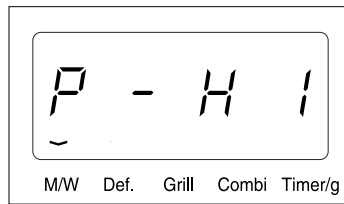

The STAGE 1 indicator lights and "P-HI " is displayed.



2. Touch **POWER** pad for the power level you want.

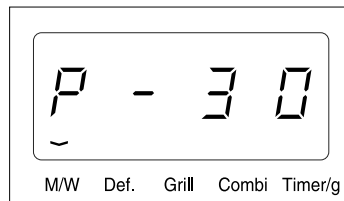

The display will show what you touched. This example shows power level 3.

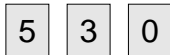

3. Touch number pads for the cooking time.



The display will show the numbers you pressed in the order you touched.

NOTE: Your oven can be programmed for 59 minutes 90 seconds. (59:90)



4. Touch **START/SPEEDY COOK** button.

When you press **START/SPEEDY COOK** button, the M/W indicator starts blinking to show the oven is cooking. The display counts down the time to show how much cooking time is left. When the cooking time ends, you will hear 3 beeps.

NOTE: Using lower power levels increase the cooking time which is recommended for foods such as cheese, milk and slow cooking of meats.

WEIGHT DEFROSTING AND COOKING IN ONE STAGE

Some recipes require frozen foods to be thawed before cooking.
This oven can be programmed to automatically defrost foods before cooking.

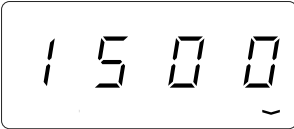
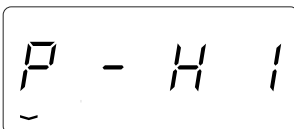
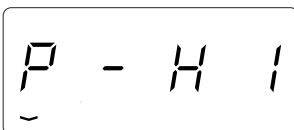
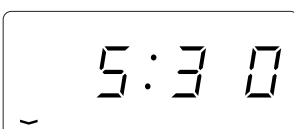
DO THIS...	THIS HAPPENS...	
<div data-bbox="240 450 432 533" style="border: 1px solid black; padding: 5px; text-align: center; margin-bottom: 10px;">POULTRY</div> 1. Touch AUTO DEFROST (MEAT/POULTRY/FISH) pad. ex) POULTRY	 <p style="text-align: center; font-size: small;">M/W Def. Grill Combi Timer/g</p>	The Def. indicator lights and "800" is displayed.
<div data-bbox="240 741 432 824" style="border: 1px solid black; padding: 5px; text-align: center; margin-bottom: 10px;">POULTRY</div> 2. Touch POULTRY pads for the defrosting weight you want. ex) The pad pressed 4times.	 <p style="text-align: center; font-size: small;">M/W Def. Grill Combi Timer/g</p>	The display will show the defrost weight you pressed in the order you touched.
<div data-bbox="240 1021 432 1104" style="border: 1px solid black; padding: 5px; text-align: center; margin-bottom: 10px;">POWER</div> 3. Touch POWER pad.	 <p style="text-align: center; font-size: small;">M/W Def. Grill Combi Timer/g</p>	The M/W indicator lights and "P-HI " is displayed.
<div data-bbox="240 1279 432 1361" style="border: 1px solid black; padding: 5px; text-align: center; margin-bottom: 10px;">POWER</div> 4. Touch POWER pad for the power level you want.	 <p style="text-align: center; font-size: small;">M/W Def. Grill Combi Timer/g</p>	This example shows full power (100%).
<div style="display: flex; justify-content: space-around; margin-bottom: 10px;"> <div style="border: 1px solid black; padding: 2px 5px;">5</div> <div style="border: 1px solid black; padding: 2px 5px;">3</div> <div style="border: 1px solid black; padding: 2px 5px;">0</div> </div> 5. Touch number pads for the cooking time you want in the first stage.	 <p style="text-align: center; font-size: small;">M/W Def. Grill Combi Timer/g</p>	The display will show the numbers you pressed in the order you touched. This example shows 5 minutes 30 seconds at full power.

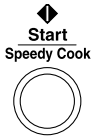
DO THIS...

6. Press **START/SPEEDY COOK** button.

THIS HAPPENS...

When you press START/SPEEDY COOK button, the Def. and M/W indicators lights. The Def. indicator starts blinking to show you that the oven is in Def. mode. The display counts down the time remaining in WEIGHT DEFROST mode. Turn over, break a part and redistribute at a beep.

At the end of WEIGHT DEFROST mode, the oven will beep and start stage one. The Def. indicator goes off and the M/W indicator starts blinking. The display counts down the time remaining in stage, you will hears 3 beeps.

TIME DEFROSTING AND COOKING IN ONE STAGE

Some recipes require frozen foods to be thawed before cooking.
This oven can be programmed to automatically defrost foods before cooking.

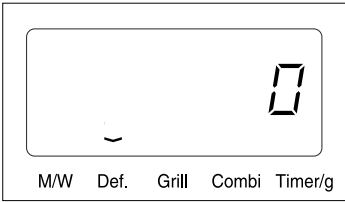
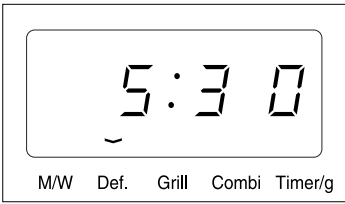
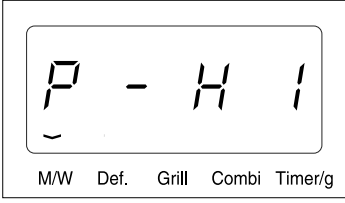
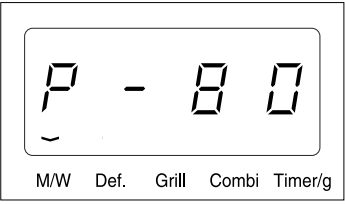
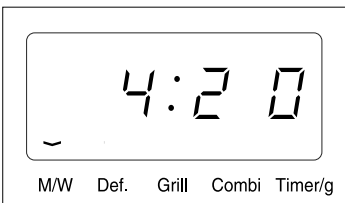
DO THIS...	THIS HAPPENS...	
<div data-bbox="240 450 432 533" style="border: 1px solid black; padding: 5px; text-align: center; margin-bottom: 10px;">DEFROST</div> 1. Touch DEFROST pad.	 <p>The display shows '0' and the Def. indicator light is lit. Below the display are labels: M/W, Def., Grill, Combi, Timer/g.</p>	The Def. indicator lights and " : 0" is displayed.
<div data-bbox="240 707 408 763" style="display: flex; justify-content: space-around; border: 1px solid black; padding: 5px;"> 5 3 0 </div> 2. Touch number pads for the cooking time you want in the first stage.	 <p>The display shows '5:30' and the Def. indicator light is lit. Below the display are labels: M/W, Def., Grill, Combi, Timer/g.</p>	The display will show the numbers you pressed in the order you touched. This example shows 5 minutes 30 seconds.
<div data-bbox="240 969 432 1052" style="border: 1px solid black; padding: 5px; text-align: center; margin-bottom: 10px;">POWER</div> 3. Touch POWER pad.	 <p>The display shows 'P-HI' and the M/W indicator light is lit. Below the display are labels: M/W, Def., Grill, Combi, Timer/g.</p>	The M/W indicator lights and "P-HI" is displayed.
<div data-bbox="240 1227 432 1310" style="border: 1px solid black; padding: 5px; text-align: center; margin-bottom: 10px;">POWER</div> 4. Touch the POWER pads for the power level you want.	 <p>The display shows 'P-80' and the M/W indicator light is lit. Below the display are labels: M/W, Def., Grill, Combi, Timer/g.</p>	The display will show what you touched.
<div data-bbox="240 1480 408 1536" style="display: flex; justify-content: space-around; border: 1px solid black; padding: 5px;"> 4 2 0 </div> 5. Touch the number pads for the cooking time you want.	 <p>The display shows '4:20' and the M/W indicator light is lit. Below the display are labels: M/W, Def., Grill, Combi, Timer/g.</p>	The display will show the numbers you pressed in the order you touched. This example shows 4 minutes 20 seconds at power level 8.

DO THIS...

THIS HAPPENS...

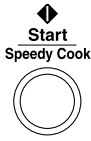

6. Press **START/SPEEDY COOK** button.

When you press START/SPEEDY COOK button, the Def. and M/W indicators lights. The Def. indicator starts blinking to show you that the oven is in Def. mode. The display counts down the time remaining in TIME DEFROST mode. Turn over, break a part and redistribute at a beep.

At the end of TIME DEFROST mode, the oven will beep and start stage one. The Def. indicator goes off and the M/W indicator starts blinking. The display counts down the time remaining in stage, you will hears 3 beeps.

SPEEDY COOK

SPEEDY COOK allows you to reheat for 30 seconds at 100% (full power) by simply pressing the START/SPEEDY COOK button.

By repeatedly pressing the START/SPEEDY COOK button, you can also extend reheating time to 5 minutes by 30 seconds.

DO THIS...

THIS HAPPENS...

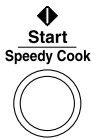

1. Press **START/SPEEDY COOK** button.

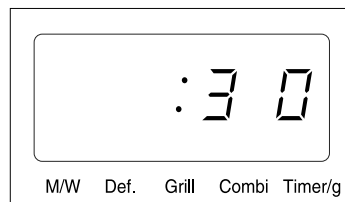

When you press START/SPEEDY COOK button, ":30" is displayed. After 1.5 seconds, the oven starts reheating.

AUTO COOKING

Auto Cook allows you to cook or reheat many of your favorite foods by touching just one pad. To increase quantity, touch chosen pad until number in display is same as desired quantity to cook.

DO THIS...

THIS HAPPENS...

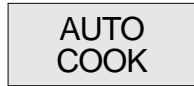

1. Touch **AUTO COOK** pad.

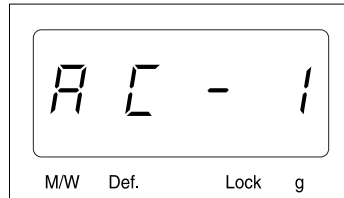

When you touch AUTO COOK pad, "AC-1" is displayed.

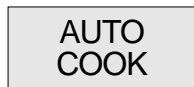

2. Touch **AUTO COOK** pad for menu you want. (Refer to AUTO COOK chart below)

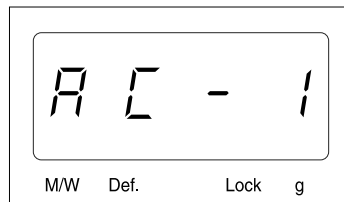

This display show cook menu you pressed in the order you touched.

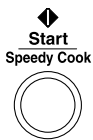

3. Press **START/SPEEDY COOK** button.
ex) 1. Bread

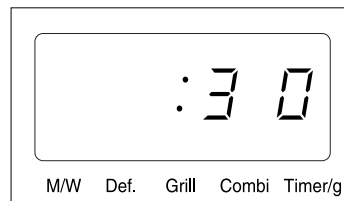

When you press START/SPEEDY COOK button " : 30" is displayed, the display counts down the time. It is automatically determined by food category.

* AUTO COOK CHART

Touch pad	Auto Cook menu	Display	Cooking time
once	1. Bread	AC-1	: 30
twice	2. Soup	AC-2	2 : 20
3 twice	3. Jacket Potato	AC-3	11 : 00
4 times	4. Fresh Vegetables	AC-4	2 : 20
5 times	5. Frozen Vegetables	AC-5	2 : 20

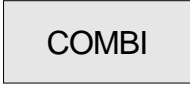
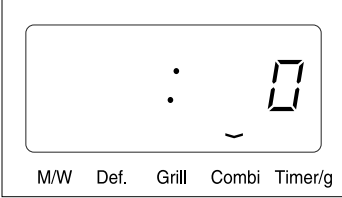
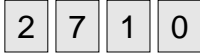
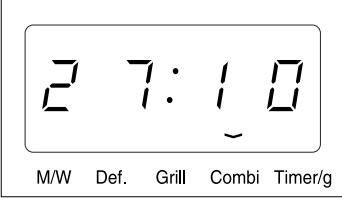
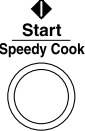

COMBI COOKING

The oven has combination mode which cooks food with heater and microwave at the same time.

DO THIS...	THIS HAPPENS...
 1. Touch COMBI pad.	 The Combi. indicator lights and " :0" is displayed.
 2. Touch number pads for the combi time you want.	 The display will show the numbers you pressed in the order you touched. NOTE: Your oven can be programmed for 59 minutes 90 seconds. (59:90)
 3. Press START/SPEEDY COOK button.	When you touch START/SPEEDY COOK button, the Combi. indicator starts blinking to show the oven is in the cooking mode. The display counts down the time to show you how much cooking time is left. When the cooking time ends, you will hear 3 beeps.

GRILL COOKING

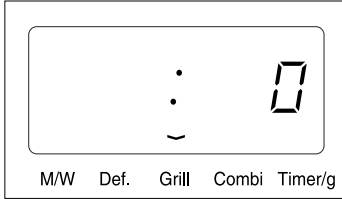
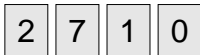
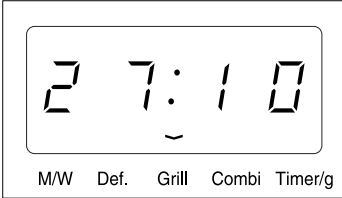
The function allow you to brown food quickly. The heating element is located in the top of the oven.

DO THIS...	THIS HAPPENS...
 1. Touch GRILL pad.	 The Grill indicator lights and " :0" is displayed.
 2. Touch number pads for the defrosting time you want.	 The display will show the numbers you pressed in the order you touched. NOTE: Your oven can be programmed for 29 minutes 90 seconds. (29:90)
 3. Press START/SPEEDY COOK button.	When you touch START/SPEEDY COOK button, the Grill indicator starts blinking to show the oven is in the cooking mode. The display counts down the time to show you how much cooking time is left. When the cooking time ends, you will hear 3 beeps.

TIMER MODE

Timer operates as a minute timer and without microwave energy.

DO THIS...

THIS HAPPENS...



1. Touch **TIMER** pad.

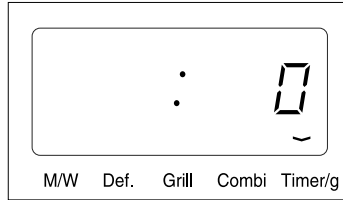

The Timer indicator lights and " :0" is displayed.

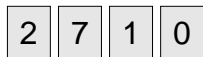

2. Touch number pads for the Timer time you want.

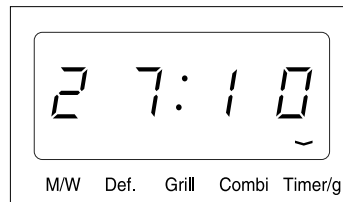

The display will show the numbers you pressed in the order you touched.

NOTE: Your oven can be programmed for 59 minutes 90 seconds. (59:90)

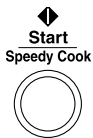



3. Press **START/SPEEDY COOK** button.

When you touch **START/SPEEDY COOK** button, the Timer indicator starts blinking to show the oven is in the **TIMER** mode. When the setting time ends, you will hear 3 beeps.

TIMER SETTING FOR THE DELAY START

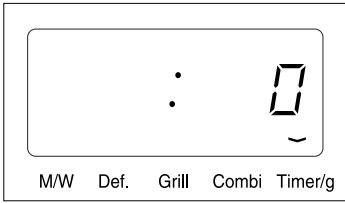
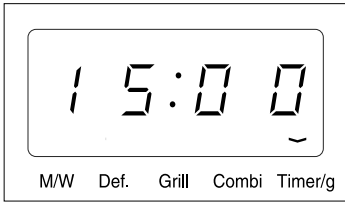
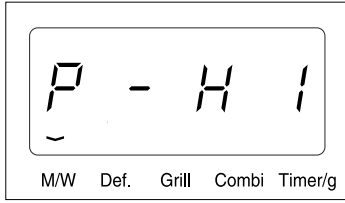
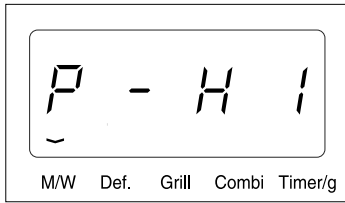
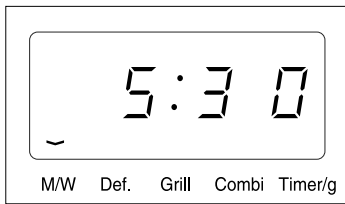
In order to set the delay start time, follow the steps belowed.

DO THIS...	THIS HAPPENS...
<p>TIMER</p> <p>1. Touch TIMER pad.</p>	 <p>The Timer indicator lights and " : 0" is displayed.</p>
<p>1 5 0 0</p> <p>2. Touch number pads for the setting time you want.</p>	 <p>The display will show the setting time you pressed in the order you touched.</p>
<p>POWER</p> <p>3. Touch POWER pad.</p>	 <p>The M/W indicator lights and "P-HI" is displayed.</p>
<p>POWER</p> <p>4. Touch POWER pad for the power level you want.</p>	 <p>This example shows full power (100%).</p>
<p>5 3 0</p> <p>5. Touch number pads for the cooking time you want in the first stage.</p>	 <p>The display will show the numbers you pressed in the order you touched. This example shows 5 minutes 30 seconds at full power.</p>
 <p>6. Press START/SPEEDY COOK button.</p>	<p>When you press START/SPEEDY COOK button, the timer and M/W indicators lights. The timer indicator starts blinking to show you that the oven is in timer mode. The display counts down the time remaining in timer mode.</p> <p>At the end of the timer mode, the oven will beep and start the M/W mode. The timer indicator goes off and the M/W indicator starts blinking. The display counts down the time remaining in stage, you will hears 3 beeps.</p>

TIMER SETTING FOR THE HOLDING TIME

In order to set the holding time, follow the steps belowed.

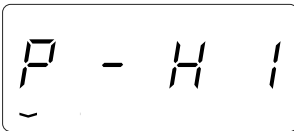
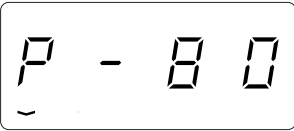
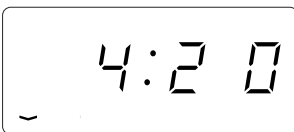
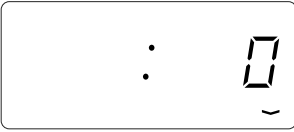
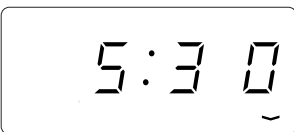
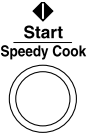
DO THIS...	THIS HAPPENS...	
<div data-bbox="240 398 432 483" style="border: 1px solid black; padding: 5px; text-align: center; margin-bottom: 5px;">POWER</div> 1. Touch POWER pad.	<div data-bbox="560 398 903 595" style="border: 1px solid black; padding: 5px; text-align: center;">  <p style="font-size: small; margin-top: 5px;">M/W Def. Grill Combi Timer/g</p> </div>	The M/W indicator lights and "P-HI" is displayed.
<div data-bbox="240 663 432 748" style="border: 1px solid black; padding: 5px; text-align: center; margin-bottom: 5px;">POWER</div> 2. Touch the POWER pads for the power level you want.	<div data-bbox="560 663 903 860" style="border: 1px solid black; padding: 5px; text-align: center;">  <p style="font-size: small; margin-top: 5px;">M/W Def. Grill Combi Timer/g</p> </div>	The display will show what you touched. This example shows 80% power.
<div data-bbox="240 913 408 965" style="display: flex; justify-content: space-around; margin-bottom: 5px;"> 4 2 0 </div> 3. Touch the number pads for the cooking time you want.	<div data-bbox="560 913 903 1111" style="border: 1px solid black; padding: 5px; text-align: center;">  <p style="font-size: small; margin-top: 5px;">M/W Def. Grill Combi Timer/g</p> </div>	The display will show the numbers you pressed in the order you touched. This example shows 4 minutes 20 seconds at power level 8.
<div data-bbox="240 1178 432 1263" style="border: 1px solid black; padding: 5px; text-align: center; margin-bottom: 5px;">TIMER</div> 4. Touch TIMER pad.	<div data-bbox="560 1178 903 1375" style="border: 1px solid black; padding: 5px; text-align: center;">  <p style="font-size: small; margin-top: 5px;">M/W Def. Grill Combi Timer/g</p> </div>	The Timer indicator lights and " : 0" is displayed.
<div data-bbox="240 1429 408 1480" style="display: flex; justify-content: space-around; margin-bottom: 5px;"> 5 3 0 </div> 5. Touch number pads for the holding time you want in the first stage.	<div data-bbox="560 1429 903 1626" style="border: 1px solid black; padding: 5px; text-align: center;">  <p style="font-size: small; margin-top: 5px;">M/W Def. Grill Combi Timer/g</p> </div>	The display will show the numbers you pressed in the order you touched. This example shows 5 minutes 30 seconds.
<div data-bbox="296 1671 384 1805" style="text-align: center; margin-bottom: 5px;">  </div> 6. Press START/SPEEDY COOK button.	<p>When you press START/SPEEDY COOK button, the timer and M/W indicators lights. The M/W. indicator starts blinking to show you that the oven is in M/W mode. The display counts down the time remaining in M/W mode. At the end of M/W mode, the oven will beep. The M/W indicator goes off and the timer indicator starts blinking. The display counts down the time remaining in stage, you will hears 3 beeps.</p>	

ONE TOUCH COOKING

DO THIS...



1. Press **FROZEN PIZZA** button.

THIS HAPPENS...



When you press Frozen Pizza button, "200" is displayed. The g indicator lights. After the 1.5 seconds, the display changed into cooking time of quantity and the oven starts cooking. The g indicator goes off.

* Frozen Pizza *

- 200g: Press Frozen Pizza once.
- 400g: Press Frozen Pizza twice within 1.5 seconds.

CHILD SAFETY LOCK

The safety lock prevents unwanted oven operation such as by small children.

To set, Press STOP/CLEAR for 3 seconds, and then the oven will beep and lock function activated.

To cancel, press STOP/CLEAR for 3 seconds, and then the oven will beep and lock function canceled.

TO STOP THE OVEN WHILE THE OVEN IS OPERATING

1. Press STOP/CLEAR button.
 - You can restart the oven by pressing START/SPEEDY COOK button.
 - Press STOP/CLEAR once more to erase all instructions.
 - You must enter in new instructions.
2. Open the door.
 - You can restart the oven by closing the door and pressing START/SPEEDY COOK button.

NOTE: Oven stops operating when door is opened.

CARE OF YOUR MICROWAVE OVEN

- 1 Turn the oven off before cleaning.
- 2 Keep the inside of the oven clean. When food spatters or spilled liquids adhere to oven walls, wipe with a damp cloth. Mild detergent may be used if the oven gets very dirty. The use of harsh detergent or abrasives is not recommended.
- 3 The outside oven surface should be cleaned with soap and water, rinsed and dried with a soft cloth. To prevent damage to the operating parts inside the oven, water should not be allowed to seep into the ventilation openings.
- 4 If the Control Panel becomes wet, clean with a soft, dry cloth. Do not use harsh detergents or abrasives on Control Panel.
- 5 If steam accumulates inside or around the outside of the oven door, wipe with a soft cloth. This may occur when the microwave oven is operated under high humidity conditions and in no way indicates malfunction of the unit.
- 6 It is occasionally necessary to remove the glass tray for cleaning. Wash the tray in warm sudsy water or in a dishwasher.
- 7 The roller guide and oven cavity floor should be cleaned regularly to avoid excessive noise. Simply wipe the bottom surface of the oven with mild detergent water or window cleaner and dry. The roller guide may be washed in mild sudsy water.

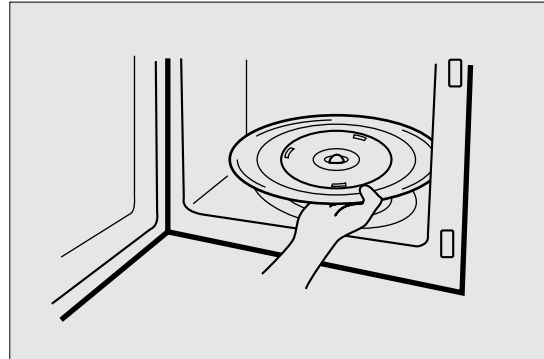

ROLLER GUIDE

- 1 The ROLLER GUIDE and oven floor should be cleaned frequently to prevent excessive noise.
- 2 The ROLLER GUIDE MUST ALWAYS be used for cooking together with the Glass Tray.

GLASS TRAY

- 1 DO NOT operate the oven without the Glass Tray in place.
- 2 DO NOT use any other Glass Tray with this oven.
- 3 If Glass Tray is hot, ALLOW TO COOL before cleaning or placing it in water.
- 4 DO NOT cook directly on the Glass Tray. (Except for popcorn)

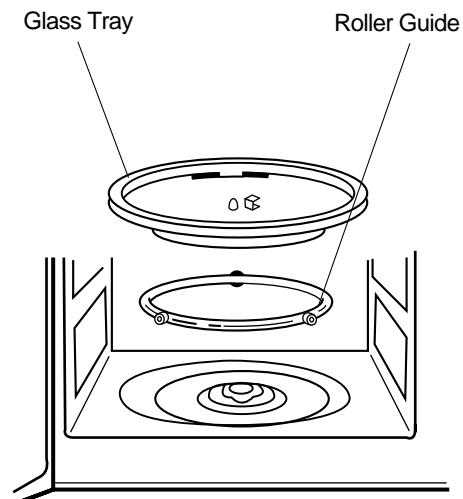

QUESTIONS AND ANSWERS

*** Q : I accidentally ran my microwave oven without any food in it. Is it damaged?**

A : Running the oven empty for a short time will not damage the oven. However, it is not recommended.

*** Q : Can the oven be used with the glass tray or roller guide removed?**

A : No. Both the glass tray and roller guide must always be used in the oven before cooking.

*** Q : Can I open the door when the oven is operating?**

A : The door can be opened anytime during the cooking operation. Then microwave energy will be instantly switched off and the time setting will maintain until the door is closed.

*** Q : Why do I have moisture in my microwave oven after cooking?**

A : The moisture on the side of your microwave oven is normal. It is caused by steam from cooking food hitting the cool oven surface.

*** Q : Does microwave energy pass through the viewing screen in the door?**

A : No. The metal screen bounces back the energy to the oven cavity. The holes are made to allow light to pass through. They do not let microwave energy pass through.

*** Q : Why do eggs sometimes pop?**

A : When baking or poaching eggs, the yolk may pop due to steam build-up inside the yolk membrane. To prevent this, simply pierce the yolk with a toothpick before cooking. Never cook eggs without piercing their shells.

*** Q : Why this standing time recommended after the cooking operation has been completed?**

A : Standing time is very important. With microwave cooking, the heat is in the food, not in the oven. Many foods build up enough internal heat to allow the cooking process to continue, even after the food is removed from the oven. Standing time for joints of meat, large vegetables and cakes is to allow the inside to cook completely, without overcooking the outside.

*** Q : What does "standing time" mean?**

A : "Standing time" means that food should be removed from the oven and covered for additional time to allow it to finish cooking. This frees the oven for other cooking.

*** Q : Why does my oven not always cook as fast as the microwave cooking guide says?**

A : Check your cooking guide again, to make sure you've followed directions exactly ; and to see what might cause variations in cooking time. Cooking guide times and heat settings are suggestions, to help prevent over-cooking... the most common problem in getting used to a microwave oven.

Variations in the size, shape and weights and dimensions could require longer cooking time. Use your own judgement along with the cooking guide suggestions to check whether the food has been properly cooked just as you would do with a conventional cooker.

*** Q : Will the microwave oven be damaged if it operates while empty?**

A : Yes. Never run it empty.

*** Q : Can I operate my microwave oven without the turntable or turn the turntable over to hold a large dish?**

A : No. If you remove or turn over the turntable, you will get poor cooking results. Dishes used in your oven must fit on the turntable.

*** Q : Is it normal for the turntable to turn in either direction?**

A : Yes. The turntable rotates clockwise or counterclockwise, depending on the rotation of the motor when the cooking cycle begins.

*** Q : Can I pop popcorn in my microwave oven? How do I get the best results?**

A : Yes. Pop packaged microwave popcorn following manufacture's guidelines. Do not use regular paper bags. Use the "listening test" by stopping the oven as soon as the popping slows to a "pop" every 1 or 2 seconds. Do not repop unpopped kernels. Do not pop popcorn in glass cookware.

BEFORE YOU CALL FOR SERVICE

Refer to following checklist, you may prevent an unnecessary service call.

*** The oven doesn't work :**

1. Check that the power cord is securely plugged in.
2. Check that the door is firmly closed.
3. Check that the cooking time is set.
4. Check for a blown circuit fuse or tripped main circuit breaker in your house.

*** Sparking in the cavity;**

1. Check utensils. Metal containers or dishes with metal trim should not be used.
2. Check that metal skewers or foil does not touch the interior walls.

If there is still a problem, contact the service station. A list of these stations is included in the oven.

DO NOT ATTEMPT TO SERVICE THE OVEN YOURSELF !

CARE AND CLEANING

Although your oven is provided with safety features, it is important to observe the following:

1. It is important not to defeat or tamper with safety interlocks.
2. Do not place any object between the oven front face and the door or allow residue to accumulate on sealing surfaces. Wipe the sealing area frequently with a mild detergent, rinse and dry. Never use abrasive powders or pads.
3. When opened, the door must not be subjected to strain, for example, a child hanging on an opened door or any load could cause the oven to fall forward to cause injury and also damage to the door. Do not operate the oven if it is damaged, until it has been repaired by a competent service technician. It is particularly important that the oven closes properly and that there is no damage to the:
 - i) Door(bent)
 - ii) Hinges and Hookes(broken or loosened)
 - iii) Door seals and sealing surfaces.
4. The oven should not be adjusted or repaired by anyone except a properly competent service technician.
5. The oven should be cleaned regularly and any food deposits removed;
6. Failure to maintain the oven in a clean condition could lead to deterioration of the surface that could adversely affect the life of the appliance and possibly result in a hazardous situation.

SPECIFICATIONS

POWER SUPPLY		230V 50Hz 12A, SINGLE PHASE WITH EARTHING
POWER CONSUMPTION	MICROWAVE	1350 W
	GRILL	1050 W
	COMBINATION	2350 W
MICROWAVE ENERGY OUTPUT		900 W
MICROWAVE FREQUENCY		2450MHz
OUTSIDE DIMENSIONS (W X H X D)		495 X 294 X 394mm
CAVITY DIMENSIONS (W X H X D)		320 X 237 X 343mm(12.6 X 9.3 X 13.5 in)
NET WEIGHT		APPROX. 14Kg (31 lbs)
TIMER		59 min. 90 sec.
POWER SELECTIONS		10 LEVELS

* Specifications are subject to change without notice.

COOKING INSTRUCTIONS

Utensil Guide

Only use utensils that are suitable for use in microwave ovens.

To cook food in the microwave oven, the microwaves must be able to penetrate the food, without being reflected or absorbed by the dish used. Care must therefore be taken choosing the utensil. If the utensil is marked microwave-safe, you do not need to worry. The following table lists various of utensil and indicates whether and how they should be used in a microwave oven.

Utensil	Safe	Comments
Aluminium foil	▲	Can be used in small quantities to protect areas against overcooking. Arcing can occur if the foil is too close to the oven wall or if too much foil is used.
Crust plate	●	Do not preheat for more than 8minutes.
China and earthenware	●	Porcelain, pottery, glazed earthenware and bone china are usually suitable, unless deco-rated with a metal trim.
Disposable polyester cardboard dishes	●	Some frozen foods are packaged in these dishes.
Fast-food packaging • Polystyrene cups containers • Paper bags or newspaper • Recycled paper or metal trims	● X X	Can be used to warm food. Overheating may cause the polystyrene to melt. May catch fire. May cause arcing.
Glassware • Oven-to-table ware • Fine glassware • Glass jars	● ● ●	Can be used, unless decorated with a metal trim. Can be used to warm foods or liquids. Delicate glass may break or crack if heated suddenly. Must remove the lid. Suitable for warming only.
Metal • Dishes • Freezer bag twist ties	X X	May cause arcing or fire.
Paper • Plates, cups, napkins and Kitchen paper • Recycled paper	● X	For short cooking times and warming. Also to absorb excess moisture. May cause arcing.
Plastic • Containers • Cling film • Freezer bags	● ● ▲	Particularly if heat-resistant thermoplastic. Some other plastics may warp or discolour at high temperatures. Do not use Melamine plastic. Can be used to retain moisture. Should not touch the food. Take care when removing the film as hot steam will escape. Only if boilable or oven-proof. Should not be airtight. Prick with a fork, if necessary.
Wax or grease-proof paper	●	Can be used to retain moisture and prevent spattering.

● : Recommended use

▲ : Limited Use

X : Not Recommended

USE YOUR MICROWAVE OVEN SAFELY

General Use

Do not attempt to defeat or tamper with safety interlocks.

Do not place any object between the oven front frame and the door or allow residue to build up on sealing surfaces. Wipe with a mild detergent, rinse and dry. Never use abrasive powders or pads.

Do not subject the oven door to strain or weight such as a child hanging on an open door.

This could cause the oven to fall forward resulting in injury to you and damage to the oven.

Do not operate the oven if door seals or sealing surfaces are damaged; or if door is bent; or if hinges are loose or broken.

Do not operate the oven empty. This will damage the oven.

Do not attempt to dry clothes, newspapers or other materials in the oven. They may catch on fire.

Do not use recycled paper products as they may contain impurities which may cause sparks or fires.

Do not hit or strike the control panel with hard objects. This can damage the oven.

Food

Never use your microwave oven for home canning. The oven is not designed for proper home canning. Improperly canned food may spoil and be dangerous to consume.

Always use the minimum recipe cooking time. It is better to undercook rather than overcook foods.

Undercooked foods can be returned to the oven for more cooking. If food is overcooked, nothing can be done.

Heat small quantities of food or foods with low moisture carefully. These can quickly dry out, burn or catch on fire.

Do not heat eggs in the shell. Pressure may build up and eggs can explode.

Potatoes, apples, egg yolks and sausages are examples of food with non-porous skins.

These must be pierced before cooking to prevent bursting.

Do not attempt to deep fat fry in your microwave oven.

Always allow a standing time of at least 20 seconds after the oven has been switched off to allow the

temperature to even out, stir during heating, if necessary, and ALWAYS stir after heating. To prevent eruptive boiling and possible scalding, you should put a spoon or glass stick into the beverages and stir before, during and after heating.

Do not leave the oven unattended while popping corn.

Do not pop corn in a paper bag unless it is the commercially prepared Microwave Popcorn product. The kernels can overheat and ignite a brown paper bag.

Do not put packaged Microwave Popcorn bags directly on the oven tray. Place the package on a microwave safe glass or ceramic plate to avoid overheating and cracking the oven tray.

Do not exceed the Microwave Popcorn manufacturers suggested popping time.

Longer popping does not yield more popcorn but it can result in scorch, burn of fire. Remember, the Popcorn bag and tray can be too hot to handle.

Remove with caution and use pot holders.

ARCING

If you see arcing, turn the timer knob the point "OFF" and correct the problem.

Arcing is the microwave term for sparks in the oven.

Arcing is caused by:

- Metal or foil touching the side of the oven.
- Foil not molded to food (upturned edges act like antennas).

- Metal, such as twist-ties, poultry pins, or gold rimmed dishes, in the microwave.
- Recycled paper towels containing small metal pieces being used in the microwave.

MICROWAVING PRINCIPLES

Microwave energy has been used in this country to cook and reheat food since early experiments with RADAR in World War II. Microwaves are present in the atmosphere all the time, both naturally and manmade sources. Manmade sources include radar, radio, television, telecommunication links and car phones.

HOW MICROWAVES COOK FOOD

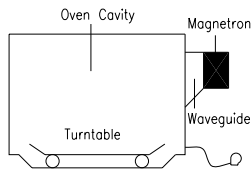

In a microwave oven, electricity is converted into microwave by the **MAGNETRON**.

► TRANSMISSION

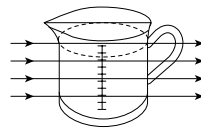

Then they pass through the cooking containers to be absorbed by the water molecules in the food, all foods contain water to a more or lesser extent.

► REFLECTION

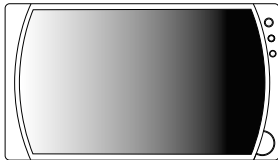

The microwaves bounce off the metal walls and the metal door screen.

► ABSORPTION

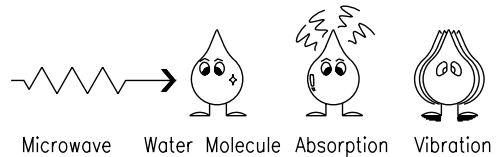

The microwaves cause the water molecules to vibrate which causes **FRICTION**, i.e. **HEAT**. This heat then cooks the food. Microwaves are also attracted to fat and sugar particles, and foods high in these will cook more quickly. Microwaves can only penetrate to a depth of 1½ - 2 inches (4-5cm) and as heat spreads through the food by conduction, just as in a traditional oven, the food cooks from the outside inwards.

CONVERSION CHARTS

WEIGHT MEASURES		VOLUME MEASURES		SPOON MEASURES	
15 g	1/2 oz.	30 ml	1 fl.oz.	1.25 ml	1/4 tsp
25 g	1 oz.	100 ml	3 fl.oz.	2.5 ml	1/2 tsp
50 g	2 oz.	150 ml	5 fl.oz. (1/4 pt)	5 ml	1 tsp
100 g	4 oz.	300 ml	10 fl.oz. (1/2 pt)	15 ml	1 tbsp
175 g	6 oz.	600 ml	20 fl.oz. (1pt)		
225 g	8 oz.				
450 g	1 lb.				

FLUID MEASUREMENTS		
1 Cup	= 8 fl.oz.	= 240 ml
1 Pint	= 16 fl.oz. (UK 20 fl.oz.)	= 480 ml (UK 560 ml)
1 Quart	= 32 fl.oz. (UK 40 fl.oz.)	= 960 ml (UK 1120 ml)
1 Gallon	= 128 fl.oz. (UK 160 fl.oz.)	= 3840 ml (UK 4500 ml)

COOKING TECHNIQUES

STANDING TIME

Dense foods e.g. meat, jacket potatoes and cakes, require standing time (inside or outside of the oven) after cooking, to allow heat to finish conducting to cook the center completely. Wrap meat joints and jacket potatoes in aluminium foil while standing. Meat joints need approx. 10-15 minutes, jacket potatoes 5 minutes. Other foods such as plated meal, vegetables, fish etc require 2-5 minutes standing. After defrosting food, standing time should also be allowed. If food is not cooked after standing time, return to the oven and cook for additional time.

MOISTURE CONTENT

Many fresh foods e.g. vegetables and fruit, vary in their moisture content throughout the season, particularly jacket potatoes. For this reason cooking times may have to be adjusted. Dry ingredients e.g. rice, pasta, can dry out during storage so cooking times may differ.

DENSITY

Porous airy foods heat more quickly than dense heavy foods.

CLING FILM

Cling film helps keep the food moist and the trapped steam assists in speeding up cooking times. Pierce before cooking to allow excess steam to escape. Always take care when removing cling film from a dish as the build-up of steam will be very hot.

SHAPE

Even shapes cook evenly. Food cooks better by microwave when in a round container rather than square.

SPACING

Foods cook more quickly and evenly if spaced apart. NEVER pile foods on top of each other.

STARTING TEMPERATURE

The colder the food, the longer it takes to heat up. Food from a fridge takes longer to reheat than food at room temperature.

LIQUIDS

All liquids must be stirred before and during heating. Water especially must be stirred before and during heating, to avoid eruption. Do not heat liquids that have previously been boiled. DO NOT OVERHEAT.

TURNING & STIRRING

Some foods require stirring during cooking. Meat and poultry should be turned after half the cooking time.

ARRANGING

Individual foods e.g. chicken portions or chops, should be placed on a dish so that the thicker parts are towards the outside.

QUANTITY

Small quantities cook faster than large quantities, also small meals will reheat more quickly than large portions.

PIERCING

The skin or membrane on some foods will cause steam to build up during cooking. These foods must be pierced or a strip of skin should be peeled off before cooking to allow the steam to escape. Eggs, potatoes, apples, sausages etc, will all need to be pierced before cooking. DO NOT ATTEMPT TO BOIL EGGS IN THEIR SHELLS.

COVERING

Cover foods with microwave cling film or a lid. Cover fish, vegetables, casseroles, soups. Do not cover cakes, sauces, jacket potatoes or pastry items.

DEFROSTING GUIDE

Do not defrost covered meat. Covering might allow cooking to take place. Always remove outer wrap and tray. Use only containers that are microwave-safe. Begin defrosting whole poultry breast-side-down. Begin defrosting roasts fat-side-down.

The shape of the package alters the defrosting time. Shallow rectangular shapes defrost more quickly than a deep block.

After $\frac{1}{3}$ of the defrost time has elapsed, check the food. Toy may wish to turn over, break apart, rearrange or remove thawed portions of the food.

During defrost, the oven will prompt you to turn the over. At this point, open oven door and check the food. Follow the techniques listed below for optimum defrost results.

Then, close oven door, touch the START pad to complete defrosting.

When defrosted, food should be cool, but softened in all areas. If still slightly icy, return to microwave oven very briefly, or let stand a few minutes. After defrosting, allow food to stand 5-60 minutes if there are any icy areas.

Poultry and fish may be placed under running cool water until defrosted

- ⇒ **Turn over** : Roast, ribs, whole poultry, turkey breasts, hot dogs, sausages, steaks, or chops.
- ⇒ **Rearrange** : Break apart or separate steaks, chops, hamburger patties, ground meat, chicken or seafood pieces, chunks of meat such as stew beef.
- ⇒ **Shield** : Use small strips of aluminum foil to protect thin areas or edges of unevenly shaped foods such as chicken wings. To prevent arching, do not allow foil to come within 1-inch of oven walls or door.
- ⇒ **Remove** : To prevent cooking, thawed portions should be removed from the oven at this point. This may shorten defrost time for food weighing less than 3 lbs.(1350g).

DEFROSTING CHART(By Time Def.)

Item & Weight	Defrosting Time	Standing Time	Special Techniques
BEEF			
Minced beef 1 lb./450g	7-9 min.	15-20 min.	Break apart and remove thawed portions with fork.
Stew Meat 1 1/2 lbs./675g	10-12 min.	25-30 min.	Separate and rearrange once.
Patties 4(4oz./110g)	7-9 min.	15-20 min.	Turn over after half the time.
PORK			
Spareribs 1 lb./450g	7-9 min.	25-30 min.	Separate and rearrange once.
Chops 4(5oz./125g)	6-8 min.	25-30 min.	Separate and turn over once.
Minced pork 1 lb./450g	7-9 min.	15-20 min.	Break apart and remove thawed portions with fork.
POULTRY			
Whole Chicken 2 1/2 lbs./1125g	17-20 min.	45-90 min.	Break side down. Turn over after half the time. Shield as needed.
Chicken Breasts 1 lbs./450g	9-11 min.	15-30 min.	Separate and rearrange once.
Fryer Chicken(cut up) 2 lbs./900g	16-18 min.	25-30 min.	Separate and rearrange once.
Chicken Thighs 1 1/2 lbs./675g	12-14 min.	15-30 min.	Separate and rearrange once.
FISH & SEAFOOD			
Whole Fish 1 lb./450g	6-8 min.	15-20 min.	Turn over after half the time. Shield as needed.
Fish Fillets 1 1/2 lb./675g	12-14 min.	15-20 min.	Separate and turn over once.
Shrimp 1/2 lb./225g	3-5 min.	15-20 min.	Separate and rearrange once.

* The times are approximate because freezer temperatures vary.

COOKING & REHEATING CHART

Cooking chart

Item	Power Level	Cooking Time Per lb./450g	Special Instruction
MEAT			
Beef joint -Rare	P-80	5-7 min.	- Chilled meat and poultry should be removed from the refrigerator at least 30 minutes before cooking. - Always let the meat and poultry stand, covered after cooking.
-Medium	P-80	6-10 min.	
-well done	P-80	8-12 min.	
Pork Joint	P-HI	9-11 min.	
Bacon joint	P-HI	6-8 min.	
POULTRY			
Whole chicken	P-HI	6-9 min.	
Portions chicken	P-80	5-8 min.	
Breast (boned)	P-80	5-7 min.	
FISH			
Fish Fillets	P-HI	4-6 min.	- Brush a little oil or melted butter over the fish, or add 15~30ml(1-2 tbsp) lemon juice, wine, stock, milk or water. - Always let the fish stand, covered, after cooking
Whole Mackerel, Cleaned and prepared	P-HI	4-6 min.	
Whole Trout, Cleaned & Prepared	P-HI	4-6 min.	
Salmon steaks	P-HI	4-6 min.	
<p>NOTE : The above times should be regarded only as a guide. Allow for difference in individual tastes and preferences. The times may vary due to the shape, cut, and composition of the food. Frozen meat, poultry and fish must be thoroughly thawed before cooking.</p>			

Reheating chart

- Baby food particularly needs to be checked carefully before serving to prevent burns.
- When heating pre-packaged ready-cooked foods, always follow the pack instructions carefully.
- If you freeze foods which were bought from the fresh or chilled counters, remember that they should be thoroughly thawed before following the heating instructions on the packed. It's worth putting a note on them so that other members of the household will remember too.
- Remember metal ties and transfer food from foil containers before reheating.
- Chilled(refrigerated) food takes longer to reheat than food at room temperature (such as just-cooled food or food from the store cupboard).
- All foods should be reheated using full microwave power.

Item	Cooking time	Special Instructions
Baby food 128g jar	30 sec.	Empty into a small serving bowl. Stir well once or twice during heating. Before serving, check the temperature carefully.
Baby milk 100ml / 4fl.oz. 225ml / 8fl.oz.	20-30 sec. 40-50 sec.	Stir or shake well and pour into a sterilized bottle. Before serving, shake well and check the temperature carefully.
Sandwich roll or bun 1 roll	20-30 sec.	Wrap in paper towel and place on glass microwaveable rack. *Note : Do not use recycled paper towels.
Lasagna 1 serving (10 1/2 oz./300g)	4-6 min.	Place lasagna on microwaveable plate. Cover with plastic wrap and vent.
Casserole 1 cup 4 cups	1-2 min. 4-6 min.	Cook covered in microwaveable casserole. Stir once halfway through cooking.
Mashed potatoes 1 cup 4 cups	2-3 min. 6-8 min.	Cook covered in microwaveable casserole. Stir once halfway through cooking.
Baked beans 1 cup	2-3 min.	Cook covered in microwaveable casserole. Stir once halfway through cooking.
Ravioli or pasta in sauce 1 cup 4 cups	3-4 min. 7-10 min.	Cook covered in microwaveable casserole. Stir once halfway through cooking.

VEGETABLE CHART

Use a suitable glass pyrex bowl with lid. Add 30-45ml cold water(2-3 tbsp.) for every 250g unless another water quantity is recommended - see table. Cook covered for the minimum time - see table. Continue cooking to get the result you prefer. Stir once during and once after cooking. Add salt, herbs or butter after cooking. Cover during a standing time of 3 minutes.

Hint : cut the fresh vegetables into even sized pieces. The smaller they are cut, the quicker they will cook.

All vegetables should be cooked using full microwave power.

Cooking Guide for fresh vegetables

Vegetables	Weight	Time	Comments
Broccoli	1 lb./250g 2 lb./500g	3-4 min 5-7 min	Prepare even sized florets. Arrange the stems to the centre.
Brussels sprouts	1 lb./250g	4-5 min	Add 60-75ml(5-6tbsp.) water.
Carrots	1 lb./250g	3-4 min	Cut carrots into even sized slices.
Cauliflower	1 lb./250g 2 lb./500g	3-4 min 5-7 min	Prepare even sized florets. Cut big florets into halves. Arrange stems to the centre.
Courgettes	1 lb./250g	3-4 min	Cut courgettes into slices. Add 30ml(2tbsp.) water or a knob of butter. Cook until just tender.
Egg plants	1 lb./250g	3-4 min	Cut egg plants into small slices and sprinkle with 1 tablespoon lemon juice.
Leeks	1 lb./250g	3-4 min	Cut leeks into thick slices.
Mushrooms	0.5 lb./125g 1 lb./250g	2-3 min 3-5 min	Prepare small whole or sliced mushrooms. Do not add any water. Sprinkle with lemon juice. Spice with salt and pepper. Drain before serving.
Onions	1 lb./250g	3-4 min	Cut onions into slices or halves. Add only 15ml(1tbsp.) water.
Pepper	1 lb./250g	3-5 min	Cut pepper into small slices.
Potatoes	1 lb./250g 2 lb./500g	3-5 min 8-10 min	Weigh the peeled potatoes and cut them into similar sized halves or quarters.
Turnip cabbage	1 lb./250g	5-7 min	Cut turnip cabbage into small cubes.

Cooking Guide for frozen vegetables

Vegetables	Weight	Time	Instructions
spinach	0.5 lb./125g	2-3 min	Add 15ml(1tbsp.) cold water.
broccoli	1 lb./250g	3-4 min	Add 30ml(2 tbsp.) cold water.
Peas	1 lb./250g	3-4 min	Add 15ml(1 tbsp.) cold water.
Green beans	1 lb./250g	4-5 min	Add 30ml(2t tbsp.) cold water.
Mixed vegetables (carrots/peas/corn)	1 lb./250g	3-5 min	Add 15ml(1tbsp.) cold water.
Mixed vegetables (Chinese style)	1 lb./250g	4-6 min	Add 15ml(1 tbsp.) cold water.

RECIPES

TOMATO & ORANGE SOUP

1 oz.(25g) butter
1 medium onion, chopped
1 large carrot & 1 large potato, chopped
1³/₄lb(800g) canned, chopped tomatoes
juice and grated rind of 1 small orange
1¹/₂pints(900ml) hot vegetable stock
salt and pepper to taste

1. Melt the in a large bowl at P-HI for 1 minute.
2. Add the onion, carrot and potato and cook at P-HI for 6 minutes. stir halfway through cooking.
3. Add the tomatoes, orange juice, orange rind and stock. Mix thoroughly. Season with salt and pepper to taste. Cover the bowl and cook at P-HI for 14 minutes. stir 2-3 times during cooking, until the vegetables are tender.
4. Blend and serve immediately.

FRENCH ONION SOUP

1 large onions, sliced
1 tbsp (15ml) corn oil
2 oz.(50g) plain flour
2 pints(1.2 liters) hot meat
or vegetable stock
salt and pepper to taste
2 tbsp (30ml) parsley, chopped
4 thick slices French bread
2 oz.(50g) cheese, grated

1. Place the onion and oil a bowl, mix well and cook at P-HI for 2 minutes.
2. Stir in the flour to make a paste and gradually add stock. Season and add the parsley.
3. Cover the bowl and cook at P-80 for 14 minutes.
4. Pour the soup into serving bowls, submerge bread and sprinkle generously with cheese.
5. Cook at P-80 for 2 minutes, until the cheese has melted.

STIR FRIED VEGETABLES

1 tbsp(15ml) sunflower oil
2 tbsp (30ml) soy sauce
1 tbsp (15ml) sherry
1"(2.5cm) root ginger,
peeled and finely grated
2 medium carrots, cut into fine strips
4 oz.(100g) button mushrooms,
chopped
2 oz.(50g) beansprouts
4 oz.(100g) mange-tout
1 red pepper, seeded and thinly sliced
4 spring onions, chopped
4 oz.(100g) canned water chestnuts,
sliced
1/4 head of chinese leaves, thinly sliced

1. Place the oil, soy sauce, sherry, ginger, garlic and carrots in a large bowl, mix thoroughly
2. Cover and cook at P-HI for 4-5 minutes, stirring once.
3. Add the button mushrooms, beansprouts, mange-tout, red pepper, spring onions, water chestnuts and chinese leaves. Mix thoroughly.
4. Cook at P-HI for 4-5 minutes, until the vegetables are tender. Stir 2-3 times during cooking.

Stir fried vegetables are ideally served with meat or fish.

HONEYED CHICKEN

4 boneless chicken breasts
2 tbsp(30ml) clear honey
1 tbsp(15ml) whole grain mustard
1/2 tsp(2.5ml) dried tarragon
1 tbsp(15ml) tomato puree
1/4 pint(150ml) chicken stock

1. Place the chicken breasts in a casserole dish.
2. Mix all remaining ingredients together and pour over the chicken. Salt and pepper to taste.
3. Cook at P-HI for 10-11 minutes. Rearrange and coat the chicken with the sauce twice during cooking.

BLUE CHEESE & CHIVE JACKETS

2 baking potatoes,
(approx.9 oz.(250g) each)
2 oz.(50g) butter
4 oz.(100g) blue cheese, chopped
1 tbsp(15ml) fresh chives, chopped
2 oz.(50g) mushrooms, sliced
salt and pepper to taste

1. Prick each potato in several places. Cook at P-HI for 10-11 minutes. Halve and scoop the flesh into a bowl, add the butter, cheese, chives, mushrooms, salt and pepper, mix thoroughly.
2. Pile mixture into the potato skins and place in a flan dish, on the rack.
3. Cook at P-80 for 10 minutes.

WHITE SAUCE

1 oz.(25g) butter
1 oz.(25g) plain flour
1/2 pint(300ml) milk
salt and pepper to taste

1. Place the butter in a bowl and cook at P-HI for 1 minute, until melted.
2. Stir in the flour and whisk in the milk. Cook at P-HI for 3-4 minutes, stirring every 2 minutes until thick and smooth. Season with salt and pepper to taste.

STRAWBERRY JAM

1 1/2 lb.(675g) strawberries, hulled
3 tbsp(45ml) lemon juice
1 1/2 lb.(675g) caster sugar

1. Place strawberries and lemon juice in a very large bowl, heat at P-HI for 5 minutes, or until the fruit has softened. Add sugar, mix well.
2. Cook at P-80 for 23-28 minutes, until setting point*is reached, stir every 4-5 minutes.
3. Pour into hot, clean jars. Cover, seal and label.

** setting point : To determine setting point, place 1 tsp(5ml)jam onto chilled saucer. Allow to stand for 1 minute. Move surface of jam gently with your finger, if the surface wrinkles setting point has been reached.*

PLAIN MICROWAVE CAKE

4 oz.(100g) margarine
4 oz.(100g) sugar
1 eggs
4 oz.(100g) self raising flour, sifted
2-3 tbsp(30-45ml) milk

1. line the base of 8" (20.4cm) cake dish with grease-proof paper.
2. Cream the margarine and sugar together until light and fluffy. Beat in the eggs and fold in the sifted flour alternately with the milk.
3. Pour into prepared container. Cook at P-HI for 3-4 minutes, until a skewer comes out cleanly.
4. Leave the cake to stand for 5 minutes before turning out.

OMELETTES

1/2 oz.(15g) butter
4 eggs
6 tbsp(90ml) milk
salt & pepper

1. Whisk together eggs and milk. Season.
2. Place butter in 10"(26cm) flan dish. Cook at P-HI for 1 minute, until melted. Coat the dish with the melted butter.
3. Pour omelette mixture into flan dish. Cook at P-HI for 2 minutes. whisk mixture and cook again at P-HI for 1 minutes.

SCRAMBLED EGG

1/2 oz.(15g) butter
2 eggs
2 tbsp(30ml) milk
salt & pepper

1. Melt the butter in a bowl at P-HI for 1 minutes.
2. Add the eggs, milk and seasoning and mix well.
3. Cook at P-HI for 2 minutes, stirring every 30 seconds.

SAVORY MINCE

1 small onion, diced
1 clove garlic, crushed
1 tsp(5ml) oil
7 oz.(200g) can chopped tomatoes
1 tbsp(15ml) tomato puree
1 tsp(5ml) mixed herbs
8 oz.(225g) minced beef
salt and pepper

1. Place onion, garlic and oil in casserole, and cook at P-HI for 2 minutes or until soft.
2. Place all other ingredients in casserole. Stir well.
3. Cover and cook at P-HI for 4 minutes then P-80 for 7-11 minutes or until the meat is cooked.

Free Manuals Download Website

<http://myh66.com>

<http://usermanuals.us>

<http://www.somanuals.com>

<http://www.4manuals.cc>

<http://www.manual-lib.com>

<http://www.404manual.com>

<http://www.luxmanual.com>

<http://aubethermostatmanual.com>

Golf course search by state

<http://golfingnear.com>

Email search by domain

<http://emailbydomain.com>

Auto manuals search

<http://auto.somanuals.com>

TV manuals search

<http://tv.somanuals.com>