

DAEWOO

TV / DVD COMBO

OWNER'S MANUAL

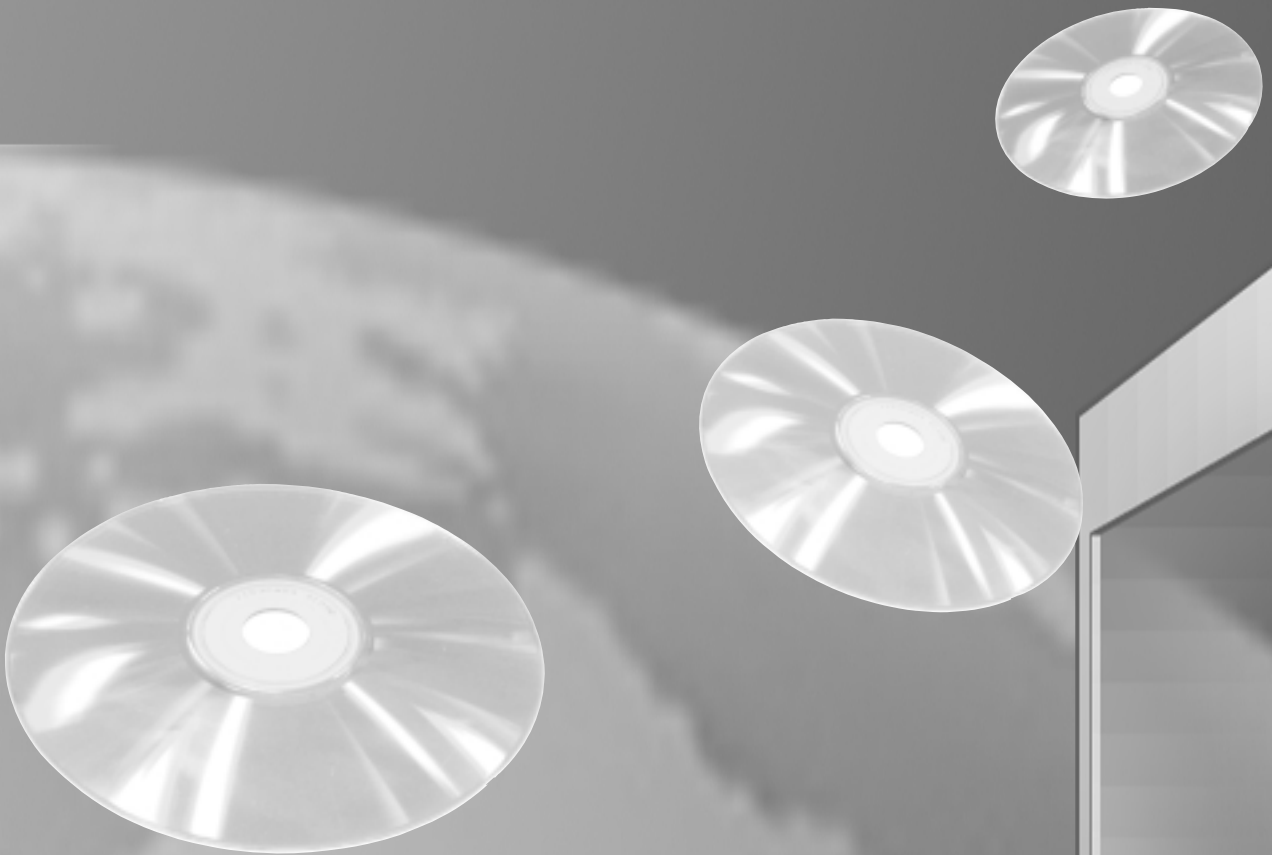

Model:

• DDQ-20L6SC



	CAUTION RISK OF ELECTRIC SHOCK DO NOT OPEN	
CAUTION : TO REDUCE THE RISK OF ELECTRIC SHOCK, DO NOT REMOVE COVER (OR BACK) NO USER-SERVICEABLE PARTS INSIDE. REFER SERVICING TO QUALIFIED SERVICE PERSONNEL.		

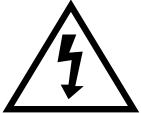

The lightning flash with arrowhead symbol, within an equilateral triangle, is intended to alert the user to the presence of uninsulated "dangerous voltage" within the product's enclosure that may be of sufficient magnitude to constitute a risk electric shock.



The exclamation point within an equilateral triangle is intended to alert the user to the presence of important operating and servicing instructions in the literature accompanying the appliance.

WARNING

TO PREVENT FIRE OR SHOCK HAZARD, DO NOT EXPOSE THIS APPLIANCE TO RAIN OR MOISTURE.

CAUTION

CHANGES OR MODIFICATIONS NOT EXPRESSLY APPROVED BY THE MANUFACTURER COULD VOID THE USER'S AUTHORITY TO OPERATE THE EQUIPMENT.

NOTE TO CATV SYSTEM INSTALLER

THIS REMINDER IS PROVIDED TO CALL THE CATV SYSTEM INSTALLER'S ATTENTION TO ARTICLE 820-40 OF THE NEC THAT PROVIDES GUIDELINES FOR PROPER GROUNDING AND, IN PARTICULAR, SPECIFIES THAT THE CABLE GROUND SHALL BE CONNECTED TO THE GROUNDING SYSTEM OF THE BUILDING, AS CLOSE TO THE POINT OF CABLE ENTRY AS PRACTICAL.

CAUTION

The AC power cord provided with this product is polarized (one blade wider than the other). To prevent electrical shock, match wide blade of plug to wide slot, fully insert the AC plug into a standard 120V~, 60Hz polarized outlet.

NOTE

Never connect the plug to an electrical source other than one providing 120V~, 60Hz power. Use only the attached power cord. If the polarized AC cord does not fit into a non-polarized outlet, do not cut or file the blade. You are responsible for having the obsolete outlet replaced with a polarized outlet.

If you feel a static discharge when touching the unit, and the unit does not function, simply unplug the unit from the outlet. When you plug the unit back in, it should work normally.

Do not install power cords near any heating element or cooking appliances.

NOTICE

This product incorporates copyright protection technology that is protected by method claims of certain U.S. patents and other intellectual property rights owned by Macrovision Corporation and other rights owners. Use of this copyright protection technology must be authorized by Macrovision Corporation, and is intended for home and other limited viewing uses only unless otherwise authorized by Macrovision Corporation. Reverse engineering or disassembly is prohibited.

IMPORTANT SAFEGUARDS

- 1 Read Instructions** - All the safety and operating instructions should be read before the appliance is operated.
- 2 Retain Instructions** - The safety and operating instructions should be retained for future reference.
- 3 Heed Warnings** - All warnings on the appliance and in the operating instructions should be adhered to.
- 4 Follow Instructions** - All operating and use instructions should be followed.
- 5 Cleaning** - Unplug TV/DVD from the wall outlet before cleaning. Do not use liquid cleaners or aerosol cleaners. Use a damp cloth for cleaning.
- 6 Attachments** - Do not use attachments not recommended by the TV/DVD manufacturer as they may cause hazards.
- 7 Water and Moisture** - The apparatus shall not be exposed to dripping or splashing water and that no object filled with liquids, such as vases, shall be placed on the apparatus.
- 8 Accessories** - Do not place this TV/DVD on an unstable cabinet, stand, bracket, or table. The TV/DVD may fall, causing serious injury to someone, and serious damage to the appliance. Use only with a cabinet, stand, bracket, or table recommended by the manufacturer, or sold with the TV/DVD. Any mounting of the appliance should follow the manufacturer's instructions and use a mounting accessory recommended by the manufacturer. An appliance and cart combination should be moved with care. Quick stops, excessive force, and uneven surfaces may cause the appliance and cabinet combination to overturn.
PORTABLE CABINET WARNING

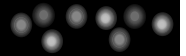
- 9 Ventilation** - Slots and openings in the cabinet and the back or bottom are provided for ventilation and to ensure reliable operation of the TV/DVD and to protect it from overheating, and these openings must not be blocked or covered. The openings should never be blocked by placing the TV/DVD on a bed, sofa, rug, or other similar surface. This TV/DVD should never be placed near or over a radiator or heat register. This TV/DVD should not be placed in a built-in installation such as a bookcase or rack unless proper ventilation is provided or the manufacturer's instructions have been adhered to. Around the unit, the space should be more than 10cm.
- 10 Power Sources** - This TV/DVD should be operated only from the type of power source indicated on the marking label. If you are not sure of the type of power supply to your home, consult your appliance dealer or local power company.
- 11 Grounding or Polarization** - This TV/DVD is equipped with a polarized alternating-current line plug (a plug having one blade wider than the other). This plug will fit into the power outlet only one way. This is a safety feature. If you are unable to insert the plug fully into the outlet, contact your electrician to replace your obsolete outlet. Do not defeat the safety purpose of the polarized plug.
- 12 Power-Cord Protection** - Power-supply cords should be routed so that they are not likely to be walked on or pinched by items placed upon or against them, paying particular attention to cords at plugs, and the point where they exit from the appliance.
- 13 Lightning** - For added protection for this TV/DVD receiver during a lightning storm, or when it is left unattended and unused for long periods of time, unplug it from the wall outlet and disconnect the antenna or cable system. This will prevent damage to the TV/DVD due to lightning and power-line surges.
- 14 Power Lines** - An outside antenna system should not be located in the vicinity of overhead power lines or other electric light or power circuits, or where it can fall into such power lines or circuits. When installing an outside antenna system, extreme care should be taken to keep from touching such power lines or circuits as contact with them might be fatal.



- 15 **Overloading** - Do not overload wall outlets and extension cords as this can result in a risk of fire or electric shock.
- 16 **Object and Liquid Entry** - Never push objects of any kind into this TV/DVD through openings as they may touch dangerous voltage points or short out parts that could result in a fire or electric shock. Never spill liquid of any kind on the TV/DVD.
- 17 **Servicing** - Do not attempt to service this TV/DVD yourself as opening or removing covers may expose you to dangerous voltage or other hazards. Refer all servicing to qualified service personnel.
- 18 **Damage Requiring Service** - Unplug this TV/DVD from the wall outlet and refer servicing to qualified service personnel under the following conditions:
 - A. When the power-supply cord or plug is damaged or frayed.
 - B. If liquid has been spilled, or objects have fallen into the TV/DVD.
 - C. If the TV/DVD has been exposed to rain or water.
 - D. If the TV/DVD does not operate normally by following the operating instructions. Adjust only those controls that are covered by the operating instructions, as improper adjustment of other controls may result in damage and will often require extensive work by a qualified technician to restore the TV/DVD to its normal operation.
 - E. If the TV/DVD has been dropped or damaged in any way.
 - F. When the TV/DVD exhibits a distinct change in performance - this indicates a need for service.
- 19 **Replacement Parts** - When replacement parts are required, be sure the service technician has used replacements parts specified by the manufacturer that have the same characteristics as the original part. Unauthorized substitutions may result in fire, electric shock, injury to persons or other hazards.
- 20 **Safety Check** - Upon completion of any service or repairs to this TV/DVD, ask the service technician to perform routine safety checks to determine that the TV/DVD is in proper operating condition.
- 21 **Heat** - This TV/DVD product should be situated away from heat sources such as radiators, heat registers, stoves, or other products (including amplifiers) that produce heat.
- 22 **Electrostatic** - In DVD mode, your DVD Disc may be playback from the first parts because of the electrostatic symptom.
- 23 **Secondary Switch** - When switching off, the apparatus is not completely switched off from the mains. To disconnect it from the mains, you have to unplug mains.

Precautions in use



LOCATION

For safe operation and satisfactory performance of your unit, keep the following in mind when selection a place for its installation :

- Shield it from direct sunlight and keep it away from sources of intense heat.
- Avoid dusty or humid places.
- Avoid places with insufficient ventilation for proper heat dissipation. Do not block the ventilation holes at the top and bottom of the unit.
Do not place the unit on a carpet because this will block the ventilation holes.
- Install the unit in a horizontal position.
- Avoid locations subject to strong vibration.
- Do not place the unit near strong magnetic fields.
- Do not move the unit from a cold place to a hot place or vice versa (see the warning below).

AVOID THE HAZARDS OF ELECTRICAL SHOCK AND FIRE

- Do not handle the power cord with wet hands.
- Do not pull on the power cord when disconnecting it from an ac wall outlet. grasp it by plug.
- If, by accident, water is spilled on your unit, unplug the power cord immediately and take the unit to an authorized daewoo service center for servicing.
- Do not put your fingers or objects into the TV/DVD Disc holder.
- Do not place anything directly on top of the unit.

WARNING

Moisture condensation may occur inside the unit when it is moved from a cold place to a warm place, after heating in a cold room, or under conditions of high humidity. if a tape is played in a TV/DVD that has moisture, it may damage the Disc and TV/DVD. when condensation occurs inside the unit, turn the power on and allow at least 2 hours for the unit to dry.

FCC WARNING

This equipment may generate or use radio frequency energy. changes or modifications to this equipment may cause harmful interference unless the modifications to this equipment may cause harmful interference unless the modifications are expressly approved in the instruction manual.

The user could lose the authority to operate this equipment if an unauthorized change or modification is made.

IMPORTANT COPYRIGHT INFORMATION

Unauthorized recording or use of broadcast television programming, video tape, film, or other copyrighted material may violate applicable copyright laws. we assume no responsibility for the unauthorized duplication, use or other acts which infringe upon the rights of copyright owners.

LASER SAFETY

This unit employs a laser. Only a qualified service person should remove the cover or attempt to service this device, due to possible eye injury.

CAUTION

USE OF CONTROLS OR ADJUSTMENTS OR PERFORMANCE OF PROCEDURES OTHER THAN THOSE SPECIFIED HEREIN MAY RESULT IN HAZARDOUS RADIATION EXPOSURE.

DAEWOO

Table of Contents

Before use

IMPORTANT SAFEGUARDS	1
Precautions in use	3
Table of Contents	4
Identification of Controls	5
(Front Panel, Back Panel, Remote Control)	

Installation

Basic Installation	10
Connecting to Various Equipment	11

Basic TV operation

Watching TV.....	15
Setting TV	16
To Display the Setting Screen	16
Setting Video	17
Setting Audio	18
Setting Time	19
Setting Set up	20
Setting Special	21

DVD Operation

Playing a DVD video disc	25
Basic Playback	25
Special Playback	26
Using DISPLAY Buttons	28
Playing the Desired Scene or	
Track during Playback	30
Directly Moving to the Desired Title	30
Playing the Disc, Chapter,	
Title, and Track Repeatedly	31
Repeating the Given Sections	31
Searching by Memorizing the Favorite	
Scene	32
Displaying menus in disc	33
Storing viewed DVD settings	34
Changing subtitle Language	35
Changing audio language	36
Using zoom feature	37
Viewing from Another Angle or Producing a	
3D SURROUND Effect	38
Random play	39
Program play	40
Playing an MP3 Disc	41
Playing Repeatedly and Editing the Programmed	
Mp3 File	43
Initial Settings	44

Others

About DVD	53
Before calling service personnel	55
Warranty	56

IMPORTANT COPYRIGHT INFORMATION

Unauthorized copying, broadcasting, public performance and lending of discs are prohibited.

Identification of Controls

Main Body (Front Part)

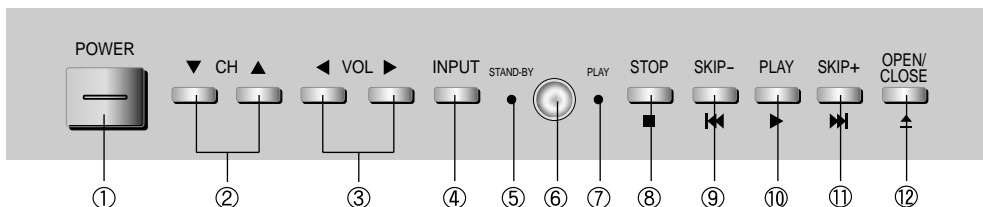
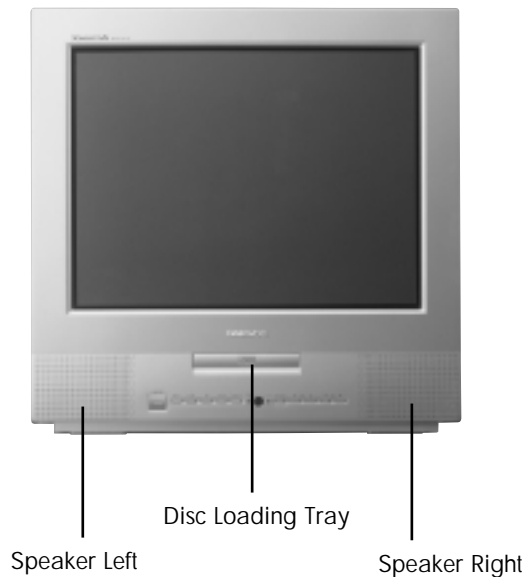

- ① POWER button (Power of TV/DVD is fully intercepted.)
- ② CHANNEL ▼, ▲ button
- ③ TV VOLUME ◀, ▶ button
- ④ INPUT button : You can select an item from TV, AV1, AV2, DVD.
- ⑤ STAND-BY indicator
- ⑥ REMOTE SENSOR
- ⑦ PLAY indicator
- ⑧ STOP ■ button
- ⑨ SKIP- ◀◀ button
- ⑩ PLAY ▶ button
- ⑪ SKIP+ ▶▶ button
- ⑫ OPEN/CLOSE ▲ button

Main Body (Rear and Side Part)

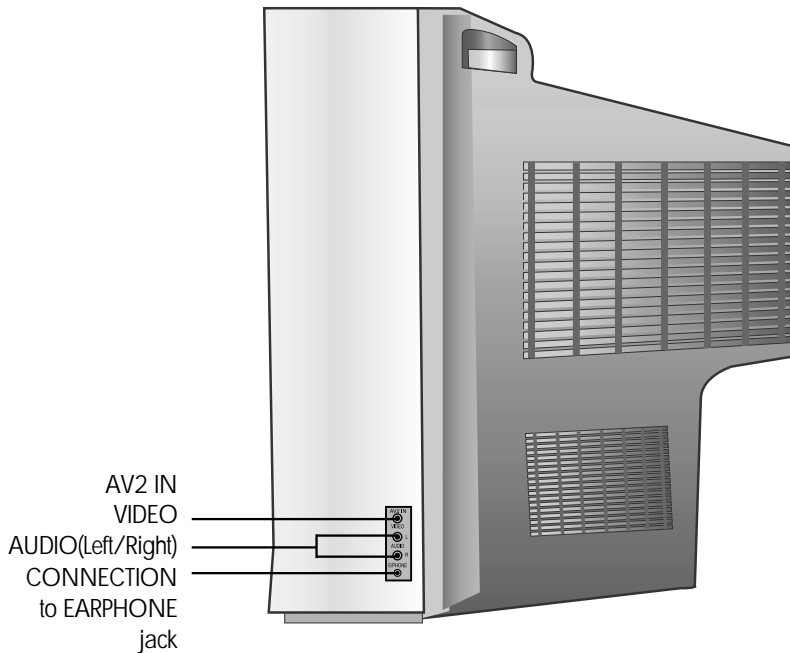
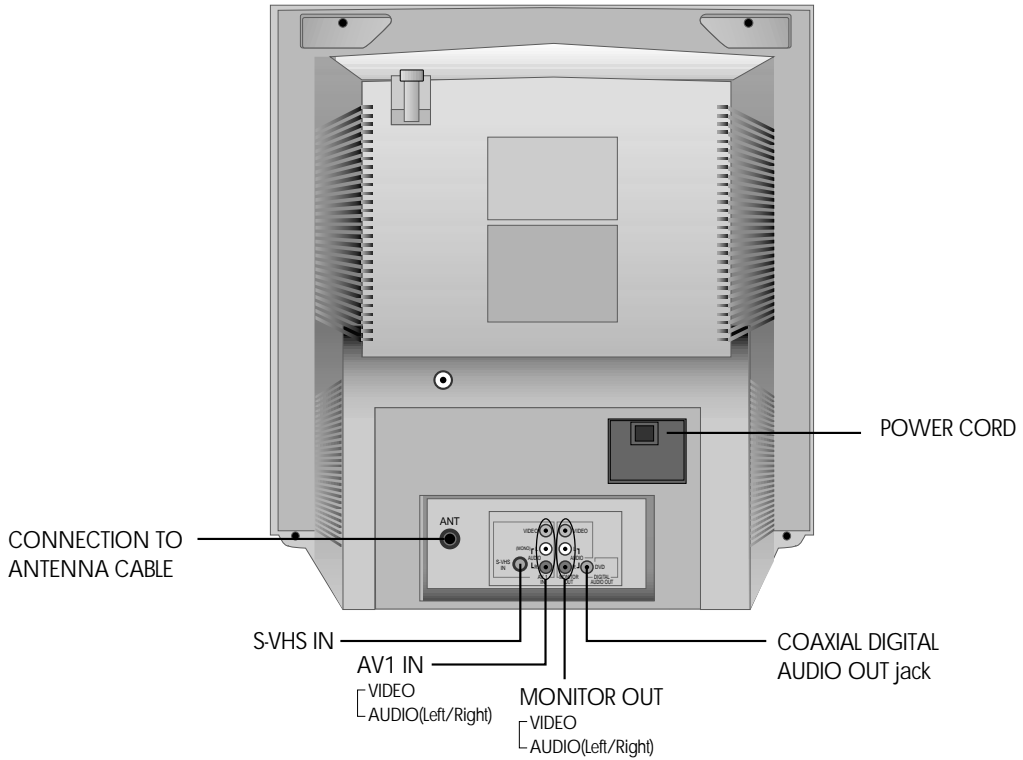

Remote Control Buttons

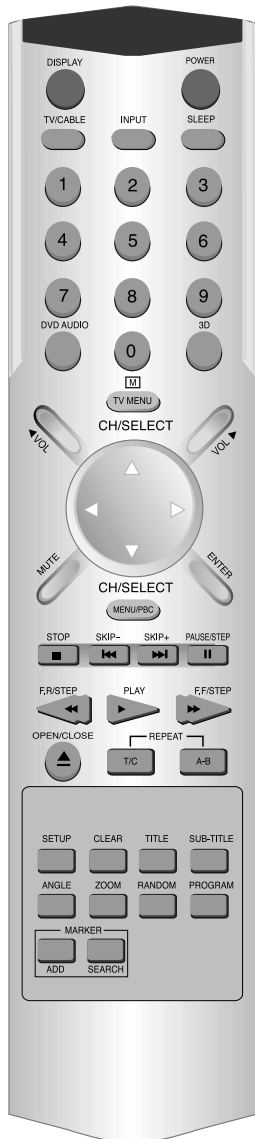

POWER



POWER button

If you press the ON/OFF button in the front part of this product, power is on.

DISPLAY



DISPLAY button

Operating status and MENU are displayed in a screen.

SLEEP



SLEEP button

You can set automatic POWER OFF.

INPUT



INPUT button

You can select input mode(TV -> AV1 -> AV2 -> DVD).

TV/CABLE



TV/CABLE button

You can select air or cable.

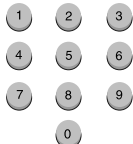

NUMBER button

You can enter the relevant number directly or select a desired channel.

DVD AUDIO



DVD AUDIO button

You can select the desired audio language.

3D



3D button

You can select NORM or 3D surround.



VOLUME button

TV MENU



TV MENU button

CH/SELECT



CURSOR(▲▼◀▶), CHANNEL SELECT button

This button functions as cursor or channel select button in setting TV/DVD and operating TV respectively.

CH/SELECT



MUTE button

Press this button if you only want to turn off the sound.



ENTER button

Press this button if DVD setting is completed.

MENU/PBC



MENU/PBC button

The DVD menu screen is displayed.

STOP



STOP button

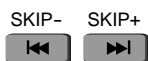

SKIP BACK/SKIP FORWARD button

You can skip a screen while playing back or forward.

PAUSE/STEP



PAUSE/STEP button

Pause screen and step screen are displayed while playing and pausing respectively.

PLAY



PLAY button



F.R./STEP or F.F./STEP button

You can search screen while playing back or forward.

OPEN/CLOSE



DISC TRAY OPEN/CLOSE button

T/C button

You move into REPEAT mode whenever you press this button.



A-B button

You can play the given sections repeatedly.

SETUP



SETUP button

You can set the DVD player.

CLEAR



CLEAR button

You can clear settings.

TITLE



TITLE button

You can select the desired title.

SUB-TITLE



SUBTITLE button

You can select the desired subtitle language.

ANGLE



Angle button

You can select the desired screen angle.

ZOOM



ZOOM button

You can zoom in a screen.

RANDOM



RANDOM button

You can play and CD randomly.

PROGRAM



PROGRAM button

You can program the desired playing order.

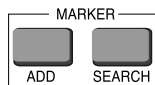

ADD button

You can mark the desired scene.

SEARCH button

You can reach the marked scene.

This button functions as a Marker Search button in DVD.

Inserting the Batteries

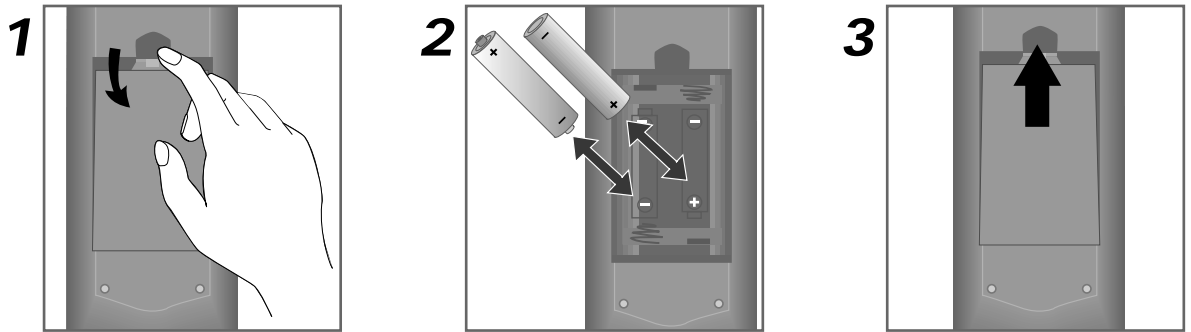

Please respect the environment and prevailing regulations. Before you dispose of batteries, ask your dealer whether they are subject to special recycling and if he accepts to take them back.

AERIAL SOCKET : (75Ohms-VHF/UHF/cable)

The aerial socket, located at the back of the TV/DVD set, enables the connection of an external aerial or one from another item of equipment fitted with a modulator (video recorder, satellite receiver, etc.).

(NB: A modulator converts basic video and sound signals to radio frequencies, 'R.F.'.)

MAINS PLUG:

The mains plug carries the power supply to your TV/DVD set. It should only be connected to an AC supply of 120V ~ 60Hz.

It must not be connected to a DC supply. If the plug is detached from the cable, do not under any circumstances connect it to a mains socket as there is a danger of electrocution.

Connecting the Antenna Cable

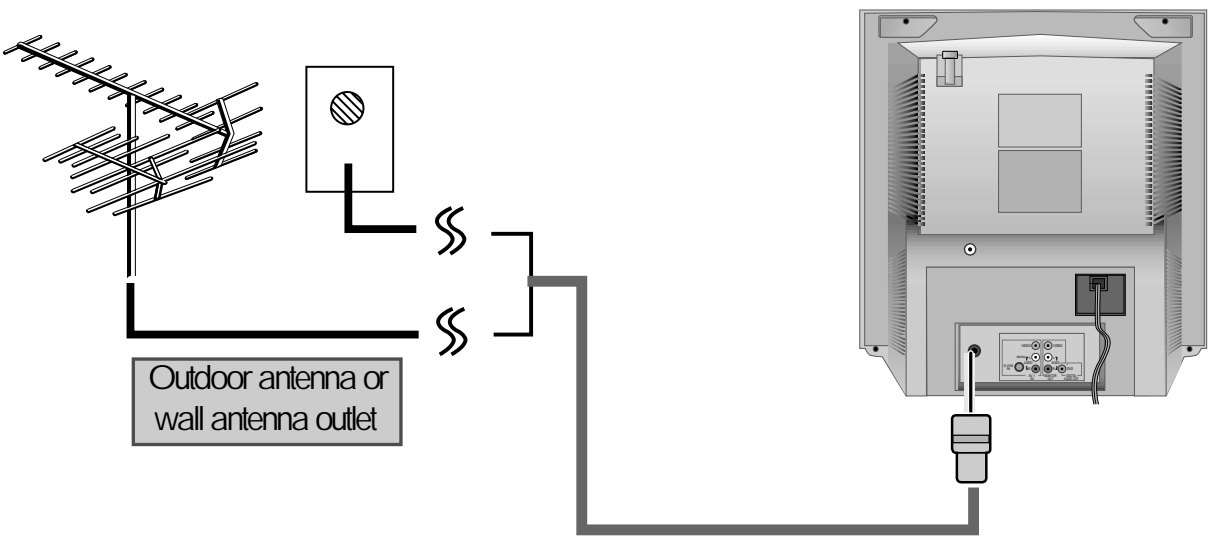

If TV picture is not clear, it usually result from the wrong antenna connection.
Please install the antenna in the proper place and in the right direction.

Connecting to Various Equipment

Connecting to Audio System

You can enjoy the stereo sound.

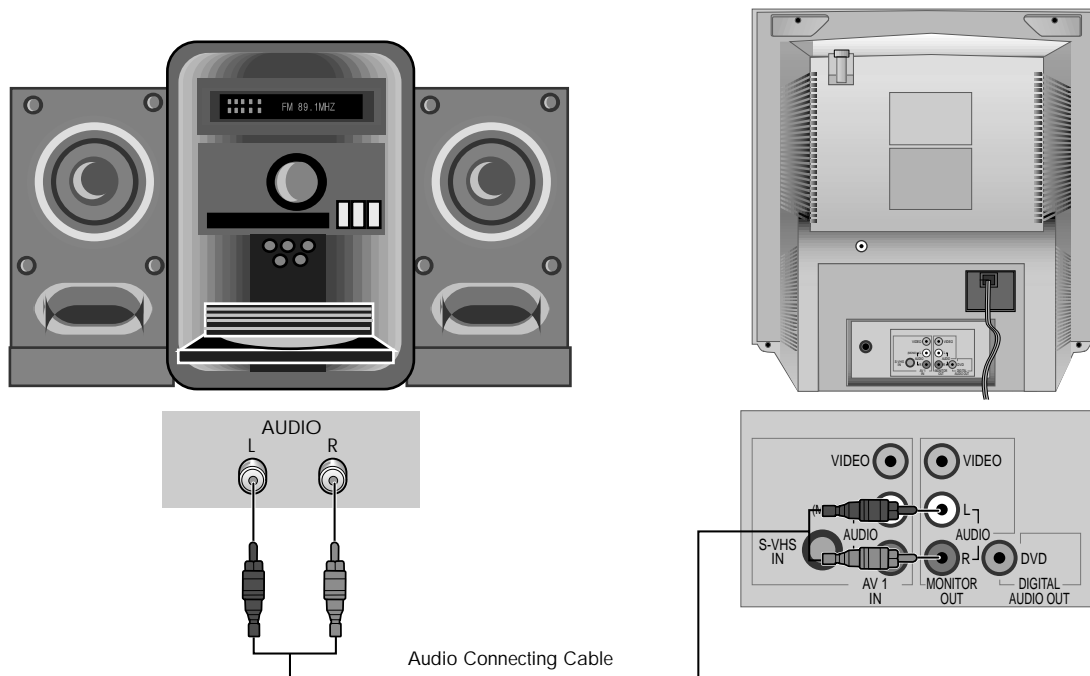

NOTE

- Refer to the owner's manual of your audio system to connect.
- Before you connect the TV/DVD to other equipment, be sure to turn off the power and unplug all of the equipment from the wall outlet before making any connections.
- If you place the TV/DVD near a tuner or radio, the radio broadcast sound might be distorted. In this case, move the TV/DVD away from the tuner and radio.
- The output sound of TV/DVD has a wide dynamic range. Be sure to adjust the receiver's volume to a moderate listening level. Otherwise, the speakers may be damaged by a sudden high volume sound.
- Turn off the audio system before you connect or disconnect the TV/DVD's power cord. If you leave the audio system power on, the speakers may be damaged.

Warning!!



Do not select "Dolby Digital" as Digital Audio Output of this TV/DVD unless you connect the DIGITAL OUT jack of this TV/DVD to an AV decoder that has the Dolby Digital decoding equipment.

High volume sound may damage your hearing as well as the speakers.
(Refer to "Selecting Digital Audio Output" on page 51)

Connecting to a Camcorder or Other Video Player

■ Connection with A/V Jack (AV1 IN)

Connect the AUDIO/VIDEO OUT terminal of your camcorder (or video player) to AV1 IN of TV/DVD with Video/Audio Connecting Cable.

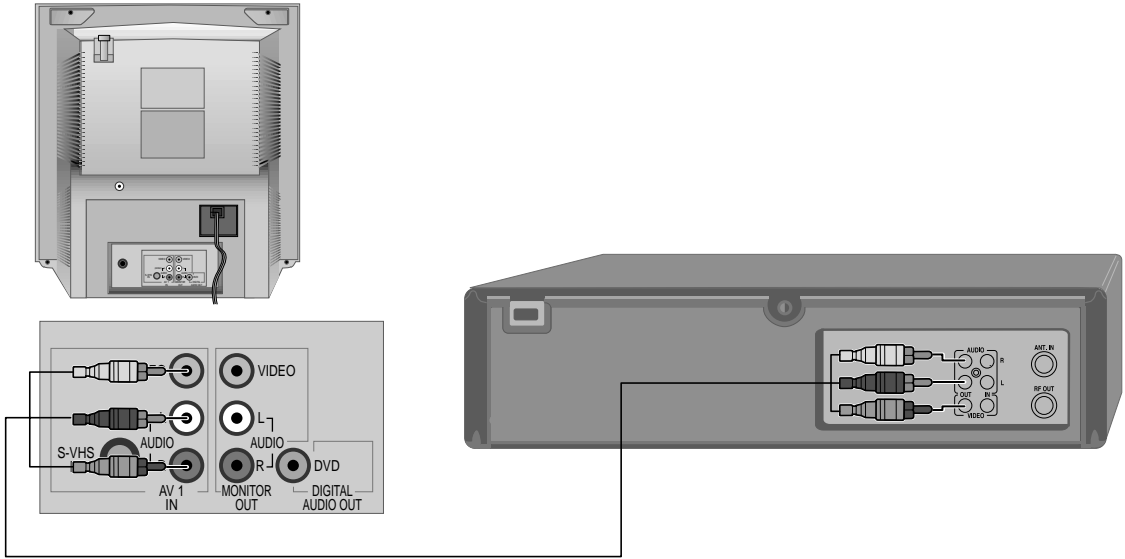

■ Connection with A/V Jack (AV2 IN)

Connect the AUDIO/VIDEO OUT terminal of your camcorder (or video player) to AV2 IN of TV/DVD with Video/Audio Connecting Cable.

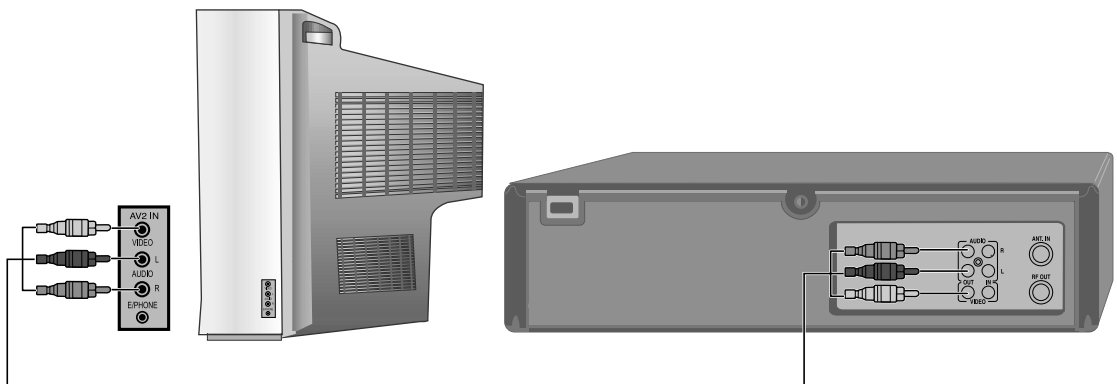

Connecting to Dolby Digital Amp

You can enjoy the high quality dynamic sound of Dolby Digital, Dolby Pro Logic, and 2 Channel Digital Stereo.

Dolby Digital?

Dolby Digital is the surround sound technology recently used in theatres, and is now available to reproduce this realistic effect at home. You can enjoy motion picture and live concert DVD video discs with this dynamic realistic sound by connecting the TV/DVD to the 6 channel amp equipped with a Dolby Digital decoder or Dolby Digital processor.

Amp equipped with Dolby Digital decoder

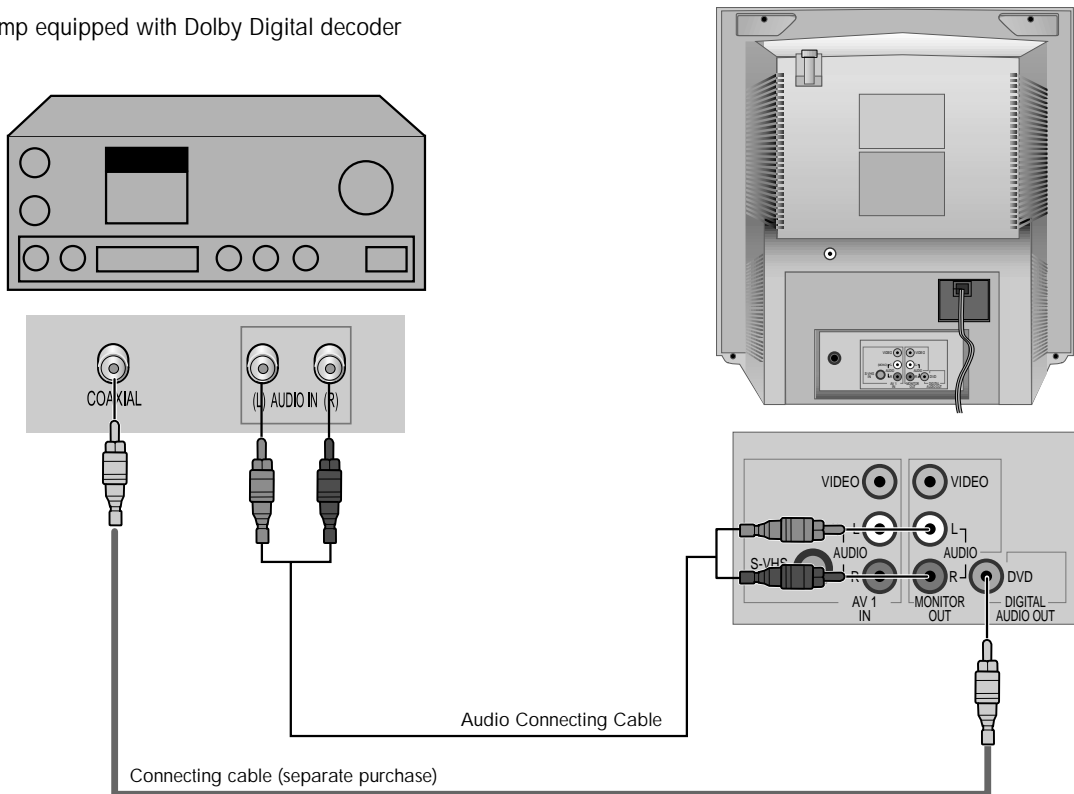

- 1 To enjoy Dolby Digital sound from this TV/DVD, you need the following:
 - DVD recorded in Dolby Digital
 - 6 channel amp equipped with a Dolby Digital decoder or Dolby Digital processor and power amp
 - 5 speakers and 1 subwoofer

- 2 To enjoy Dolby Digital sound
 - You need to select "Dolby Digital" in the SETUP menu.

N O T E

- Refer to the owner's manual of your audio system to connect.
- Before you connect the TV/DVD to other equipment, be sure to turn off the power and unplug all of the equipment from the wall outlet before making any connections.
- The output sound of TV/DVD has a wide dynamic range. Be sure to adjust the receiver's volume to a moderate listening level. Otherwise, the speakers may be damaged by a sudden high volume sound.
- Turn off the audio system before you connect or disconnect the TV/DVD's power cord. If you leave the audio system power on, the speakers may be damaged.

This product has been manufactured under technical tie-up with Dolby Laboratories.

"Dolby" and the "double-D  " symbol are registered trademarks of Dolby Laboratories.

Copyright 1992-1997 Dolby Laboratories, Inc. All rights reserved.

Watching TV



POWER



POWER



1

To turn on the TV, press the [POWER] button in the front part of the set or the [Power] button on the remote control.

CH/SELECT



CH/SELECT

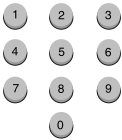

2

Selecting the Channel.

Press the channel [▲, ▼] button or [Number] button to select the desired channel. If input status is set to AV or DVD, press the [INPUT] button to select TV.



3

Adjusting the Volume.

Press the [◀VOL] button to decrease the volume level or [VOL ▶] button to increase the volume level.

POWER



4

To turn off the TV, press the [POWER] button on the remote control.

If power switch of remote control is off, standby LED becomes RED.

To Display the Setting Screen



1

Press the [TV MENU] button in TV mode.

TV setting menu is displayed.

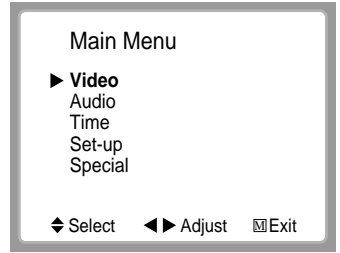

2

Press the [▲, ▼] button to select the desired item.

Current settings and variable settings for the desired item are displayed in the screen.

- Video
- Audio
- Time
- Set-up
- Special



3

Press the [◀, ▶] button and press the [▲, ▼] button to set the desired item, then press the [◀, ▶] button.

Additional steps may be required as items.



4

Press the [TV MENU] button to exit the current setting menu.

Setting Video



1 Press the [▲, ▼] button in TV setting screen to select "VIDEO" and press the [◀, ▶] button.

Setting menu is displayed.

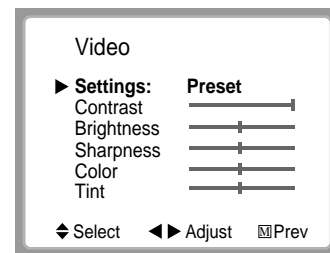

2 Press the [▲, ▼] button to select the desired item, then press the [◀, ▶] button to adjust the desired item.

Current settings and variable settings for the desired item are displayed in the screen.

- **CONTRAST:** Adjust brightness and darkness among objects and background in the screen.
- **BRIGHTNESS:** Adjust the picture until correct brightness is obtained.
- **SHARPNESS:** Adjust outlines of objects on screen to be smooth and clear.
- **COLOR:** Adjust color to display natural human's face colors.
- **TINT:** TINT adjustment is displayed if you receive NTSC through DVD play or AV input.

SETTINGS : You can select the CUSTOM or PRESET. Custom is video setting to adjust desired video and preset is basic video setting.



3 Press the [▲, ▼] button to select other video item, then press the [◀, ▶] button to adjust the desired item.



4 Press the [TV MENU] button after setting is completed.

Setting Audio



1 Press the [**▲**, **▼**] button in TV setting screen to select "Audio", then press the [**◀**, **▶**] button.

Setting menu is displayed.

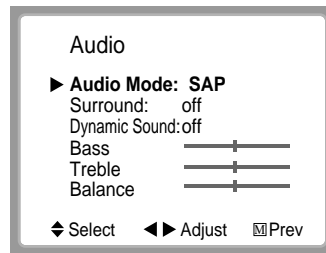

2 Press the [**▲**, **▼**] button to select the desired item, then press the [**◀**, **▶**] button to set the desired item.

Current settings and variable settings for the desired item are displayed on the screen.

- AUDIO MODE : You can select from SAP, MONO, STEREO.
- SURROUND
- DYNAMIC SOUND
- BASS : Low-pitched sound
- TREBLE : High-pitched sound
- BALANCE



3 Press the [TV MENU] button after setting is completed.

NOTE

- If you play DVD, Audio Mode is not displayed

Example

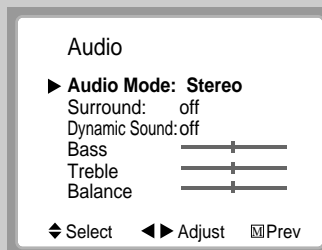

Setting Time



- 1 Press the [**▲**, **▼**] button in the TV setting screen to select "TIME" and press the [**◀**, **▶**] button.

Setting menu is displayed.

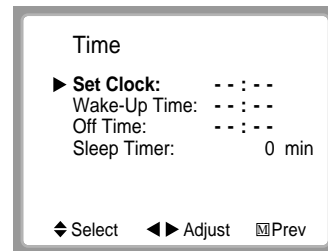

- 2 Press the [**▲**, **▼**] button to select the desired item and press the [**◀**, **▶**] button to set the item.

Current settings and variable settings for the desired item are displayed in the screen.

- SET CLOCK
- WAKE-UP TIME : TV is turned on automatically at the desired time.
- OFF TIME : TV is turned off automatically at the desired time.
- SLEEP TIMER : TV is turned off automatically at the desired time from 15mins. to 120mins.



- 3 Press the [TV MENU] button after setting is completed.

Setting Set up



- 1 Press the [**▲**, **▼**] button in TV setting screen to select "SET UP" and press the [**◀**, **▶**] button.

Setting menu is displayed.

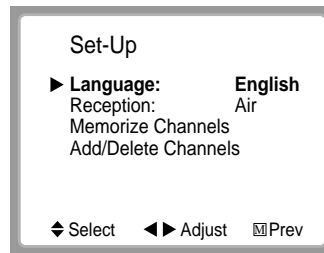

- 2 Press the [**▲**, **▼**] button to select the desired item, then press the [**◀**, **▶**] button to set the desired item.

Current settings and variable settings for the desired item are displayed on the screen.

- LANGUAGE : You can select on-screen language (ENGLISH, SPANISH, FRENCH)
- RECEPTION : You can select air or cable.
- MEMORIZE CHANNELS
- ADD/DELETE CHANNELS



- 3 Press the [TV MENU] button after setting is completed.

Setting Special



1 Press the [**▲**, **▼**] button in the TV setting screen to select "SPECIAL", then press the [**◀**, **▶**] button.

Setting menu is displayed.

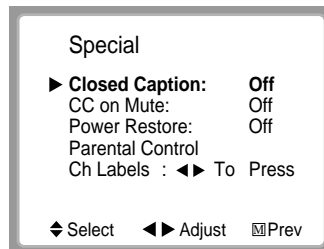

2 Press the [**▲**, **▼**] button to select the desired item, then press the [**◀**, **▶**] button to set the desired item.

Current settings and variable settings for the desired item are displayed on the screen.

- **CLOSED CAPTION** : You can hide words (caption or text) displayed on your TV/DVD screen.
C1, C2 is caption, T1, T2 is text
- **CC ON MUTE** : You can select the caption display on MUTE.
- **POWER RESTORE** : If user have a cable box with AC outlet, then user can connect the TV power cord to the AC outlet and control the TV without TV remote control.
- **PARENTAL CONTROL** : Parents set standard for the program which their children is going to watch
- **CH LABELS** : You can memorize the channel names.



3 Press the [**TV MENU**] button after setting is completed.

N O T E

- If you play DVD, CH label is not displayed.

Example

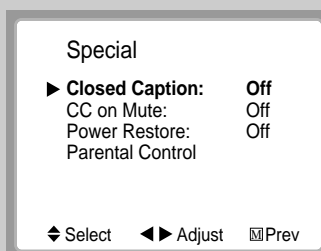

Setting Special (Parental Control Settings)



1

Use the number buttons (0-9) to enter your password, then "Parental Control" menu will be displayed.

If this is the first time you are using your "Parental Control" menu, after entering your password you have to remember it.

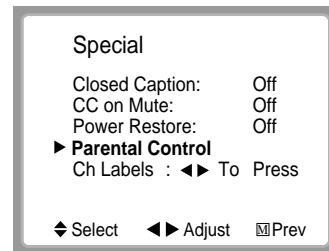

2

Use the [◀, ▶] buttons to select the Parental Control settings you wish to adjust.

Descriptions of the Parental Control settings are on the next page.

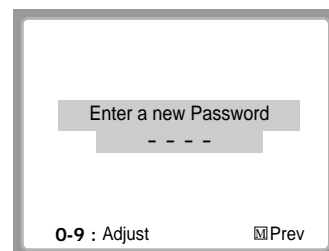

3

The Parental Lock feature will be selected. Use the [◀, ▶] buttons to toggle "On" or "Off".

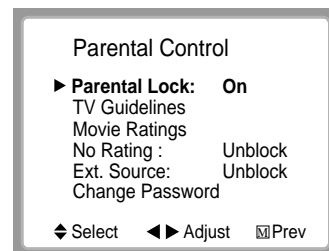

4

Use the [◀, ▶] buttons to adjust the Parental Control settings.

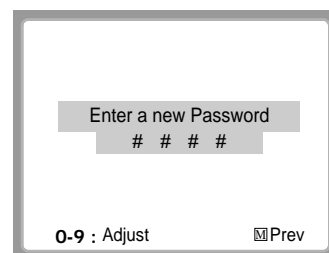

5

Press the [TV MENU] button after setting is completed.

Setting Special (Description of Parental Control Settings)



1

The TV Guidelines set the standard for TV programs excluding sports and news. Use the [▲, ▼] buttons to select, [◀, ▶] buttons to adjust. You can set individual settings with [◀, ▶] buttons.

Parental Control

Parental Lock: On

▶ **TV Guidelines**

Movie Ratings

No Rating : Unblock

Ext. Source: Unblock

Change Password

◆ Select ◀▶ Adjust ▢ Prev

Rating	All	FV	D	L	S	V
TV-MA						
TV-14						
TV-PG						
TV-G						
TV-Y7						
TV-Y						(✓: Block)

◆ Select ◀▶ Adjust ▢ Prev



2

The Movie Ratings set the standard for movie, video, and other media excluding TV programs. Use the [▲, ▼] buttons to select, [◀, ▶] buttons to adjust.

Parental Control

Parental Lock: Off

TV Guidelines

▶ **Movie Ratings**

No Rating : Unblock

Ext. Source: Unblock

Change Password

◆ Select ◀▶ Adjust ▢ Prev

X		
NC-17		
R		
PG-13		
PG		
G		
NR		(✓: Block)

◆ Select ◀▶ Adjust ▢ Prev

Setting Special (Description of Parental Control Settings)



3

The No Rating item toggles between "Unblock" and "Block".

This item determines whether to block or not the programs which are not rated by "Movie Ratings" and "TV Guidelines".

Use [▲, ▼] buttons to change the settings.

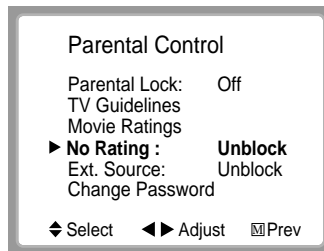

4

The Set Password item let you change the password for entering Parental Control item.

You had better change the initial password "0000". Use [◀, ▶] buttons to enter the password input display, and use the number buttons(0-9) to enter new password.

After you entered the new password, confirmation display will appear. Type again the password.

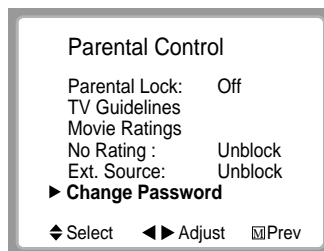

Playing the DVD Video Disc

Basic Playback

- ◆ When you want to enjoy the sound of DVD video discs or audio CDs from the audio system, turn on the audio system and select the input source connected to the TV/DVD.
- ◆ If you do not have the necessary equipment to enjoy Dolby Digital sound, set the Digital Audio Output via the SETUP menu to "PCM (Pulse Code Modulation)".



OPEN/CLOSE



PLAY

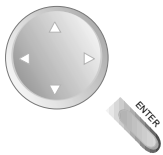

STOP



OPEN/CLOSE



1 Press the [POWER] button on the front part of the set or press the POWER button on the remote control, then the TV/DVD turns on.

2 Press the [OPEN/CLOSE] button to open disc tray.
Place a disc on the disc tray with the playback side down.

3 Press the [PLAY ►] button.
Disc tray is closed automatically and play begins.
DISC indicator is displayed on the TV screen.

4 In the menu screen displayed on the screen.
Press the [▲, ▼, ◀, ▶] button to select the desired item, then press the [ENTER] button or the relevant number directly.
The selected item is played.

5 Press the [STOP ■] button to stop play.
Press the [||] button to pause play.
Press the [OPEN/CLOSE] button to remove the loaded disc.

NOTE

- Do not move the TV/DVD during play. Doing so may damage the disc and TV/DVD.
- Use the [OPEN/CLOSE] button on the remote control or TV/DVD to open and close the disc tray. Do not push the disc tray while it is moving. Doing so may cause TV/DVD to malfunction.
- Do not push up the disc tray or put any objects other than discs on the disc tray. Doing so may cause the TV/DVD to malfunction.
- Be careful of the disc tray not to bite your finger as it is closing. Especially, be careful as it will seriously hurt children.
- When Ⓞ appears on the TV screen while a button is pressed, it means that this function is not available on the disc you are playing.
- Depending on the DVD disc, some operations may be different or restricted. Refer to the instructions of the disc you are playing.

Special Play



RESUME Play

When play is stopped, the unit records the point where the [STOP ■] button was pressed. Press the [Play ►] button and play will resume from this point.

NOTE

- Resume function will be cleared when the [STOP] button is pressed in the STOP mode.
- Resume function will not work if you turn off the TV/DVD and turn on the TV/DVD again.
- Resume function will not work when the disc tray is opened.
- The Resume function may not be available with some DVD discs.



PAUSE (Still picture)

Press the [PAUSE/STEP ||] button during play.

The TV/DVD will be placed in the still picture mode.

* If CD disc is loaded, the TV/DVD will be placed in the pause mode. (Be attention as loading takes long time.)



Step by Step screen

{DVD (Digital Versatile Disc)/ VCD (Video Compact Disc)}

Press the [PAUSE/STEP ||] button during the screen pauses.

Each time you press the [PAUSE/STEP ||] button, the picture advances one scene.

* To resume normal play, press the [PLAY] button.



SKIP FORWARD

Press the [SKIP+ ►►] button during play.

It skips forward by one unit(chapter or track) whenever the button is pressed.



SKIP BACK

Press the [SKIP- ◀◀] button during play.

When the button is pressed during playback a unit(chapter or track), it returns to the start of the unit. When it is pressed again, it skips back whenever the button is pressed.

- ✓ If you press the [SKIP+ ►►] button or [SKIP- ◀◀] button when Tuning Play menu of VCD2.0 is displayed, sometimes menu screen may be displayed again.



■ Search Forward

Press the [F.F/STEP ►►] button during playback. Each time the button is pressed, you can search the picture forward (at Play →►► x2 →►► x4 →►► x16 →►► x100 →► ... speed)



■ Search Back

Press the [F.R/STEP ◀◀] button during playback. Each time the button is pressed, you can search the picture back (at Play →◀◀ x2 →◀◀ x4 →◀◀ x16 →◀◀ x100 →◀ ... speed)



■ Forward Playback in Slow-Motion {DVD/VCD}

Press the [F.F/STEP ►►] button during the paused mode. Each time the button is pressed, you can play the screen in slow-motion (at Pause →►► x1/16 →►► x1/8 →►► x1/4 →►► x1/2 →►► ... speed)



■ Reverse Playback in Slow-Motion {DVD/VCD}

Press the [F.R/STEP ◀◀] button during the paused mode. Each time the button is pressed, you can play the screen in slow-motion (at Pause →◀◀ x1/16 →◀◀ x1/8 →◀◀ x1/4 →◀◀ x1/2 →◀◀ ... speed)

NOTE

- The sound is muted during slow-motion play or search scene. But, the speed sound is audible during searching an Audio CD forward/back.
- Search speed increases up to 3 steps for VCD. (x2, x4, x8)
- Search speed of Audio CD can be increased only up to x2.
- Subtitles do not appear on the screen during slow-motion play.
- Slow-motion play increases up to 3 steps for VCD. (x1/4, x1/8, x1/16)
- Reverse playback in slow-motion is not available for VCD.
- Slow-motion play is not available for Audio CD.

SCREEN SAVER

The Screen saver is useful for preventing your display from becoming damaged. The screen saver picture appears when you leave the TV/DVD in stop mode for about 3 minutes.

To Display GUI Menu

This unit features GUI(Graphic User Interface) Menu showing disc information (title /chapter /track number, elapsed playing time, audio/subtitle language, angle, and sound) and TV/DVD information (repeat play, play mode, marker, etc.) Some icons only show the indicated information. Other icons allow the settings to be changed.

DISPLAY



1

Press the [DISPLAY] button during playback.

Title function can be accessed from the stop mode.

CH/SELECT



CH/SELECT

2

Press the [▲, ▼] button to select the desired item.

The current selected item is indicated in yellow on its GUI menu.

(DVD GUI)		
	1	It shows the current title number. Jump to the desired title number by pressing the [◀, ▶] button or the [NUMBER] button, then press the [ENTER] button.
	1	It shows the current chapter number. Jump to the desired chapter number by pressing the [◀, ▶] button or the [NUMBER] button, then press the [ENTER] button. * You can move at once by pressing the [SKIP+] button or [SKIP-] button.
	0:16:57	It shows the elapsed time. Press the [NUMBER] button to set time, select directly scenes by the desired time, then press the [ENTER] button.
	1 ENG D D 6 CH	It shows the current audio soundtrack language, encoding method, and channel number. Press the [◀, ▶] button or [DVD AUDIO] button to change the settings.
	OFF	It shows the current subtitle language. Press the [◀, ▶] button or [SUB-TITLE] button to change the setting.
	1	It shows the current angle number. Press the [◀, ▶] button or [ANGLE] button to change the angle.
	NORM.	It shows the current sound. Press the [3D] button to change the setting. Press the [◀, ▶] button to change the setting.

To Display GUI Menu



It shows the current track number. Jump to the desired track number by pressing the [◀, ▶] button or the [NUMBER] button, then press the [ENTER] button.

* You can move at once by pressing the [SKIP-F] button or [SKIP-B] button.

It shows the elapsed time.

It shows the current audio (STEREO, LEFT, RIGHT). Press the [◀, ▶] button or [DVD AUDIO] button to change the desired audio channel.

It shows the current sound. Press the [3D] button to change the setting.



3 Press the [◀, ▶] button to select the desired setting.

- When numbers such as title number are displayed, the [NUMBER] button can also be used for setting instead of the [◀, ▶] button.
- For some functions, the setting will be registered immediately; for others, the [ENTER] button must be pressed.



4 To clear the GUI Menu Icons, press the [DISPLAY] button again.

NOTE

- Some of the above GUI menu may not work on certain DVD discs.
- Track icon is not displayed in VCD 2.0.
- Examples of GUI Menu Icons (The screens may differ depending on the disc contents)

(GUI in VCD 2.0)



(GUI in REPEAT PLAY mode)

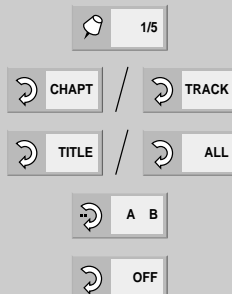

Playing the Desired Scene or Track during Play

Directly Moving to the Desired Title

Some movie discs may contain multiple titles. If the disc has a movie title menu recorded on it, the [TITLE] button can be used to select the movie title. Details of operation may differ depending on the disc used.

* Selecting a title may not be available on certain DVD discs.



1

Press the [TITLE] button.

A list of the titles on the disc is displayed. Pressing the [TITLE] button again to resume play from the scene when the [TITLE] button was first pressed.



2

Press the [ENTER] button or [PLAY] button after pressing the [▲, ▼, ◀, ▶] button to select the desired title.

The selected title now starts playing.



NOTE

- In the case of DVD discs not containing multiple titles DVD title menu is displayed on the screen when the [TITLE] button is pressed.

Playing the Disc, Chapter, Title and Track Repeatedly

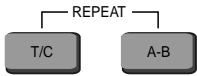

Press the [T/C] button during play.

Each time this button is pressed, the TV screen changes and the disc will repeat the chapter, title or track.

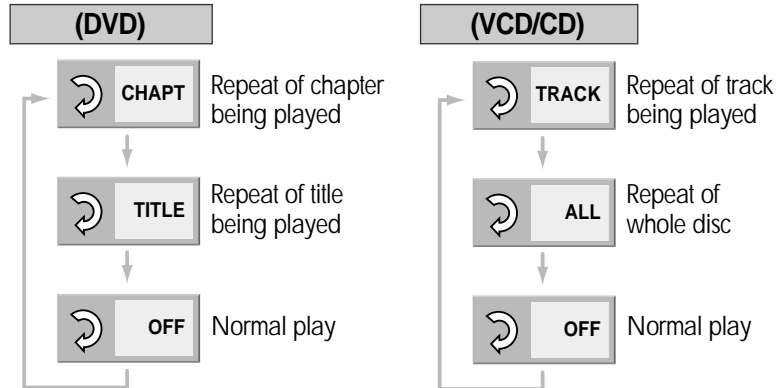

- * If the [REPEAT] button is pressed during program play, repeat play is operated: "Repeat of the current programmed track" --> "Repeat of all programs" --> "Program play".
- * To return to normal play, press the [T/C] button until "OFF" is displayed.

Repeating the Given Sections



1 Press the [A-B] button where you want to Play repeatedly.

- * It directly converts to "OFF" mode when you press the [CLEAR] button.



2 Press the [A-B] button where you want to end repeat play.

Repeat play of the selection between points A and B starts.

- * To return to normal play, press the [A-B] button until "OFF" is displayed.



NOTE

- Repeat play is available only with discs for which the elapsed playing time appears during play.
- Repeat play may not work properly on some DVDs.
- A-B repeat play is available only within a title or a track.
- Some subtitles around point A or B may fail to appear according to DVD type.

Searching by Memorizing the Favorite Scene

You can play the favorite scenes as if you mark the favorite pages of a book.

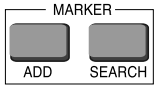

1

Press the [ADD] button on the scene to be viewed(listened) again.



Indication of "1/5" is stored in the memory. Up to 5 scenes can be stored in the memory.

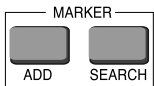

2

Press the [SEARCH] button during play.

The stored scenes and current scene are displayed in the screen.

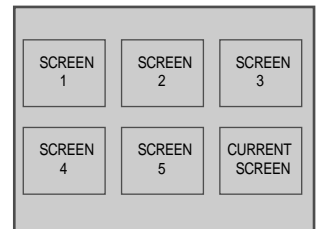

3

Press the [▲, ▼, ◀, ▶] button to select the scene, then press the [ENTER] button to play the selected scene.

Play starts from the selected scene.

* To clear the selected scene, press the [CLEAR] button. The current scene may not be cleared.

NOTE

- Some subtitles recorded around the marked scenes may fail to appear on certain DVD discs.
- All the marked scenes are cleared when the power is turned off or the disc is removed.
- The marked scenes are not stored when the DVD or title menu is displayed on the TV screen.

Displaying menus in disc

Displaying menus in disc

Some DVD discs have single menu structures called DVD menus. For example, DVDs programmed with complex contents provide guide menus, and those recorded with various languages provide menus for audio menu and subtitle language.

* The contents of DVD menu and operation differ from disc to disc.



1 Press the [MENU/PBC] button during play.

The DVD menu available on the disc is now displayed.

By pressing the [MENU/PBC] button again resumes play from the scene where the [MENU/PBC] button was first pressed.



Example of DVD menu



2 Press the [ENTER] button or the [NUMBER] button(s) after pressing the [▲, ▼, ◀, ▶] button to select desired item.

The selected item is now displayed.



Storing Viewed DVD Settings

Storing Viewed DVD Settings

This function allows you to store viewed DVD settings. Even though you remove a disc or turn off the [POWER] button, the settings are still stored. If you place the viewed DVD in the disc tray again, "Resume disc from last position?" message is displayed on the screen. If you play the DVD, the stored settings are automatically called.

1 Place the viewed DVD.

TV screen is displayed as follows.
But, if you do not press any button within 10 seconds, the DVD player is automatically played.

Resume disc from last position?

1. No 2. Yes



2 Press the [◀, ▶] button to select "2. Yes" and press the [ENTER] button.

The stored settings are automatically called and the player resumes disc play from last play position.



NOTE

- The TV/DVD can store the following 6 settings.
 - Last viewed scene (Resume function)
 - TV Aspect
 - Disc Audio language
 - Disc Subtitle language
 - Disc Menu language
 - Camera
- Every setting is stored.
- Only the DVD setting can be stored.
- If you remove a disc or press the [POWER] button to turn off the power when the DVD or title menu is displayed on the TV, settings are not stored.

Changing Subtitle Language

Changing Subtitle Language

In the SETUP screen, you can select the initial subtitle language and change to other language. This function works only if the subtitle languages are recorded in multiple languages.

SUB-TITLE



1

Press the [SUB-TITLE] button during play.

If there is no subtitle, "OFF" or "⊗" instead of language is displayed.



SUB-TITLE



2

Press the [SUB-TITLE] button repeatedly until the desired language is selected.

* To clear an on-screen subtitle, press the [SUB-TITLE] button repeatedly and select "OFF".



NOTE

- Subtitle language may not be converted into the selected language immediately.
- When you play a disc with caption function, subtitle and caption title can be overlapped in the TV screen of caption mode. In this case, turn off the caption function or turn off the caption of TV set.

Changing Audio Language

Changing Audio Language

In the SETUP screen, you can select the initial audio language and change to other language. This function works only if the subtitle languages are recorded in multiple languages.

DVD AUDIO



1 Press the [DVD AUDIO] button during play.



- DVD -



- VCD/CD -

DVD AUDIO



2 Press the [DVD AUDIO] button repeatedly until the desired language is selected.



- DVD -



- VCD/CD -

NOTE

- If the desired language is not selected by pressing the button several times, it means the language is not available.
- When the power is turned off or disc is removed, the subtitle is displayed in a language of the SETUP menu. Language in the disc is displayed if this language is not recorded in the disc.
- Some discs may not be changed by pressing the [DVD AUDIO] button.

Using Zoom Feature



Using Zoom Feature

The Zoom feature allows you to enlarge the Picture image 4 times or 16 times.



1

Press the **[ZOOM]** button during play or pause.

The region to zoom in the centre of the screen is displayed.

- Whenever you press the **[ZOOM]** button, the TV screen is changed as shown on the right. Zoom magnification is displayed in the right top of zoom region.
- If you want to change the zoom region, press the **[▲, ▼, ◀, ▶]** button.



2

Press the **[ENTER]** button.

The selected screen is displayed as full screen.



3

To resume normal screen,

Press the **[ZOOM]** button again to release the Zoom feature, play or pause screen is displayed.

N O T E

- Some discs may not respond to the Zoom feature.
- The Zoom Feature is not available with subtitles or menus included on DVD video discs.

Viewing from Another Angle Producing a 3D SURROUND Effect

Viewing a Scene from Another Angle

Some DVDs may contain scenes which have been shot simultaneously from a number of different angles. For these discs, the same scene can be viewed from each of these different angles using the [ANGLE] button.

* The recorded angles differ depending on the disc used.



1

Press the [ANGLE] button during play.



2

Press the [ANGLE] button repeatedly until the desired angle is selected.



NOTE

- This function only works for discs having scenes recorded at different angles.

Producing a 3D SURROUND Effect

This unit can produce a 3D Surround effect, using 3D Surround Sound technology, which simulates multi-channel audio play from two conventional stereo speakers instead of five or more speakers required to listen to multi-channel audio at home theatre. This feature works with DVD discs encoded with Dolby Pro Logic and Dolby Digital audio tracks.



1

Press the [3D] button during play.



2

Press the [3D] button repeatedly until the desired sound is selected.



NOTE

- This 3D Surround effect may not be available in some DVD discs recorded with a mono audio soundtrack.
- Turn off the TV surround sound and other surround effects when using this 3D surround effect.
- For the best 3D Surround effect using only two speakers, it is recommended that the two speakers be positioned approximately 183cm to 244cm apart, and the listening position should be 183cm to 244cm away from the speakers.

Random Play

You can play titles or tracks in random order (VCD, CD).



1 Press the [RANDOM] button during stop mode.

TV/DVD automatically begins Random Play.

If you press the [RANDOM] button during Normal Play, the TV/DVD selects other titles (or tracks) randomly and begins to play.



2 To return to normal play, press the [RANDOM] button during random play.

N O T E

- **Notice: This function is only available with music CD, video CD disc. Random play does not work properly with DVD movie discs.**
- Random play may not be available with certain discs.
- If you press the [SKIP+ ►►] or [SKIP- ◄◄] button during random play, the TV/DVD goes to another track randomly and starts play.

Program Play

The TV/DVD plays the tracks on the disc in the order you specify.



1 Press the [PROGRAM] button in the play or stop mode.

The program play screen appears on the TV screen.

* To exit the screen, press the [PROGRAM] button.

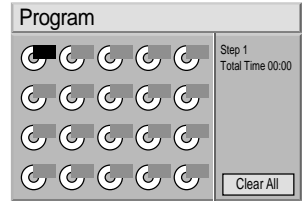

2 Press the [▲, ▼, ◀, ▶] button and press the [NUMBER] button to select the desired track number.

Up to 20 tracks can be programmed.

Clearing the program...

- To clear the programmed tracks one by one
Press the [▲, ▼, ◀, ▶] button to select the unwanted number, then press the [CLEAR] button.
 - To clear all the programmed tracks
Press the [▲, ▼, ◀, ▶] button to select "Clear All", then press the [ENTER] button. Press the [Play] or [ENTER] button to exit the screen.
- N.B.** The programs are not cleared when the [PROGRAM] button is pressed to exit the screen. (The programs are also cleared when the power is turned off or the disc is removed.)

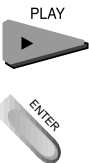
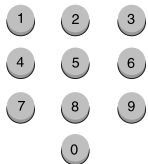
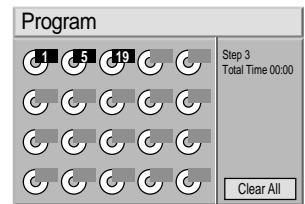

3 Press the [PLAY] or [ENTER] button.

The selected tracks are stored in player's memory and play begins with the first one programmed.

N.B. If the [PROGRAM] button is pressed to exit the screen, the selected tracks are not stored in the memory.

* After playing all tracks programmed, play is stopped.

NOTE

- Notice: Program play function is available only with music CD/video CDs. It does not work with DVD movie discs and video CD (version 2.0).

Playing an MP3 Disc



Playing an MP3 File

1 Place the an MP3 disc in the machine.

The MP3 menu is displayed.

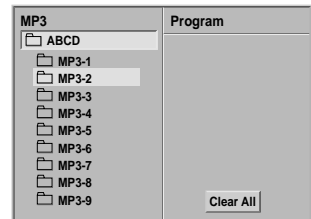

2 Press the [▲, ▼] button to select a directory containing the desired MP3 file, then press the [ENTER] button.

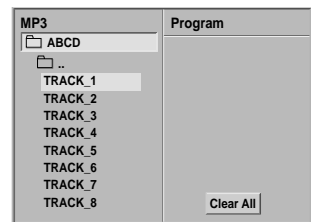

3 Select the desired MP3 file in the selected directory by pressing the [▲, ▼] button.

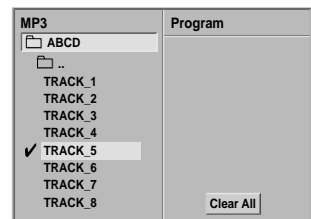

4 Press the [ENTER] or [PLAY] button to play a file.

- Press the [SKIP-F] or [SKIP-B] button to play the next file or previous file during playback.
- If you press the [TITLE] button during play, the first page of the current directory is displayed. Then, if you press the [TITLE] button within 5 seconds again, the next page is displayed.
- To move to the initial directory during play, press the [MENU/PBC] button.

NOTE

- The file and directory name are only displayed in English.
- If there is an impossible code to display, (_) is displayed instead of English.
- If there is no MP3 file in a directory, ⓪ is displayed as the directory name.
- This unit can play up to 256 directories or 256 files per disc.
- Disc format is compatible with ISO9660 only.
- Please record MP3 files using the software that can create a FILE SYSTEM. Otherwise, these MP3 files cannot be played.
Ex) If you use Direct-CD creator software, it is recommended that you must use "Easy-CD Creator", which creates an ISO9660 file system.
- If other files instead of MP3 files are already stored on the CD-R/RW disc, do not use that disc. Please use a new disc.



CH/SELECT



CH/SELECT



CH/SELECT



ENTER

Programming an MP3 File

1 Place the an MP3 disc in the machine.
The MP3 menu is displayed.

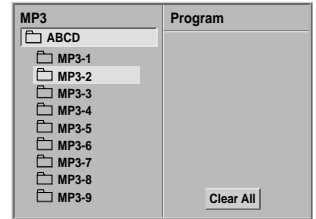

2 Press the [**▲**, **▼**] button to select a directory containing the desired MP3 file, then press the [ENTER] button.

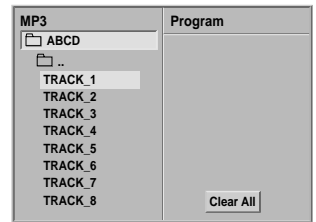

3 Select the desired MP3 file in the selected directory by pressing the [**▲**, **▼**] button.

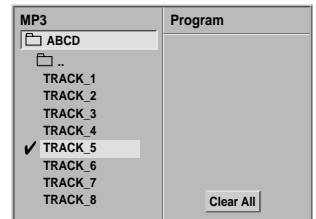

4 Press the [PROGRAM] button to add the selected file to a program list.
Repeat step 3-4 to select another track.
Up to 60 files can be programmed.

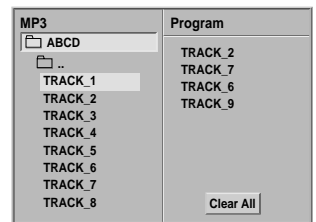

5 Press the [**▶**] button to select the desired MP3 file and press the [ENTER] button or [PLAY] button to begin playback.

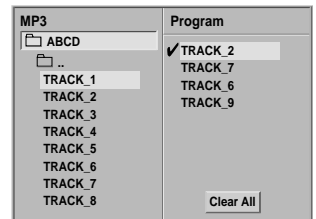

If you want to enter the main menu, press the [**◀**] button.

After playing all tracks, programmed play is stopped.

Playing Repeatedly and Editing the Programmed MP3 File

■ Playing an MP3 file repeatedly

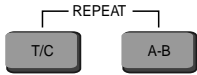

- If you press the [T/C] button once during play, the current MP3 file will play repeatedly.

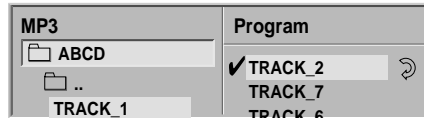

- If you press the [T/C] button twice during play, all Files in program files on the disc will play repeatedly.

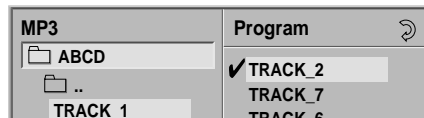

- If you press the [T/C] button three times, repeat play will be cancelled.

■ Clearing MP3 files one by one



CH/SELECT

CLEAR



- Press the [▲, ▼, ◀, ▶] button to select the unwanted MP3 file on the program list, then press the [CLEAR] button.

■ Clearing all the MP3 files in the program list



CH/SELECT



- Press the [▲, ▼, ◀, ▶] button to select the Clear All and press the [ENTER] button.

General Information of Initial Settings

Once the initial settings have been completed, the TV/DVD can always be operated under the same conditions. Especially with DVD discs, the settings will be retained in the memory until they are changed even though the power is off.



1 Press the [SETUP] button in the stop or play mode.

The initial settings menu is displayed.



2 Press the [▲, ▼] button to select the desired item.

The screen will show the current setting for the selected item, and the alternate setting(s).

- Disc Audio (see page 45)
- Disc Subtitle (see page 45)
- Disc Menu (see page 45)
- Rating (see page 47)
- Password (see page 48)
- TV Aspect (see page 49)
- Menu Language (see page 50)
- Digital Audio Output (see page 51)
- Others (see page 52)



3 Press the [▶] button and then the [▲, ▼] button to select the desired setting and press the [ENTER] button.

Some items require additional steps.



4 To exit the current SETUP menu, press the [SETUP] or [PLAY] button.

Selecting disc languages {DVD Only}

In the initial settings, you can select Disc Audio, Disc Subtitle and Disc Menu for all discs to be played.

When you play the DVD video disc including Disc Subtitle, the TV/DVD automatically displays the pre-selected subtitle language.



- 1** In the **SETUP** screen, press the [**▲**, **▼**] button to select **"Disc Audio"** and press the [**▶**].



- 2** Press the [**▲**, **▼**] button to select the desired language and then press the [**ENTER**].

- Original: The original language of each disc will be selected.
- English, French: The English and French will be selected.
- Other: Other languages can be selected. You can input 4-character language code. (Refer to the language codes on the next page. Press the [CLEAR] button if an incorrect language code is entered.)

- 3** The **"Disc Subtitle"** and **"Disc Menu"** are selected by the same method.

N O T E

- If the language selected is not recorded on the disc, the original language designated by each disc will be selected.

Table of Language Codes and Their Abbreviations

Enter the appropriate language code for the initial settings of "Disc Audio", "Disc Subtitle" and/or "Disc Menu".

Code	Language
6565	Afar
6566	Abkhazian
6570	Afrikaans
6577	Ameharic
6582	Arabic
6583	Assamese
6588	Aymara
6590	Azerbaijani
6665	Bashkir
6669	Byelorussian
6671	Bulgarian
6672	Bihari
6678	Bengali, Bangla
6679	Tibetan
6682	Breton
6765	Catalan
6779	Corsican
6783	Czech
6789	Welsh
6865	Danish
6869	German
6890	Bhutani
6976	Greek
6978	English
6979	Esperanto
6983	Spanish
6984	Estonian
6985	Basque
7065	Persian
7073	Finnish
7074	Fiji

Code	Language
7079	Faroese
7082	French
7089	Frisian
7165	Irish
7168	Scots Gaelic
7176	Galician
7178	Guarani
7185	Gujarati
7265	Hausa
7273	Hindi
7282	Croatian
7285	Hungarian
7289	Armenian
7365	Interlingua
7378	Indonesian
7383	Icelandic
7384	Italian
7387	Hebrew
7465	Japanese
7473	Yiddish
7487	Javanese
7565	Georgian
7575	Kazakh
7576	Greenlandic
7577	Cambodian
7578	Kannada
7579	Korean
7583	Kashmiri
7585	Kurdish
7589	Kirghiz
7665	Latin

Code	Language
7678	Lingala
7679	Laothian
7684	Lithuanian
7686	Latvian, Lettish
7771	Malagasy
7773	Maori
7775	Macedonian
7776	Malayalam
7778	Mongolian
7779	Moldavian
7782	Marathi
7783	Malay
7784	Maltese
7789	Burmese
7865	Nauru
7869	Nepali
7876	Dutch
7879	Norwegian
7982	Oriya
8065	Panjabi
8076	Polish
8083	Pashto, Pushto
8084	Portuguese
8185	Quechua
8277	Rhaeto-Romance
8279	Rumanian
8285	Russian
8365	Sanskrit
8368	Sindhi
8372	Serbo-Croatian
8373	Singhalese

Code	Language
8375	Slovak
8376	Slovenian
8377	Samoaan
8378	Shona
8379	Somali
8381	Albanian
8382	Serbian
8385	Sundanese
8386	Swedish
8387	Swahili
8465	Tamil
8469	Telugu
8471	Tajik
8472	Thai
8473	Tigrinya
8475	Turkmen
8476	Tagalog
8479	Tonga
8482	Turkish
8484	Tatar
8487	Twi
8575	Ukrainian
8582	Urdu
8590	Uzbek
8673	Vietnamese
8679	Volapük
8779	Wolof
8872	Xhosa
8979	Yoruba
9072	Chinese
9085	Zulu

Selecting Parental Control Rating Levels {DVD Only}

This is to prohibit playing of DVDs which are unsuitable for children. Some DVDs have the rating restriction function which enables parents to prevent children from playing discs. TV/DVD also include password setting functions to prevent children from changing the level.



1 In the **SETUP** screen, press the [**▲**, **▼**] button to select "Rating" and press the [**▶**] button.

Disc Audio	8
Disc Subtitle	7
Disc Menu	6
Rating	5
Password	4
TV Aspect	3
Menu Language	2
	1
Digital Audio Output	▶ Unlock
Others	



2 Press the [**▲**, **▼**] button to select the desired level and press the [**ENTER**] button.

After this process, you must designate "password". If not, someone can change this settings.

Disc Audio	8 Blocked
Disc Subtitle	7 Blocked
Disc Menu	✓ 6
Rating	5
Password	4
TV Aspect	3
Menu Language	2
	1
Digital Audio Output	Unlock
Others	

NOTE

- You cannot play DVD video discs rated higher than the level you selected unless you release the parental lock. For example, when you select level 7, discs rated higher than level 7 cannot be played. (Higher rated means near to adult movie.)
- If you change the level and enter a password, playing all DVDs with ratings higher than your selection will be locked. If you want to change the rating again, you have to enter the correct password. For example: if you change the level to "5", the TV/DVD will not play discs with ratings of "6", "7", or "8". If you change the level again, you must enter the correct password.

Designating Password {DVD Only}

If you change the rating level to "7" or lower, you must enter a 4-number "password" to prevent playing discs with higher ratings.



1 In the SETUP screen, press the [▲, ▼] button to select "Password" and press the [▶] button.

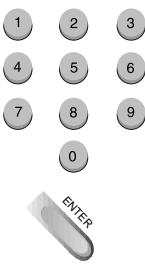
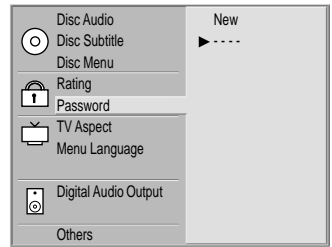

2 Press the [NUMBER] button to input a 4-number password and press the [ENTER] button.

* Do not forget your password.

3 Input the 4-number password again and press the [ENTER] button to verify.

* Setting has been completed.

■ To change/clear memorized password

- 1 In the SETUP screen, press the [▲, ▼] button to select "Password" and press the [▶] button.
- 2 Press the [NUMBER] button to input a 4-number password and press the [ENTER] button.
- 3 To change or clear your password, select the "Change" or "Clear" and press the [ENTER] button.

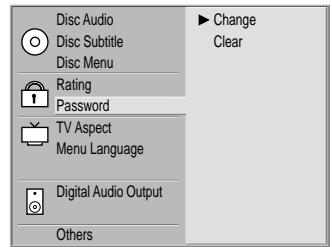

■ If you forget your memorized password,

- 1 In the SETUP screen, press the [▼] button to select "Password".
- 2 Enter 6-digit number "210499" and press the [ENTER] button. The 4-number password is cleared.
- 3 Enter a new password.

Selecting TV Aspect

Select the appropriate screen type according to your TV set: 4:3 or 16:9.



- 1** In the **SETUP** screen, press the [**▲**, **▼**] button to select "TV Aspect" and press the [**▶**] button.

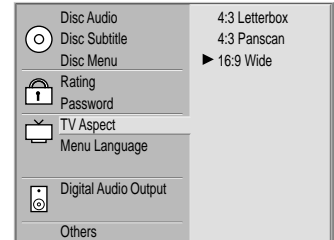

- 2** Press the [**▲**, **▼**] button to select the desired Aspect and press the [**ENTER**] button.

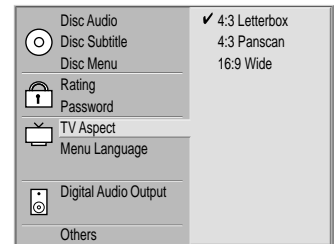

4:3 Letterbox

The video material not formatted in the Pan & Scan style is played in the letterbox style. Black bands appear at top and bottom of screen.

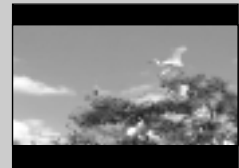

4:3 Panscan

Select when a conventional TV set is connected. The video material formatted in the Pan & Scan style is played in such a style. (For screen formatted in 16:9, then only the centre part of screen can be displayed).



16:9 Wide

Select when a wide-screen TV set is connected. The picture is played in full screen. (The wide-screen TV is also required to be set to "FULL".)



Selecting Menu Language

It is for selecting DVD menu language and the language which displays on the TV.



1 In the **SETUP** screen, press the [**▲**, **▼**] button to select "Menu Language" and press the [**▶**] button.



2 Press the [**▲**, **▼**] button to select the desired language and press the [**ENTER**] button.



Selecting Digital Audio Output

Each DVD disc has a variety of audio output options.



1 In the **SETUP** screen, press the [**▲**, **▼**] button to select “Digital Audio Output” and press the [**▶**] button.

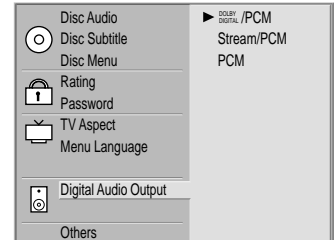

2 Press the [**▲**, **▼**] button to select the desired digital audio output and press the [**ENTER**] button.

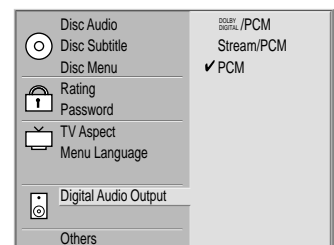

■ DOLBY DIGITAL/PCM

Select “DOLBY DIGITAL/PCM” if a digital output is supplied to a Dolby Digital decoder (or an amp or other equipment with Dolby Digital decoder).

■ Stream/PCM

Select “Stream/PCM” if a digital output is supplied to an amp or other equipment with DTS decoder, Dolby Digital decoder and MPEG decoder.

■ PCM

Select “PCM” if a digital output is supplied to an amp or other equipment with PCM only (or MD recorder or DAT deck).

N O T E

- If a digital audio output signal is supplied to a receiver or other equipment without a corresponding digital decoding capability, a very loud noise may be produced which could permanently damage the speakers.
- The DTS DVD disc sound is played only when the TV/DVD is connected to an amp with a DTS decoder.

Play disc	Output		
	Stream/PCM	Dolby Digital/PCM	PCM only
96kHz Linear PCM DVD	PCM	PCM	PCM
DTS DVD	DTS bit stream	No Output	No Output
Dolby Digital DVD	Dolby Digital bit stream	Dolby Digital bit stream	PCM
MPEG DVD	MPEG bit stream	PCM	PCM
Audio CD/Video CD	PCM	PCM	PCM
DTS Audio CD	DTS bit stream	DTS bit stream	DTS bit stream

Others



1 In the SETUP screen, press the [▲, ▼] button to select "Others" and press the [▶] button.

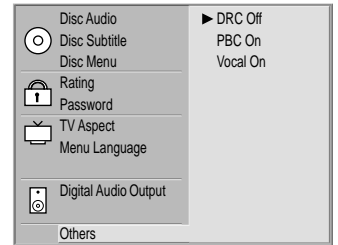

2 Press the [▲, ▼] button to select the desired item and press the [ENTER] button.



■ DRC (Dynamic Range Compression)

What is DRC (Dynamic Range Compression)?

It is also called "Midnight Mode". It can decrease the difference between the loudest and the softest tone and prevent sudden loud tone. Therefore, you can get the soft voice clearly without disturbing others at night.

On: It compresses the dynamic range.

Off: It outputs the dynamic range as it originally was.

■ PBC (PlayBack Control)

On: Menu mode works when playing a disc with PBC function (Video CD version 2.0).

Off: Menu mode does not work when playing a disc with PBC function (Video CD version 2.0).

NOTE



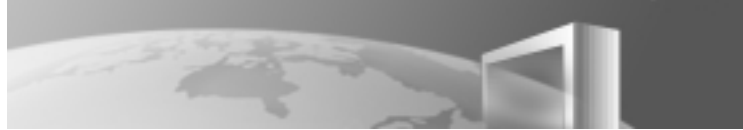

- The DRC function works only during playing the Dolby Digital DVD discs.
- The level of Dynamic Range may differ depending on the DVD disc.

About DVD



Playable Disc

This TV/DVD can play the following discs.

Type	Disc mark	Contents	Disc size	Maximum playback time
DVD video discs		Audio+Video	12cm	Approx. 4 hours (single sided disc)
				Approx. 8 hours (double sided disc)
			8cm	Approx. 80 minutes (single sided disc)
				Approx. 160 minutes (double sided disc)
video CDs		Audio+Video	12cm	Approx. 74 minutes
			8cm	Approx. 20 minutes
Music CDs		Audio	12cm	Approx. 74 minutes
			8cm	Approx. 20 minutes
MP3		Audio	12cm	Approx. 160 minutes

In addition, this unit can play back a CD-R and CD-RW disc. You cannot play back discs other than those listed above (CD-ROM, CD-EXTRA, CD-G, photo CD, and CD-i discs cannot be played on this TV/DVD.)

This TV/DVD is manufactured to adopt the NTSC colour broadcasting system in operation.

Region Number

TV/DVD and DVD discs are marked for the Region number to be played in the relevant country. Only if the Region number described on the DVD disc corresponds to the Region number of this TV/DVD, this TV/DVD can play that disc. The Region number of this TV/DVD is 1. Please use only discs whose Region number is 1 or is not limited to the Regional Restriction (ALL). Otherwise, this TV/DVD does not work.



(Region Number 1)



(No Regional Restriction)

Notes on Copyright

This product incorporates copyright protection technology that is protected by Macrovision Corporation and other rights owners. Use of this copyright protection technology must be authorized by Macrovision Corporation and technological interpretation or disassembly is prohibited.

Discs

Always...

- handle your discs with care.
Hold a disc with fingers on the border or hole,

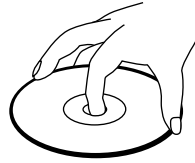

- place disc with the label facing upward (in case of a single-sided disc),
- place the disc properly into the tray using the proper guide area,
- use a soft cloth to clean discs if necessary, wipe from the centre to the border,
- always put discs back into their cases after playing and store in a vertical position.

Never...

- never close the tray with two discs on it or with a disc slipping out of the guide area,
- never play cracked, chipped or deformed discs nor try to repair them with adhesive tape or glue,
- never write on the disc,
- never move the player during playback,
- never scratch discs or store them in places of direct sunlight, high humidity or high temperature,
- never try to play a Photo CD , CD-G or CD-i in this TV/DVD.
- never use record cleaning sprays, benzine, static electricity liquids or any other solvent, if the disc surface is dirty.
- Wipe gently with a soft damp (water only) cloth, never wipe the disc in a circular motion, since circular scratches are likely to occur and could cause noise during playback.

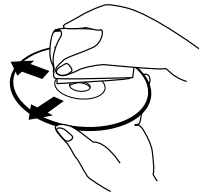

If you hear strange noises or vibrations coming out of the unit once a disc has started to play, rapidly press the STOP button of the remote control or front of player.

Before Calling Service Personnel

Symptoms	Correction
<ul style="list-style-type: none"> • Colour is not displayed and net pattern is displayed on the specific channel. 	<ul style="list-style-type: none"> ➤ Check the external antenna and cable TV conditions. ➤ Check whether you select the correct channel.
<ul style="list-style-type: none"> • Vertical and horizontal line and net pattern are displayed on the screen in a moment. Vibration is also displayed. 	<ul style="list-style-type: none"> ➤ Check the interference wave caused by car, neon sign, and high frequency. ➤ Check the strong interference radio wave from wave of other devices or radio station. Please stop the use of mobile phone, hair dryer, and electric drill.
<ul style="list-style-type: none"> • Pictures are overlapped and white and black spots are displayed 	<ul style="list-style-type: none"> ➤ Check damage of antenna or connection of antenna cable. ➤ Check the height and direction of antenna. If it is incorrect, please adjust the antenna.
<ul style="list-style-type: none"> • The original colours are not displayed in a screen in specific areas. 	<ul style="list-style-type: none"> ➤ Remove from magnetic fields or rotate set until purity error disappears.
<ul style="list-style-type: none"> • Picture is displayed irregularly. 	<ul style="list-style-type: none"> ➤ Check the connection of antenna cable (incorrect connection or disconnection). ➤ Move this product to another location.
<ul style="list-style-type: none"> • No picture and sound 	<ul style="list-style-type: none"> ➤ Plug the power cord into the wall outlet securely. ➤ Press the [TV/AV/DVD] button to change input mode.
<ul style="list-style-type: none"> • No sound 	<ul style="list-style-type: none"> ➤ [MUTE] button may be pressed. ➤ Check the volume.
<ul style="list-style-type: none"> • The remote control does not work properly 	<ul style="list-style-type: none"> ➤ Check a stoppage of power supply ➤ Check whether the power cord is plugged into the wall outlet. ➤ The batteries in remote control may be exhausted or loaded in wrong polarity. ➤ Check whether the remote control is too far from the player and is not pointed at the remote sensor of the player.
<ul style="list-style-type: none"> • The playback picture is poor 	<ul style="list-style-type: none"> ➤ Check the contamination of a disc and clean the disc.
<ul style="list-style-type: none"> • The DVD player does not start playback 	<ul style="list-style-type: none"> ➤ Insert a disc. ➤ Insert a playable disc. Check the disc type, colour system and Region code. ➤ Place the disc with the playback side down. ➤ Place the disc on the disc tray correctly inside the guide. ➤ Check the contamination of a disc and clean the disc. ➤ Press the [MENU] button to turn off the menu screen. ➤ Cancel the Rating function or change the rating level.

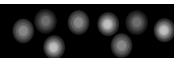

Warranty

Daewoo Electronics Corporation of America warrants each new electronic product manufactured by it to be free from defective material and workmanship and agrees to remedy any such defect or to furnish a new part (at the Company's option) in exchange for any part of any unit of its manufacture which under normal installation, use, and service disclosed such defect, provided the unit is delivered by the owner to us or to our authorized distributor from whom purchased or authorized service station, intact, for our examination with all transportation charges prepaid to our factory. To establish and receive warranty service at our factory or authorized service facilities, proof of purchase/dated sales invoice is required

Return authorization must be obtained before any merchandise is returned to the factory.

This warranty does not extend to any of our electronic products which have been subjected to misuse, neglect, accident, incorrect wiring not our own, improper installation, unauthorized modification, or to use in violation of instructions furnished by us, nor units which have been repaired or altered outside of our factory, nor to cases where the serial number thereof has been removed, defaced, or changed.

This warranty is in lieu of all warranties expressed or implied and no representative or person is authorized to assume for us any other liability in connection with the sale of our electronic products.

Over-the-counter exchange for units that are initially defective
"Initially defective" is described as when the dealer opens the unit and finds that it is inoperative or a customer opens a new unit and finds that it is inoperative. This unit may be returned to the factory by the dealer for exchange. Under no circumstances will the customer be permitted to return the defective unit directly to the factory.
Exchange must be directly with the dealer.

Model	Parts	Labor	Picture Tube
DDQ-20L6SC	1 year	1 year	2 years



This instrument is listed by Underwriter's Laboratories, Inc. It is designed and manufactured to meet rigid U.L. safety standards against X-radiation, fire, casualty and electrical hazards.



As an **ENERGY STAR**[®] Partner DAEWOO Electronics has determined that this product or product model meets the **ENERGY STAR**[®] guidelines for energy efficiency.



Daewoo Electronics Corporation of America

120 Chubb Avenue
Lyndhurst, NJ 07071

For more information about this or other Daewoo products, please call 1-800-DAEWOO8.

P/N : 48586090E101-R0

Free Manuals Download Website

<http://myh66.com>

<http://usermanuals.us>

<http://www.somanuals.com>

<http://www.4manuals.cc>

<http://www.manual-lib.com>

<http://www.404manual.com>

<http://www.luxmanual.com>

<http://aubethermostatmanual.com>

Golf course search by state

<http://golfingnear.com>

Email search by domain

<http://emailbydomain.com>

Auto manuals search

<http://auto.somanuals.com>

TV manuals search

<http://tv.somanuals.com>