

DAEWOO

TV / DVD COMBO

OWNER'S MANUAL

Model:

• DDT-21H9 S

HELP LINE NUMBER:
011 89 2525 77



DAEWOO

IMPORTANT SAFEGUARDS

IMPORTANT SAFEGUARDS

- 1 **Read Instructions** - All the safety and operating instructions should be read before the appliance is operated.
- 2 **Retain Instructions** - The safety and operating instructions should be retained for future reference.
- 3 **Heed Warnings** - All warnings on the appliance and in the operating instructions should be adhered to.
- 4 **Follow Instructions** - All operating and use instructions should be followed.
- 5 **Cleaning** - Unplug TV/DVD from the wall outlet before cleaning. Do not use liquid cleaners or aerosol cleaners. Use a damp cloth for cleaning.
- 6 **Attachments** - Do not use attachments not recommended by the TV/DVD manufacturer as they may cause hazards.
- 7 **Water and Moisture** - The apparatus shall not be exposed to dripping or splashing water and that no object filled with liquids, such as vases, shall be placed on the apparatus.
- 8 **Accessories** - Do not place this TV/DVD on an unstable cabinet, stand, bracket, or table. The TV/DVD may fall, causing serious injury to someone, and serious damage to the appliance. Use only with a cabinet, stand, bracket, or table recommended by the manufacturer, or sold with the TV/DVD. Any mounting of the appliance should follow the manufacturer's instructions and use a mounting accessory recommended by the manufacturer. An appliance and cart combination should be moved with care. Quick stops, excessive force, and uneven surfaces may cause the appliance and cabinet combination to overturn.

PORTABLE CABINET WARNING

- 9 **Ventilation** - Slots and openings in the cabinet and the back or bottom are provided for ventilation and to ensure reliable operation of the TV/DVD and to protect it from overheating, and these openings must not be blocked or covered. The openings should never be blocked by placing the TV/DVD on a bed, sofa, rug, or other similar surface. This TV/DVD should never be placed near or over a radiator or heat register. This TV/DVD should not be placed in a built-in installation such as a bookcase or rack unless proper ventilation is provided or the manufacturer's instructions have been adhered to. Around the unit, the space should be more than 10cm.
- 10 **Power Sources** - This TV/DVD should be operated only from the type of power source indicated on the marking label. If you are not sure of the type of power supply to your home, consult your appliance dealer or local power company.
- 11 **Grounding or Polarization** - This TV/DVD is equipped with a polarized alternating - current line plug (a plug having one blade wider than the other). This plug will fit into the power outlet only one way. This is a safety feature. If you are unable to insert the plug fully into the outlet, contact your electrician to replace your obsolete outlet. Do not defeat the safety purpose of the polarized plug.
- 12 **Power-Cord Protection** - Power-supply cords should be routed so that they are not likely to be walked on or pinched by items placed upon or against them, paying particular attention to cords at plugs, and the point where they exit from the appliance.
- 13 **Lightning** - For added protection for this TV/DVD receiver during a lightning storm, or when it is left unattended and unused for long periods of time, unplug it from the wall outlet and disconnect the antenna or cable system. This will prevent damage to the TV/DVD due to lightning and power-line surges.
- 14 **Power Lines** - An outside antenna system should not be located in the vicinity of overhead power lines or other electric light or power circuits, or where it can fall into such power lines or circuits. When installing an outside antenna system, extreme care should be taken to keep from touching such power lines or circuits as contact with them might be fatal.

- 15 **Overloading** - Do not overload wall outlets and extension cords as this can result in a risk of fire or electric shock.
- 16 **Object and Liquid Entry** - Never push objects of any kind into this TV/DVD through openings as they may touch dangerous voltage points or short out parts that could result in a fire or electric shock. Never spill liquid of any kind on the TV/DVD.
- 17 **Servicing** - Do not attempt to service this TV/DVD yourself as opening or removing covers may expose you to dangerous voltage or other hazards. Refer all servicing to qualified service personnel.
- 18 **Damage Requiring Service** - Unplug this TV/DVD from the wall outlet and refer servicing to qualified service personnel under the following conditions:
 - A. When the power-supply cord or plug is damaged or frayed.
 - B. If liquid has been spilled, or objects have fallen into the TV/DVD.
 - C. If the TV/DVD has been exposed to rain or water.
 - D. If the TV/DVD does not operate normally by following the operating instructions. Adjust only those controls that are covered by the operating instructions, as improper adjustment of other controls may result in damage and will often require extensive work by a qualified technician to restore the TV/DVD to its normal operation.
 - E. If the TV/DVD has been dropped or damaged in any way.
 - F. When the TV/DVD exhibits a distinct change in performance - this indicates a need for service.
- 19 **Replacement Parts** - When replacement parts are required, be sure the service technician has used replacement parts specified by the manufacturer that have the same characteristics as the original part. Unauthorized substitutions may result in fire, electric shock, injury to persons or other hazards.
- 20 **Safety Check** - Upon completion of any service or repairs to this TV/DVD, ask the service technician to perform routine safety checks to determine that the TV/DVD is in proper operating condition.
- 21 **Heat** - This TV/DVD product should be situated away from heat sources such as radiators, heat registers, stoves, or other products (including amplifiers) that produce heat.
- 22 **Electrostatic** - In DVD mode, your DVD Disc may be playback from the first parts because of the electrostatic symptom.
- 23 **Secondary Switch** - When switching off, the apparatus is not completely switched off from the mains. To disconnect it from the mains, you have to unplug mains.

Table of Contents

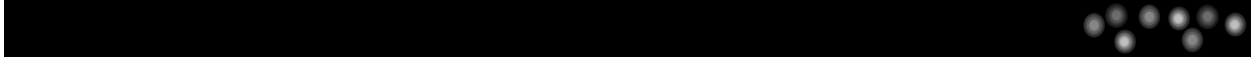

Before use

IMPORTANT SAFEGUARDS	1
Table of Contents	3
Identification of Controls	4
Remote Control	6

Installation

Basic Installation	9
Connecting to Various Equipment	10

Basic TV operation

Watching TV	14
TELETEXT	15
Setting TV	16
To Display the Setting Screen	16
Setting Picture	17
Setting Sound	18
Installing Channels	19
Setting Other Features	22

DVD Operation

Playing the DVD video disc.....	23
Basic Playback	23
Special Playback	24
Using DISPLAY Button	26
Playing the Desired Scene or	
Track during Playback	28
Directly Moving to the Desired Title.....	28
Playing the Disc, Chapter,	
Title, and Track Repeatedly	29
Repeating the Given Sections	29
Random Play	30
Program Play	31
Searching by Memorizing the Favorite	
Scene	32
Displaying menus in disc	33
Storing Viewed DVD settings	34
Changing Subtitle Language	35
Changing audio language	36
Using zoom feature	37
Viewing from Another Angle or Producing a	
3D SURROUND Effect	38
Playing an MP3 Disc.....	39
Initial Settings	42

Others

About DVD	51
Before Calling Service Personnel	53

IMPORTANT COPYRIGHT INFORMATION









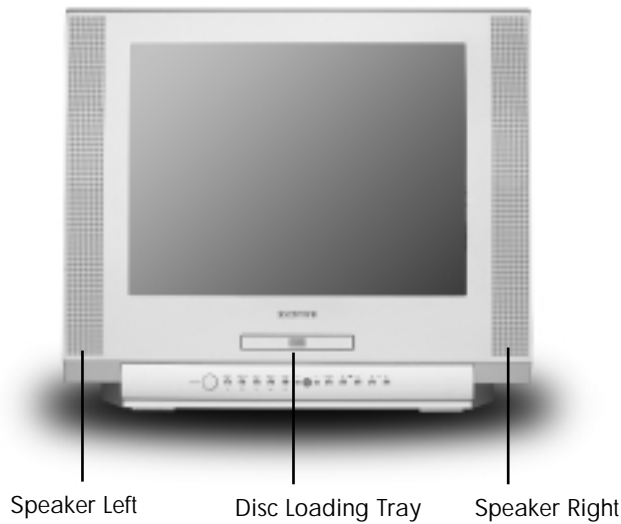



Unauthorized copying, broadcasting, public performance and lending of discs are prohibited.

DAEWOO

Identification of Controls

Main Body (Front Part)



-
-  ON/OFF POWER button (Power of TV/DVD is fully intercepted.)
 -  EJECT OPEN/CLOSE button (For opening disc tray)
 -  SKIP-B SKIP BACK button
 -  PLAY PLAY button
 -  SKIP-F SKIP FORWARD button
 -  STOP STOP button
 -  OPERATING STATUS indicator (This button is lit when playing a DVD)
 -  REMOTE SENSOR
 -  STAND-BY indicator
 -  TV/AV/DVD MODE CONVERT button
 -  TV VOLUME button
 -  TV CHANNEL button



Main Body (Rear and Side Part)

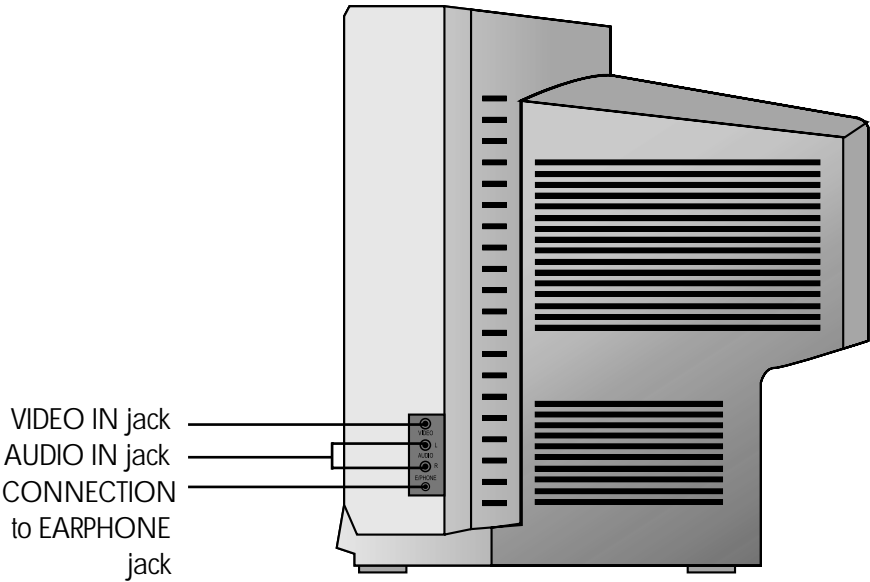
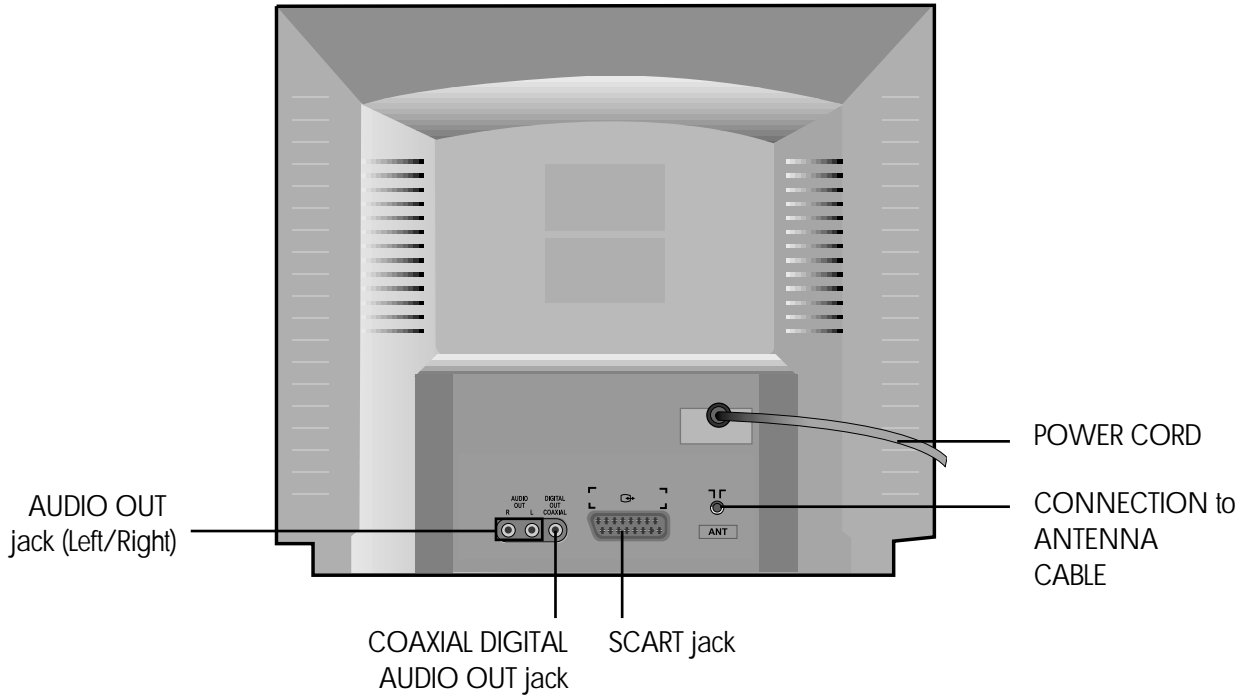

DAEWOO Remote Control

Remote Control Buttons



POWER button

If you press the ON/OFF button in the front part of this product, power is on.



DISPLAY button

Operating status and GUI(Graphic User Interface) menu are displayed in a screen.



TV/AV, DVD button

You can select input mode.



NORMAL button

NORMAL I/ NORMAL II/ FAVOURITE picture control

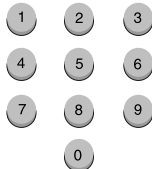

NUMBER button

You can enter the relevant number directly or select a desired channel.



PAUSE/STEP button

Pause screen and step screen are displayed whilst playing and pausing respectively.



SLEEP button

You can set automatic POWER OFF.



F.R/STEP or F.F/STEP button

You can search screen whilst playing back or forward.



STOP button



SKIP BACK/SKIP FORWARD button

You can skip a screen whilst playing back or forward.



PLAY button



TV MENU button

The Menu screen relating to TV is displayed.



VOLUME button



CURSOR(▲ ▼ ◀ ▶), CHANNEL SELECT button

This button functions as cursor or channel select button in setting TV/DVD and operating TV respectively.



MUTE button

Press this button if you only want to turn off the sound.



OK/ENTER button

Press this button if TV or DVD setting is completed.

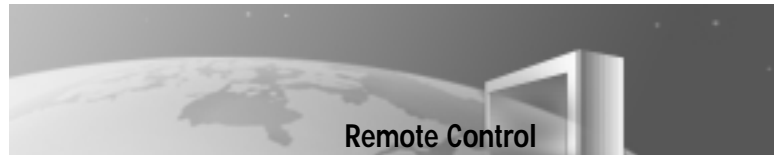

Remote Control



MENU/PBC button

The DVD menu screen is displayed.



AUDIO button

You can select the desired audio language.



SUBTITLE button

You can select the desired subtitle language.



DISC TRAY EJECT button



SETUP button

You can set the DVD player.



REPEAT button

You move into REPEAT mode whenever you press this button.



A-B REPEAT button

You can play the given sections repeatedly.



TITLE button

You can select the desired title.



Angle button

You can select the desired screen angle.



ZOOM button

You can zoom in a screen.



PROGRAM button

You can program the desired playing order.



RANDOM button

You can play the DVD randomly.



CLEAR button

You can clear settings.



MARKER button

You can mark the desired scene.



MARKER SEARCH button

You can reach the marked scene.

This button functions as a Marker Search button in DVD.



SOUND MODE button

You can select the desired audio mode when watching TV.



ASPECT button

You can modify TV Aspect in TV/AV1/AV2/DVD Mode.

Inserting the Batteries

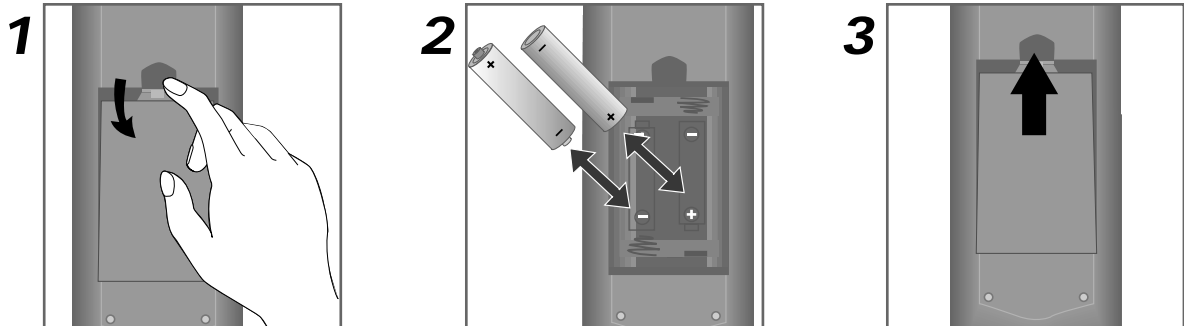

Please respect the environment and prevailing regulations. Before you dispose of batteries, ask your dealer whether they are subject to special recycling and if he accepts to take them back.

AERIAL SOCKET : (75Ohms-VHF/UHF/cable)

The aerial socket, located at the back of the TV/DVD set, enables the connection of an external aerial or one from another item of equipment fitted with a modulator (video recorder, satellite receiver, etc.).

(NB: A modulator converts basic video and sound signals to radio frequencies, 'R.F.'.)

MAINS PLUG:

The mains plug carries the power supply to your TV/DVD set. It should only be connected to an AC supply of 220-240V ~ 50Hz.

It must not be connected to a DC supply. If the plug is detached from the cable, do not under any circumstances connect it to a mains socket as there is a danger of electrocution.

UK SOCKET

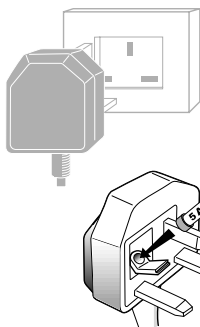

Equipment for the UK is supplied with a mains cable fitted with a moulded plug.

The plug contains safety components and must not be replaced by a type sold in shops. It is fitted with a fuse that protects your TV/DVD. If your set no longer works, the fuse may have blown. If it has, replace it with an identical ASTA certified or BSI (BS 1362) 5 amp fuse.

Basic Installation

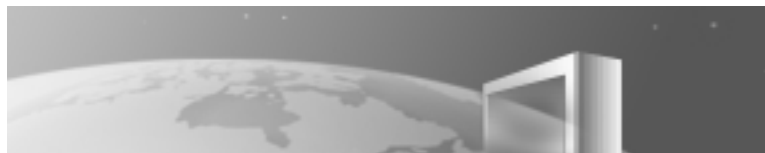

Connecting the Antenna Cable

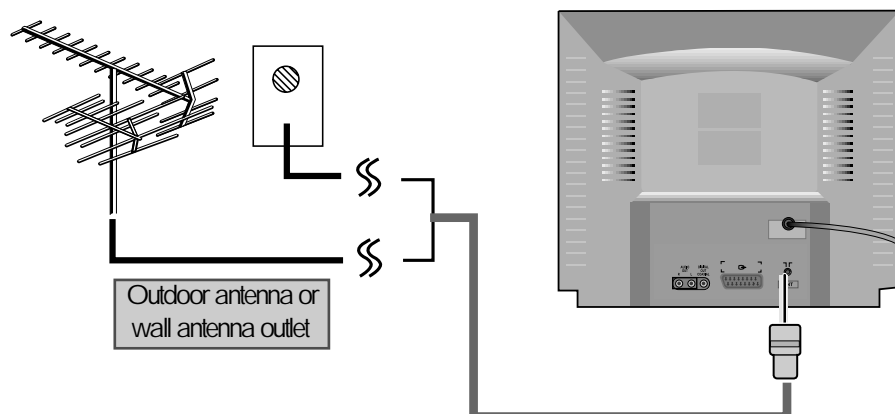

If TV picture is not clear, it usually result from the wrong antenna connection. Please install the antenna in the proper place and in the right direction.

Connecting a SCART SOCKET

This connection is used to connect this player to an external device (VCR, CAMCORDER, DVD) and to be displayed in TV/DVD. If the peripheral is powered on in TV mode, some peripherals are converted into AV1 mode automatically and displayed. Otherwise, you should press the TV/AV/DVD button to convert into AV1 mode. Pin specification of SCART SOCKET is as follows.

PIN	Signal Designation	Matching Values
1	Audio Out (linked with 3)	0.5Vrms, Imp < 1k Ω (RF 60% MOD)
2	Audio In (linked with 6)	0.5Vrms, Imp > 10k Ω
3	Audio Out (linked with 1)	0.5Vrms, Imp < 1k Ω (RF 60% MOD)
4	Audio Earth	
5	Blue Earth	
6	Audio In (linked with 2)	0.5Vrms, Imp > 10k Ω
7	Blue In	0.7Vp-p \pm 10%, Imp 75 Ω
8	Slow (Function) Switching	TV:0~2V, Peri:9.5~12V, Imp>10k Ω
9	Green Earth	
10	NC	
11	Green In	0.7Vp-p \pm 10%, Imp 75 Ω
12	NC	
13	Red Earth	0.7Vp-p \pm 10%, Imp 75
14	NC	
15	Red In	0.7Vp-p \pm 10%, Imp 75
16	Rapid Blanking, Switching	Logic 0: 0~0.4V, Logic 1: 1~3V, Imp 75 Ω
17	Video Earth	
18	Rapid Blanking Earth	
19	Video Out	1.0 Vp-p \pm 10%, Imp 75 Ω
20	Video In	1.0 Vp-p \pm 10%, Imp 75 Ω
21	Common Earth	

DAEWOO

Connecting to Various Equipment

Connecting to Audio System

You can enjoy the stereo sound.

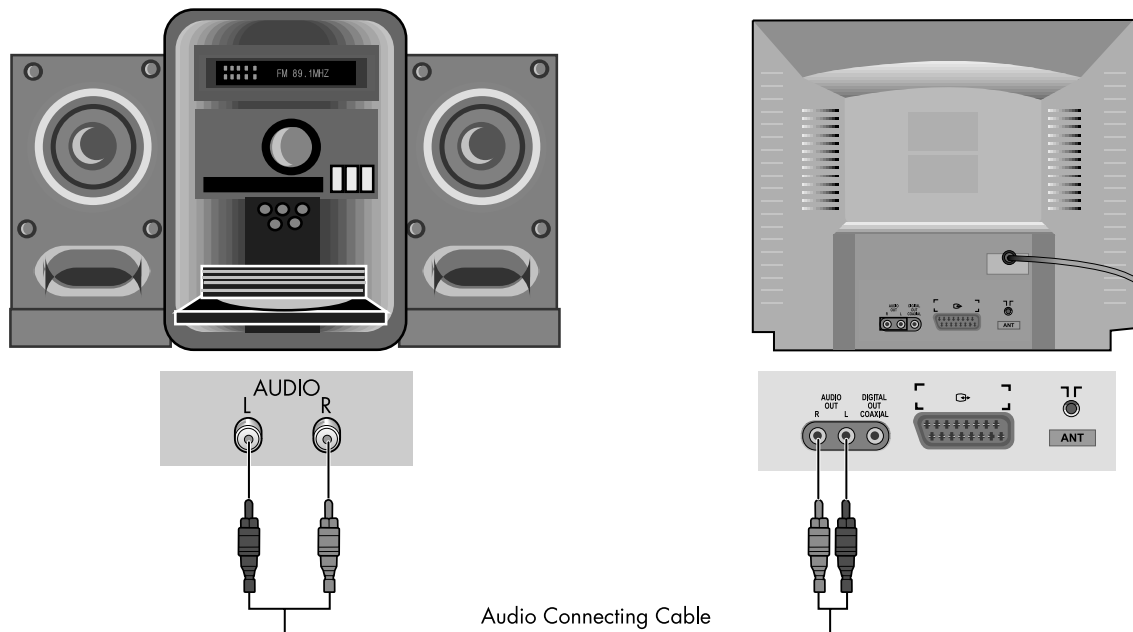

NOTE

- Refer to the owner's manual of your audio system to connect.
- Before you connect the TV/DVD to other equipment, be sure to turn off the power and unplug all of the equipment from the wall outlet before making any connections.
- If you place the TV/DVD near a tuner or radio, the radio broadcast sound might be distorted. In this case, move the TV/DVD away from the tuner and radio.
- The output sound of TV/DVD has a wide dynamic range. Be sure to adjust the receiver's volume to a moderate listening level. Otherwise, the speakers may be damaged by a sudden high volume sound.
- Turn off the audio system before you connect or disconnect the TV/DVD's power cord. If you leave the audio system power on, the speakers may be damaged.

Warning!!



Do not select "Dolby Digital" as Digital Audio Output of this TV/DVD unless you connect the DIGITAL OUT jack of this TV/DVD to an AV decoder that has the Dolby Digital decoding equipment.

High volume sound may damage your hearing as well as the speakers.
(Refer to "Selecting Digital Audio Output" on page 49)

Connecting to a Camcorder or Other Video Player

■ Connection with SCART Jack (AV1)

Connect the SCART jack of your video player (or camcorder) to SCART terminal of TV/DVD with SCART jack.

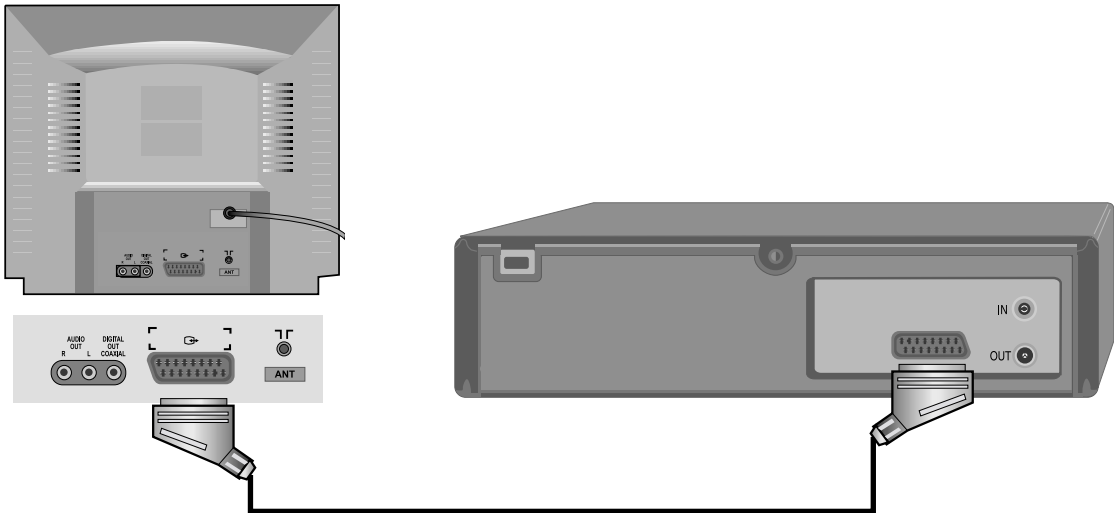

■ Connection with A/V Jack (AV2)

Connect the AUDIO/VIDEO OUT terminal of your video player (or camcorder) to AUDIO/VIDEO IN terminal of TV/DVD with Video/Audio Connecting Cable.

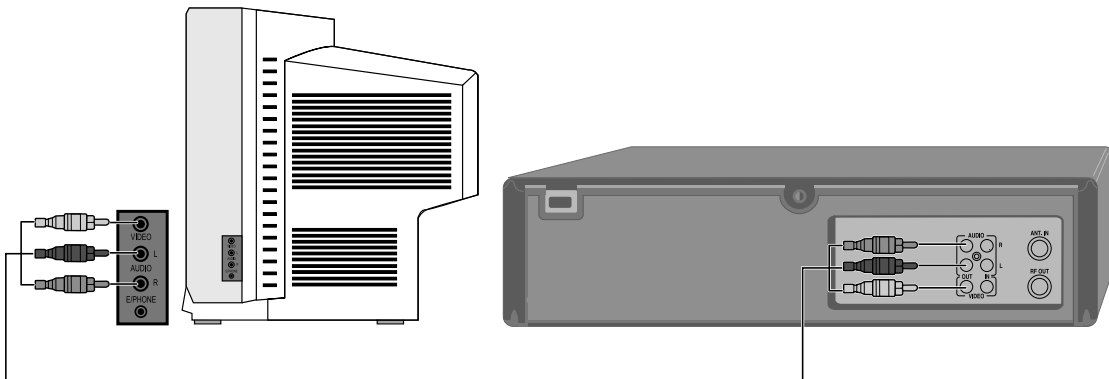

Connecting to Dolby Digital Amp

You can enjoy the high quality dynamic sound of Dolby Digital, Dolby Pro Logic, and 2 Channel Digital Stereo.

Dolby Digital?

Dolby Digital is the surround sound technology recently used in theatres, and is now available to reproduce this realistic effect at home. You can enjoy motion picture and live concert DVD video discs with this dynamic realistic sound by connecting the TV/DVD to the 6 channel amp equipped with a Dolby Digital decoder or Dolby Digital processor.

Amp equipped with Dolby Digital decoder

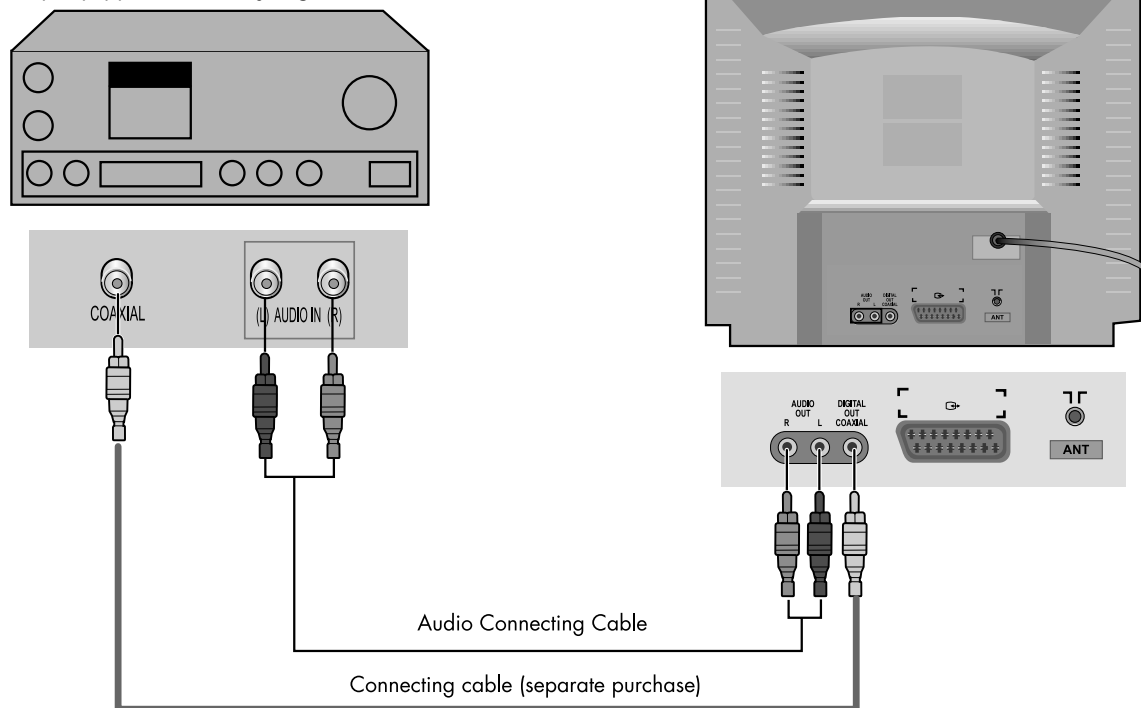

- 1 To enjoy Dolby Digital sound from this TV/DVD, you need the following:
 - DVD recorded in Dolby Digital
 - 6 channel amp equipped with a Dolby Digital decoder or Dolby Digital processor and power amp
 - 5 speakers and 1 subwoofer

- 2 To enjoy Dolby Digital sound
 - You need to select "Dolby Digital" in the SETUP menu.

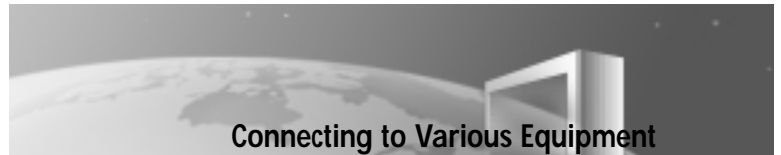

Connecting to Various Equipment

N O T E

- Refer to the owner's manual of your audio system to connect.
- Before you connect the TV/DVD to other equipment, be sure to turn off the power and unplug all of the equipment from the wall outlet before making any connections.
- The output sound of TV/DVD has a wide dynamic range. Be sure to adjust the receiver's volume to a moderate listening level. Otherwise, the speakers may be damaged by a sudden high volume sound.
- Turn off the audio system before you connect or disconnect the TV/DVD's power cord. If you leave the audio system power on, the speakers may be damaged.

This product has been manufactured under technical tie-up with Dolby Laboratories.

"Dolby" and the "double-D  " symbol are registered trademarks of Dolby Laboratories.

Copyright 1992-1997 Dolby Laboratories, Inc. All rights reserved.

DAEWOO

Watching TV

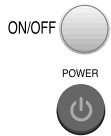

- 1** To turn on the TV, press the [ON/OFF] button in the front part of the set. Now TV set is in STANDBY status. Then, press the power button on the remote control.



- 2** **Selecting the Channel.**
Press the PR [▲, ▼] button or [Number] button to select the desired channel. If input status is set to AV or DVD, press the [TV/AV/DVD] button to select TV.



- 3** **Adjusting the Volume.**
Press the [◀VOL] button to decrease the volume level or [VOL ▶] button to increase the volume level.



- 4** To turn off the TV, press the [⏻] button on the remote control.
Pressing the ON/OFF button of the set will clear the clock memory. If power switch of remote control is off, standby LED becomes RED.

TELETEXT



SWITCHING TELETEXT ON/OFF

Press the TELETEXT button (⏏). The index page viewed last will appear. Press the TELETEXT button to return to the TV mode.

COLOUR BUTTONS IN TELETEXT

A red, green, yellow and cyan field is shown at the bottom of the screen. If FASTEXT is transmitted by the station, by pressing the corresponding colour button on the remote controller you can easily select the desired page.

SELECTING PAGES

The NUMBER buttons 0...9 are used to enter a page number. The selected page number appears at the top of the screen and the page appears after a short time. The UP/DOWN buttons increase or decrease the current page number by 1.

INDEX PAGE

You can switch directly to the overview page of the station you are currently viewing by pressing the INDEX button (⏏).

PAGE HOLD

Several sub pages can be combined under a page number and are scrolled at an interval determined by the TV station. The presence of sub pages is indicated by, for example, 3/6 beneath the time, which means that you are looking at the 3rd page of a total of 6 pages.

If you want to look at a subpage for a longer period of time, press the HOLD button (⏏). The contents of the subpage shown are kept on the screen and no longer updated or switched to other subpages. Pressing the HOLD button again, the current subpage appears.

CALLING UP SUBPAGE DIRECTLY

Pressing the SUBPAGE button (⏏) "Page no/..." appears at the bottom of the screen. Enter the subpage number that you want to call up with the NUMBER button 0...9, for example, the 2nd page. sequence 0002. The desired subpage is sought and displayed after a while. To exit, press SUBPAGE button (⏏) again.

WATCHING TELEVISION DURING TELETEXT MODE

Some pages are continually updated, for example, stock market reports, sports announcement, and the latest news. If you want to watch TV and stay informed at the same time, press CANCEL button (⏏).

The regular programme is still visible and the teletext symbol (⏏) appears at the top of the screen. Pressing the CANCEL button again, the teletext page appears with the updated information.

REVEAL ANSWER

This function can be used on certain pages to reveal the solution of riddles. Press the REVEAL button (⏏) to reveal a hidden answer and press again to hide it.

TV/TELETEXT (⏏)

Watch the TV programme and the Teletext pages simultaneously. The next press returns to the normal display.

BRIGHTNESS CONTROL IN TELETEXT MODE

Press the MENU button in teletext mode, the brightness control menu will be displayed in the bottom of the screen. You can adjust brightness using the corresponding colour button on the remote controller.

DOUBLING CHARACTER SIZE

Repeatedly pressing the SIZE button (⏏) doubles the character size in the following order.
Upper half of the page Lower half of the page Return to normal size.

DAEWOO

Setting TV

To Display the Setting Screen

TV MENU

- 1 Press the [TV MENU] button in TV mode.**
TV setting menu is displayed.

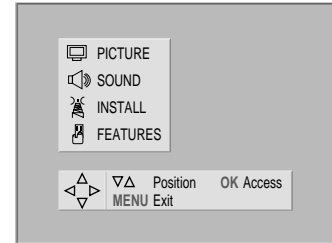

- 2 Press the [▲, ▼] button to select the desired item.**
Current settings and variable settings for the desired item are displayed in the screen.
 - PICTURE
 - SOUND
 - INSTALL
 - FEATURES



- 3 Press the [OK] button and press the [▲, ▼] button to set the desired item, then press the [OK/ENTER] button.**
Additional steps may be required as items.

TV MENU

- 4 Press the [TV MENU] button to exit the current setting menu.**



Setting Picture



1 Press the [**▲**, **▼**] button in TV setting screen to select "PICTURE" and press the [OK] button.

Setting menu is displayed.

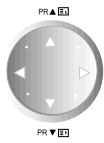
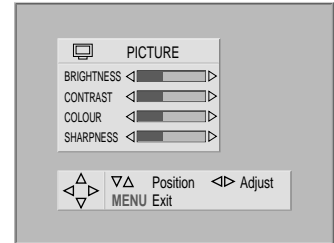

2 Press the [**▲**, **▼**] button to select the desired item, then press the [**◀**, **▶**] button to set the desired item.

Current settings and variable settings for the desired item are displayed in the screen.

- BRIGHTNESS: Adjust the picture until correct brightness is obtained.
- CONTRAST: Adjust brightness and darkness among objects and background in the screen.
- COLOUR: Adjust colour to display natural human's face colours.
- SHARPNESS: Adjust outlines of objects on screen to be smooth and clear.
- TINT: TINT adjustment is displayed if you receive NTSC through DVD play or AV input.



3 Press the [TV MENU] button after setting is completed.

Setting Sound



1 Press the [▲, ▼] button in TV setting screen to select "SOUND", then press the [OK] button.

Setting menu is displayed.

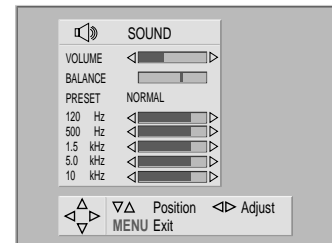

2 Press the [▲, ▼] button to select the desired item, then press the [◀, ▶] button to set the desired item.

Current settings and variable settings for the desired item are displayed on the screen.

- VOLUME
- BALANCE
- PRESET: You can select an item from either NORMAL, FAVOURITE1, FAVOURITE2, MUSIC, and SPEECH.

3 Press the [TV MENU] button after setting is completed.



Installing Channels

Setting on TV first after Shipment:
 If you are setting your TV set for the first time, features OSD screen is displayed. In this screen, select the desired language and press the [OK/ENTER] button, then Install screen is displayed. Now select your country and run Search function.



1 Press the [▲, ▼] button in TV setting screen to select "INSTALL", then press the [OK] button.
 Setting menu is displayed.

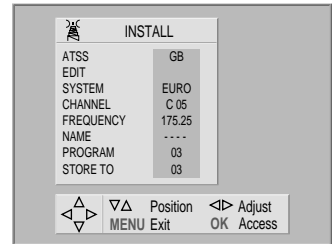

2 Running an ATSS(Automatic Tuning and Sorting System).
 If you select a country with [▲, ▼] button while the cursor points to ATSS and press the [OK] button over 3 seconds, channel is automatically tuned. In running the ATSS, "PLEASE WAIT!!" is displayed. When the ATSS is completed, the mode is converted into EDIT mode.



3 EDITING
 The EDIT menu shows you the programme position assignment. You can change this programme position assignment according to your personal preferences. Press the [▲, ▼] button in INSTALL screen to select "EDIT", then press the [OK] button. EDIT screen is displayed.

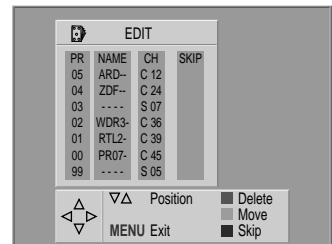

■ Delete

Select the PR to delete with the [▲, ▼] button and press the red button on the remote control.

■ Move

Select the PR to move with the [▲, ▼] button and press the green button on the remote control. Again, press the [▲, ▼] button to select the location to move it to. If you press the ▲ button, PR is increased and the desired channel replaces the previous PR channel. Press the green button on the remote control again, channel movement is completed.

■ SKIP

Select the PR to skip with the [▲, ▼] button, and press the yellow button on the remote control. SKIP column is checked. Press the PR [▲, ▼] button, channel is skipped.



4 Setting SYSTEM

Press the [▲, ▼] button in the INSTALL screen to select "SYSTEM" if the automatic tuning did not already select this correct system. Select a TV broadcasting type among EURO, E/EURO, FRANCE, and GB with [◀, ▶] button while the cursor points to SYSTEM.

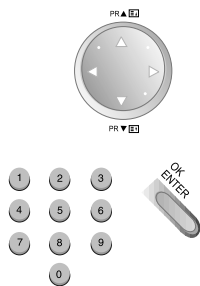

5 Setting CHANNEL

Press the [▲, ▼] button in the INSTALL screen to select "CHANNEL". Select a channel with the [▲, ▼] button or [NUMBER] button while the cursor points to CHANNEL. Press the [OK] button to select either Cable or Air.

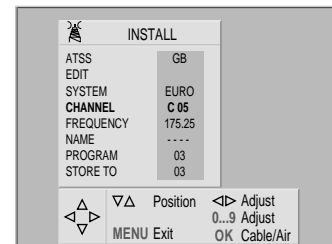

6 Setting FREQUENCY

Press the [▲, ▼] button in the INSTALL screen to select "FREQUENCY". While the cursor points to FREQUENCY, you can start Manual Tuning by pressing the [◀, ▶] button over 2 seconds. Also, you can start Fine Tuning step by step when you press the button quickly. To save adjusted values, you should save PROGRAM with STORE TO after adjusting.

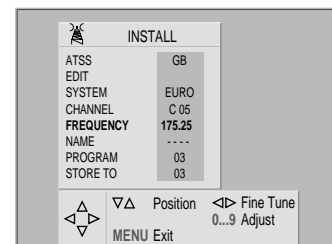

7 Setting NAME

* STATION NAME is mapped as broadcasting ID. If there is no broadcasting ID, STATION NAME is displayed as "- - - -". Press the [▲, ▼] button in the INSTALL screen to select "NAME". Enter the Modify mode by pressing the [◀, ▶] button while the cursor points to NAME. Press the [▲, ▼] button, characters are displayed in order. You can set a NAME consisting of 5 characters. Press the [OK] button to save the settings.



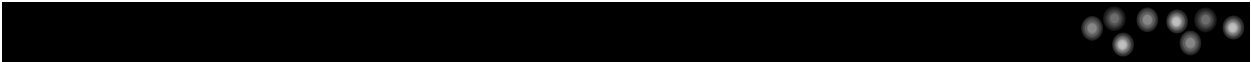
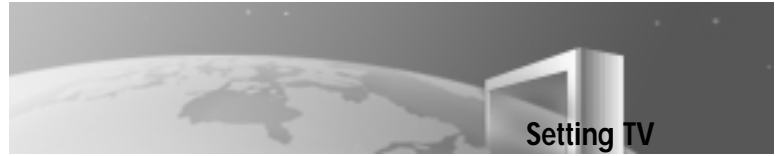

8

Setting PROGRAM

Press the [▲, ▼] button in the INSTALL screen to select "PROGRAM".

Press the [◀, ▶] button to set the desired PR while the cursor points to PROGRAM.

Whilst doing this channel as well as STORE TO are also changing.

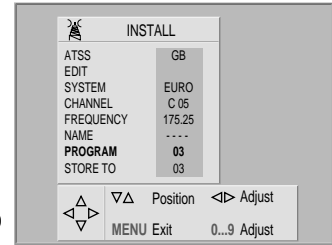

9

Setting STORE TO

* This function is used to save PROGRAM

Press the [▲, ▼] button in the INSTALL screen to select "STORE TO".

Press the [OK] button to store settings while the cursor points to STORE TO.

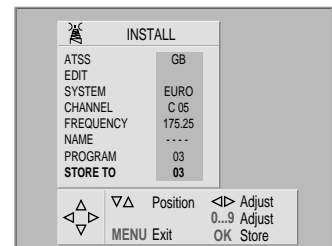

Setting Other Features



1 Press the [▲, ▼] button in the TV setting screen to select "FEATURES" and press the [OK] button.

Setting menu is displayed.

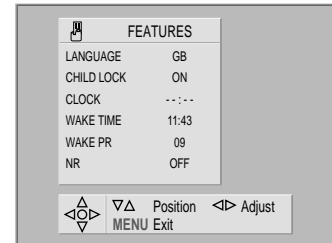

2 Press the [▲, ▼] button to select the desired item and press the [◀, ▶] button to set the item.

Current settings and variable settings for the desired item are displayed in the screen.

- LANGUAGE
- CHILD LOCK: Buttons in Setting menu are not operated (except ON/OFF SW). Only remote controller operates and standby LED blinks.
- CLOCK
- WAKE TIME: TV is turned on automatically at the desired time.
- WAKE PR: Desired channel is turned on automatically at the desired time.
- NR(Noise Reduction)

TV MENU

3 Press the [TV MENU] button after setting is completed.

AUTO CLOCK SET

Normally the clock will set itself automatically if this channel set to PRO1 has teletext. However, if PRO1 doesn't have teletext the clock will have to be set manually. NB. Remember the clock setting will be lost if the On-Off button on the front of the set is operated.

Playing the DVD Video Disc

Basic Playback

- ◆ When you want to enjoy the sound of DVD video discs or audio CDs from the audio system, turn on the audio system and select the input source connected to the TV/DVD.
- ◆ If you do not have the necessary equipment to enjoy Dolby Digital sound, set the Digital Audio Output via the SETUP menu to "PCM (Pulse Code Modulation)".

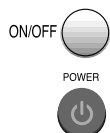

1 Press the [ON/OFF] button on the front part of the set to enter STANDBY mode and press the  button on the remote control, then the TV/DVD turns on.



2 Press the [EJECT] button to open disc tray.
Place a disc on the disc tray with the playback side down.



3 Press the [PLAY ▶] button.
Disc tray is closed automatically and play begins.
DISC indicator is displayed on the TV screen.

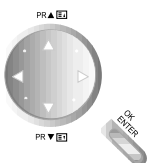

4 In the menu screen displayed on the screen.
Press the [▲, ▼, ◀, ▶] button to select the desired item, then press the [OK(ENTER)] button or the relevant number directly.
The selected item is played.

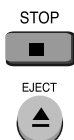

5 Press the [STOP ■] button to stop play.
Press the [||] button to pause play.
Press the [EJECT] button to remove the loaded disc.

NOTE

- Do not move the TV/DVD during play. Doing so may damage the disc and TV/DVD.
- Use the [EJECT] button on the remote control or TV/DVD to open and close the disc tray. Do not push the disc tray while it is moving. Doing so may cause TV/DVD to malfunction.
- Do not push up the disc tray or put any objects other than discs on the disc tray. Doing so may cause the TV/DVD to malfunction.
- Be careful of the disc tray not to bite your finger as it is closing. Especially, be careful as it will seriously hurt children.
- When  appears on the TV screen while a button is pressed, it means that this function is not available on the disc you are playing.
- Depending on the DVD disc, some operations may be different or restricted. Refer to the instructions of the disc you are playing.

Special Playback



RESUME Play

When play is stopped, the unit records the point where the [STOP ■] button was pressed. Press the [Play ▶] button and play will resume from this point.

NOTE

- Resume function will be cleared when the [STOP] button is pressed in the STOP mode.
- Resume function will not work if you turn off the TV/DVD and turn on the TV/DVD again.
- Resume function will not work when the disc tray is opened.
- The Resume function may not be available with some DVD discs.



PAUSE (Still picture)

Press the [PAUSE/STEP ||] button during play.

The TV/DVD will be placed in the still picture mode.

* If CD disc is loaded, the TV/DVD will be placed in the pause mode. (Be attention as loading takes long time.)



Step by Step screen

{DVD (Digital Versatile Disc)/ VCD (Video Compact Disc)}

Press the [PAUSE/STEP ||] button during the screen pauses.

Each time you press the [PAUSE/STEP ||] button, the picture advances one scene.

* To resume normal play, press the [PLAY] button.



SKIP FORWARD

Press the [SKIP-F ▶▶] button during play.

It skips forward by one unit(chapter or track) whenever the button is pressed.



SKIP BACK

Press the [SKIP-B ◀◀] button during play.

When the button is pressed during playback a unit(chapter or track), it returns to the start of the unit. When it is pressed again, it skips back whenever the button is pressed.

- ✓ If you press the [SKIP-F ▶▶] button or [SKIP-B ◀◀] button when Tuning Play menu of VCD2.0 is displayed, sometimes menu screen may be displayed again.

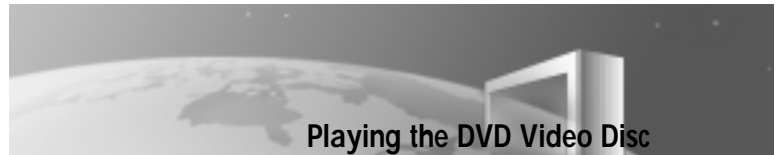

■ Search Forward

Press the [F.F/STEP ►►] button during playback. Each time the button is pressed, you can search the picture forward (at Play →►► x2 →►► x4 →►► x16 →►► x100 →► ... speed)



■ Search Back

Press the [F.R/STEP ◀◀] button during playback. Each time the button is pressed, you can search the picture back (at Play →◀◀ x2 →◀◀ x4 →◀◀ x16 →◀◀ x100 →◀ ... speed)



■ Forward Playback in Slow-Motion {DVD/VCD}

Press the [F.F/STEP ►►] button during the paused mode. Each time the button is pressed, you can play the screen in slow-motion (at Pause →► x1/16 →► x1/8 →► x1/4 →► x1/2 →► ... speed)



■ Reverse Playback in Slow-Motion {DVD/VCD}

Press the [F.R/STEP ◀◀] button during the paused mode. Each time the button is pressed, you can play the screen in slow-motion (at Pause →◀ x1/16 →◀ x1/8 →◀ x1/4 →◀ x1/2 →◀ ... speed)

NOTE

- The sound is muted during slow-motion play or search scene. But, the speed sound is audible during searching an Audio CD forward/back.
- Search speed increases up to 3 steps for VCD. (x2, x4, x8)
- Search speed of Audio CD can be increased only up to x2.
- Subtitles do not appear on the screen during slow-motion play.
- Slow-motion play increases up to 3 steps for VCD. (x1/4, x1/8, x1/16)
- Reverse playback in slow-motion is not available for VCD.
- Slow-motion play is not available for Audio CD.

SCREEN SAVER

The Screen saver is useful for preventing your display from becoming damaged. The screen saver picture appears when you leave the TV/DVD in stop mode for about 3 minutes.

DAEWOO Using Display Button

To Display GUI Menu

This unit features GUI(Graphic User Interface) Menu showing disc information (title /chapter /track number, elapsed playing time, audio/subtitle language, angle, and sound) and TV/DVD information (repeat play, play mode, marker, etc.) Some icons only show the indicated information. Other icons allow the settings to be changed.

DISPLAY



1

Press the [DISPLAY] button during playback.

Title function can be accessed from the stop mode.



2

Press the [▲, ▼] button to select the desired item.

The current selected item is indicated in yellow on its GUI menu.

(DVD GUI)	
T 1	
C 1	
0:16:57	
1 ENG D D 6 CH	
OFF	
1	
NORM.	

It shows the current title number. Jump to the desired title number by pressing the [◀, ▶] button or the [NUMBER] button, then press the [OK/ENTER] button.

It shows the current chapter number. Jump to the desired chapter number by pressing the [◀, ▶] button or the [NUMBER] button, then press the [OK/ENTER] button.
* You can move at once by pressing the [SKIP-F] button or [SKIP-B] button.

It shows the elapsed time. Press the [NUMBER] button to set time, select directly scenes by the desired time, then press the [OK/ENTER] button.

It shows the current audio soundtrack language, encoding method, and channel number. Press the [◀, ▶] button or [🔊] button to change the settings.

It shows the current subtitle language. Press the [◀, ▶] button or [🗨️] button to change the setting.

It shows the current angle number. Press the [◀, ▶] button or [🎥] button to change the angle.

It shows the current sound (NORMAL, 3D SURROUND, DOLBY PROLOGIC or DOLBY 3 STEREO). Press the [◀, ▶] button to change the setting.

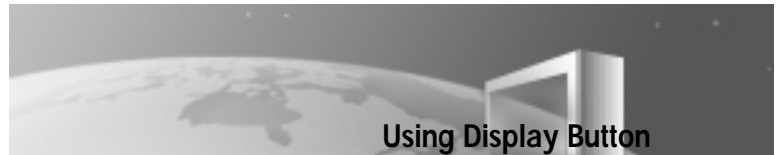

To Display GUI Menu

(VCD/CD GUI)

 1
 16:57
 STER.
 NORM.

It show the current track number. Jump to the desired track number by pressing the [◀, ▶] button or the [NUMBER] button, then press the [OK/ENTER] button.
* You can move at once by pressing the [SKIP-F] button or [SKIP-B] button.

It shows the elapsed time.

It shows the current audio (STEREO, LEFT, RIGHT). Press the [◀, ▶] button or [🔊] button to change the desired audio channel.

It shows the current sound(NORMAL, 3D SURROUND, DOLBY PROLOGIC or DOLBY 3 STEREO). Press the [◀, ▶] button to change the setting.



3

Press the [◀, ▶] button to select the desired setting.

- When numbers such as title number are displayed, the [NUMBER] button can also be used for setting instead of the [◀, ▶] button.
- For some functions, the setting will be registered immediately; for others, the [OK/ENTER] button must be pressed.



4

To clear the GUI Menu Icons, press the [DISPLAY] button again.



NOTE

- Some of the above GUI menu may not work on certain DVD discs.
- Track icon is not displayed in VCD 2.0.
- Examples of GUI Menu Icons (The screens may differ depending on the disc contents)

(GUI in VCD 2.0)

 STER.
 NORM.
 16:57

(GUI in REPEAT PLAY mode)

 1/5
 CHAPT /  TRACK
 TITLE /  ALL
 A B
 OFF

Playing the Desired Scene or Track during Playback

Directly Moving to the Desired Title

Some movie discs may contain multiple titles. If the disc has a movie title menu recorded on it, the [TITLE] button can be used to select the movie title. Details of operation may differ depending on the disc used.

* Selecting a title may not be available on certain DVD discs.



1

Press the [TITLE] button.

A list of the titles on the disc is displayed. Pressing the [TITLE] button again to resume play from the scene when the [TITLE] button was first pressed.



2

Press the [OK/ENTER] button or [PLAY] button after pressing the [▲, ▼, ◀, ▶] button to select the desired title.

The selected title now starts playing.



Playing the Disc, Chapter, Title and Track Repeatedly



Press the [REP] button during play.

Each time this button is pressed, the TV screen changes and the disc will repeat the chapter, title or track.

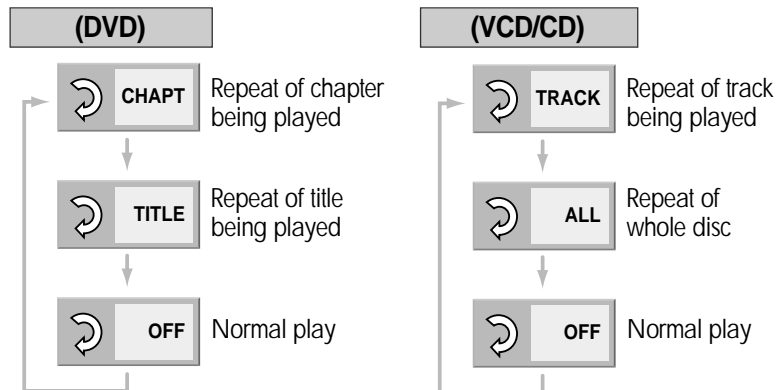

- * If the [REP] button is pressed during program play, repeat play is operated: "Repeat of the current programmed track" --> "Repeat of all programs" --> "Program play".
- * To return to normal play, press the [REP] button until "OFF" is displayed.

Repeating the Given Sections



1

Press the [A-B] button where you want to Play repeatedly.



- * It directly converts to "OFF" mode when you press the [CLEAR] button.



2

Press the [A-B] button where you want to end repeat paly.



Repeat play of the selection between points A and B starts.

- * To return to normal play, press the [REP] button until "OFF" is displayed.

NOTE

- Repeat play is available only with discs for which the elapsed playing time appears during play.
- Repeat play may not work properly on some DVDs.
- A-B repeat play is available only within a title or a track.
- Some subtitles around point A or B may fail to appear according to DVD type.

Random Play

You can play titles or tracks in random order



RANDOM

1

Press the [RANDOM] button during stop mode.

TV/DVD automatically begins Random Play.

If you press the [RANDOM] button during Normal Play, the TV/DVD selects other titles (or tracks) randomly and begins to play.



RANDOM

2

To return to normal play, press the [RANDDOM] button during random play.

NOTE

- **Notice: This function is only available with music CD, video CD disc. Random play does not work properly with DVD movie discs.**
- Random play may not be available with certain discs.
- If you press the [SKIP-B ►►] or [SKIP-F ◄◄] button during random play, the TV/DVD goes to another track randomly and starts play.

Program Play

The TV/DVD plays the tracks on the disc in the order you specify.



PGM

1 Press the [PGM] button in the play or stop mode.

The program play screen appears on the TV screen.

* To exit the screen, press the [PGM] or [PLAY] button.

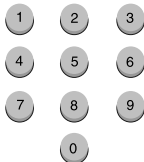
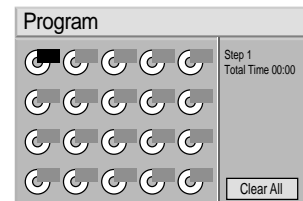

2 Press the [▲, ▼, ◀, ▶] button and press the [NUMBER] button to select the desired track number.

Up to 20 tracks can be programmed.

Clearing the program...

- To clear the programmed tracks one by one
Press the [▲, ▼, ◀, ▶] button to select the unwanted number, then press the [CLEAR] button.
- To clear all the programmed tracks
Press the [▲, ▼, ◀, ▶] button to select "Clear All", then press the [OK/ENTER] button. Press the [Play] or [OK/ENTER] button to exit the screen.

N.B. The programs are not cleared when the [PGM] button is pressed to exit the screen. (The programs are also cleared when the power is turned off or the disc is removed.)

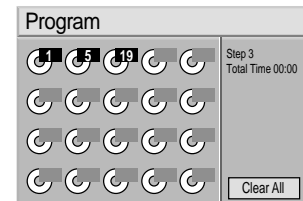

3 Press the [PLAY] or [OK/ENTER] button.

The selected tracks are stored in player's memory and play begins with the first one programmed.

N.B. If the [PGM] button is pressed to exit the screen, the selected tracks are not stored in the memory.

* After playing all tracks programmed, play is stopped.

NOTE

- Notice: Program play function is available only with music CD/video CDs. It does not work with DVD movie discs and video CD (version 2.0).

Searching by Memorizing the Favorite Scene

You can play the favorite scenes as if you mark the favorite pages of a book.



1

Press the [MARKER] button on the scene to be viewed(listened) again.



Indication of "1/5" is stored in the memory. Up to 5 scenes can be stored in the memory.



2

Press the [MARKER SEARCH] button during play.

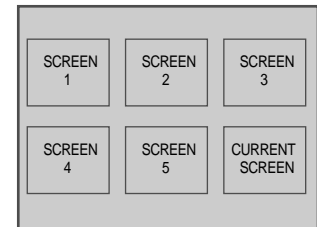

The stored scenes and current scene are displayed in the screen.



3

Press the [▲, ▼, ◀, ▶] button to select the scene, then press the [OK/ENTER] button to play the selected scene.

Play starts from the selected scene.

* To clear the selected scene, press the [CLEAR] button. The current scene may not be cleared.

NOTE

- Some subtitles recorded around the marked scenes may fail to appear on certain DVD discs.
- All the marked scenes are cleared when the power is turned off or the disc is removed.
- The marked scenes are not stored when the DVD or title menu is displayed on the TV screen.

Displaying menus in disc

Using DVD menu

Some DVD discs have single menu structures called DVD menus. For example, DVDs programmed with complex contents provide guide menus, and those recorded with various languages provide menus for audio menu and subtitle language.

* The contents of DVD menu and operation differ from disc to disc.

MENU/PBC

1 Press the [MENU/PBC] button during play.

The DVD menu available on the disc is now displayed.

By pressing the [MENU/PBC] button again resumes play from the scene where the [MENU/PBC] button was first pressed.



2 Press the [OK/ENTER] button or the [NUMBER] button(s) after pressing the [▲, ▼, ◀, ▶] button to select desired item.



Example of DVD menu

The selected item is now displayed.



Storing Viewed DVD Settings

Storing Viewed DVD Settings

This function allows you to store viewed DVD settings. Even though you remove a disc or turn off the [ON/OFF] button, the settings are still stored. If you place the viewed DVD in the disc tray again, "Resume disc from last position?" message is displayed on the screen. If you play the DVD, the stored settings are automatically called.

1 Place the viewed DVD.

TV screen is displayed as follows.
But, if you do not press any button within 10 seconds, the DVD player is automatically played.

Resume disc from
last position?

1. No 2. Yes

2 Press the [◀, ▶] button to select "2. Yes" and press the [OK/ENTER] button.

The stored settings are automatically called and the player resumes disc play from last play position.



NOTE

- The TV/DVD can store the following 6 settings.
 - Last viewed scene (Resume function)
 - TV Aspect
 - Disc Audio language
 - Disc Subtitle language
 - Disc Menu language
 - Camera
- Every setting is stored.
- Only the DVD setting can be stored.
- If you remove a disc or press the [⏻] button to turn off the power when the DVD or title menu is displayed on the TV, settings are not stored.

Changing Subtitle Language

Changing Subtitle Language

In the SETUP screen, you can select the initial subtitle and change to other language. This function works only if the subtitle languages are recorded in multiple languages.



1

Press the [⋮] button during play.

If there is no subtitle, "OFF" or "⊗" instead of language is displayed.

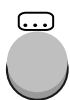

2

Press the [⋮] button repeatedly until the desired language is selected.

* To clear an on-screen subtitle, press the [⋮] button repeatedly and select "OFF".



NOTE

- Subtitle language may not be converted into the selected language immediately.
- When you play a disc with caption function, subtitle and caption title can be overlapped in the TV screen of caption mode. In this case, turn off the caption function or turn off the caption of TV set.

DAEWOO

Changing Audio Language

Changing Audio Language

In the SETUP screen, you can select the initial audio and change to other language. This function works only if the subtitle languages are recorded in multiple languages.



1 Press the [] button during play.



- DVD -



- VCD/CD -



2 Press the [] button repeatedly until the desired language is selected.



- DVD -



- VCD/CD -

NOTE

- If the desired language is not selected by pressing the button several times, it means the language is not available.
- When the power is turned off or disc is removed, the subtitle is displayed in a language of the SETUP menu. Language in the disc is displayed if this language is not recorded in the disc.
- Some discs may not be changed by pressing the [] button.

Using Zoom Feature

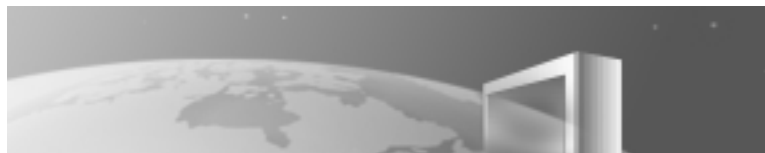

Using Zoom Feature

The Zoom feature allows you to enlarge the video image 4 times or 16 times.



1 Press the [Q] button during play or pause.

The region to zoom in the centre of the screen is displayed.

Whenever you press the [Q] button, the TV screen is changed as shown on the right.

Zoom magnification is displayed in the right top of zoom region.

Press the [▲, ▼, ◀, ▶] button to move the zoom region.

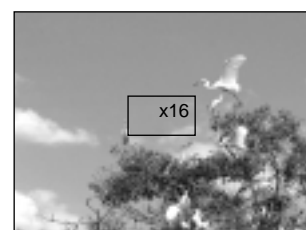
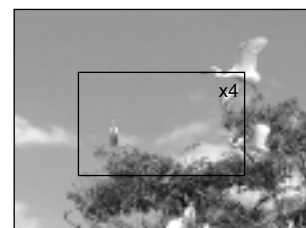

2 Press the [OK/ENTER] button.

The selected screen is displayed as full screen.



3 To resume normal screen,

Press the [Q] button again to release the Zoom feature, play or pause screen is displayed.

NOTE

- Some discs may not respond to the Zoom feature.
- The Zoom Feature is not available with subtitles or menus included on DVD video discs.

Viewing from Another Angle or Producing a 3D SURROUND Effect

Viewing a Scene from Another Angle

Some DVDs may contain scenes which have been shot simultaneously from a number of different angles. For these discs, the same scene can be viewed from each of these different angles using the [] button.

* The recorded angles differ depending on the disc used.



1 Press the [] button during play.



2 Press the [] button repeatedly until the desired angle is selected.



NOTE

- This function only works for discs having scenes recorded at different angles.

Producing a 3D SURROUND Effect



This unit can produce a 3D Surround effect, using 3D Surround Sound technology, which simulates multi-channel audio play from two conventional stereo speakers instead of five or more speakers required to listen to multi-channel audio at home theatre. This feature works with DVD discs encoded with Dolby Pro Logic and Dolby Digital audio tracks.

DISPLAY



1 Press the [DISPLAY] button during play.



2 Press the [, ] button repeatedly until the desired sound is selected.



NOTE

- This 3D Surround effect may not be available in some DVD discs recorded with a mono audio soundtrack.
- Turn off the TV surround sound and other surround effects when using this 3D surround effect.
- For the best 3D Surround effect using only two speakers, it is recommended that the two speakers be positioned approximately 183cm to 244cm apart, and the listening position should be 183cm to 244cm away from the speakers.

Playing an MP3 Disc



Playing an MP3 File

1 Press the an MP3 disc in the machine.

The MP3 menu is displayed.

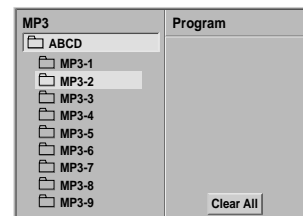

2 Press the [▲, ▼] button to select a directory containing the desired MP3 file, then press the [OK/ENTER] button.

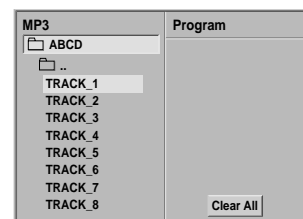

3 Select the desired MP3 file in the selected directory by pressing the [▲, ▼] button.

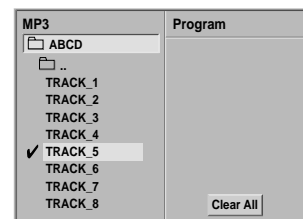

4 Press the [OK/ENTER] or [PLAY] button to play a file.

- Press the [SKIP-F] or [SKIP-B] button to play the next file or previous file during playback.
- If you press the [TITLE] button during play, the first page of the current directory is displayed. Then, if you press the [TITLE] button within 5 seconds again, the next page is displayed.
- To move to the initial directory during play, press the [MENU/PBC] button.

NOTE

- The file and directory name are only displayed in English.
- If there is an impossible code to display, (_) is displayed instead of English.
- If there is no MP3 file in a directory, ⓪ is displayed as the directory name.
- This unit can play up to 256 directories or 256 files per disc.
- Disc format is compatible with ISO9660 only.
- Please record MP3 files using the software that can create a FILE SYSTEM. Otherwise, these MP3 files cannot be played.

Ex) If you use Direct-CD creator software, it is recommended that you must use "Easy-CD Creator", which creates an ISO9660 file system.

- If other files instead of MP3 files are already stored on the CD-R/RW disc, do not use that disc. Please use a new disc.

Programming an MP3 File

1 Press the an MP3 disc in the machine.
The MP3 menu is displayed.

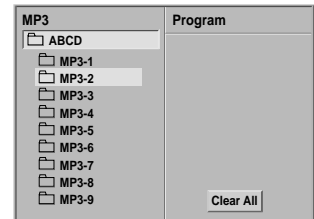

2 Press the [**▲**, **▼**] button to select a directory containing the desired MP3 file, then press the [**OK/ENTER**] button.

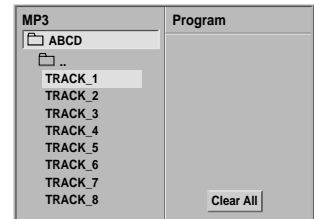

3 Select the desired MP3 file in the selected directory by pressing the [**▲**, **▼**] button.

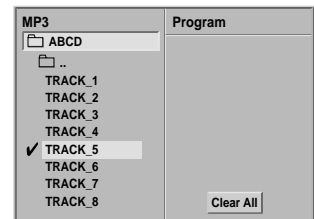

4 Press the [**PGM**] button to add the selected file to a program list.
Repeat step 3-4 to select another track.
Up to 60 files can be programmed.

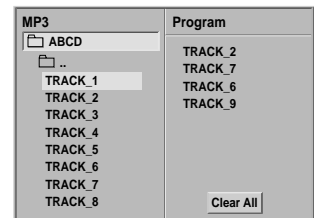

5 Press the [**▶**] button to select the desired MP3 file and press the [**OK/ENTER**] button or [**PLAY**] button to begin playback.

If you want to enter the main menu, press the [**◀**] button.
After playing all tracks, programmed play is stopped.

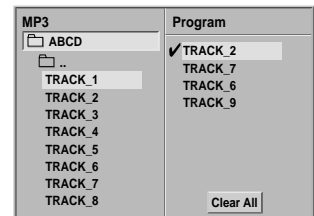

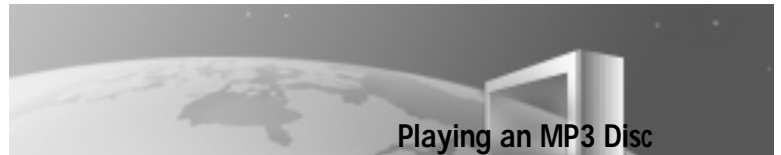

Playing Repeatedly and Editing the Programmed MP3 File

■ Playing an MP3 file repeatedly



REP

- If you press the [REP] button once during play, the current MP3 file will play repeatedly.

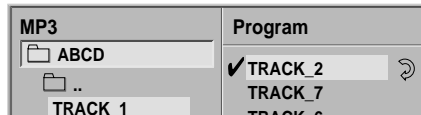

REP

- If you press the [REP] button twice during play, all MP3 files on the disc will play repeatedly.

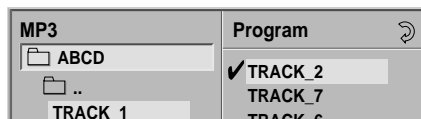

- If you press the [REP] button three times, repeat play will be cancelled.

■ Clearing MP3 files one by one



PR



CLEAR

- Press the [▲, ▼, ◀, ▶] button to select the unwanted MP3 file on the program list, then press the [CLEAR] button.

■ Clearing all the MP3 files in the program list



PR



OK
ENTER

- Press the [▲, ▼, ◀, ▶] button to select the "Clear All" and press the [OK/ENTER] button.

DAEWOO Initial Settings...

General Information of Initial Settings

Once the initial settings have been completed, the TV/DVD can always be operated under the same conditions. Especially with DVD discs, the settings will be retained in the memory until they are changed even though the power is off.



1 Press the [SETUP] button in the stop or play mode.

The initial settings menu is displayed.



2 Press the [▲, ▼] button to select the desired item.

The screen will show the current setting for the selected item, and the alternate setting(s).

- Disc Audio (see page 43)
- Disc Subtitle (see page 43)
- Disc Menu (see page 43)
- Rating (see page 45)
- Password (see page 46)
- TV Aspect (see page 47)
- Menu Language (see page 48)
- Digital Audio Output (see page 49)
- Others (see page 50)



3 Press the [▶] button and then the [▲, ▼] button to select the desired setting and press the [OK/ENTER] button.

Some items require additional steps.



4 To exit the current SETUP menu, press the [SETUP] or [PLAY] button.



Selecting disc languages {DVD Only}

In the initial settings, you can select Disc Audio, Disc Subtitle and Disc Menu for all discs to be played.
When you play the DVD video disc including Disc Subtitle, the TV/DVD automatically displays the pre-selected subtitle language.



1 In the SETUP screen, press the [**▲**, **▼**] button to select “Disc Audio” and press the [**▶**].



2 Press the [**▲**, **▼**] button to select the desired language and then press the [**OK/ENTER**].

- Original: The original language of each disc will be selected.
- Korean, English: The Korean and English will be selected.
- Other: Other languages can be selected. You can input 4-character language code. (Refer to the language codes on the next page. Press the [CLEAR] button if an incorrect language code is entered.)

3 The “Disc Subtitle” and “Disc Menu” are selected by the same method.

NOTE

- If the language selected is not recorded on the disc, the original language designated by each disc will be selected.

Table of Language Codes and Their Abbreviations

Enter the appropriate language code for the initial settings of "Disc Audio", "Disc Subtitle" and/or "Disc Menu".

Code	Language	Code	Language	Code	Language	Code	Language
6565	Afar	7079	Faroese	7678	Lingala	8375	Slovak
6566	Abkhazian	7082	French	7679	Laothian	8376	Slovenian
6570	Afrikaans	7089	Frisian	7684	Lithuanian	8377	Samoan
6577	Ameharic	7165	Irish	7686	Latvian, Lettish	8378	Shona
6582	Arabic	7168	Scots Gaelic	7771	Malagasy	8379	Somali
6583	Assamese	7176	Galician	7773	Maori	8381	Albanian
6588	Aymara	7178	Guarani	7775	Macedonian	8382	Serbian
6590	Azerbaijani	7185	Gujarati	7776	Malayalam	8385	Sundanese
6665	Bashkir	7265	Hausa	7778	Mongolian	8386	Swedish
6669	Byelorussian	7273	Hindi	7779	Moldavian	8387	Swahili
6671	Bulgarian	7282	Croatian	7782	Marathi	8465	Tamil
6672	Bihari	7285	Hungarian	7783	Malay	8469	Telugu
6678	Bengali, Bangla	7289	Armenian	7784	Maltese	8471	Tajik
6679	Tibetan	7365	Interlingua	7789	Burmese	8472	Thai
6682	Breton	7378	Indonesian	7865	Nauru	8473	Tigrinya
6765	Catalan	7383	Icelandic	7869	Nepali	8475	Turkmen
6779	Corsican	7384	Italian	7876	Dutch	8476	Tagalog
6783	Czech	7387	Hebrew	7879	Norwegian	8479	Tonga
6789	Welsh	7465	Japanese	7982	Oriya	8482	Turkish
6865	Danish	7473	Yiddish	8065	Panjabi	8484	Tatar
6869	German	7487	Javanese	8076	Polish	8487	Twi
6890	Bhutani	7565	Georgian	8083	Pashto, Pushto	8575	Ukrainian
6976	Greek	7575	Kazakh	8084	Portuguese	8582	Urdu
6978	English	7576	Greenlandic	8185	Quechua	8590	Uzbek
6979	Esperanto	7577	Cambodian	8277	Rhaeto-Romance	8673	Vietnamese
6983	Spanish	7578	Kannada	8279	Rumanian	8679	Volapük
6984	Estonian	7579	Korean	8285	Russian	8779	Wolof
6985	Basque	7583	Kashmiri	8365	Sanskrit	8872	Xhosa
7065	Persian	7585	Kurdish	8368	Sindhi	8979	Yoruba
7073	Finnish	7589	Kirghiz	8372	Serbo-Croatian	9072	Chinese
7074	Fiji	7665	Latin	8373	Singhalese	9085	Zulu



Selecting Parental Control Rating Levels {DVD Only}

This is to prohibit playing of DVDs which are unsuitable for children. Some DVDs have the rating restriction function which enables parents to prevent children from playing discs. TV/DVD also include password setting functions to prevent children from changing the level.

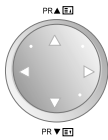

1 In the SETUP screen, press the [▲, ▼] button to select "Rating" and press the [▶] button.

Disc Audio	8
Disc Subtitle	7
Disc Menu	6
Rating	5
Password	4
TV Aspect	3
Menu Language	2
	1
Digital Audio Output	▶ Unlock
Others	



2 Press the [▲, ▼] button to select the desired level and press the [OK/ENTER] button.

Disc Audio	8	Blocked
Disc Subtitle	7	Blocked
Disc Menu	6	✓
Rating	5	
Password	4	
TV Aspect	3	
Menu Language	2	
	1	
Digital Audio Output		Unlock
Others		

NOTE

- You cannot play DVD video discs rated higher than the level you selected unless you release the parental lock. For example, when you select level 7, discs rated higher than level 7 cannot be played. (Higher rated means near to adult movie.)
- If you change the level and enter a password, playing all DVDs with ratings higher than your selection will be locked. If you want to change the rating again, you have to enter the correct password. For example: if you change the level to "5", the TV/DVD will not play discs with ratings of "6", "7", or "8". If you change the level again, you must enter the correct password.

Designating Password {DVD Only}

If you change the rating level to "7" or lower, you must enter a 4-number "password" to prevent playing discs with higher ratings.



- 1 In the SETUP screen, press the [▲, ▼] button to select "Password" and press the [▶] button.

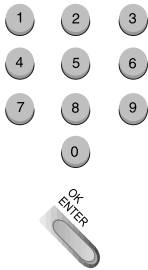
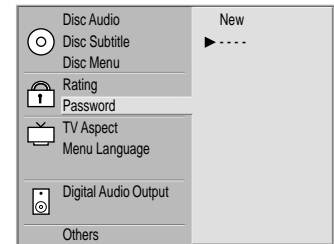

- 2 Press the [NUMBER] button to input a 4-number password and press the [OK/ENTER] button.

* Do not forget your password.

- 3 Input the 4-number password again and press the [OK/ENTER] button to verify.

* Setting has been completed.

■ To change/clear memorized password

- 1 In the SETUP screen, press the [▲, ▼] button to select "Password" and press the [▶] button.
- 2 Press the [NUMBER] button to input a 4-number password and press the [OK/ENTER] button.
- 3 To change or clear your password, select the "Change" or "Clear" and press the [OK/ENTER] button.

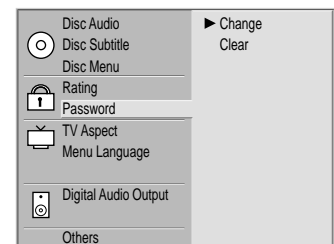

■ If you forget your memorized password,

- 1 In the SETUP screen, press the [▼] button to select "Password".
- 2 Enter 6-digit number "210499" and press the [OK/ENTER] button. The 4-number password is cleared.
- 3 Enter a new password.



Selecting TV Aspect

Select the appropriate screen type according to your TV set: 4:3 or 16:9.



1 In the SETUP screen, press the [**▲**, **▼**] button to select "TV Aspect" and press the [**▶**] button.

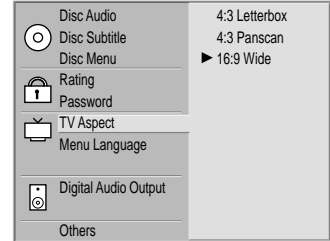

2 Press the [**▲**, **▼**] button to select the desired Aspect and press the [**OK/ENTER**] button.

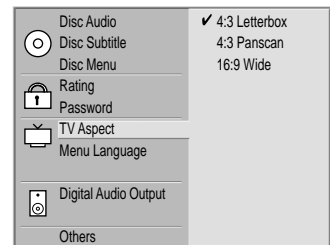

4:3 Letterbox

The video material not formatted in the Pan & Scan style is played in the letterbox style. Black bands appear at top and bottom of screen.

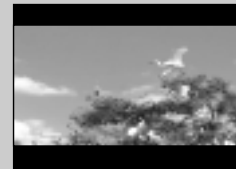

4:3 Panscan

Select when a conventional TV set is connected. The video material formatted in the Pan & Scan style is played in such a style. (For screen formatted in 16:9, then only the centre part of screen can be displayed).



16:9 Wide

Select when a wide-screen TV set is connected. The picture is played in full screen. (The wide-screen TV is also required to be set to "FULL".)



Selecting Menu Language

It is for selecting DVD menu language and the language which displays on the TV.

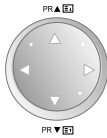

- 1** In the SETUP screen, press the [**▲**, **▼**] button to select "Menu Language" and press the [**▶**] button.



- 2** Press the [**▲**, **▼**] button to select the desired language and press the [**OK/ENTER**] button.





Selecting Digital Audio Output

Each DVD disc has a variety of audio output options.



1 In the SETUP screen, press the [**▲**, **▼**] button to select “Digital Audio Output” and press the [**▶**] button.

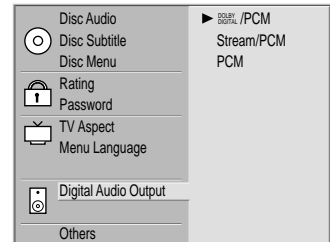

2 Press the [**▲**, **▼**] button to select the desired digital audio output and press the [**OK/ENTER**] button.

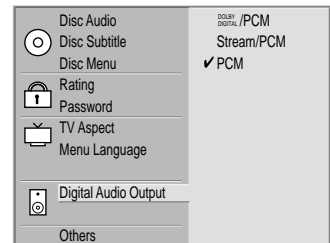

- DOLBY DIGITAL/PCM**
 Select “DOLBY DIGITAL/PCM” if a digital output is supplied to a Dolby Digital decoder (or an amp or other equipment with Dolby Digital decoder).
- Stream/PCM**
 Select “Stream/PCM” if a digital output is supplied to an amp or other equipment with DTS decoder, Dolby Digital decoder and MPEG decoder.
- PCM**
 Select “PCM” if a digital output is supplied to an amp or other equipment with PCM only (or MD recorder or DAT deck).

NOTE

- If a digital audio output signal is supplied to a receiver or other equipment without a corresponding digital decoding capability, a very loud noise may be produced which could permanently damage the speakers.
- The DTS DVD disc sound is played only when the TV/DVD is connected to an amp with a DTS decoder.

Play disc	Output		
	Stream/PCM	Dolby Digital/PCM	PCM only
96kHz Linear PCM DVD	PCM	PCM	PCM
DTS DVD	DTS bit stream	No Output	No Output
Dolby Digital DVD	Dolby Digital bit stream	Dolby Digital bit stream	PCM
MPEG DVD	MPEG bit stream	PCM	PCM
Audio CD/Video CD	PCM	PCM	PCM
DTS Audio CD	DTS bit stream	DTS bit stream	DTS bit stream

Others

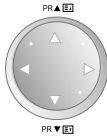

1 In the SETUP screen, press the [▲, ▼] button to select "Others" and press the [▶] button.

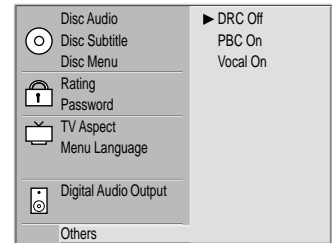

2 Press the [▲, ▼] button to select the desired item and press the [OK/ENTER] button.

■ DRC (Dynamic Range Compression)

What is DRC (Dynamic Range Compression)?

It is also called "Midnight Mode". It can decrease the difference between the loudest and the softest tone and prevent sudden loud tone. Therefore, you can get the soft voice clearly without disturbing others at night.

On: It compresses the dynamic range.

Off: It outputs the dynamic range as it originally was.

■ PBC (PlayBack Control)

On: Menu mode works when playing a disc with PBC function (Video CD version 2.0).

Off: Menu mode does not work when playing a disc with PBC function (Video CD version 2.0).

NOTE





- The DRC function works only during playing the Dolby Digital DVD discs.
- The level of Dynamic Range may differ depending on the DVD disc.

About DVD



Playable Disc

This TV/DVD can play the following discs.

Type	Disc mark	Contents	Disc size	Maximum playback time
DVD video discs		Audio+Video	12cm	Approx. 4 hours (single sided disc)
				Approx. 8 hours (double sided disc)
			8cm	Approx. 80 minutes (single sided disc)
				Approx. 160 minutes (double sided disc)
video CDs		Audio+Video	12cm	Approx. 74 minutes
			8cm	Approx. 20 minutes
Music CDs		Audio	12cm	Approx. 74 minutes
			8cm	Approx. 20 minutes
MP3		Audio	12cm	Approx. 160 minutes

In addition, this unit can play back a CD-R and CD-RW disc. You cannot play back discs other than those listed above (CD-ROM, CD-EXTRA, CD-G, photo CD, and CD-i discs cannot be played on this TV/DVD.) This TV/DVD is manufactured to adopt the PAL/SECAM colour broadcasting system in operation, but it can also play back NTSC-type DVD video discs.

Region Number

TV/DVD and DVD discs are marked for the Region number to be played in the relevant country. Only if the Region number described on the DVD disc corresponds to the Region number of this TV/DVD, this TV/DVD can play that disc. The Region number of this TV/DVD is 2. Please use only discs whose Region number is 2 or is not limited to the Regional Restriction (ALL). Otherwise, this TV/DVD does not work.



(Region Number 2)



(No Regional Restriction)

Notes on Copyright

This product incorporates copyright protection technology that is protected by method claims of certain U.S. patents and other intellectual property rights owned by Macrovision Corporation and other rights owners. Use of this copyright protection technology must be authorized by Macrovision Corporation, and is intended for home and other limited viewing uses only unless otherwise authorized by Macrovision Corporation. Reverse engineering or disassembly is prohibited.

Discs

Always...

- handle your discs with care.
Hold a disc with fingers on the border or hole,

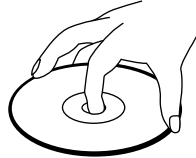

- place disc with the label facing upward (in case of a single-sided disc),
- place the disc properly into the tray using the proper guide area,
- use a soft cloth to clean discs if necessary, wipe from the centre to the border,
- always put discs back into their cases after playing and store in a vertical position.

Never...

- never close the tray with two discs on it or with a disc slipping out of the guide area,
- never play cracked, chipped or deformed discs nor try to repair them with adhesive tape or glue,
- never write on the disc,
- never move the player during playback,
- never scratch discs or store them in places of direct sunlight, high humidity or high temperature,
- never try to play a Photo CD , CD-G or CD-i in this TV/DVD.
- never use record cleaning sprays, benzene, static electricity liquids or any other solvent, if the disc surface is dirty.
- Wipe gently with a soft damp (water only) cloth, never wipe the disc in a circular motion, since circular scratches are likely to occur and could cause noise during playback.

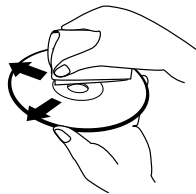

If you hear strange noises or vibrations coming out of the unit once a disc has started to play, rapidly press the STOP button of the remote control or front of player.

Before Calling Service Personnel

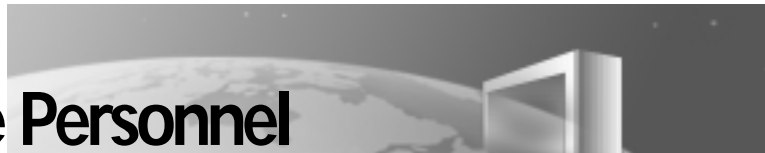

Symptoms	Correction
<ul style="list-style-type: none"> • Colour is not displayed and net pattern is displayed on the specific channel. 	<ul style="list-style-type: none"> ➤ Check the external antenna and cable TV conditions. ➤ Check whether you select the correct channel.
<ul style="list-style-type: none"> • Vertical and horizontal line and net pattern are displayed on the screen in a moment. Vibration is also displayed. 	<ul style="list-style-type: none"> ➤ Check the interference wave caused by car, neon sign, and high frequency. ➤ Check the strong interference radio wave from wave of other devices or radio station. Please stop the use of mobile phone, hair dryer, and electric drill.
<ul style="list-style-type: none"> • Pictures are overlapped and white and black spots are displayed 	<ul style="list-style-type: none"> ➤ Check damage of antenna or connection of antenna cable. ➤ Check the height and direction of antenna. If it is incorrect, please adjust the antenna.
<ul style="list-style-type: none"> • The original colours are not displayed in a screen in specific areas. 	<ul style="list-style-type: none"> ➤ Remove from magnetic fields or rotate set until purity error disappears.
<ul style="list-style-type: none"> • Picture is displayed irregularly. 	<ul style="list-style-type: none"> ➤ Check the connection of antenna cable (incorrect connection or disconnection). ➤ Move this product to another location.
<ul style="list-style-type: none"> • No picture and sound 	<ul style="list-style-type: none"> ➤ Plug the power cord into the wall outlet securely. ➤ Press the [TV/AV/DVD] button to change input mode.
<ul style="list-style-type: none"> • No sound 	<ul style="list-style-type: none"> ➤ [] button may be pressed. ➤ Check the volume.
<ul style="list-style-type: none"> • The remote control does not work properly 	<ul style="list-style-type: none"> ➤ Check a stoppage of power supply ➤ Check whether the power cord is plugged into the wall outlet. ➤ The batteries in remote control may be exhausted or loaded in wrong polarity. ➤ Check whether the remote control is too far from the player and is not pointed at the remote sensor of the player.
<ul style="list-style-type: none"> • The playback picture is poor 	<ul style="list-style-type: none"> ➤ Check the contamination of a disc and clean the disc.
<ul style="list-style-type: none"> • The DVD player does not start playback 	<ul style="list-style-type: none"> ➤ Insert a disc. ➤ Insert a playable disc. Check the disc type, colour system and Region code. ➤ Place the disc with the playback side down. ➤ Place the disc on the disc tray correctly inside the guide. ➤ Check the contamination of a disc and clean the disc. ➤ Press the [MENU] button to turn off the menu screen. ➤ Cancel the Rating function or change the rating level.

Free Manuals Download Website

<http://myh66.com>

<http://usermanuals.us>

<http://www.somanuals.com>

<http://www.4manuals.cc>

<http://www.manual-lib.com>

<http://www.404manual.com>

<http://www.luxmanual.com>

<http://aubethermostatmanual.com>

Golf course search by state

<http://golfingnear.com>

Email search by domain

<http://emailbydomain.com>

Auto manuals search

<http://auto.somanuals.com>

TV manuals search

<http://tv.somanuals.com>