

Microwave Oven

Use and Care Manual

KOT-170SW / KOT-170SB / KOT-172S

Table of Contents

Introduction	1
Precautions to Avoid Possible Exposure to Excessive Microwave Energy	1
Important Safety Instructions	2~3
Installation Recommendations.....	4
Control Panel.....	5~6
Oven Features at a Glance	7
Operating Basics	8~12
Special Features.....	12~17
Care and Cleaning	18~20
Questions and Answers	21
Before You Call.....	22
Warranty.....	23

IMPORTANT SAFETY INSTRUCTION

Never operate the oven when it is empty or without the glass turntable.

Introduction

Congratulations on your purchase of an over-the-range microwave oven. For best results, we suggest reading this guide carefully. You will find instructions on the proper operation and maintenance of your microwave.

PRECAUTIONS TO AVOID POSSIBLE EXPOSURE TO EXCESSIVE MICROWAVE ENERGY

- A. Do not** attempt to operate this oven with the door open since open-door operation can result in harmful exposure to microwave energy. It is important not to defeat or tamper with the safety interlocks.
- B. Do not** place any object between the oven front face and the door or allow soil or cleaner residue to accumulate on sealing surfaces.
- C. Do not** operate the oven if it is damaged. It is particularly important that the oven door close properly and that there is no damage to the: (1) door (bent), (2) hinges and latches (broken or loosened), (3) door seals and sealing surfaces.
- D.** The oven should not be adjusted or repaired by anyone except properly qualified service personnel.

IMPORTANT SAFETY INSTRUCTIONS

When using electrical appliances, basic safety precautions should be followed, including the following:

▲ WARNING - To reduce the risk of burns, electric shock, fire, injury to persons or exposure to excessive microwave energy:

1. Read all instructions before using the appliance.
2. Read and follow the specific "PRECAUTIONS TO AVOID POSSIBLE EXPOSURE TO EXCESSIVE MICROWAVE ENERGY" found on page 1.
3. This appliance must be grounded. Connect only to properly grounded outlet. See "GROUNDING INSTRUCTIONS" on page 4.
4. Install or locate this appliance in accordance with the provided installation instructions. Do not mount over a sink.
5. **This over-the-range oven was designed for use over ranges no wider than 30 inches.** It may be installed over both gas and electric cooking equipment.
6. **For best operation, plug this appliance into its own electrical outlet, to prevent flickering of lights, blowing of fuse or tripping of circuit breaker.**
7. Some products such as whole eggs and sealed containers - for example, closed jars - are able to explode and should not be heated in this oven. In rare instances, poached eggs have been known to explode. Cover poached eggs and allow standing time of one minute before cutting into them.
8. Foods with unbroken outer "skin" such as potatoes, sausages, tomatoes, apples, chicken livers and other giblets, and egg yolks (see previous caution) should be pierced to allow steam to escape during cooking. "Boilable" cooking pouches and tightly closed plastic bags should be slit, pierced or vented.
9. Do not heat, store or use flammable materials in or near the oven. Fumes can create a fire hazard or explosion.
10. Use this appliance only for its intended use as described in this manual. Do not use corrosive chemicals or vapors in this appliance. This type of oven is specifically designed to heat, cook or defrost food. It is not designed for industrial, laboratory or commercial use. It is intended for home use only.
11. As with any appliance, close supervision is necessary when used by children.
12. Do not operate this appliance if it has a damaged cord or plug, if it is not working properly or if it has been damaged or dropped.
13. This appliance should be serviced only by qualified service personnel. Contact nearest authorized service facility for examination, repair or adjustment.
14. Do not cover or block any openings on the appliance.
15. Do not use or store this appliance outdoors. Do not use this product near water - for example, near a kitchen sink, in a wet basement or near a swimming pool, or similar locations.
16. Do not immerse cord or plug in water.
17. Keep cord away from heated surfaces.
18. Do not let cord hang over edge of table or counter.
19. When cleaning surfaces of door and oven that come together on closing the door, use only mild, non-abrasive soaps or detergents applied with a sponge or soft cloth.
20. To reduce the risk of fire in the oven cavity:
 - a. Do not overcook food. Carefully attend appliance when paper, plastic or other combustible materials are placed inside the oven to facilitate cooking. Avoid using recycled paper products. Do not use newspaper or other printed paper in the oven. Such products sometimes contain impurities which could ignite.
 - b. Remove wire twist-ties from paper or plastic bags before placing them in oven.
 - c. If materials inside the oven ignite, keep oven door closed, turn oven off and disconnect the power cord or shut off power at the fuse or circuit breaker panel.
 - d. Do not use the oven for storage. Do not leave paper products, cooking utensils or food in the oven when not in use.
 - e. Do not pop popcorn except in a microwave approved popcorn popper or in a commercial package recommended especially for microwave ovens.
 - f. Do not overcook potatoes. They may dehydrate and catch fire.
 - g. Do not use for drying clothes, linens, newspaper or similar non-food type items.
21. **Do not operate the oven when empty or with an empty utensil to avoid damage to the oven and danger of fire.**
22. Do not lean on the oven door. The door is designed to close tightly and seal properly for safe operation. Leaning on the door may warp or break the hinges.

IMPORTANT SAFETY INSTRUCTIONS cont.

23. To avoid exposure to dangerous high voltage, **DO NOT REMOVE THE SPLATTER SHIELD** inside the oven cavity.
24. Liquids, such as water, coffee, or tea are able to be overheated beyond the boiling point without appearing to be boiling due to surface tension of the liquid. Visible bubbling or boiling when the container is removed from the microwave oven is not always present. **THIS COULD RESULT IN VERY HOT LIQUIDS SUDDENLY BOILING OVER WHEN A SPOON OR OTHER UTENSIL IS INSERTED INTO THE LIQUID.** To reduce the risk of injury to persons:
- ① Do not overheat the liquid.
 - ② Stir the liquid both before and halfway through heating it
 - ③ Do not use straight-sided containers with narrow necks.
 - ④ After heating, allow the container to stand in the microwave oven for a short time before removing the container.
 - ⑤ Use extreme care when inserting a spoon or other utensil into the container.
25. **Read and follow specific microwave oven preparation instructions on food packages or containers (especially baby food). Above all, this is a cooking appliance designed to prepare food.**
26. Use only cooking utensils and accessories made for use in the microwave and specifically described in this manual.
27. Microwave oven manufacturers do not recommend deep fat frying or frying in a microwave oven. Hot oil can damage oven parts and utensils and even result in skin burns.
28. Plastic wrap : Use only those types designed for microwave oven use and avoid forming an air-tight seal. Fold back a small corner or cut a small slit to allow steam to escape.
29. Stay near the appliance while it is in use and check cooking progress frequently. Leaving the appliance unattended may result in overcooked food and possibly a fire in your oven.
30. **Foods cooked in liquids** (such as pasta) may tend to boil over more rapidly than foods containing less moisture. Should this occur, refer to the Care and Cleaning section for instructions on how to clean the inside of the oven.
31. Do not use a thermometer in food you are microwaving unless the thermometer is designed or recommended for use in the microwave oven.
32. Plastic cookware designed for microwave cooking is very useful, but should be used carefully. Even microwave-safe plastic may not be as tolerant of overcooking conditions as are glass or ceramic materials and may soften or char if subjected to short periods of overcooking. In longer exposures to overcooking, the food and cookware could ignite. For these reasons: 1) Use microwave-safe plastics only and use them in strict compliance with the cookware manufacturer's recommendations. 2) Do not subject empty cookware to microwaving. 3) Do not permit children to use plastic cookware without complete supervision.
33. **Do not store anything directly on top of the microwave oven surface when the oven is in operation.**
34. TV dinners may be microwaved in foil trays less than 3/4" deep; remove top foil cover and return tray to box. When using metal in microwave oven, keep metal at least 1 inch away from the sides of the oven.
35. Do not defrost frozen beverages in narrow necked bottles.
36. Cookware may become hot because of heat transferred from the heated food. Potholders may be needed to handle the cookware.
37. Do not try to melt paraffin wax in the oven. Paraffin wax will not melt in a microwave oven because it allows microwaves to pass through it.
38. Never use sharp-edged utensils in or near the oven.
39. Hot foods and steam can cause burns. Be careful when opening containers of hot food, including popcorn bags, cooking pouches and boxes. To prevent possible injury, direct steam away from hands and face.
40. Clean the vent hood often. Do not allow grease to build up on the hood or the filter.
41. Use care when cleaning the vent hood filter. Corrosive cleaning agents, such as lye-based oven cleaners, may damage the filter.
42. When flaming foods are under the hood, **turn the fan off.** The fan, if operating may spread the flame.

SAVE THESE INSTRUCTIONS

Installation Recommendations

Remove all packing materials both outside and inside the oven before using the oven. The oven requires free movement of air for proper operation. Do NOT block air vents located by the top air grill and underneath the oven.

Grounding Instructions

This appliance must be grounded. In the event of an electrical short circuit, grounding reduces the risk of electric shock by providing an escape wire for the electric current. This appliance is equipped with a cord having a grounding wire with a grounding plug. The plug must be plugged into a 120v, 15amp. outlet that is properly installed and grounded.

▲ WARNING - Improper use of the grounding plug can result in a risk of electric shock.

Consult a qualified electrician or service technician if the grounding instructions are not completely understood or if doubt exists as to whether the appliance is properly grounded.

Where standard two-prong wall receptacle is encountered, it is your personal responsibility and obligation to have it replaced with a properly grounded three-prong wall receptacle.

Do not under any circumstance cut or remove the third (ground) prong from the power cord. Do not use an adapter plug with this appliance. See pages 1 and 2 of the Installation Manual for acceptable extension cord specifications.

Interference Note

Microwave ovens generate radio frequency energy during operation and if not installed properly may cause interference to radio and television reception. You can determine if this unit is causing interference by turning it on and off while the interference is occurring. If interference occurs, it may be corrected by one or more of the following measures:

- ◆ clean door and seal surfaces of the oven;
- ◆ reorient the television or radio receiving antenna;
- ◆ the oven with respect to the television or radio receiver, and/or
- ◆ Plug the oven into a different outlet so that it and the television or radio receiver are on different circuits.

If the interference persists, you may want to consult an experienced radio/television technician for additional

Automatic Fan Protection feature

Cooking appliances installed under the microwave oven may, under some heavy usage conditions, cause temperatures high enough to overheat some internal parts of the microwave oven.

To prevent overheating from taking place, the exhaust fan is designed to automatically turn on at a low speed if

excessive temperatures occur. Should this happen, the fan cannot be manually turned off, but it will automatically turn off when the internal parts have cooled. The fan may stay on for up to an hour after the range and microwave oven controls have been turned off.

Microwaving Tips

- ◆ Make sure all cookware used in your microwave oven is suitable for microwaving. Most glass cooking dishes, measuring cups, custard cups, pottery or china dinnerware, which does not have metallic trim or glaze with metallic sheen, can be used.
- ◆ If you are not sure if a dish is microwave-safe, use this test: Place in the oven the dish you are testing and a glass measuring cup filled with one cup of water. Set the measuring cup either in or next to the dish.

Microwave 1 minute at high. If the dish heats, it should not be used for microwaving. If the dish remains cool and only the water in the cup heats, then the dish is microwave-safe.

- ◆ Paper towels, waxed paper and plastic wrap can be used to cover dishes in order to retain moisture and prevent spattering. Be sure to vent plastic wrap so steam can escape.

Touch Control Panel

The Touch Control Panel allows you to set the oven controls with the touch of a finger. It's designed to be easy to use and understand.

1. **DISPLAY WINDOW** - Displays time of day, time or temperature during cooking functions, power level being used, cooking mode and instructions.
2. **POPCORN** - Touch this pad to cook prepackaged microwave popcorn weighing 1.75 or 3.5 ounces. The oven will start automatically. (Page 12)
3. **BEVERAGE** - Touch this pad to reheat a beverage. The oven will start automatically. (Page 13)
4. **FROZEN VEGETABLE** - Touch this pad to cook frozen vegetables. The oven will start automatically. (Page 14)
5. **FAVORITE CHOICE** - Touch this pad to recall three cooking instructions placed in memory and to program sound level of signals, scroll speed and disable clock display. (Page 13)
6. **BAKED POTATO** - Touch this pad to cook 1-4 potatoes. The oven will start automatically. (Page 13)
7. **DINNER PLATE** - Touch this pad to reheat a dinner plate full of chilled leftovers. (Page 13)
8. **FROZEN PIZZA** - Touch this pad to heat frozen pizza. The oven will start automatically. (Page 13)
9. **SNACK** - Touch this pad to warm a variety of snack foods by means of the automatically preset microwave power and cook time. (Page 15)
10. **SENSOR COOK** - Will automatically compute the microwave power and cook time. Refer to Sensor Cook Guide. (Page 14)
11. **COOK TIME** - Microwave for a selected amount of time.
 - ◆ Power Level 10 (High) is automatic but lower heat levels may be programmed. (Page 8)
12. **AUTO DEFROST** - Touch this pad and enter food weight, then **START**. The oven automatically sets power levels and defrosting time. (Page 10)
13. **ADD MINUTE** - Touch this pad for 1 minute of cook time, to add 1 minute of cook time as the timer is counting down or for an "instant on" for 1 minute. (Page 9)
14. **POWER** - Touch this pad if you want to change from automatic Power Level 10 (High) for cooking. (Page 8-9)
15. **NUMBER PADS** - Touch these pads to enter cooking time, defrosting time, time of day, power level or food weights for Auto Defrost.
16. **WARM** - Touch this pad and safely keep food warm for up to 30 minutes. (Page 13)
17. **TIMER** - This feature uses no microwave energy. It functions as a kitchen timer, as a holding period after defrost or as a delay timer before time cooking. (Page 9)
18. **DISPLAY (Multi-Language)** - Touch this pad to select the user a language. (Page 16)
19. **TURNTABLE** - Touch this pad to turn the turntable on and off. (Page 16)
20. **HELP** - Touch this pad if you want to know the feature of key pad on the control panel. (Page 16)
21. **CANCEL/OFF** - When touched once, it pauses the oven operation. When touched twice, it shuts off the oven and erases all settings (except time of day).
22. **CLOCK** - Touch this pad to enter time of day or check time of day while microwaving. (Page 8)
23. **START** - After all selections are made, touch this pad to start the oven or timer.
24. **VENT FAN** - Touch this pad if you want to know the feature of key pad on the control panel. (Page 17)
25. **LIGHT** - Touch this pad to turn on or off the surface light and night light. (Page 17)

<KOT-172S>



<KOT-170SW, KOT-170SB>

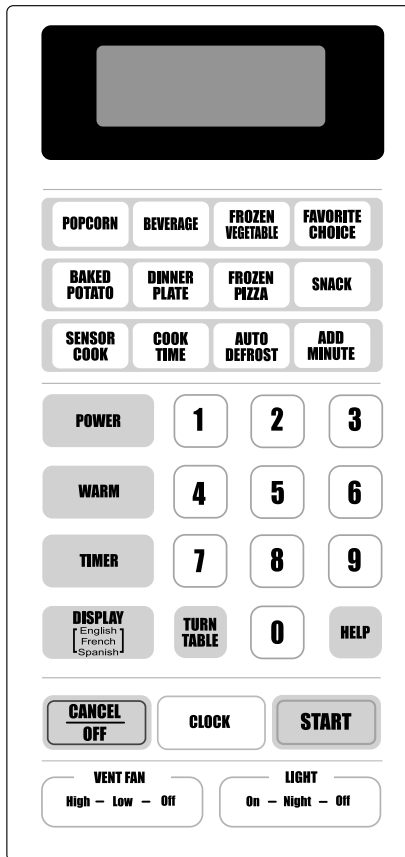

- ◆ When you plug in the oven, the display will scroll “ TOUCH CLOCK PAD TO ENTER TIME OF DAY”. If power is disrupted at any time, the above sequence recurs.
- ◆ Each time a pad is touched, a BEEP will sound.
- ◆ When **CANCEL/OFF Pad** is touched during oven operation, the oven will stop, however, all programmed information is retained. To clear all information, touch the **CANCEL/OFF Pad** again.

NOTE: Styling and features may differ slightly depending on model.

Oven Features at a Glance

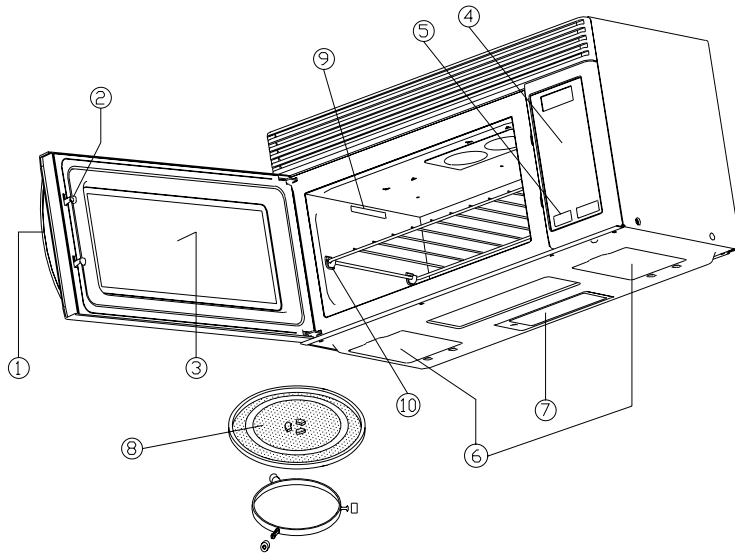

1. DOOR HANDLE - Pull to open door. Door must be securely latched for oven to operate.

2. DOOR LATCHES

3. WINDOW with METAL SHIELD - Screen allows cooking to be viewed while keeping microwaves confined in oven.

4. TOUCH CONTROL PANEL and DIGITAL DISPLAY - For detailed information on each feature, see Touch Control Panel section, page 5.

5. HOOD CONTROLS

Vent Fan - Press High, Low or Off

Light - Press On, Night or Off

6. GREASE FILTERS

7. COOKTOP LIGHT

8. TURNTABLE - Composed of glass tray and roller guide. The roller guide is placed first in the bottom of the microwave and supports the glass tray. **Both parts must be in place when using the microwave oven.**

9. DATA PLATE - Located on the inside wall of the microwave oven.

10. OVEN SHELF - May be used when cooking more than one item at a time.

Operating Basics

Time-of-Day Clock

Basic Instructions

1. Touch the **CLOCK Pad**. "CLOCK ENTER TIME" Will be displayed.
2. Set the time of day by touching the appropriate numbers. The selected time appears and "PRESS CLOCK AGAIN" will be displayed.
3. Touch the **CLOCK Pad** again. The colon will flash.

- ◆ After plugging in the oven or after a power outage, the **Display** will scroll "TOUCH CLOCK PAD TO ENTER TIME OF DAY". Touch the **CANCEL/OFF Pad** and set the clock following the directions above.
- ◆ The "time-of-day" clock is a 12 hour clock.
- ◆ If set, the time of day will always be displayed when no other cooking function is being used.
- ◆ The time of day returns to the current time when the oven turns off.

Cook Time/Power Level

Basic Instructions

1. Touch the **COOK TIME Pad**. "ENTER COOKING TIME" Will be displayed.
2. Enter the cooking time by using the number pads.

For example, for 5 minutes touch number 5,0,0. The selected time and "PRESS START" will be displayed.

3. Touch the **START Pad** again. "COOK TIME" and selected time will be displayed.

- ◆ The cooking time will appear in the Display window.
- ◆ The oven will start cooking and time countdown will begin.
- ◆ The oven will stop automatically when the time is done and beep three times.
- ◆ When the cook time ends, "END COOK" appears in the Display.

- ◆ Start with the shortest recommended time and add more time as needed.
- ◆ Check the food as it cooks.
- ◆ The oven door can be opened any time during operation. It will automatically stop and maintain the time setting until the door is closed and the **START Pad** is touched again.
- ◆ If the **START Pad** is touched and the oven does not operate, check the area between the door and door seal for obstructions. The oven will not start until the door is completely closed.

Note . . .

- ◆ *Full power is automatic. If you wish to use a different power level, touch the **POWER Pad** before touching **START Pad**. "POWER LEVEL IS HI [10]. TOUCH 1-9 FOR NEW POWER LEVEL. PRESS START" will be displayed. Enter the power level desired by touching the appropriate number pad. The selected power level and "PRESS START" will be displayed. (See **Cooking Guide on page 9**).*

Operating Basics

Power Level Cooking Guide

The power levels on your microwave oven can be compared to the surface units on a range. High (power level 10) or full power is the fastest way to cook and gives you 100% power.

Each power level gives you microwave energy for a certain percent of time, for example, power level 7 is microwave energy 70% of the time. Most of your cooking will be done on High (Power Level 10). a lower setting will cook more evenly and with less attention given to stirring or rotating the food. Some foods may have better flavor, texture or appearance if one of the lower settings is used. You may wish to use a lower power level when cooking foods that have a tendency to boil over, such as scalloped potatoes. Cooking times will increase as power level decreases.

Power Level	Best Uses
High 10	Fish, bacon, vegetables, boiling liquids.
Medium 7	Gentle cooking of meat and Poultry, baking casseroles and reheating.
Medium 5	Slow cooking and tenderizing for stews and less tender cuts of meat.
Low 3	Defrosting, simmering, delicate sauces.
Warm 1	Keeping food warm without overcooking, softening butter.

Add Minute

The **ADD MINUTE Pad** provides a convenient way to heat foods at full power with one touch of a pad or add an extra minute to your cooking cycle while in progress.

The microwave starts automatically after the pad is touched.

Basic Instructions

1. Touch the **ADD MINUTE Pad**. The **Display** will show "PRESS AGAIN TO ADD MIN".

ADD MINUTE cannot be used with **ONE TOUCH COOKING FUNCTIONS, SENSOR COOK, AUTO DEFROST, TIMER, FAVORITE CHOICE** or **WARM**. Each time the pad is touched the oven will add 1 minute to the time up to 99 minutes.

Timer

Basic Instructions

1. Touch the **TIMER Pad**. The **Display** will show "ENTER TIME".
2. Enter desired time. The **Display** will show the selected time and "PRESS START".
3. Touch the **START Pad**. The **Display** will show "TIMER" and selected time.

- ◆ The timer can be programmed up to 99 minutes and 99 seconds.
- ◆ Three beeps signal the end of the timing operation.
- ◆ To stop the timer once it has started, touch the **CANCEL/OFF Pad** twice. Display will return to the time of day or cooking program.
- ◆ The timer cannot be set while cooking.
- ◆ The door must be shut for the timer to operate.

Auto Defrost

Use the defrost setting for defrosting meats, poultry and fish from 0.5 pounds to 6.5 pounds.

Basic Instructions

1. ♦ Touch the **AUTO DEFROST Pad** once for meat. "MEAT DEFROST ENTER FOOD WEIGHT IN LBS" Will be displayed.
 - ♦ Touch the AUTO DEFROST Pad twice for poultry. "POULTRY DEFROST ENTER FOOD WEIGHT IN LBS" will be displayed.
 - ♦ Touch the AUTO DEFROST Pad three times for fish. "FISH DEFROST ENTER FOOD WEIGHT IN LBS" will be displayed.
2. Touch number pads to enter the weight. *The defrosting time and power levels are automatically calculated.
3. Touch the **START Pad**. "DEFROST TIME" and time appear in the **Display**.

* Enter the weight in pounds and tenths of a pound. See Conversion Chart below.

- ♦ During defrosting, the oven will beep a series of short beeps to signal that the food needs to be turned or rearranged. "TURN FOOD OVER" will be displayed. Oven will continue operation if food is not turned or rearranged. Three beeps signal the end of defrosting. "END DEFROST" appears in the **Display**.
- ♦ During defrosting meat and fish, the food needs to be turned or rearranged twice. During defrosting poultry, the food needs to be turned or rearranged once.

Conversion Chart

If weight is in ounces-	then weight is converted to tenths-of-a-pound.
1 to 2-oz.	0.1
3 to 4-oz.	0.2
5-oz.	0.3
6 to 7-oz.	0.4
8-oz.	0.5
9 to 10-oz.	0.6
11 to 12-oz.	0.7
13-oz.	0.8
14 to 15-oz.	0.9

10

Defrost by Time

Basic Instructions

1. Touch the **TIME Pad**. "ENTER COOKING TIME" Will be displayed.
2. Enter defrosting time desired.
3. Touch the **POWER Pad**. "POWER LEVEL IS HI [10]" will be displayed.
4. Touch **NUMBER "3" Pad**. "PL-30 PRESS START" will be displayed.
5. Touch the **START Pad**.

Note . . .

- ♦ Three short beeps indicate an incorrect entry.
- ♦ See page 11 for additional defrosting tips for both Auto and Time Defrost.

Operating Basics

Defrost by Time Guide (Power Level 3)

Items and Weight Time	Defrosting Time	Standing	Procedures and Techniques
Beef Ground Beef/1 lb. Ground Beef/2 lbs. Beef Roast, boneless/3 lbs. Steaks/1" thick	10-12 min. 18-20 min. 26-28 min. 7-8 min.	5 min. 8-12 min. 7-10 min. 5-7 min.	Break apart and remove thawed portions with fork. Break apart and remove thawed portions with fork. Turn over part way. Shield ends or thinner areas with foil. Separate and rearrange once.
Pork Pork Roast, boneless/3 lbs. Pork Chops/1 lb Ground Pork/1 lb. Spareribs/1 1/2 lbs.	20-22 min. 7-8 min. 10-12 min. 15-16 min.	10-15 min. 5-7 min. 5-7 min. 5-7 min.	Turn over part way. shield ends or thinner areas with foil. Separate and rearrange once. Break apart and remove thawed portions with fork. Turn meat over and rearrange, separate once.
Poultry Whole Chicken/3 lbs. Chicken Breasts boneless/1 lb. Chicken Thighs/2 lbs.	20-22 min. 7-8 min. 18-23 min.	10-15 min. 5-7 min. 8-13 min.	Turn chicken over. shield wing tips, leg ends and breast areas with foil. Breast side down. Separate and rearrange once. Separate and rearrange once.
Fish Fish Fillets/1 lb.	10-11 min.	5-7 min.	Separate and rearrange once. Shield as needed.

General Defrosting Tips

- Do not defrost covered meat. Covering might allow cooking to take place. Always remove outer wrap and tray. Place food on a microwave-safe rack in a dish.
- Begin defrosting whole poultry breast-side-down. Begin defrosting roasts fat-side-down.
- The shape of the package alters the defrosting time. Shallow rectangular shapes defrost more quickly than a deep block.
- Auto Defrost is programmed for specific weights. Defrost results will be affected if you enter an incorrect weight.
- Auto Defrost is programmed for frozen food at 0° F. If food is stored at a higher temperature, expect shorter defrost times.
- After 1/3 of the defrost time has elapsed, check the food. You may wish to turn over, break apart, rearrange or remove thawed portions of the food.
- During Auto Defrost, the oven will prompt you to turn the food over.** At this point, open oven door and check the food. Follow the techniques listed below for optimum defrost results. Then, close oven door, touch the START Pad to complete defrosting.
 - ◆ **Turn Over** : Roast, ribs, whole poultry, turkey breasts, hot dogs, sausages, steaks, or chops.
 - ◆ **Rearrange** : Break apart or separate steaks, chops, hamburger patties, ground meat, chicken or seafood pieces, chunks of meat such as stew beef.
 - ◆ **Shield** : Use small strips of aluminum foil to protect thin areas or edges of unevenly shaped foods such as chicken wings. To prevent arching, do not allow foil to come within 1-inch of oven walls or door.
 - ◆ **Remove** : To prevent cooking, thawed portions should be removed from the oven at this point. This may shorten defrost time for foods weighing less than 3-lbs.
- After defrosting, allow food to stand 5 to 10 minutes if there are any icy areas. If large solid roasts, such as sirloin tip or rump roasts, are not completely thawed after standing, return roast to oven and program **Auto Defrost** for 1 lb.

Two Stage Cooking

This feature lets you program two sequential operations such as defrosting and cooking or cooking

using two different power levels. It automatically changes power settings and cooking time.

Basic Instructions

1. Touch the **COOK TIME Pad**. "ENTER COOKING TIME" will be displayed.
2. Touch the appropriate number pads to enter the cooking time. The selected time and "PRESS START" will be displayed.
3. Touch the **POWER Pad**. *"POWER LEVEL IS HI [10]. TOUCH 1-9 FOR NEW POWER LEVEL---PRESS START"
4. Touch the number pad for the power level you desire. *The selected power level and "PRESS START" will be displayed.
5. Touch the **COOK TIME Pad** again. "ENTER SECOND COOKING TIME" will be displayed.
6. Touch the appropriate number pads to enter the cooking time for the second stage of cooking. The selected time and "PRESS START" will be displayed.
7. Touch the **POWER Pad**. *"POWER LEVEL IS HI [10]. TOUCH 1-9 FOR NEW POWER LEVEL---PRESS START" will be displayed.
8. Touch the number pad for the power level you desire. * The selected power level and "PRESS START" will be displayed.
9. Touch the **START Pad**.

- ◆ Three beeps signal the end of cooking. "END COOK" appears in the Display.
- ◆ The audible beep between stages can serve as a reminder to add foods or ingredients.

* Skip steps 3 and 4 or 7 and 8 if full power is desired.

Special Features

Popcorn

Basic Instructions

1. Touch the **POPCORN Pad** once for 3.5 oz. package. The **Display** will show "3.50 OZ BAG OF POPCORN" or
2. Touch the **POPCORN Pad** twice for 1.75 oz. package. The **Display** will show "1.75 OZ BAG OF POPCORN".

- ◆ The POPCORN Pad has been automatically set for the correct cook time for a 3.5 oz. or 1.75 oz. bag of popcorn.

- ◆ Listen as the popcorn pops and stop the microwave when the popping slows down to 3 seconds apart.
- ◆ Do not try to repop unpopped kernels or reuse a bag.
- ◆ Pop only one package at a time.

CAUTION: If prepackaged popcorn is a different weight than the recommended weight, do not use the **POPCORN Pad**. Inadequate popping or a fire may occur. Follow manufacturer's instructions.

Special Features

Dinner Plate

Basic Instructions

1. Touch the **DINNER PLATE Pad**. The **Display** will show "DINNER PLATE"

- ◆ The programmed time (2:40) will show in the **Display**.
- ◆ Place meat and dense vegetables to the outside of the plate.
- ◆ Place delicate foods in the center of the plate.
- ◆ Cover the plate with wax paper to hold steam around most foods except rare meats or vegetables with crisp exteriors.

Frozen Pizza

Basic Instructions

1. Touch the **FROZEN PIZZA Pad**. The **Display** will show "PIZZA"

- ◆ The programmed time (3:00) will show in the **Display**.
- ◆ Time set is for a 6.0-7.5 oz. pizza.
- ◆ Cook only one pizza at a time.
- ◆ Follow manufacturer's directions.
- ◆ Use only frozen pizza labeled microwaveable.
- ◆ If cheese pizza does not melt sufficiently, cook a few seconds longer.

Beverage

Basic Instructions

1. Touch the **BEVERAGE Pad** once for 1 cup (7 oz.)/mug. The **Display** will show "1CUP".
2. Touch the **BEVERAGE Pad** twice for 2 cups (14 oz.)/mugs. The **Display** will show "2CUPS".
3. Touch the **BEVERAGE Pad** three times for 3 cups (21 oz.)/mugs. The **Display** will show "3CUPS".

Baked Potato

Basic Instructions

1. Touch the **BAKED POTATO Pad**:
 - ◆ once for 1 medium potato (7 oz.)
 - ◆ twice for 2 medium potatoes (14 oz.)
 - ◆ three times for 3 medium potatoes (21 oz.)
 - ◆ four times for 4 medium potatoes (28 oz.)
 - ◆ The **Display** will show "1 EA POTATO", "2 EA POTATO", "3 EA POTATO" or "4 EA POTATO"

Warm

Basic Instructions

1. Touch the **WARM Pad**. The **Display** will show "WARM PRESS START".
2. Touch the **START Pad**.

- ◆ The microwave oven will safety keep cooked foods warm for up to 30 minutes.
- ◆ Opening the door or touching the **CANCEL/OFF Pad** cancels the **WARM** setting.
- ◆ Foods that were covered during cooking should be covered during warming.
- ◆ Complete meals on a dinner plate should be covered.

Favorite Choice

To Program Favorite choice Setting:

1. Touch the **COOK TIME Pad**. Enter cooking time.
2. Touch the **Power Pad**.
3. Enter power level. Example "5" for 50% power level.
4. Touch the **FAVORITE CHOICE Pad**.
5. Touch the **CANCEL/OFF Pad** to place in memory.

When a program has been entered, "MEMO" will appear in the **Display** to let you know that the program has been entered.

NOTE: Repeat steps 1-5 for **FAVORITE CHOICE Programs 2 and 3**.

To Change Favorite Choice Setting:

- ◆ Touch and hold **FAVORITE CHOICE Pad** for 3 seconds or until a beep sounds. **Display** shows "PROG-1". Previously set information will be erased.
- ◆ Follow previous steps 1-5 to program new settings.

To Use Favorite Choice:

1. Put food in oven and close door.
2. Touch **FAVORITE CHOICE Pad**. "PROG-1" will appear in the **Display**.
 - ◆ To select program 2 or 3 press **FAVORITE CHOICE Pad** until desired program number appears in the **Display**.
3. Touch the **START Pad**.

To Program Favorite Choice Signal Sound, Scroll Speed and Clock Display:

Touch **FAVORITE CHOICE Pad** four times “PROG-4 SELECT TYPE ENTER 1-6” will be displayed.

To Change Signal Sound:

- ◆ Touch number pad 1. “BUZZER ON” will be displayed. Touch **CANCEL/OFF Pad**.
- ◆ Touch number pad 2. “BUZZER OFF” and “MUTE” will be displayed. “MUTE” will remain in the **Display** until the buzzer is turned on. Touch **CANCEL/OFF Pad**.

To Change Scroll Speed:

- ◆ Touch number pad 3. “FAST SCROLL SPEED” will be displayed. Touch **CANCEL/OFF Pad**.
- ◆ Touch number pad 4. “NORMAL SCROLL SPEED” will be displayed. Touch **CANCEL/OFF Pad**.
- ◆ Touch number pad 5. “SLOW SCROLL SPEED” will be displayed. Touch the **CANCEL/OFF Pad**.

To Turn Clock Display On/Off:

- ◆ Touch number pad 6. Signal will sound and the **Display** will go blank. To recall the time of day, touch the **START Pad** and the current time of day will be displayed for 10 seconds.

Frozen Vegetable

Basic Instructions

1. Touch the **FROZEN VEGETABLE Pad** once for 8 oz. frozen vegetable. The **Display** will show “8 OZ FROZEN VEGETABLE”
2. Touch the **FROZEN VEGETABLE Pad** twice for 10 oz. frozen vegetable. The **Display** will show “10 OZ FROZEN VEGETABLE”.
3. Touch the **FROZEN VEGETABLE Pad** three times for 16 oz. frozen vegetable. The **Display** will show “16 OZ FROZEN VEGETABLE”.
4. Touch the **FROZEN VEGETABLE Pad** four times for 20 oz. frozen vegetable. The **Display** will show “20 OZ FROZEN VEGETABLE”.

Sensor Cook

Basic Instructions

1. Touch the **SENSOR COOK Pad** until the desired food is displayed. *
2. Touch the **START Pad**.

* See the following chart or the *Cooking Guide Label on the front of the oven cavity.*

- ◆ **SENSOR COOK** will automatically customize the cook time for food in four categories - soup, fresh vegetables, muffins and fish fillets.

Sensor Cook Guide

FOOD	TOUCH SENSOR COOK PAD	DISPLAY GUIDE	QUANTITY
Soup	Once	“SOUP PRESS START”	8-32 oz.
Fresh Vegetables	Twice	“FRESH VEGETABLE PRESS START”	4-16 oz.
Muffins	Three Times	“MUFFIN PRESS START”	2-8 ea.
Fish Fillets	Four Times	“FISH FILLETS PRESS START”	4-16 oz.

Cooking Tips and Techniques

- ◆ For best results, cover container with plastic wrap and turn back one edge of the wrap to form a 1/2-inch slot where steam can escape.
- ◆ After cooking fresh vegetables, allow 3-5 minutes of stand time before serving. This will allow the food to finish cooking without overcooking.
- ◆ When preparing fresh vegetables, add 1/2 cup of water per 1/2 pound of fresh vegetables.

Special Features

Snack

Basic Instructions

1. Touch the **SNACK Pad** until the desired food is displayed.*
2. Touch the number pad indicated on the Cooking Guide for the cooking weight desired.*
3. Touch the **START Pad**.

* See the following chart or the Cooking Guide Label on the front of the oven cavity.

- ◆ The SNACK feature automatically sets the microwaving times and power levels to warm a variety of snack foods.
- ◆ The DISPLAY counts down the cooking time.

Snack Cook Guide

FOOD TYPE	SNACK PAD	NUMBER PAD	QUANTITY OR WEIGHT
1. Bread	Once	1	1 EA
		2	2 EA
		3	3 EA
		4	4 EA
2. Sandwich	Twice	1	1 EA
		2	2 EA
3. Dessert Topping	Three Times	1	1 SERVINGS
		2	2 SERVINGS
		3	3 SERVINGS
		4	4 SERVINGS
4. Cheese Dip	Four Times	1	7 oz.
		2	11 oz.
		3	15 oz.
		4	19 oz.

Auto Start

The AUTO START feature allows you to program your oven to begin cooking at a preset time of day - up to a delay of 11 hours and 59 minutes. You can program two sequential operations using two different power levels.

Basic Instructions

1. Touch **COOK TIME Pad**.
2. Enter the cooking time.*
3. Touch the **POWER Pad**.
4. Enter the Power level.
5. Touch **COOK TIME Pad**.
6. Enter the cooking time.
7. Touch the **POWER Pad**.
8. Enter the power level.
9. Touch **CLOCK Pad**.
10. Enter the clock time you want the oven to start.
11. Touch the **START Pad****

* If you wish to cook with one Stage, omit steps 5,6,7 & 8.

** The oven will start cooking at the set time. If the door is opened before the start time is reached, touch the **START Pad** to resume the **AUTO START** option.

- ◆ The **AUTO START** feature cannot be used with the following option: **POPCORN, FROZEN PIZZA, BEVERAGE, FROZEN VEGETABLE, DINNER PLATE, BAKED POTATO, WARM, ADD MINUTE, TIMER, FAVORITE CHOICE, AUTO DEFROST, SNACK** and **SENSOR COOK**.
- ◆ Do not use foods containing baking powder or yeast when using **AUTO START**. They will not rise properly.
- ◆ **Warning:** Do not use foods that will spoil while waiting for cooking to start, such as dishes with milk or eggs, cream soups and cooked meats or fish. Any food that has to wait for cooking to start should be very cold or frozen before it is put in the oven. Unfrozen foods should never stand more than two hours before cooking starts. Do not allow food to remain in the oven for more than two hours after end of cooking cycle.

To Check Auto start Time:

Touch the **CLOCK Pad**. The programmed **AUTO START** time and "AUTO START COOKING TIME" will appear in the **Display**.

Tips on setting Auto Start:

- ◆ Before setting, check that the correct time of day is displayed.
- ◆ If you hear the fan start when you touch the **START Pad**, you have not set the oven properly. Touch the **CANCEL/OFF Pad** and start over.

More or Less Time Adjustment

You may increase or decrease any of the pre-set settings for the ONE TOUCH COOKING FEATURES except the SNACK feature if you prefer more or less cooking time.

To Adjust the Pre-set Settings:

1. Touch the **POWER Pad** once to increase the time by 20 seconds or twice to decrease the time by 20 seconds.
2. Touch the desired **ONE TOUCH COOKING Pad**.

Turntable On/Off

For best cooking results, leave the turntable on. When using larger dishes, it can be turned off.

- ◆ Press **TURNTABLE** Pad to turn the turntable on or off.
- ◆ Display will show the **T/T OFF** indicator light.
- ◆ **TURNTABLE** cannot be turned off with the following options: **POPCORN, BEVERAGE, BAKED POTATO, DINNER PLATE, FROZEN PIZZA, FROZEN VEGETABLE, SNACK, SENSOR COOK.**

Control Lockout

The oven operation can be locked to prevent the microwave from accidentally being turned on. All oven functions can be locked.

To Set:

Touch and hold the **CANCEL/OFF** Pad for three seconds. The Display shows "LOCKED" and the oven beeps.

To Cancel:

Touch and hold the **CANCEL/OFF** Pad for three seconds. "LOCKED" disappears from the Display and the oven beeps.

Display

Basic Instructions

1. Touch the **DISPLAY** Pad until the user's language is selected.
2. Touch the **START** Pad.

- ◆ This feature provide you with three languages which are used for showing you menu, instructions, cooking guides and any other terms of microwaving cooking in the display window. You can select one of the languages; English, French, Spanish.

HELP

Basic Instructions

1. Touch the **HELP** Pad.
2. Touch the Pad which has the function you want to know.

- ◆ The **HELP** feature show you the brief function guide for the selected key pad.

Oven Shelf

The glass turntable should **NOT** be removed, when the microwave oven is operated with the oven shelf.

The oven shelf gives you extra space when cooking in more than one container at the same time. (See illustrations below.)

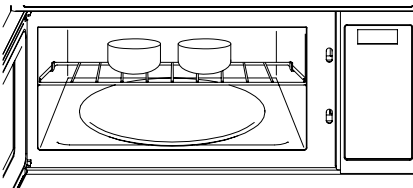
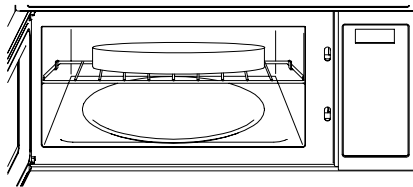

Never operate the oven without foods on the metal shelf to avoid danger of arching or fire. Remove always the metal shelf when not using it.

- ◆ Do not cook with the shelf on the microwave floor. This could damage the microwave.
- ◆ Do not use a microwave browning dish on the shelf. The shelf could overheat.
- ◆ Use a pot holders when handling the shelf after cooking. It may be hot.
- ◆ Do not use the shelf when popping popcorn.

Inserting The Oven Shelf

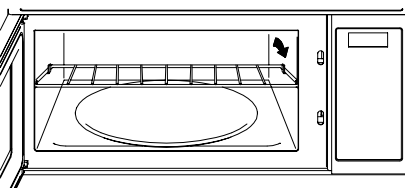

Special Features

Using the Vent Fan

You can control the 2-speed fan by touching the VENT FAN Pad.

Basic Instructions

1. Touch the VENT FAN Pad once for HIGH speed.
The Display will scroll "HIGH VENT FAN".
2. Touch the VENT FAN Pad twice for LOW speed.
The Display will scroll "LOW VENT FAN".
3. Touch the VENT FAN Pad three times for turning vent fan off.
The Display will scroll "OFF VENT FAN".

To Set Fan to Run for a Specific Time:

1. Start fan by touching the VENT FAN Pad.
2. Program run time.
 - ◆ Touch the **TIMER Pad** and hold for 3 seconds. **Display** will show "FAN".
3. Enter desired time.
4. Touch the **START Pad**.

To Cancel Timer:

- ◆ Touch **CANCEL/OFF Pad** twice.

Note . . .

- ◆ If the temperature gets too hot around the microwave oven, the exhaust fan in the vent hood will automatically turn on the **Low** setting to protect the oven. It may stay on up to an hour to cool the oven. When this occurs, the **Fan Off Pad** will not turn the fan off.
- ◆ If both the fan and light are operating and the **TIMER Pad** is touched and held, both the fan and light will be controlled by the timer. The **Display** will alternate between "FAN" and "LIGHT" one time.
- ◆ Canceling the timer will cause the timer to shut off; however, canceling the timer will not cancel the fan. The fan will continue to operate until turned off.

Using the Cooktop Light

You can control the cooktop light by touching the LIGHT Pad.

Basic Instructions

1. Touch the LIGHT Pad once for turning the cooktop light on.
The Display will scroll "ON LIGHT".
2. Touch the LIGHT Pad twice for turning the night light on.
The Display will scroll "NIGHT LIGHT".
3. Touch the LIGHT Pad three times for turning the cooktop light or night light off. The Display will scroll "OFF LIGHT".

To Set Light to be on for a Specific Time:

1. Turn on light by touching the **LIGHT Pad**.
2. Program "ON" time.
 - ◆ Touch the **TIMER Pad** and hold for 3 seconds. **Display** will show "LIGHT".
3. Enter desired time.
4. Touch the **START Pad**.

To Cancel Timer:

- ◆ Touch **CANCEL/OFF Pad** twice.

Note . . .

- ◆ If both the fan and light are operating and the **TIMER Pad** is touched and held, both the fan and light will be controlled by the timer. The **Display** will alternate between "FAN" and "LIGHT" one time.
- ◆ Canceling the timer will cause the timer to shut off; however, canceling the timer will not cancel the light. The light will continue to operate until turned off.

Care and Cleaning

Microwave Oven Interior

The oven interior should be cleaned after each use with a damp cloth to keep it free from grease and soil buildup. Stubborn soils can be removed with a plastic scrub pad. When cleaning interior surfaces and surfaces of door and oven that come together when the door is closed, use only mild, non-abrasive soaps or detergents applied with a sponge or soft cloth. Odors can be eliminated from the inside of the oven by boiling a solution of one cup of water and several tablespoons of lemon juice in the oven for 5-7 minutes. This also helps loosen any dried soil in the oven. Wipe off excess moisture after use.

Note . . .

- ◆ **Do not** spray or pour liquid cleansers directly onto a surface. Spray or pour cleanser onto a cloth or sponge and then clean.
- ◆ **Do not** use abrasive cleaners, oven cleaners, abrasive cleaning pads or steel wool, as they can scratch or dull oven surfaces.
- ◆ **Do not** remove or insert knife around the stirrer cover to clean, it may damage the cover or affect the cooking performance of your oven.

Oven Bottom

Wash oven bottom with hot sudsy water, rinse and dry. Do not use excessive amounts of water when cleaning the oven, especially around the turntable. Do not allow water or cleaning agents to seep into turntable gears located underneath.

Glass Tray/Turntable

Allow to cool before removing and cleaning. Wash in soapy water or dishwasher.

Roller Guide

Clean frequently to prevent excessive noise. Wash in soapy water or dishwasher.

Oven Exterior

Wipe the outside of your oven with a soapy cloth, rinse and dry. Do not use abrasive cleaners. They may scratch the surface.

Light Compartment

Clean off the grease and dust on the light compartment cover on the bottom side of the microwave oven often with warm water and detergent.

Control Panel

Wipe with a damp cloth. Dry. Do not spray cleaners directly on panel. Spray cleaners on cloth and then wipe.

Care and Cleaning

The Exhaust Feature

The exhaust hood feature on your microwave oven is equipped with two metal filters which collect grease. When the fan is operating, air is drawn up through the filters and is then discharged through the venting to the outside or through the charcoal filters if not vented to the outside.

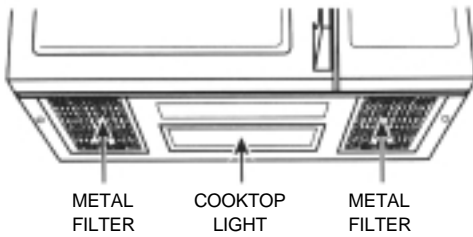

Reusable Grease Filters

The reusable grease filters should be cleaned at least once a month. Never operate the microwave without the filters in place. In situations where flaming might occur on surfaces below the hood, filters will stop the entry of flames into the unit.

To Remove Grease Filter

To remove grease filter, grasp the "finger hold" on the filter and slide to the rear. Then pull filter downward and to the front. The filter will drop out.

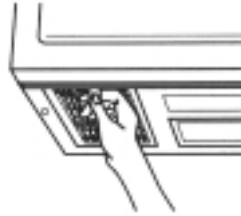

To clean Grease Filter

To clean grease filters, soak and then agitate filter in solution of hot water and detergent. Do not use ammonia or ammonia products because they will darken the metal. Light brushing can be used to remove embedded dirt. Rinse, shake and remove moisture before replacing.

To Replace Grease Filter

To replace grease filter, slide the filter in the frame slot on the back of the opening. Pull filter upward and to the front to lock into place.

Light Bulb Replacement

Cooktop Light

To replace the combination cooktop light/night light:

1. Disconnect power at main fuse or circuit breaker or pull plug.
2. Remove screw on left side of light compartment cover and lower cover until it stops. (See Figures 1 and 2.)
3. Gently unscrew the bulb(s). Be sure bulb(s) to be replaced are cool before removing.
4. Replace with 30-watt incandescent bulb(s) available from your authorized dealer. High intensity 30-watt bulb(s) which are available in supermarkets and hardware stores, may also be used for replacements.
5. Raise light compartment cover and replace screw.
6. Connect electrical power to microwave oven.

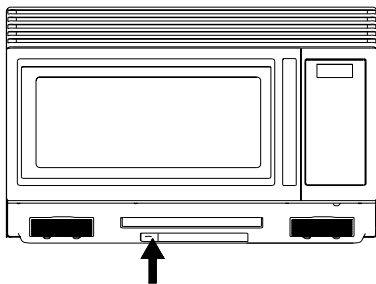

FIGURE 1

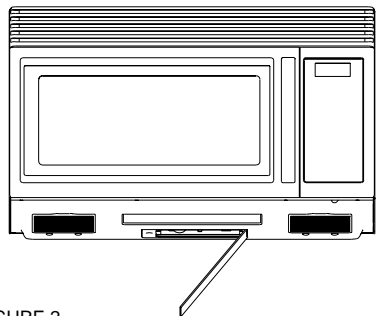

FIGURE 2

Oven Light

To replace oven light:

1. Disconnect power at main fuse or circuit breaker or pull plug.
2. Remove the top grill by taking out the 2 screws that hold it in place. (See Figures 3.)
3. Remove charcoal filter.
4. Pull out the Lamp cover. (See Figure 4.)
5. Replace the light bulb with a 30-watt bulb.
6. Replace light housing to original position
7. Replace charcoal filter.
8. Replace top grill and secure with screws.
9. Connect electrical power.

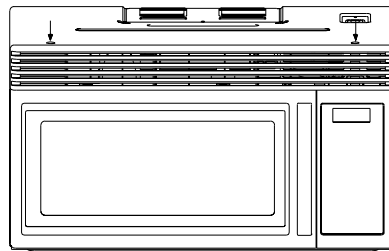

FIGURE 3

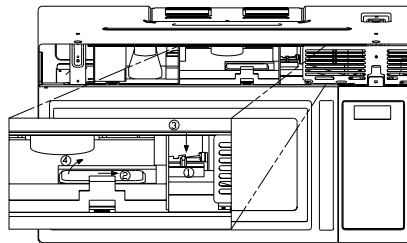

FIGURE 4

Common Questions and Answers

Q & A

Q. Can I open the door when the oven is operating?

A. The door can be opened anytime during the cooking operation. The oven will automatically stop cooking and the time setting will maintain until the door is closed and the **START Pad** is touched.

Q. What causes the oven interior light and display to dim when using a Variable Power Level?

A. This is normal and indicates the oven is operating and cycling properly.

Q. Why does steam and/or vapor escape around the door and moisture droplets form on the inside of the oven door?

A. This is normal occurrence - as food cooks, steam is given off.

Q. What do the various beeps mean?

A. Short beep = any pad is touched.

Three short beeps = incorrect entry.

One long beep = oven plugged in.

Three long beeps = end of cooking (microwave will turn off).

Series of three short beeps = check food to see if turning or rearranging is needed.

Q. Can the oven be used with the glass tray or roller guide removed?

A. No. Both the glass tray and roller guide must always be used in the oven when cooking.

All these things are normal with your microwave oven.

- ◆ Steam or vapor escaping from around the door.
- ◆ Light reflection around the door or outer case.
- ◆ Dimming oven light and change in blower sound may occur while operating at power levels other than high.
- ◆ Dull thumping sound while oven is operating.

Charcoal Filter Kit

There is a recirculating charcoal filter kit included for models that are not vented to the outside. See installation guide for details.

Before You Call

Check the following to be sure a service call is necessary:

If noting on the oven operates:

- ◆ check for a blown circuit fuse or a tripped main circuit breaker.
- ◆ check if oven is properly connected to electric circuit in house.
- ◆ check that controls are set properly.
- ◆ check that the cooking time is set.

If the oven interior light does not work:

- ◆ The light bulb may be loose or defective. See page 20 or call a qualified servicer.

If oven will not cook:

- ◆ check that control panel was programmed correctly.
- ◆ check that door is firmly closed.
- ◆ check that **START Pad** was touched.
- ◆ **Auto Start** may have been set.
- ◆ the **Control Lockout** may have been set
- ◆ check the area between the door and seal for obstructions.

If oven takes longer than normal to cook or cooks too rapidly:

- ◆ be sure the **Power Level** is programmed properly.
- ◆ check instructions on food density, etc.
- ◆ verify that voltage to the microwave oven is not low.

If the time-of-day clock does not always keep correct time:

- ◆ check that the power cord is fully inserted into the outlet receptacle.
- ◆ check that the oven is properly grounded.
- ◆ try plugging the oven into an outlet on a separate electrical circuit.

If oven floor or glass tray are hot:

- ◆ this is normal. The floor is absorbing heat from the food.

If the interior of oven collects moisture:

- ◆ this is normal. Food gives off moisture when cooking and the steam collects on the door and the oven surface. Wipe off excess moisture from oven after each use.

If food cooks unevenly:

- ◆ refer to your recipe for proper cooking procedures.
- ◆ be sure food is evenly shaped.
- ◆ be sure food is completely defrosted before cooking.
- ◆ check placement of aluminum strips used to prevent overcooking.

If food is undercooked:

- ◆ check recipe to be sure all directions (amount, time, and power levels) were correctly followed.
- ◆ check household voltage.
- ◆ try plugging the oven into an outlet on a separate electrical circuit.
- ◆ be sure food was completely defrosted before cooking.

If food is overcooked:

- ◆ check recipe to be sure all directions (amount, time, and power levels) were correctly followed.
- ◆ the initial temperature of food may have been higher than normal.

If arcing (sparks) occur:

- ◆ be sure microwave-safe dishes were used.
- ◆ be sure wire twist ties were not used.
- ◆ be sure oven was not operated when empty.

If the display shows a time counting down but the oven is not cooking:

- ◆ check that door is firmly closed.

Microwave Oven Warranty

DAEWOO ELECTRONICS COPORATION OF AMERICA warrants each new microwave oven manufactured by it to be free from defective material and workmanship and agrees to remedy any such defect or to furnish a new part (at the Company's option) in exchange for any part of any unit of its manufacture which under normal installation, use, and service. To establish and receive warranty service from us or authorized service facilities, proof of purchase/dated sales invoice is required.

Return authorization must be obtained before any merchandise is returned to the factory.

This warranty does not extend to any of our microwave ovens which have been subjected to misuse, neglect, accident, incorrect wiring not our own, improper installation, unauthorized modification, or to use in violation of instructions furnished by us, nor units which have been repaired or altered outside of our factory, nor to cases where the serial number thereof has been removed, defaced, or changed.

This warranty is in lieu of all warranties expressed or implied and no representative or person is authorized to assume for us any other liability in connection with the sale of our microwave ovens.

Model	Parts	Labor	Magnetron
KOT-170SW / 170SB / 172S	1 year	1 year	8 years

For Service or Assistance, please call 1-800-553-4355 or visit website www.magicchef-ewave.com

Free Manuals Download Website

<http://myh66.com>

<http://usermanuals.us>

<http://www.somanuals.com>

<http://www.4manuals.cc>

<http://www.manual-lib.com>

<http://www.404manual.com>

<http://www.luxmanual.com>

<http://aubethermostatmanual.com>

Golf course search by state

<http://golfingnear.com>

Email search by domain

<http://emailbydomain.com>

Auto manuals search

<http://auto.somanuals.com>

TV manuals search

<http://tv.somanuals.com>