

Video Cassette Recorder



User's Guide

DV-T87N

As an **ENERGY STAR**[®] Partner, DAEWOO has determined that this product meets the **ENERGY STAR**[®] guidelines for energy efficiency.

DAEWOO

Safety information

	CAUTION RISK OF ELECTRIC SHOCK DO NOT OPEN	
CAUTION: TO REDUCE THE RISK OF ELECTRIC SHOCK, DO NOT REMOVE COVER (OR BACK). NO USER-SERVICEABLE PARTS INSIDE. REFER SERVICING TO QUALIFIED SERVICE PERSONNEL.		

 The lightning flash with arrowhead symbol, within an equilateral triangle, is intended to alert the user to the presence of uninsulated "dangerous voltage" within the product's enclosure that may be of sufficient magnitude to constitute a risk of electric shock.

 The exclamation point within an equilateral triangle is intended to alert the user to the presence of important operating and servicing instructions in the literature accompanying the appliance.

WARNING : TO REDUCE THE RISK OF FIRE OR ELECTRIC SHOCK, DO NOT EXPOSE THIS APPLIANCE TO RAIN OR MOISTURE.
CAUTION : TO PREVENT ELECTRIC SHOCK, MATCH WIDE BLADE OF PLUG TO WIDE SLOT, FULLY INSERT.

IMPORTANT SAFEGUARDS

In addition to the careful attention devoted to quality standards in the manufacture of your video product, safety is a major factor in the design of every instrument. However, safety is your responsibility too. This sheet lists important information that will help to assure your enjoyment and proper use of the video product and accessory equipment. Please read them carefully before operating and using your video product.

Installation

- 1** Read and Follow Instructions- All the safety and operating instructions should be read before the video product is operated. Follow all operating instructions.
- 2** Retain Instructions- The safety and operating instructions should be retained for future reference.
- 3** Heed Warnings-Comply with all warnings on the video product and in the operating instructions.
- 4** Polarization- This video product is equipped with a polarized alternating -current line plug (a plug having one blade wider than the other). This plug will fit into the power outlet only one way.

This is a safety feature. If you are unable to insert the plug fully into the outlet, try reversing the plug. If the plug still fails to fit, contact your electrician to replace your obsolete outlet. To prevent electric shock, do not use this polarized plug with an extension cord, receptacle, or other outlet unless the blades can be fully inserted without blade exposure. If you need an extension cord, use a polarized cord.

- 5** Power Sources-This video product should be operated only from the type of power source indicated on the marking label. If you are not sure of the type of power supply to your home, consult your video dealer or local power company. For video products intended to operate from battery power, or other sources, refer to the operating instructions.
- 6** Overloading- Do not overload wall outlets of extension cords as this can result in a risk of fire or electric shock. Overloaded AC outlets, extension cords, frayed power cords, damaged or cracked wire insulation, and broken plugs are dangerous. They may result in a shock or fire hazard. Periodically examine the cord, and if its appearance indicates damage or deteriorated insulation,

i. Daewoo Video Cassette Recorder User's Guide

Safety information, *continued*

have it replaced by your service technician

- 7** Power-Cord Protection- Power-supply cords should be routed so that they are not likely to be walked on or pinched by items placed upon or against them, paying particular attention to cords at plugs, convenience receptacles, and the point where they exit from the video product.
- 8** Ventilation- Slots and openings in the case are provided for ventilation to ensure reliable operation of the video product and to protect it from overheating. These openings must not be blocked or covered. The openings should never be blocked by placing the video product on a bed, sofa, rug, or other similar surface. This video product should never be placed near or over a radiator or heat register. This video product should not be placed in a built-in installation such as a bookcase or rack unless proper ventilation is provided or the video product manufacturer's instruction's have been followed.
- 9** Attachments- Do not use attachments unless recommended by the video product manufacturer as they may cause hazards.
- 10** Water and Moisture- Do not use this video product near water- for example, near a bath tub, wash bowl, kitchen sink or laundry tub, in a wet basement, or near a swimming pool and the like. Caution : Maintain electrical safety. Powerline operated equipment or accessories connected to this unit should bear the UL listing mark or CSA certification mark on the accessory itself and should not be modified so as to defeat the safety features. This will help avoid any potential hazard from electrical shock or fire. If in doubt, contact qualified service personnel.
- 11** Accessories- Do not place this video product on an unstable cart, stand, tripod, bracket, or table. The video product may fall, causing serious injury to a child or adult as well as serious damage to the video product. Use this video product only with a cart, stand, tripod, bracket, or table recommended by the manufacturer or sold with the video product. Any mounting of the product should follow the manufacturer's instructions and use a mounting accessory recommended by the manufacturer.
- 11A** A video product and cart combination should be moved with care. Quick stops, excessive force, and uneven surfaces may cause the video product and cart combination to overturn.



Note to CATV system installer

This reminder is provided to call the CATV system installer's attention to Section 820-40 of the NEC which provides guidelines for proper grounding and, in particular, specifies that the cable ground shall be connected to the grounding system of the building, as close to the point of cable entry as practical.

- 12** Outdoor Antenna Grounding- If an outside antenna or cable system is connected to the video product, be sure the antenna or cable system is grounded so as to provide some protection against voltage surges and built-up static charges. Section 810 of the National Electrical Code, ANSI/NFPA No. 70-1984 (Section 54 of Canadian Electrical Code, Part 1) provides information with respect to proper grounding of the mast and supporting structure, grounding of the lead-in wire to an antenna-discharge unit, connection to grounding electrodes, and requirements for the grounding electrode. See example as shown.

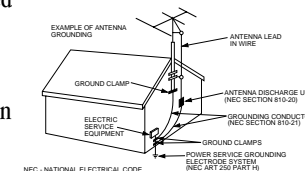

ii. Daewoo Video Cassette Recorder User's Guide

- 13** Power Lines- An outside antenna system should not be located in the vicinity of overhead power lines, other electric light or power circuits, or where it can fall into such power lines or circuits. When installing an outside antenna system, extreme care should be taken to keep from touching or approaching such power lines or circuits as contact with them might be fatal. Installing an outdoor antenna can be hazardous and should be left to a professional antenna installer.

Use

- 14** Cleaning- Unplug this video product from the wall outlet before cleaning. Do not use liquid cleaners or aerosol cleaners. Use a damp cloth for cleaning.
- 15** Object and Liquid Entry- Never push objects of any kind into this video product through openings as they may touch dangerous voltage points or "short-out" parts that could result in a fire or electric shock. Never spill liquid of any kind on the video product.
- 16** Lightning- For added protection for this video product during a lightning storm, or when it is left unattended and unused for long periods of time, unplug it from the wall outlet and disconnect the antenna or cable system. This will prevent damage to the video product due to lightning and power line surges.

Service

- 17** Servicing- Do not attempt to service this video product yourself as opening or removing covers may expose you to dangerous voltage or other hazards. Refer all servicing to qualified service personnel.
- 18** Conditions Requiring Service- Unplug this video product from the wall outlet and refer servicing to qualified service personnel under the following conditions.
- When the power-supply cord or plug is damaged.
 - If liquid has been spilled, or objects have fallen into the video product.
 - If the video product has been exposed to rain or water.
 - If the video product does not operate normally by following the operating instructions. Adjust only those controls that are covered by the operating instructions. Improper adjustment of other controls may result in damage and will often require extensive work by a qualified technician to restore the video product to its normal operation.
 - If the video product has been dropped or the cabinet has been damaged.
 - When the video product exhibits a distinct change in performance- this indicates a need for service.
- 19** Replacement Parts- When replacement parts are required, have the service technician verify that the replacements he uses have the same safety characteristics as the original parts. Use of replacements specified by the video product manufacturer can prevent fire, electric shock, or other hazards.
- 20** Safety Check- Upon completion of any service or repairs to this video product, ask the service technician to perform safety checks recommended by the manufacturer to determine that the video product is in safe operating condition.
- 21** Wall or Ceiling Mounting- The product should be mounted to a wall or ceiling only as recommended by the manufacturer.
- 22** Heat- The product should be situated away from heat sources such as radiators, heat registers, stoves, or other products (including amplifiers) that produce heat.

Overview of the equipment	1
Front panel	1
Front panel display	2
Back panel	3
Remote control	4
Connecting your VCR	8
Connecting an antenna to the VCR	8
Connecting your VCR to your TV	9
Connecting a cable system	11
Setting up your VCR	13
Turning the VCR on	13
Changing the on-screen menu language	13
Setting the clock	14
Selecting cable or antenna viewing	15
Programming the channel memory	15
Setting the Cable Box (Cable Box Setup)	18
Selecting output channel (CH3 or CH4)	19
Using video cassettes	20
Protecting video cassettes from accidental erasure	20
Inserting / Removing video cassettes	20
Watching recorded programs	21
Playing a video cassette	21
Searching forward while viewing a video cassette	21
Searching backward while viewing a video cassette	21
Pausing a video cassette during playback	21
Stopping video cassette playback	21
Fast forwarding the video cassette	21
Rewinding the video cassette	22
Slow motion / Adjusting the picture	22
Recording programs	23
Preparing to record a program (manual or timer) / Manual recording	23
Timer recording	24
Reviewing timer programs / Cancelling timer programs	26
One touch timer recording (OTR)	27
Using advanced features	28
Recording stereo or secondary audio programs (SAP)	28
Selecting an audio playback option	28
Play the tape automatically	29
Switch the VCR to TV or VCR mode automatically	29
Searching a cassette tape for programs (indexing)	30
Searching with the tape counter (go-to search)	30
Marking a tape for zero search / Child Lock	31
CM Skip / Display (O.S.D) / Daylight-Saving Time	32
Duplicating video cassette tapes with another VCR	33
Connecting a Audio system to this VCR	34
Glossary	35
Troubleshooting	36
Specifications	38
Warranty	39

Overview of the equipment

This section summarizes the buttons, controls, and terminals that you will use with your VCR.

Front panel

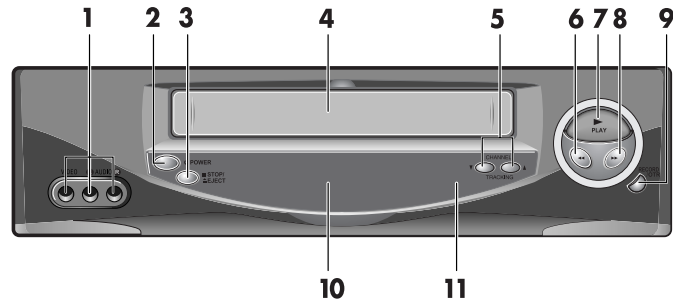

- 1 FRONT AUDIO/VIDEO JACK**
Attach the VCR's audio & video input at these terminals.
- 2 POWER**
Press to turn the VCR on or off.
- 3 STOP/EJECT**
Press to stop tape movement and to eject a video cassette.
- 4 Cassette compartment**
Insert a video cassette into this slot.
- 5 CHANNEL/TRACKING ▼/▲**
Press to change the channel (channels stored in memory only) or to adjust the tracking.
- 6 REW**
Press to rewind a video cassette.
- 7 PLAY**
Press to play a video cassette or press to during video cassette playback to temporarily stop playback
- 8 FF**
Press to fast forward a video cassette.

✓
• To use the Front AV jack, check the 'Video2' is displayed on the TV screen by pressing the INPUT key, after connecting the Front AV jack to Camcorder or another VCR.

9 RECORD/OTR

Press to record the program currently airing on the channel. Press multiple times to process one-touch-recording (OTR) time options.

10 Display panel

Displays information to assist you in operating the VCR successfully.

11 Remote Sensor

This receiver receives a signal from your remote control. Do not block it.

Front panel display

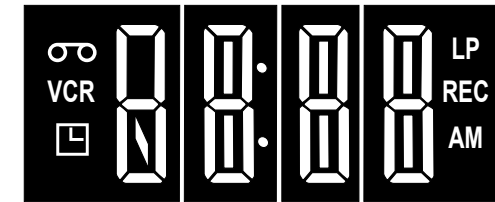

On/OFF	Turned on/off	SLOW	Slow Motion
PLAY	Playback	REC	Record
FF	Fast Forward	PAUS	Pause
SCH	Forward Search	STOP	Stop
REW	Rewind	SP/EP	Tape Speed
SCH-	Reverse Search	EJCT	Eject
HIFI	Hi-Fi	REC	TimerRecording
□ RO:30,R1:00 OTR (One Touch Recording)			

* When the lighted indicator is blinking on the display panel, the VCR is in the child lock mode.

Back panel

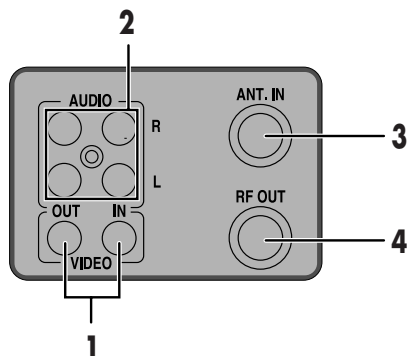

- 1 VIDEO IN/OUT**
Attach the VCR's video input/output at these terminals.
- 2 AUDIO IN/OUT**
Attach the VCR's audio input/output at these terminals.
- 3 Antenna terminal**
Attach an antenna or cable system at this terminal.
- 4 RF OUT**
Use this terminal to connect to a VHF/UHF antenna or to your television RF input.

Remote control

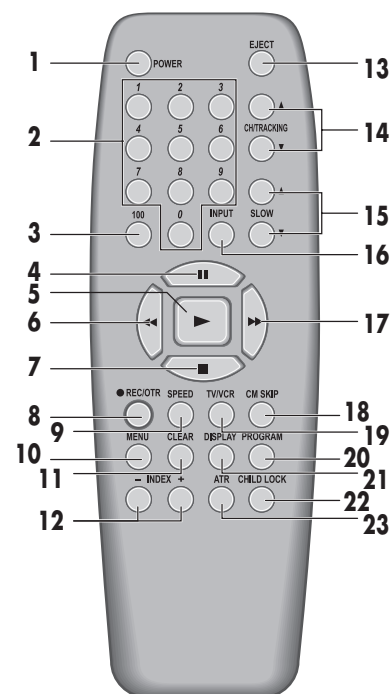

- 1 POWER**
Press to turn your VCR on or off.
- 2 0-9**
Press to select channels or to make certain selections when using the menu system.
- 3 100**
Press in combination with the **0-9** buttons to select channels greater than 100.
- 4 P/S II**
Press to pause video tape playback for temporarily still picture. Each press of the button advances the picture one frame.
- 5 PLAY ►**
Press to play a video cassette.
- 6 REW ◀◀**
Press to rewind a video cassette.
- 7 STOP ■**
Press to stop tape movement.
- 8 REC/OTR ●**
Press to record the program currently airing on the channel. Press multiple times to process one-touch-recording (OTR) time options.
- 9 SPEED**
Press to select tape recording speed (SP, or EP)
- 10 MENU**
Press to display the main menu.
- 11 CLEAR**
Press to delete previous selections.
- 12 INDEX + / - (Up / Down)**
In stop mode, Press to displays Index Search.

- ✓ Objects between the remote control and VCR will block the path of the remote control beam.
- Dark walls, direct sunshine or very bright light will reduce the remote sensor's sensitivity.
- The remote control will not work correctly if you press several buttons at the same time.

13 EJECT

Press to eject a video cassette from the compartment.

14 CH/TRACKING ▲/▼ (Up / Down)

Press to change the channel (channels stored in memory only) or to adjust the tracking.

15 SLOW ▲/▼ (Up / Down)

Press to allow slow-motion playback.

16 INPUT

Press to select between the VCR tuner and the Audio/Video Input jacks. (auxiliary).

17 FF ►►

Press to fast forward a video cassette.

18 CM SKIP

Press during playback mode to skip commercials or program segments.

19 TV/VCR

Press to select the TV or VCR tuner.

20 PROGRAM

Press to go directly "TIMER RECORDINGS" in MENU.

21 DISPLAY

Press to display the tape counter, clock and status mode on the TV screen.

22 CHILD LOCK

Press to disable VCR usage or to protect set timer recordings, the unit can be locked so that the buttons on the VCR or remote control don't work.

23 ATR

Press to remove any streaks from the picture automatically.

Installing the remote control batteries

- 1 Open the battery compartment on the back of the remote control.

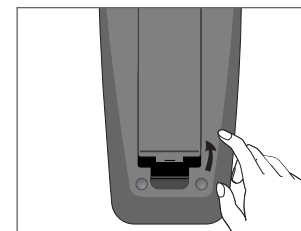

- Do not mix different types of batteries, or mix an old and a new battery.
- Remove and replace weak batteries. Weak batteries can leak and damage your controller. Dispose of batteries properly; never throw them into a fire.

- 2 Install two AAA size batteries as shown. Make sure the "+" and "-" terminals are oriented correctly.

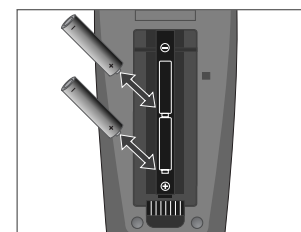

- 3 Replace the cover.

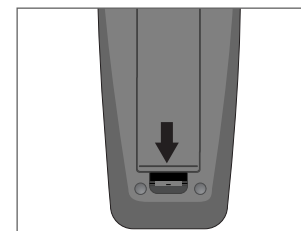

Using the remote control

Hold the remote control within an angle range of about 30° from either side of the remote sensor. The remote control range is about 23 feet (7m) from the VCR.

Point the front of the remote control directly at the front of the VCR.

Overview of the equipment, *continued*

Accessories

Carefully remove the VCR from the carton. Check that the VCR has not been damaged. The following accessories are included.

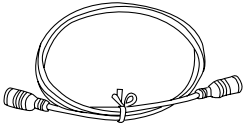
1 Wireless Remote Control NOTE : Required 2 'AAA' batteries.	2 Coaxial cable for connecting the VCR to your TV's VHF terminal.
	

To get a replacement remote, please call 1-800-DAEWOO8 (1-800-323-9668) to get a replacement remote and talk to parts department.

Connecting your VCR

You must connect your VCR to an external antenna or cable system. Next you will connect the VCR to the television. Follow the directions below to make these connections. You will normally only make one of the connections shown below, not all of them.

Connecting an antenna to the VCR

- **If your antenna ends in a single coaxial lead,** press or screw the cable onto the ANT. IN terminal on the back of your VCR.

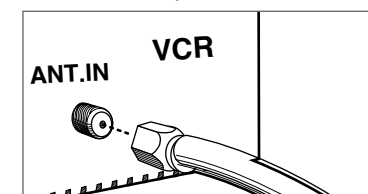

- **If your antenna ends in a pair of 300 ohm twin leads,** use a 300-ohm/75-ohm adapter (Not Supplied). Place the leads underneath the screws on the adapter, tighten the screws, then press the adapter onto the VCR ANT. IN terminal.

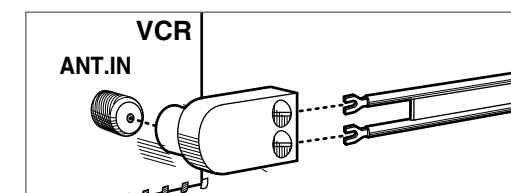

Antennas with two sets of leads

You may have two sets of leads from your antenna system.

- **If your antenna system has both a coaxial lead and twin 300-ohm leads,** purchase a combiner (available at electronics stores). Press or screw the coaxial lead onto the combiner; place the twin leads underneath the screws on the combiner and tighten the screws. Press the cable from the combiner onto the ANT. IN terminal on the back of your VCR.

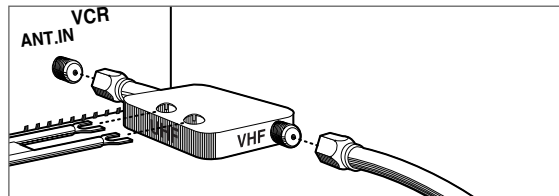

- **If your antenna system has two sets of twin 300-ohm leads**, purchase a combiner (available at electronics stores). Place one set of twin leads underneath the screws on the combiner and tighten the screws. Do the same with the other set of twin leads. Press the cable from the combiner onto the ANT. IN terminal on the back of your VCR.

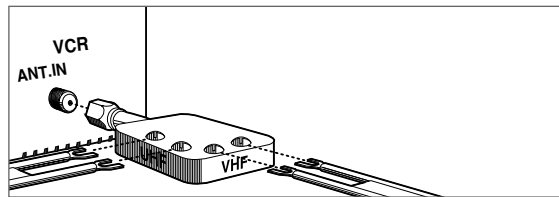

Connecting your VCR to your TV

- 1 Connect one end of a coaxial cable to the RF OUT terminal on the back of the VCR.

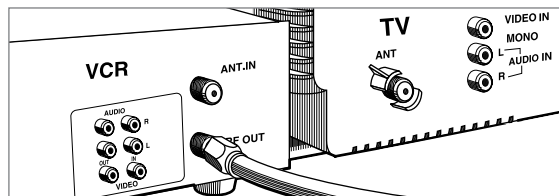

- 2 Connect the other end of the coaxial cable to the ANT. IN terminal on the back of the TV.

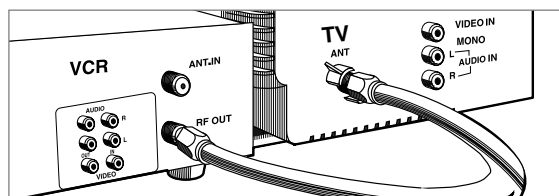

- If you have a coaxial terminal for VHF signals and twin lead terminals for UHF signals, you need an adapter (Not supplied) as shown below:

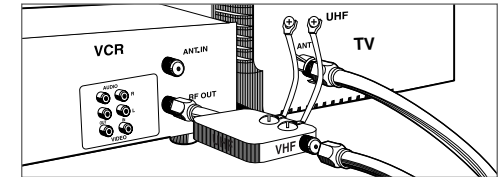

- If you have twin lead terminals for all signals, you need an adapter (Not supplied) like this:

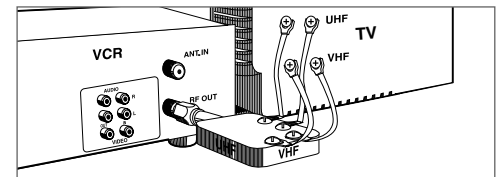

If your TV does not have Audio/Video inputs, you have finished connecting your VCR to your TV. If your TV does have Audio/Video inputs, you may want to follow the section below.

Connecting to a TV with Audio/Video inputs

- 1 Connect a video cable to the VIDEO OUT terminal on the back of the VCR.
- 2 Connect the other end of the video cable to the VIDEO IN terminal on the TV.

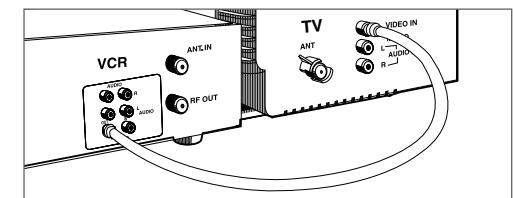

- 3 Connect a pair of audio cables to the AUDIO OUT terminal on the back of the VCR. If you have a mono (non-stereo) TV, connect only the white (left) terminal.

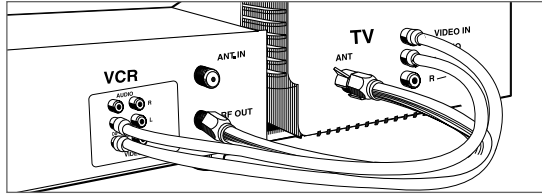

- 4 Connect the other end of the audio cables to the AUDIO IN terminals on the TV. If you have a mono (non-stereo) TV, connect only the white (left) terminal.

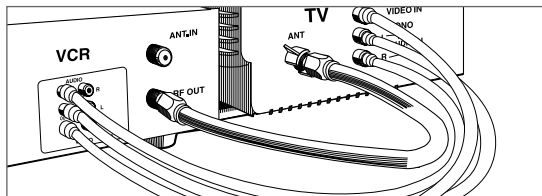

Connecting a cable system

If your cable set-up is not described below, please contact your cable company for more information.

- **If your cable system does not require the use of a cable box**, simply press or screw the incoming cable onto the ANT IN terminal on the back of your VCR.

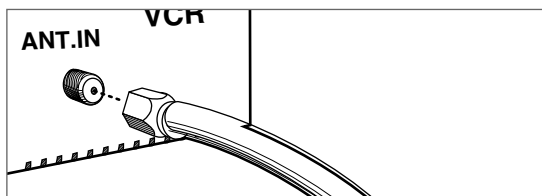

- **If your cable system requires you to use a converter box for all channels**, connect the incoming cable to the IN terminal on the converter box. Connect another cable between the OUT terminal on the converter box and the ANT. IN terminal on the VCR. Keep your VCR tuned to channel 3 or 4 and change channels using the converter box.

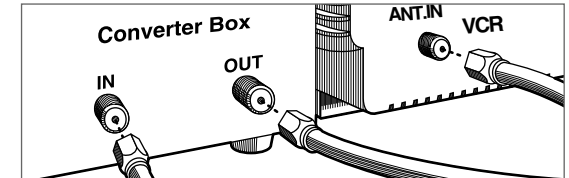

- **If your cable system only requires you to use a converter box for some channels** (i.e., pay-TV channels), follow these steps: Find the primary incoming coaxial cable. Plug this cable into a splitter (available at your local electronics store.) Connect one coaxial cable between one OUT terminal on the splitter and the IN terminal on the converter box.

Connect another coaxial cable between the other OUT terminal on the splitter and the A-IN terminal on an A/B switch (available at your local electronics store.) Connect a third coaxial cable between the OUT terminal on the converter box and the B-IN terminal on the A/B switch.

Connect a coaxial cable between the OUT terminal on the A/B switch and the ANT. IN on your VCR.

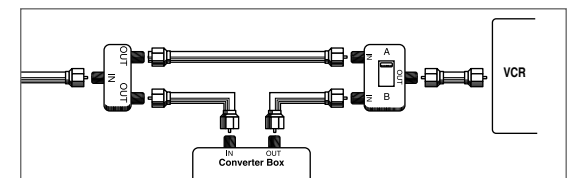

When the A/B switch is in the B position, use the converter box to change channels ; when the A/B switch is in the A position, use the VCR to change channels.

Setting up your VCR

Once you have connected your VCR and put batteries in the remote control, you are ready to use the VCR. Before you start, however, you must be certain to do the following:

- Turn on the television.
- Tune the television to channel 3 or 4 (whichever channel you selected when connecting the VCR).

Turning the VCR on

- 1 Press POWER on the remote control. You can also press POWER on the VCR's front panel.
- 2 Set the VCR to VCR mode by pressing TV/VCR on the remote control if the VCR indicator "VCR" is not lit.

Changing the on-screen menu language

You may select the language in which you would like the VCR's menu to be displayed: English, Spanish, or French.

- 1 Press MENU to display the main menu.

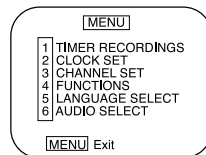

- 2 Press 5 to select Language.

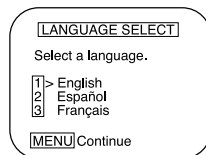

- 3 Press 1 to select English, 2 to select Español or 3 to select Français.
- 4 Press MENU once to return the main menu, which will be displayed in the language you selected. Press MENU again to exit the menu system and return to normal viewing.

Setting the clock

The clock displays the current time and is used for timer recording. Therefore, it is important to set the time and date accurately.

If you are setting the clock for the first time, or if a power failure has erased the clock settings, the clock will display --:--.

- 1 Press MENU to display the menu.
- 2 Press 2 to select Clock Set

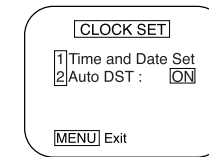

- 3 Press 1 to select Time and Date Set.

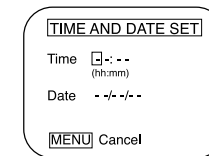

- 4 Use 0-9 to enter the hour and the minutes.

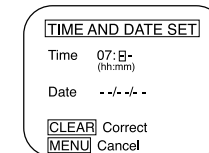

- 5 Press 1 if it is AM; press 2 if it is PM.

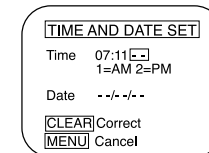

- 6 Use 0-9 to enter the month, day, and year. The VCR will automatically add the correct day of the week according to the date that is selected.

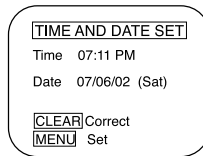

- 7 Press Menu to save the settings and exit from the Time and Date Set menu.
- 8 Press MENU again to exit the menu system and return to normal viewing.

Selecting cable or antenna viewing

You must set the viewing mode for your VCR, choosing either CABLE (cable system connection) or ANTENNA (antenna connection). To set the viewing mode:

- 1 Press MENU to display the menu.
- 2 Press 3 to select Channel Set.

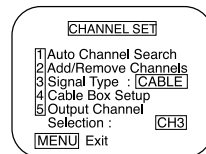

- 3 Press 3 to toggle the setting between CABLE and ANTENNA. When the desired viewing mode is displayed, press MENU twice to exit.

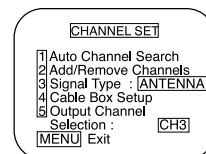

Programming the channel memory

The VCR's channel memory determines the channels that are visible when you press CH/TRACKING ▲/▼. You can add or remove channels from memory.

Setting channels automatically (Auto Channel Search)

Make sure that you use the auto channel search feature during daytime broadcast hours. If you use the auto channel search feature at late night, you may eliminate channels that air only daytime programming.

- 1 Press MENU display the main menu.
- 2 Press 3 to select Channel Set.

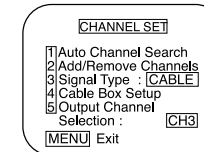

- 3 Press 1 to select Auto Channel Search mode and press 3 to detect the channel automatically and the scanning channel number appears. Wait until the channel numbers stop changing (one to two minutes), and one of the memorized channel appears.

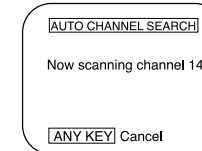

- 4 Press CH/TRACKING ▲/▼ to view the memorized channels.

Removing channels manually

To erase a channel manually,

- 1 Press MENU to display the menu.
- 2 Press 3 to select Channel Set.

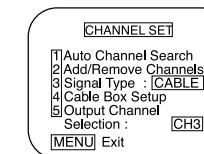

• Detect Automatically

;A strong cable or antenna signal in your area may cause Auto Detect to mis-detect. If this should happen, select 1 or 2 for the system you have.

- 3** Press 2 to select Add/Remove Channels.



- 4** Use 0-9 to enter the channel you want to remove.

- 5** Press CLEAR to erase the channel.



- 6** When you are finished removing channels, press MENU three times to exit from the menus.

Adding channels to memory

If you have removed a channel from memory, you can easily add it back again. To add channels:

- 1** Use 0-9 to tune to the channel you would like to add.
- 2** Press MENU to display the main menu.
- 3** Press 3 to select Channel Set.

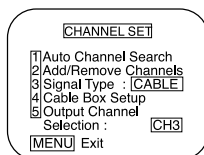

- 4** Press 2 to select Add/Remove Channels.

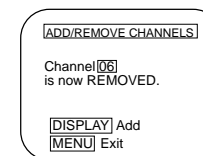

- 5** Press DISPLAY to add the channel.

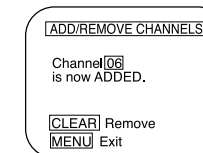

- 6** Press MENU three times to exit from the menus.

Setting the Cable Box (Cable Box Setup)

- 1** Press MENU to display the menu.
- 2** Press 3 to select Channel Set.
- 3** Press 4 to process Cable Box setup

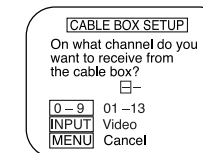

- 4** Press the channel number (01~13) or input key which matches to the output of the Cable Box to connect between Cable Box and VCR.

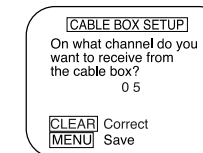

- 5** Press CLEAR on the remote to correct setup status.
- 6** Press MENU when you are finished.
- 7** Press MENU to exit the menu system.

✓ When you make a timer recording, the preset channel number will be displayed automatically.

Selecting output channel (CH3 or CH4)

you must set output channel for your VCR choosing either CH3 or CH4. To set the out channel :

- 1 Press MENU to display the menu.
- 2 Press 3 to select Channel Set.

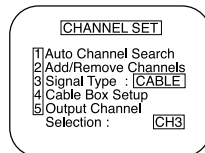

- 3 Press 5 to toggle the setting between CH3 and CH4. When the desired output channel is displayed, Press MENU twice to exit

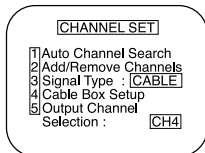

- * The default output channel is setup CH3

Using video cassettes

✓ *Audio-visual material may include works of copyright which must not be recorded without authorization of the copyright owner.*

✓ *If you insert a video cassette without a safety tab into the VCR:*

- After setting the timer recording program, "□" will blink on the display panel in the power off mode and the VCR will automatically eject the cassette.
- In the power on mode, the VCR will playback automatically

✓ *If you insert a video cassette with a safety tab intact into the VCR:*

- After setting the timer recording program, the VCR will be stand-by mode in power off mode.
- !
- Do not attempt to pull out the video cassette once the VCR begins to load the video cassette.
- Do not insert fingers or any foreign object beyond the door flaps of the cassette compartment; this could lead to injury or equipment damage.
- Do not attempt to insert a video cassette if the VCR is unplugged.

Before you play or record on a video cassette tape, be certain to read this information on the proper care and use of video cassettes.

Only use video cassettes that bear the VHS mark: **VHS**.

There are four types of video cassettes: T-60, T-90, T-120, and T-160. The amount you can record on a tape is dependent upon the tape speed at which you record. The table below lists the recording time (hours:minutes) for each tape type according to recording speed.

Tape Type	SP Mode (Standard Play)	EP Mode (Extended Play)
T-60	1:00	3:00
T-90	1:30	4:30
T-120	2:00	6:00
T-160	2:40	8:00

Protecting video cassettes from accidental erasure

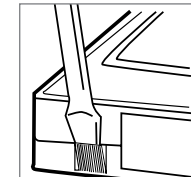

Cassettes have a safety tab to prevent erasure. Break off the safety tab with a screw driver. If you wish to record on a cassette without a safety tab, cover the hole with cellophane tape.

Inserting video cassettes

Firmly insert the cassette into the cassette compartment with the label up. An inverted cassette cannot be inserted.

Removing video cassettes

Press STOP/EJECT on the VCR front panel and the VCR will eject the tape. Pull the cassette out gently.

Watching recorded programs

To watch a program recorded on a video cassette tape:

- Turn on the television.
- Set the TV to channel 3 or 4 or to the video input.
- Insert a video cassette.

Playing a video cassette

If the video cassette has no safety tab (e.g., a rented video cassette), the VCR will automatically play the tape once you insert it. If the VCR does not play the video cassette, press **PLAY**.

Searching forward while viewing a video cassette

To search forward on a video cassette, press **FF**. The video cassette will advance rapidly and display a picture, but no sound. If you repress the **FF**, the video cassette will advance more rapidly. Press **PLAY** to return to normal play.

Searching backward while viewing a video cassette

To search backward on a video cassette, press **REW**. The video cassette will rewind rapidly and display a picture, but no sound. If you repress the **REW**, the video cassette will rewind more rapidly. Press **PLAY** to return to normal play.

Pausing a video cassette during playback

To temporarily stop playback, press **P/S**. The picture will freeze and the sound will stop. Press **PLAY** to return to normal play.

Stopping video cassette playback

To stop a video cassette, press **STOP**.

Fast forwarding the video cassette

To quickly advance the video cassette:

- 1** Press **STOP** if the VCR is currently playing.
- 2** Press **FF**. The video cassette will advance at high speed without picture and sound.

Watching recorded programs, *continued*

Rewinding the video cassette

To rewind the video cassette:

- 1** Press **STOP** if the VCR is currently playing.
- 2** Press **REW**. The video cassette will rewind at high speed without picture and sound.

Slow motion

You can view a tape during Play-Pause using slow motion.

- 1** Press **P/S** to freeze the picture.
- 2** Press **FF/REW** to speed up or down slow motion playback.

The VCR switches automatically from slow motion playback to stop after a few minutes.

Adjusting the picture

The Digital Auto Tracking System automatically adjusts the tracking to obtain the best possible picture. To manually adjust the tracking during playback, press **CH/TRACKING ▲/▼**.

Recording programs

You have three options for recording TV programs: Manual, Timer, and One touch recording.

Preparing to record a program (manual or timer)

Before you begin recording:

- Turn on the television.
- Set the TV to channel 3 or 4 or to the video input.
- Insert a video cassette (with a safety tab) into the VCR.
- If the VCR indicator "VCR" is not lit, press **TV/VCR**.
- If your VCR is connected to:
 - an antenna, set the viewing mode to "ANTENNA."
 - a cable system, set the viewing mode to "CABLE."

Manual recording

Watching and recording the same channel

To watch and record the same channel:

- 1 Be certain to do the steps in the section, "Preparing to record a program," above .
 - 2 Use 0-9 or CH/TRACKING ▲/▼ to select the channel number.
 - 3 Press SPEED to select the recording speed.
 - 4 Press REC/OTR to begin recording. The REC indicator lights.
- Press STOP to stop the recording.

Watching one channel and recording another

- 1 Perform steps 1-4 in "Watching and recording the same channel," above.
- 2 Press TV/VCR to switch to TV mode.
- 3 Use the television's remote control to select the television channel you want to watch. The VCR will continue to record the program.

✓ See "Selecting cable or antenna viewing." p. 15, for information on setting the viewing mode.

✓ Press P/S if you would like to momentarily stop the recording. Press REC/OTR to resume recording. If you do not press REC within five minutes of pressing P/S, the VCR will automatically release the pause and stop the recording to prevent damage to the tape.

✓ Since the VCR has its own TV tuner, it is not necessary to turn on the TV in order to make a recording. Turning on the TV merely allows confirmation of proper channel settings on your VCR.

Recording programs, continued

Timer recording

There are four timer modes: One time, Daily, Weekdays, and Weekly

- 1 Be certain to do the steps in the section, "Preparing to record a program," as shown on previous page.
- 2 Make certain the clock is set to the correct time.
- 3 Press MENU to display the menu.
- 4 Press 1 to select Timer Recordings.

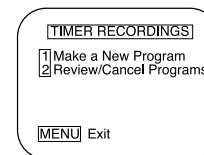

- 5 Press 1 to select Make a New Program.

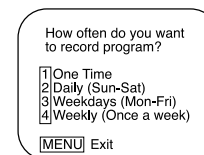

- 6 Press 1 for One Time; 2 for Daily; 3 for Weekdays, or 4 for Weekly.

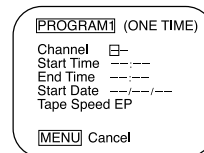

- 7 Use 0-9 to enter the channel number to record. While the VCR is in the CABLE mode, if a channel over 100 is desired, press 100's key and then the next 2 digits in order.

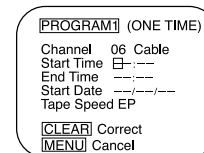

✓ Timer recording allows you to record up to eight different programs within one year period. Once you have set the timer for timer recording, the VCR will turn on, record the program you selected, and then shut off automatically.

✓ If the VCR is in cable box setup mode, the preset channel number will be displayed automatically.

✓ See page 20 for information, about tape speed. Understanding tape speed options will ensure that you are able to completely record a program without running out of tape and that you are able to record programs with the level of picture quality you desire.

- 8** Use 0-9 to enter the recording start time.

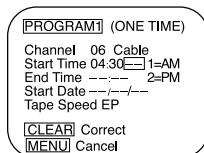

- 9** Use 0-9 to enter the recording end time. AM/PM and the current date/year will be selected automatically.

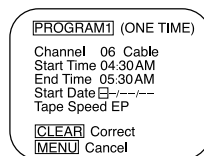

- 10** Use 0-9 to set the date that the program airs. Day(Sat)/Year(01) will be automatically.

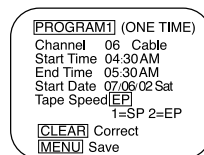

- 11** Press 1 or 2 to select the recording speed and press MENU and the following screen will appear.

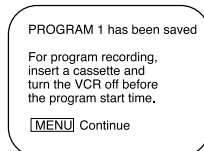

- 12** Press MENU three times repeatedly to return to normal viewing and if you want to make a new program, press MENU and restart from step 4 to 11.

✓ To turn the VCR off after setting up a timer recording program, press POWER on the remote control or POWER on the VCR. The timer recording indicator will light.

- To stop a timer recording program in process, press and hold STOP for about five seconds.
- When the timer recording indicator appears, the VCR is in standby and cannot be operated. To release the VCR from standby, press POWER.

Reviewing timer programs

If you want to review the timer programs that you set up:

- 1 Press MENU to display the menu.
- 2 Press 1 to select Timer Recordings.

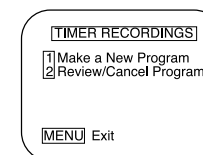

- 3** Press 2 to select Review/Cancel Programs.

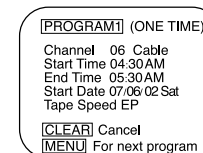

- 4** Press MENU to view additional timer programs.

Cancelling timer programs

To cancel timer recording programs before recording starts :

- 1 Press MENU to display the menu.
- 2 Press 1 to select Timer Recordings.

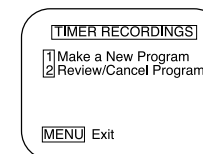

- Press 2 to select Review/Cancel Programs. Press MENU to cycle the programs.

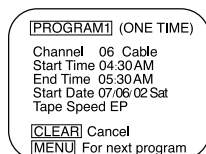

- When the program contents to be erased is displayed, press CLEAR to cancel it.
- Press MENU repeatedly to return to normal viewing.

One touch timer recording (OTR)

One touch timer records a program for a preset recording time (30 minutes to 4 hours).

- Be certain to do the tasks in the section, "Preparing to record a program".
- Use 0-9 or CH/TRACKING ▲/▼ to select the channel to record.
- Press REC/OTR to begin recording.
- Continue to press REC/OTR to increase the time length of the recording.

Press REC/OTR	To record
one time	normal (no recording time limit)
two times	30 mins.
three times	1 hour
four times	1 hour 30 mins.
five times	2 hours
six times	3 hours
seven times	4 hours
eight times	normal (no recording time limit)

- To stop the recording in progress, press and hold STOP approximately 5 seconds.

✓ Be certain when using manual or one-touch recording that your recording does not conflict with timer recordings that you set up.

Using advanced features

✓ The following guidelines will help you decide on the best method for recording programs. Choose:

- Stereo reception for normal recording and to record broadcast stereo television.
- Mono reception if the stereo signal is weak and sound is too "noisy."
- SAP reception to record a second audio program. An example of a SAP is a program that is broadcast in English, but has a Spanish SAP.

✓ You can only record stereo and SAPs if the program is a broadcast in stereo or with a SAP. Consult a television guide for program broadcast information.

✓ The following guidelines will help you to determine the best audio playback mode. Choose:

- "Hi-Fi" to play back sound recorded on the Hi-Fi track.
- "Linear" to play back the sound recorded on the linear mono track.
- "Mix" to play back the sound recorded on both the Hi-Fi track and the linear track.

This section describes the advanced features of your VCR. **Recording stereo or secondary audio programs (SAP)**

Programs are broadcast in mono or stereo audio, or with a SAP. To record in stereo or a SAP:

- Turn on the TV and VCR.
- Set the TV to channel 3 or 4 or to the video input.
- Set the VCR to VCR mode by pressing TV/VCR.
- Press MENU to display the menu.
- Press 6 to choose Audio Select.

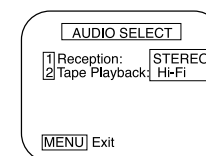

- Press 1 repeatedly to select Stereo, Mono or SAP.

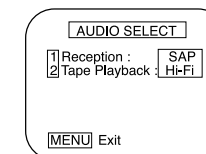

- Record the program in any manner you choose (normal, timer, or one-touch recording).

Selecting an audio playback option

To select Hi-Fi, Linear, or Mix audio playback options:

To set the audio playback:

- Press MENU to display the menu.
- Press 6 to choose Audio Select.

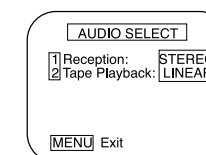

- 3 Press 2 repeatedly to select Hi-Fi, Linear, or Mix.
- 4 Press Menu twice to exit the menu system.

Play the tape automatically

This feature allows the VCR to automatically start playing when you insert a tape with the safety tab removed.

- 1 Press MENU to display the menu.
- 2 Press 4 to choose Functions
- 3 Press 1 to switch between ON and OFF
 - Select ON if you want a tape with its safety tab removed to start playing automatically when the tape is inserted.
 - Select OFF if you do not want a tape with its safety tab removed to start playing automatically.

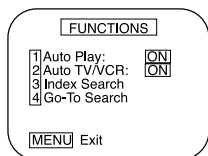

Switch the VCR to TV or VCR mode automatically

This feature controls whether the TV/VCR switch changes automatically to the VCR mode when the VCR is turned on.

- 1 Press MENU to display the menu.
- 2 Press 4 to choose Functions
- 3 Press 2 to switch between ON and OFF
 - Select ON if you want the VCR to switch to the VCR mode when the VCR is turned on or a cassette is inserted. This only applies if you connect the ANT.IN and RF OUT jacks of your VCR and TV and watch your VCR on channel 3 or 4 of your TV.

- Select OFF if you want the VCR to remain in the TV mode. This is useful if you watch your VCR on the TV's video input and you don't want your antenna/cable signal interrupted by the VCR.

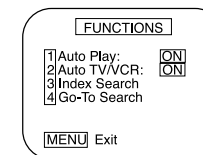

!

If two recordings overlap, the index mark for the second program will be erased. Therefore, when you use the index feature to find the second program, the VCR will skip over it.

If you record multiple programs in one recording session, the VCR will only find the index mark that was placed on the video cassette tape when the recording session began.

! *Some index marks that may be missed by the VCR :*

- A mark too close to your location on the tape.
- The mark at the beginning of a recorded segment of five minutes or less.
- The first index mark on the tape when you start at the beginning of the tape.

Searching a cassette tape for programs (indexing)

When you record a programs, the VCR places an index mark at the start of the recording. To search for an index mark:

- 1 Press MENU to display the menu.
- 2 Press 4 to choose Functions.
- 3 Press 3 to choose Index Search.



- 4 If you want to search through a certain number of index marks, press two number buttons to enter the number of marks you want to search. Press CLEAR on the remote to correct an entry.
- 5 Press REW to search backward or FF to search forward. The VCR will locate your index mark and begin playback. If you did not enter a specific index number, the VCR will locate the next index mark and begin playback. Press STOP to stop index searching.

Searching with the tape counter (go-to search)

You can mark a segment of the video cassette with the tape counter that will help you easily locate the segment later.

- 1 Press MENU to display the menu.

- 2 Press 4 to choose Functions.
- 3 Press 4 to display Go-To Search.

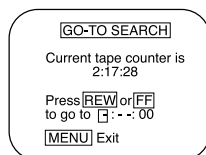

- 4 The tape counter is displayed on the screen. Input the tape counter you want to go and press REW or FF, the VCR will search for the time counter you want.

Marking a tape for zero search

- 1 Use PLAY, REW, or FF to reach the point on the tape that you would like to mark as 0:00:00.
- 2 Press DISPLAY to display the tape counter on the screen.
- 3 Press CLEAR to reset the tape counter to 0:00:00.
- 4 You can continue to play the tape or perform other functions with the VCR.

Child Lock

To disable the usage of the VCR, or to protect your timer recordings, you can lock the VCR so that the buttons on the VCR or remote won't work.

- To lock : Press and hold CHILD LOCK key on the remote for approximately six seconds.
- To release : Press and hold CHILD LOCK key on the remote for approximately six seconds.



Use the tape counter to note the current location of playback on the video cassette.

- To reset the tape counter, press CLEAR and the time counter will be reset to 00:00 anywhere on a tape. See "Searching with the tape counter (go-to search)," p.30/31, for more information on this feature.



SPRING Forward ; Fall Backward

In the Spring, daylight-saving time begins on the first Sunday in April. Because the clock automatically changes from 2:00 AM to 3:00 AM (forward one hour), remember to include the extra hour for timer recording falling within this time frame.

In the Autumn, daylight-saving time ends on the last Sunday in October.

The VCR clock automatically changes from 2:00 AM to 1:00 AM (back one hour). Therefore, it can affect your recording length.

CM Skip

This is useful for skipping commercials or program segments.

- Press CM skip once during playback to advance the tape approximately 30 seconds.
- Each press of the CM skip adds an additional 30 seconds up to 5 minutes.

Display (O.S.D)

Press DISPLAY to display the tape counter, clock and status mode on the TV screen.

And, by one more pressing DISPLAY before disappearing the OSD from the screen, only the tape counter will remain on the screen.

Daylight-Saving Time

- 1 Press MENU to display the menu.
- 2 Press 2 to choose Clock Set.

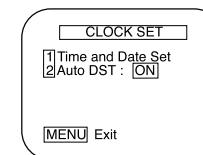

- 3 Press 2 in the Clock Set mode to toggle the setting between AUTO DST ON and OFF.
- Select ON if you want the VCR's clock to automatically adjust for daylight-saving time.
 - Select OFF if you do not want the VCR's clock to adjust for daylight-saving time.

Duplicating video cassettes tape with another VCR

You can duplicate a video cassette tape if you connect a second VCR to this VCR.

Connecting another VCR to this VCR

Make all connections before turning on the power.
Be sure to press INPUT on the recording VCR.

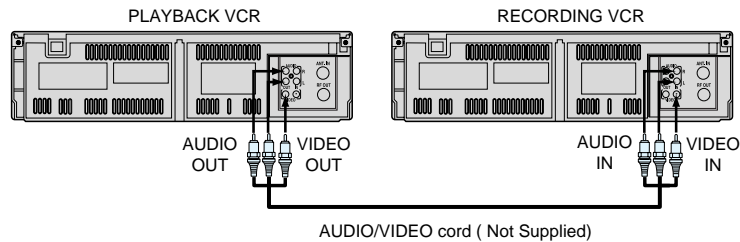

Connecting a Camcorder to this VCR

For duplicating a previously recorded tape from a camcorder, follow the camcorder manufacturer's instructions.

A type of dubbing hookup is shown below. Be sure to press INPUT on the recording VCR.

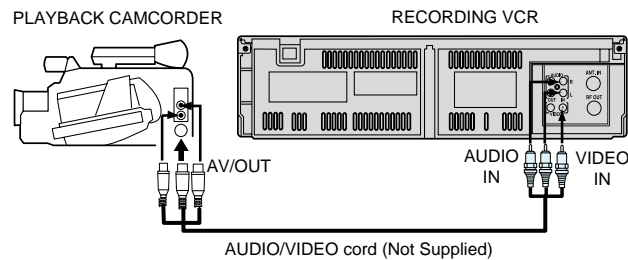

Setting up the VCRs for video cassette duplication

To duplicate a video cassette:

- 1 Load a blank video cassette tape with the safety tab intact into the recording VCR. Press INPUT on the recording VCR.
- 2 Load a previously recorded cassette into the playback VCR or camcorder.
- 3 Press REC/OTR on the recording VCR, then press P/S.
- 4 Press PLAY on the playback VCR or camcorder, then press P/S.
- 5 Press PLAY on the playback VCR and REC/OTR on the recording VCR simultaneously to begin the duplicating process.

!

• It is recommended that the tape speed be set to the SP mode on the recording VCR for best results.

• Unauthorized recording of copyrighted television programs, films, video tapes and other materials may infringe on the rights of copyright owners and be contrary to copyright laws.

Connecting a Audio system to this VCR

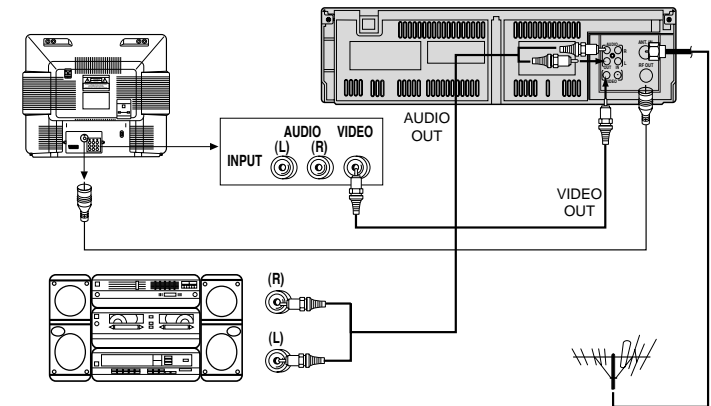

Glossary

AFT: Automatic fine tuning, a circuit that automatically adjusts TV reception to optimum condition.

CABLE: Cable television.

EP: Extended play, the slowest recording speed. Designed to store the maximum amount of program material on a single video cassette. There is some degradation in picture/audio quality.

Index Search: A feature of this VCR that automatically records an index each time recording begins. It helps you locate a particular segment of the tape quickly and easily.

LP: Long Play, an intermediate tape recording speed that combines most of the picture/audio quality obtainable at the standard recording speed with some of the tape economy of Extended Play (EP).

OSD: On-screen display of information pertinent to the features of the VCR.

OTR: One-touch recording, a feature that allows you to record the program you're watching by pressing the REC key. Each press of the key increases the recording time by 30 minutes, up to four hours.

RF: Radio frequency, the composite audio/video signal supplied to a TV receiver (or other video component) by an antenna or cable system.

Safety tab: The plastic tab at the back of a video tape cassette which, when removed, prevents accidental erasure of a recording.

SP: Standard play, the recording speed to use when the best picture quality is of prime importance (and when total recording time is not).

Troubleshooting

Your Daewoo VCR is designed to give you trouble-free performance for many years. If you have a problem with your VCR, try the solutions listed below.

If the suggestions listed below do not solve your problem, contract your Daewoo dealer or an authorized Daewoo service center. You can also call Daewoo directly at 1-800-DAEWOO8(1-800-323-9668).

The front panel display is blank.

Make sure the VCR is plugged in.

The power is on but the VCR does not operate.

Make sure there is a video cassette inserted in the VCR.

A timer recording failed to record on the video cassette.

- Make sure the video cassette's safety tab is in place.
- Verify that you set the timer correctly.
- Make sure there is a video cassette in the VCR.
- Make sure the VCR is plugged in.

Picture quality during playback is poor.

- Adjust the picture quality by pressing CH/TRACKING ▲/▼.
- The head may be dirty. Use a head-cleaning tape.

Picture does not appear when you attempt to play a video cassette.

- Make sure the TV and VCR are set to the same channel (channel 3, 4 or video input).
- Verify the connections between the VCR and the TV.
- Verify that the VCR indicator is lit on the front display.

Remote control doesn't work.

- Make sure the batteries are fresh.
- Make sure that you are using the remote control within the operational range-no more than 30° either

side of the remote sensor centre and no more than 23 feet from the VCR.

- Make sure there is no obstruction between the remote control and the VCR.

Timer clock does not work.

- Make sure the VCR is plugged in and receiving power.
- If the unit has been without power for some period of time, you must reset the clock and all your timer programs.

Video cassette won't go into the cassette compartment.

- Make sure there is not a tape already loaded into the cassette compartment.
- Insert the video cassette with the label side up.

VCR and remote control buttons don't work.

The REW button does not work at the very beginning of a video cassette. The FF, PLAY and REC/OTR buttons do not work at the end of a video cassette.

Emergency indicator 'Err' is blinking.

Check whether it is in child lock mode or not and then press POWER to remove the indicator. If the emergency indicator continues to blink, contact a service technician.

The VCR buzzes when it is on.

The VCR may be in standby mode and the motor is running. This sound is normal.

Video cassette recorder doesn't rewind all the way to the end.

To avoid video cassette tape damage, the VCR stops rewinding near the end of the tape and then slowly finishes rewinding. Do not prematurely eject the tape.

Specifications

System	VHS
Video signal	NTSC color
Channel coverage	VHF Channel 2-13 UHF Channel 14-69 CATV Channels A1-A5, A8, A-W, W+1-W+84
VHF output signal	Channel 3 or 4 (selectable)
Video	
Input: Video line in	Phono-type connector 1.0V (p-p) 75 ohms unbalanced, sync.negative
Output: Video line out	Phono-type connector 1.0V (p-p) 75 ohms unbalanced, sync.negative
Signal to noise ratio	More than 43dB (SP)
Horizontal resolution	220 lines
Audio	
Input: Audio line in	Phono-type connector more than 47K ohms -8.8 dBm, unbalanced
Output: Audio line out	Phono-type connector less than 1.5K ohms -5.8 dBm, unbalanced
Frequency response	Normal: 100Hz-10KHz (SP); Hi-Fi: 20Hz-20KHz
Signal to noise ratio	Normal: more than 42 dB; Hi-Fi: more than 68 dB
Audio distortion	Normal: less than 4% (SP); Hi-Fi: less than 0.7%
Tape transport	
Tape width	12.65 mm (1/2")
Tape speed	SP: 33.35 mm/sec EP: 11.12 mm/sec
Maximum recording time	480 min, with T-160 tape (EP)
Rewind/fast forward time	Approx 130 sec (T-120 tape)
General	
Power requirements	AC120V 60 Hz only
Power consumption	17 W (under 3W in standby mode)
Dimensions	
Set size (W x H x D)	14.17 x 3.58 x 9.37 inches
Carton size (W x H x D)	17.52 x 6.11 x 12.21 inches
Weight (Net)	6.41 lbs
(Gross)	8.37 lbs

Free Manuals Download Website

<http://myh66.com>

<http://usermanuals.us>

<http://www.somanuals.com>

<http://www.4manuals.cc>

<http://www.manual-lib.com>

<http://www.404manual.com>

<http://www.luxmanual.com>

<http://aubethermostatmanual.com>

Golf course search by state

<http://golfingnear.com>

Email search by domain

<http://emailbydomain.com>

Auto manuals search

<http://auto.somanuals.com>

TV manuals search

<http://tv.somanuals.com>