

DAEWOO

VACUUM CLEANER

RC-450

OWNER'S MANUAL

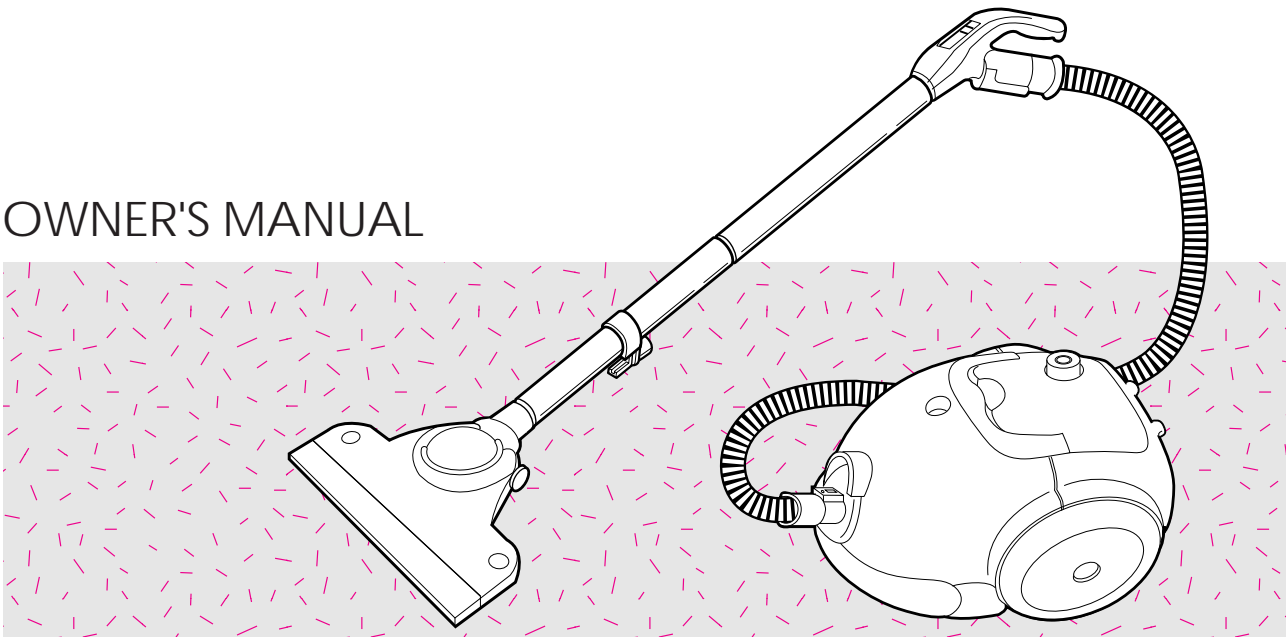

READ AND KEEP THIS

- Thank you for purchasing this vacuum cleaner
- For proper operation, please read this manual before using



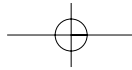

DESCRIPTION AND USING

A DUST METER

- How to check the DUST METER
Operate the cleaner with MAX power and keep the suction brush apart from the floor
- If the red indicator of the DUST METER appears.
 - ⇒ Change the paper filter bag.
 - ⇒ In case the hose is blocked with a large object, remove it.
- When cleaning with the crevice tool or the dusting brush, the red indicator may appear, in this case, continue cleaning.

B HOSE HANDLE

- POWER CONTROL

C CORD REWIND BUTTON

D POWER CORD

- Connect to the same voltage as shown on the rating label.
- To plug or unplug, grasp the plug body. Do not hold or pull the cord.

E CLEANING TOOLS

- Crevice tool
- Dusting tool
- Sweeping/Upholstery Brush

F HOSE ADAPTOR

- When separating the hose from the body, pull the hose adaptor and pressing the button.

G STORAGE

- Loop the hose behind the handle. (See diagram on page 5).

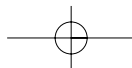

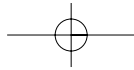

2. DESCRIPTION

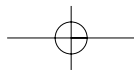
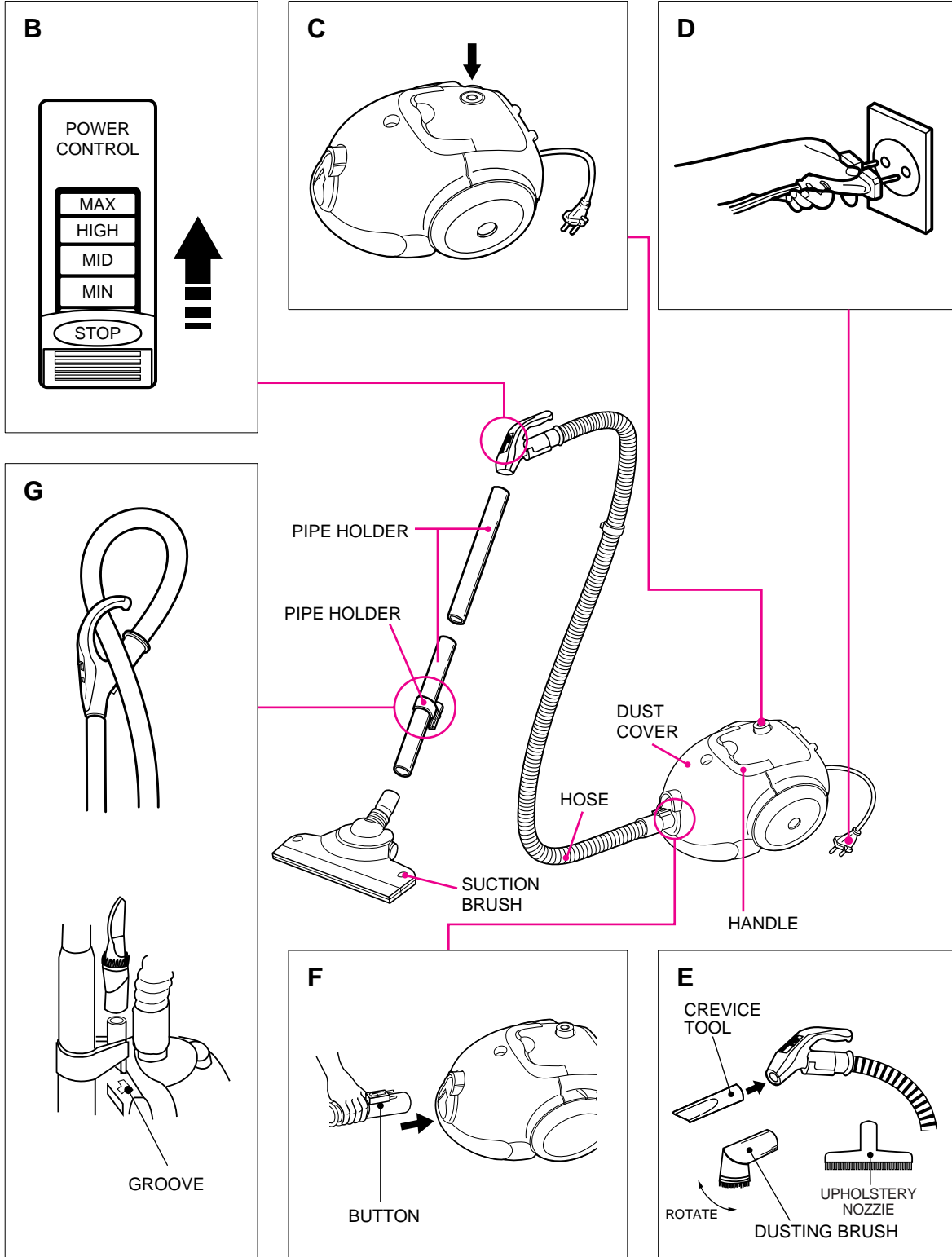

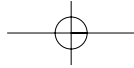

PRECAUTIONS FOR SAFE USE

This vacuum cleaner should only be used for household vacuuming of dry particles only. The manufacturer cannot be held responsible for any damage caused by use or operation of the cleaner contrary to these instructions. If the cleaner is wrongly operated for a purpose other than that for which it is intended, no liability can be accepted for any possible damage.

- Do not vacuum areas which contain moisture or water and inflammable matter, needles, pins, razor blades, matches, cigarette-ends, ect.. since they may damage the cleaner or filter bag or make fire.

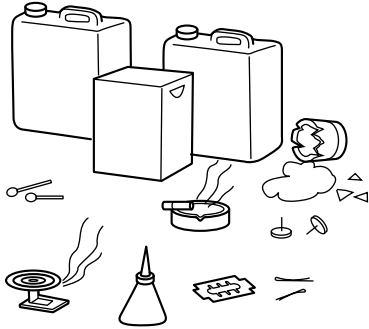

- When rewinding the power cord, hold the plug body before pressing the cord rewind button to prevent whipping.
- Do not pull the power cord out beyond the specified length.

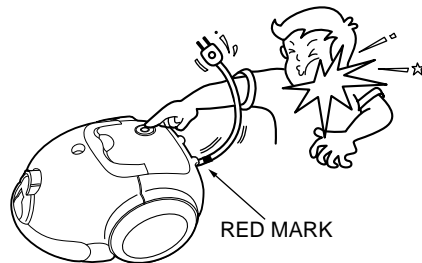

- Make sure a filter bag and a motor protection filter are always inserted.

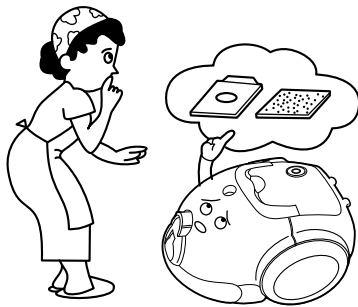

- This product provided with a cable which, if damaged, must be replaced by a repair shop authorized by the manufacturer.

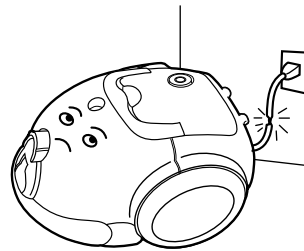

- This hose contains electrical connections.
 - Do not use to suck up water.
 - Do not immerse in water for cleaning.
 - The hose should be checked regularly and must not be used if damaged.

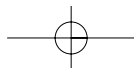
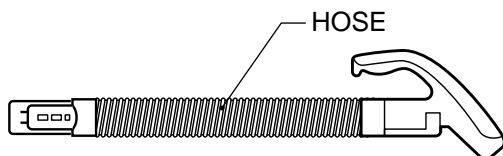

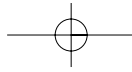

REPLACING THE FILTER BAG

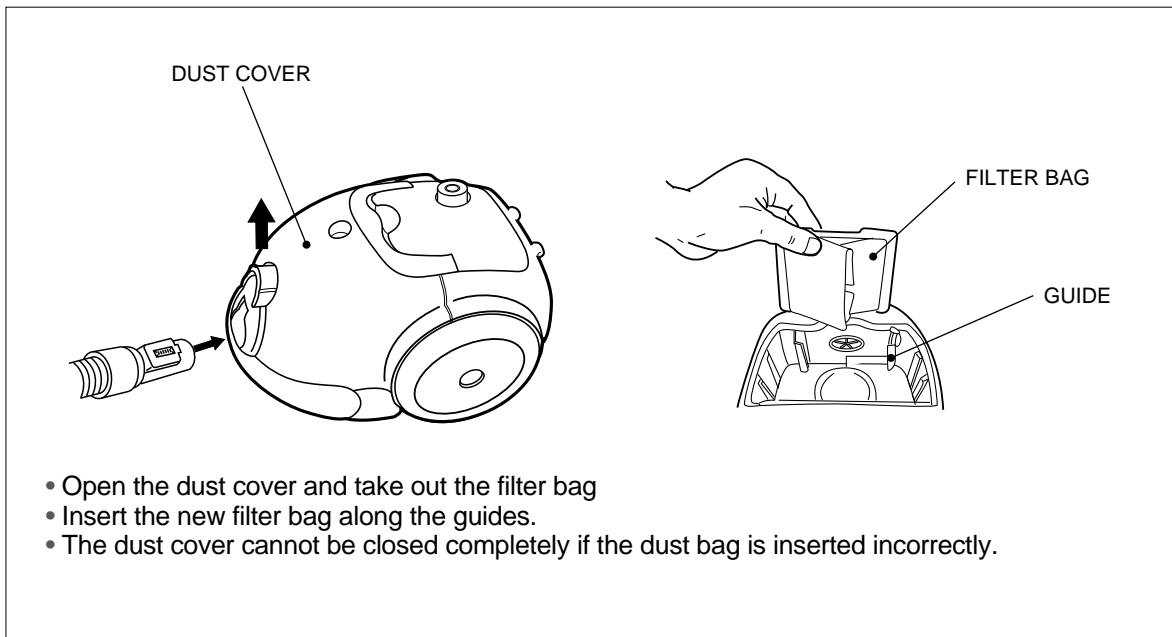

CLEANING THE MOTOR PROTECTION FILTER

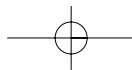
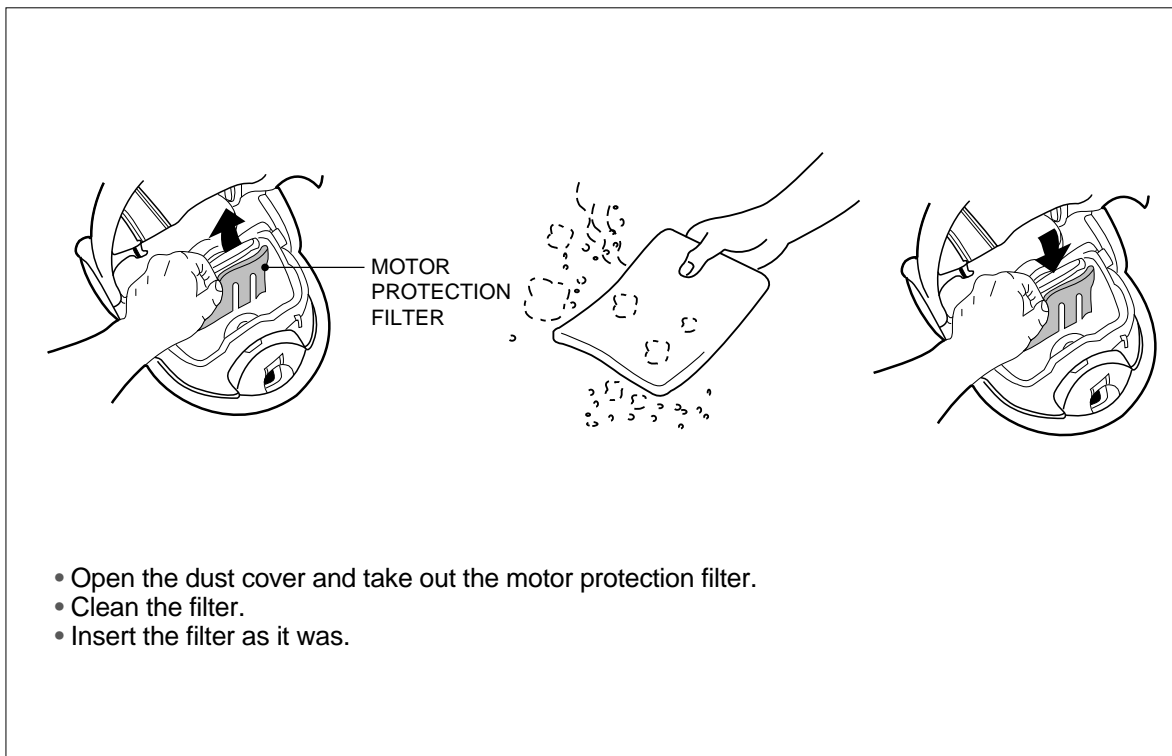

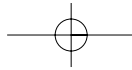

BEFORE ASKING FOR SERVICE

Please check each item below if you have trouble with your cleaner. Before checking, ensure that the cleaner is unplugged from the power supply.

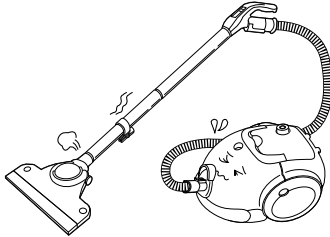
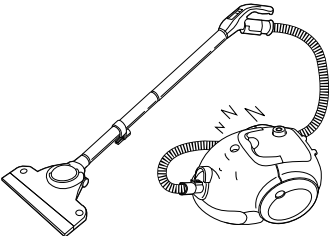
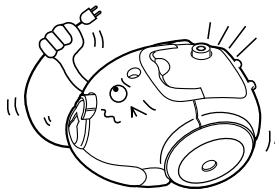
PROBLEM	CHECK POINT	ACTION
<ul style="list-style-type: none"> Suction power is weak 	<ul style="list-style-type: none"> Filter bag Hose 	<ul style="list-style-type: none"> If it is full with dust, change it. If clogged or blocked, remove the object.
<ul style="list-style-type: none"> The cleaner does not work 	<ul style="list-style-type: none"> Could you please check if the hose is inserted correctly into the main body? When the filter bag is full or blocked or any of the accessories are blocked, the over-heating protection for the motor is activated automatically 	<ul style="list-style-type: none"> Insert it completely Switch off and unplug the cleaner and check the dust bag and accessories and remove any blockages. The cleaner can be switched on again after about 30 minutes.
<ul style="list-style-type: none"> Power cord does not rewind.  <ul style="list-style-type: none"> Power cord is not pulled out of the cleaner 	<ul style="list-style-type: none"> Power cord Power cord 	<ul style="list-style-type: none"> Pull the power cord out a little and press the cord rewind button. Do not pull it by force. Rewind it a little by pressing the cord rewind button and pull it out.

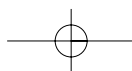

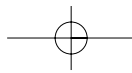

SPECIFICATIONS

Model	RC-450
Rating	220V~240/50Hz
Watts	MAX 1500W
Weights(Body)	5.2kg
Dimension(L x H x D)	376 x 231 x 286mm
Cord Length	6m

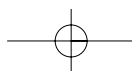

Free Manuals Download Website

<http://myh66.com>

<http://usermanuals.us>

<http://www.somanuals.com>

<http://www.4manuals.cc>

<http://www.manual-lib.com>

<http://www.404manual.com>

<http://www.luxmanual.com>

<http://aubethermostatmanual.com>

Golf course search by state

<http://golfingnear.com>

Email search by domain

<http://emailbydomain.com>

Auto manuals search

<http://auto.somanuals.com>

TV manuals search

<http://tv.somanuals.com>