

Washing Machine Instruction Manual

DWC-LD141X, DWD-LD141X

INSTRUCTION MANUAL

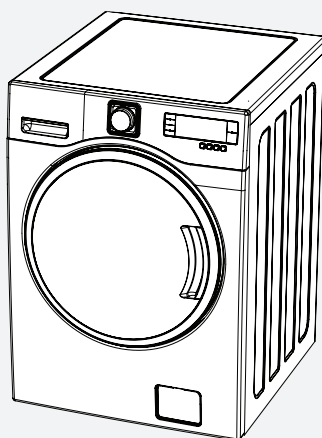

■ Economic wash system

Using artificial intelligence, the washer uses minimum energy and water by selecting optimal water level and washing time.

■ Low noise system

The washer minimizes the washing and spinning noises by sensing the amount of laundry.

■ Child-Lock

The Child-Lock system has been used to prevent children from pressing any button to change the program during operation.

■ Air bubble washing

This is an advanced technology that generates millions of air bubbles inside the drum on washing sequence, and the bubbles dissolve the detergent particles completely and cleanse all the soil in clothes gently and neatly.

■ Self-Cleaning Course of Drum

Enable to Self-Cleaning of Drum.

■ Digital Condensing Dry System.

Condensing Dry System with saveing energy.(for dry model)

Contents

PARTS AND FEATURES	3
WASHER SAFETY	4
INSTALLATION INSTRUCTIONS	5
INLET HOSE CONNECTION	6
ELECTRICAL REQUIREMENTS	7
OPERATING YOUR WASHER	8
THE FUNCTIONS OF THE CONTROL PANEL	10
WASHING PROCEDURE AND PROGRAM SELECTION	12
GUIDE FOR OTHER USEFUL PROGRAMS	22
MAINTENANCE	26
HOW TO CLEAN THE FILTER	27
REMOVING STAINS	28
TROUBLE SHOTING	29
SPECIFICATION	30
WIRING DIAGRAM	31

A NOTE TO YOU

Thank you for buying a DAEWOO appliance.

DAEWOO washers are easy to use, save time, and help you manage your home better.

This manual contains valuable information about how to operate and maintain your washer properly and safely.

Please read it carefully.

Parts and features



The parts and features of your washer are illustrated on the page.
Become familiar with all parts and features before using your washer.

NOTE

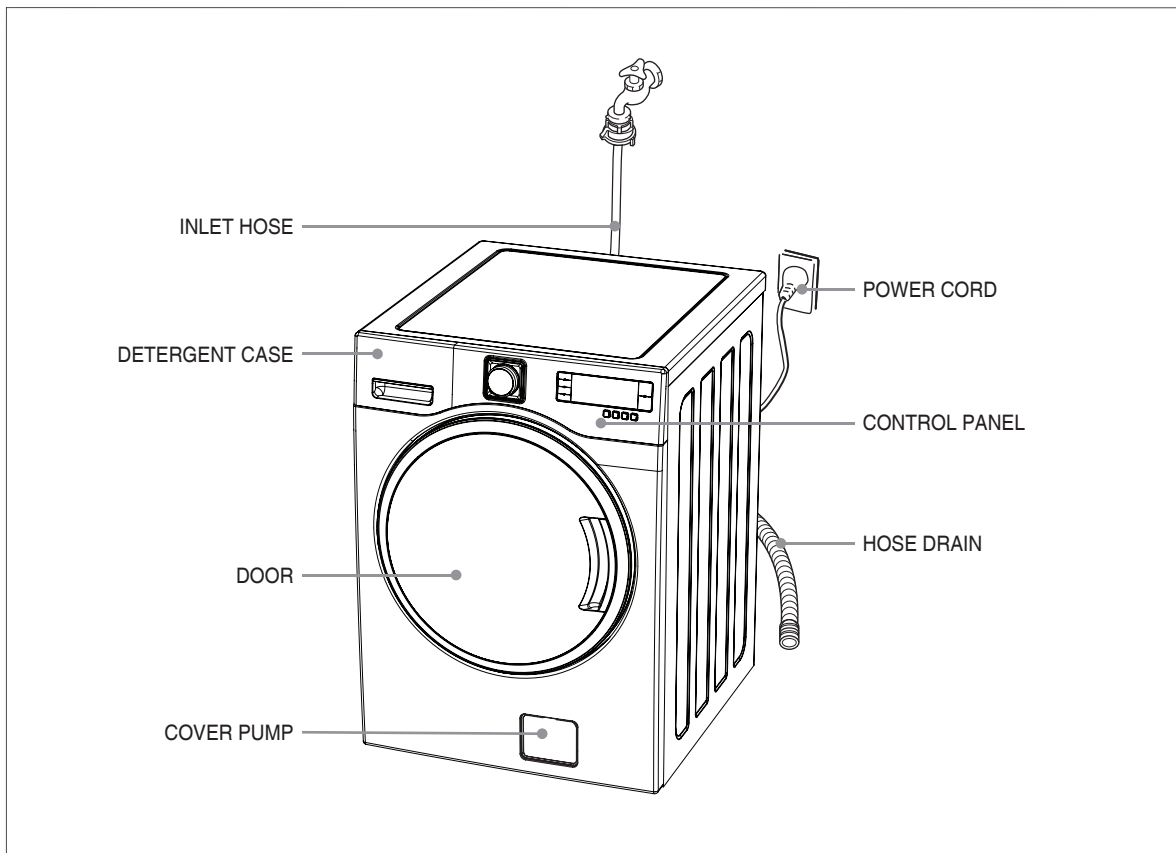
The drawings in the book may vary from your washer model.
They are designed to show the different features of all models covered by this book.
Your model may not include all features.

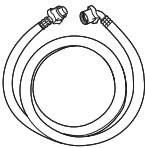

Accessories

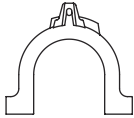
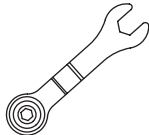
Inlet hose	Manual	Cap holder (4EA)	Guide Hose Drain (Option)	Spanner (Option)
				

Washer safety

Save these instructions

Your safety is important to us.

To reduce the risk of fire, electrical shock, or injury when using your washer adhere to the following basic precautions.

Read all instructions before using your washer

- Flammable fluids (dry-cleaning solvents, kerosene, gasoline, etc.) should not be used or stored in or near your washer. Do not add flammable fluids to your wash water. These substances give off vapors that can create a fire hazard or explosion.
- After starting a cycle, do not reach into the washer until all motions stop.
- Do not tamper with the controls.
- The appliance is not intended for use by young children or infirm persons without supervision.
- If the supply cord is damaged, it must be replaced by the manufacturer, or its service agent or a similarly qualified person in order to avoid a hazard.
- If the appliance is supplied from a cord extension set or electrical portable outlet device it should be positioned so that it is not subjected to splashing or ingress of moisture.

Please ...

- Have only a qualified person install, repair, or replace parts on washer.
- Maintain washer properly.
- Protect washer from the weather and keep it where the temperature will not fall below freezing.
- Do not install the washer at a place of extremely high humidity. It could cause an electric shock or a short circuit.
- Connect washer to the correct outlet, electrical supply, water supply, and drain supply.

Understanding your responsibilities

- Do not use chlorine bleach and ammonia or acid (such as vinegar or rust remover) in the same wash. Hazardous fumes can form.
- Unplug power supply cord before attempting to service your washer.
- Do not wash fiberglass material. Small particles can stick to fabrics washed in following loads and cause skin irritation.
- Do not spray water on the control panel of the washer. It could cause fire or an electric shock.
- In case of the dual valve model, if you connect only one water inlet valve, there can be water leakage from unconnected water inlet valve.
- This appliance must be grounded.
- To avoid electrical shock, use a metal pipe for the ground connection.
- Turn off the water supply valve whenever the washer is not in use.



Caution, risk of fire

Oil-affected items can ignite spontaneously, especially when exposed to heat sources such as in a tumble dryer. The items become warm, causing an oxidation reaction in the oil. Oxidation creates heat. If the heat cannot escape, the items can become hot enough to catch fire. Piling, stacking or storing oil-affected items can prevent heat from escaping and so create a fire hazard.

If it is unavoidable that fabrics that contain vegetable or cooking oil or have been contaminated by hair care products be placed in a tumble dryer they should first be washed in hot water with extra detergent - this will reduce, but not eliminate, the hazard.

Installation instructions

Removing transit bolts

1. Before operating the washer, remove the transit bolts(4ea) along with the rubber.
 - If the bolts are not removed, it may cause heavy vibration, noise and malfunction.

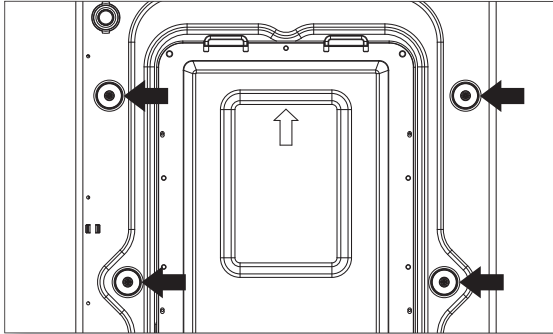

2. Unscrew the 4 bolts with the 10mm hex wrench or spanner or cross-tip screwdriver. Keep the 4 bolts for a later time.
 - When the appliance is transported, transit bolts will be re-used.

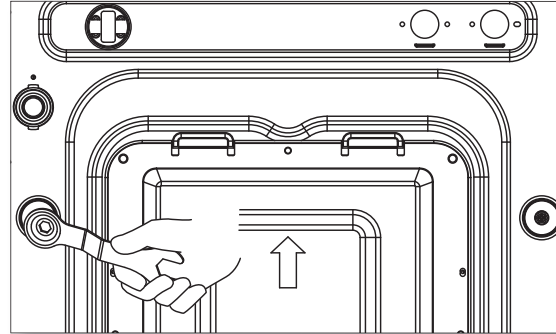

3. Close the holes with the cap holders supplied.

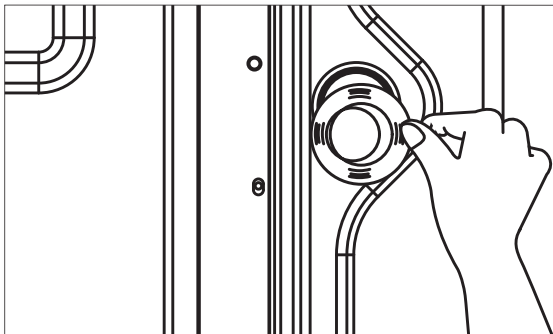

Location of washer

- Check location where the washer will be installed. Make sure you have everything necessary for correct installation.
- Do not place or store your washer below 0°C (32°F) to avoid any damage from freezing.
- Do not place or store laundry products on top of washer at any times
- Install the washer on the horizontal solid floor.
If the washer is installed on an unsuitable floor, it could make considerable noise, vibrate severely and cause a malfunction. If the washer is not level, adjust leg up or down for horizontal installation.
- Ventilation openings must not be obstructed by carpeting when the washer is installed on a carpeted floor.
- Leave some space (right & left : 2cm, rear : 10cm).
- In case of built-in installation, the distance between top of the washer and bottom of upper plate should be at least 3mm.

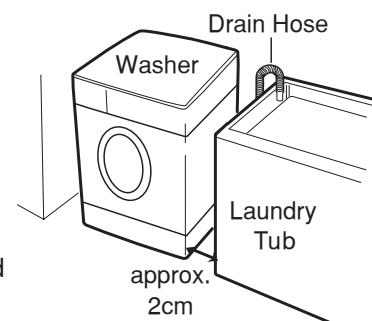

Inlet hose connection

The washer should be connected to the water mains using new hose sets and old hose sets should not be reused.

In using only one water tap or in case of only one water inlet valve, connect the inlet hose to the cold water inlet valve.

Option : Be careful not to confuse hot water inlet and cold water inlet.

For Ordinary Tap

- 1** Pull down the collar of the inlet hose to separate it from the water tap adapter.

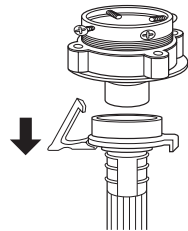

- 2** Loosen the four screws properly in order to fit into water tap.

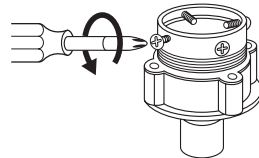

- 3** Fit the water tap adapter into the water tap and tighten the four screws evenly while pushing up the adapter so that the rubber packing can stick to the water tap tightly.

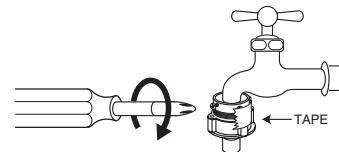

- 4** Remove the tape, and screw connector B into connect A tightly.

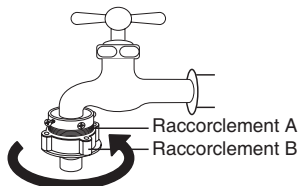

- 5** Connect the inlet hose to the water tap adapter by pulling down the collar of the hose end.

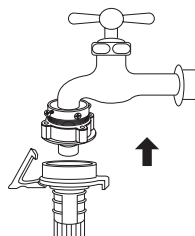

- 6** Connect the inlet hose adapter of the hose to the water inlet of the washer by turning it clockwise to be fixed tightly.

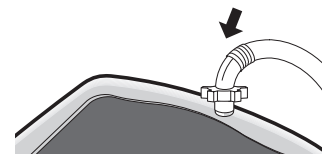

- Please check the rubber packing present inside the inlet hose adapter of the hose.

For Screw-Shaped Tap

- 1** Connect the inlet hose to the water tap by screwing the connector tightly.

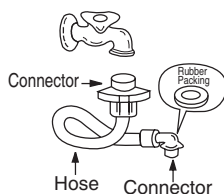

- 2** Connect the connector- inlet supplied if necessary.

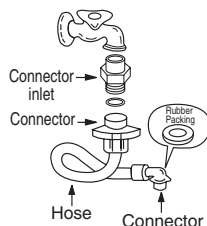

- 3** Connect the inlet hose adapter to the water inlet of a washer and turn it to be fixed.



- *Check the packing in the inlet

Electrical requirements



Electrical shock hazard

Failure to follow these instructions could result in death or serious injury.

- Electrical earth is required on this washer
- If it does not fit the outlet, have a proper outlet installed by a qualified electrician.
- Don't earth to a gas pipe.
- Don't change the power supply cord plug.
- Check with a qualified electrician if you are not sure the washer is properly earthed.

Recommended earthing method

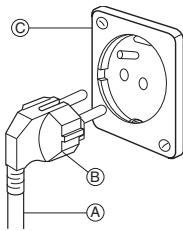

For your personal safety, this washer must be earthed. This washer is equipped with a power supply cord 'A' having an earthing plug 'B'. To minimize possible shock hazard, the cord must be plugged into a mating earthing-type wall receptacle 'C'. If a mating wall receptacle is not available, it is the personal responsibility and obligation of the customer to have the proper earthed wall receptacle installed by a qualified electrician.

Drain system

- Never forget to install drain hose before operating your washer.
- Open the packing box, and there is a drain hose inside the drum.
- Connect the drain hose to the drain outlet at the back side of the washer.
- Top of laundry tub must be at least 60cm high and no higher than 100cm from bottom of washer.

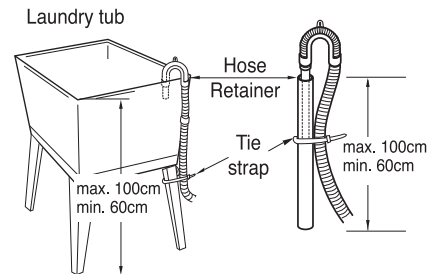
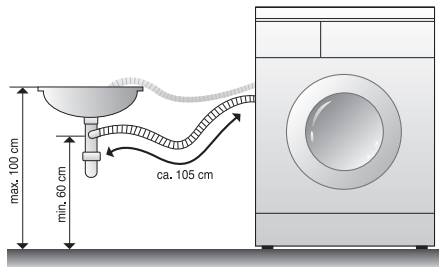

- When installing the drain hose to tub(sink), secure it tightly with a string.
- Proper securing of the drain hose will protect the floor from damage due to water leakage.
- When the drain hose is too long, do not force it back into the washer. This will cause abnormal noise.

Level adjustment

- 1 If the washer is installed on an unsuitable floor, it could make considerable noise, vibrate and cause a malfunction.

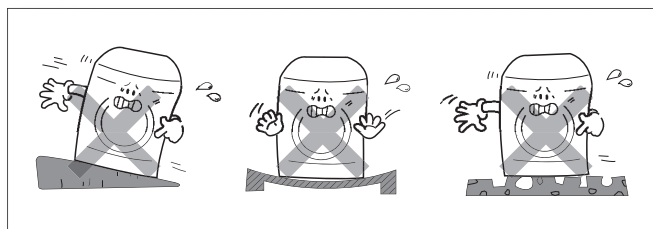

Electrical requirements (cont.)

- 2** Adjust the level of washer using adjustable legs.
- Please check if there is any gap between the four adjustable legs and the floor.
 - Adjust the level of washer by turning adjustable legs. And make it sure that there is no swaying of washer.
 - After the adjustment is finished, turn the fixing nuts up tightly so that the washer maintains the adjustment.

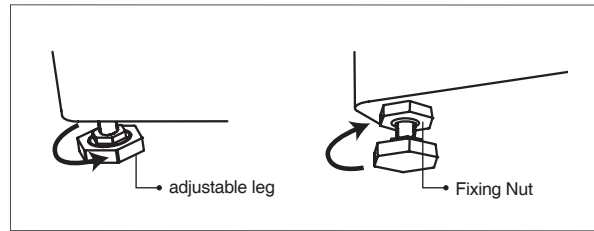

- 3** Make it sure that the washer does not sway when you press down the four corners of the washer's top plate.

NOTE

There should be no swaying of washer and all the adjustable legs should stick to the floor closely.

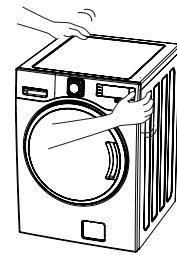

Operating your washer

To obtain the best washing results, you must operate your washer properly. This section gives you this important information.

Preparing clothes for washing

- Remove pins, buckles, coins and other hard objects from clothings, pockets, etc before putting the wash into the washing machine. Failing which can cause malfunction or damages to the drum assembly, pump and others.
- Close zippers, snaps, and hooks to avoid snagging other items.
Remove pin, buckles, and other hard objects to avoid scratching the washer interior.
- Empty pockets and pull them inside out.
- Turn down cuffs and turn synthetic knits inside out to avoid pilling.
- Tie strings and sashes to avoid tangling.
- Treat spots and stains. (See "Removing stains" on page 28)

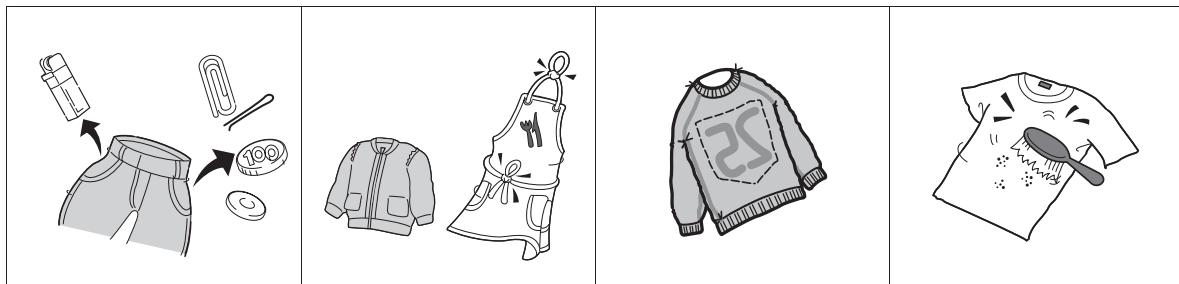

Operating your washer (cont.)

Sorting

- Separate heavily soiled items from lightly soiled ones, even if they would normally be washed together.
- Separate dark colors from light colors, colorfast items from non-colorfast item.

Soil (Heavy, Normal, Light)	Separate clothes according to amount of soil.
Color (White, Lights, Darks)	Separate white clothes from colored clothes.
Lint (Lint producers,Collectors)	Wash lint producers and lint collectors separately.

Loading

- Drop items into washer loosely. Items should move easily through wash water for best cleaning and wrinkle-free results.
- Load washer properly and select correct load size setting.
Overloading and selecting a setting too small for the wash load can :
 - Cause poor cleaning
 - Increase wrinkling
 - Create excessive lint
 - Wear out items faster (because of pilling)
- Mix large and small items in each load. Load evenly to maintain washer balance.
An unbalanced load can make the washer vibrate during spin.
- Reduce wash time when using a small load size setting. Load with only a few small items needs less wash time.
- Use a large load size setting to reduce wrinkling with permanent press clothes and some synthetic knits.
These items should have more room to move in the water than heavy items. (towels, jeans)



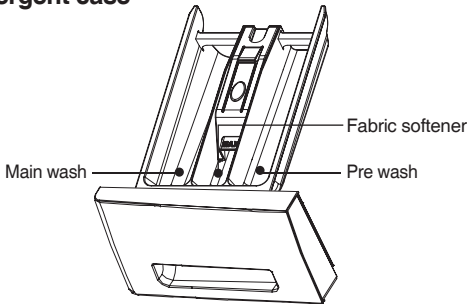





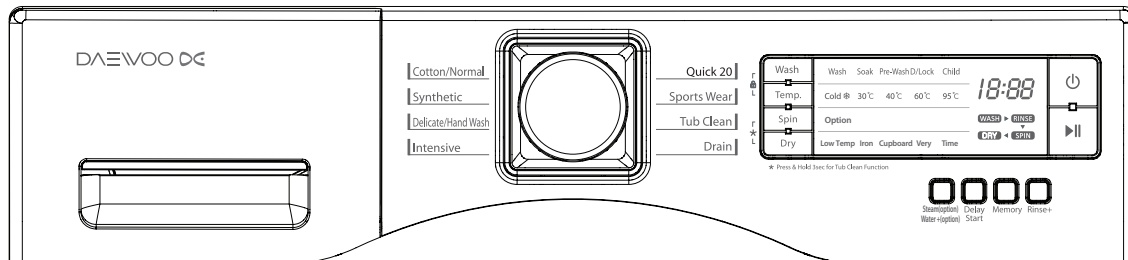

Adding detergent

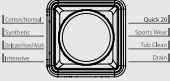
<p>Detergent case</p>  <p>Main wash</p> <p>Fabric softener</p> <p>Pre wash</p>	<p>Adding fabric softener</p> <ul style="list-style-type: none">• If desired, add measured liquid fabric softener to the softener inlet.• Pour liquid fabric softener into the dispenser using the amount recommended on the package.• Do not exceed the maximum fill line. Overfilling can cause early dispensing of the fabric softener which could stain clothes.• Do not open the detergent case when water is supplied.• Avoid pouring fabric softener directly on the clothes.
<ul style="list-style-type: none">• Please use only the powder detergent for the front loader washing machine.• Please use the proper amount of detergent in conformity with the instruction of the detergent manufacturer.• A use of a large amount of detergent more than the recommended amount can cause many soapsuds and the overload to the motor. In addition to, this will deteriorate the washing and rinse performance.	

The functions of the control panel

■ DWC-LD141X









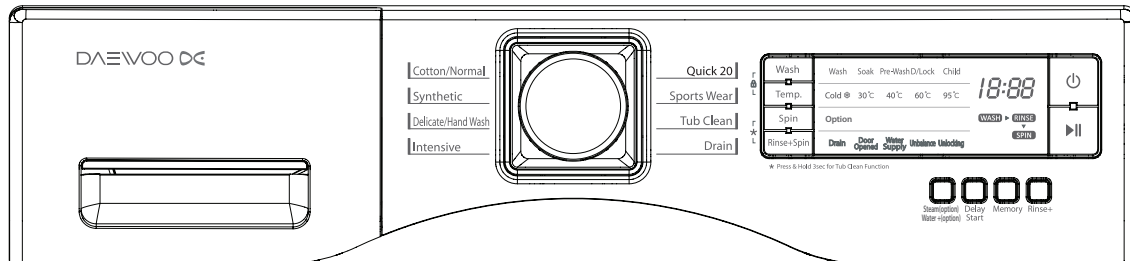

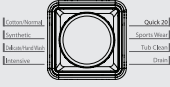

	<p>Press this switch to turn the power on or off.</p>
	<p>Operation and temporary stop is repeated as it is pressed. When you want to change program in operating; press the “Start/Pause” button → Select the program that you want to change → press the “Start/Pause” button again.</p>
	<p>You can select the course you want, and each lamp is turned on when that course is selected. For the more detailed information, please refer to the page 14~21.</p>
	<p>It can be used to adjust temperature of water according to types of the load to be washed. As the button is pressed, temperature of water is selected by Cold → 30°C → 40°C → 60°C → 95°C</p>
	<p>By pressing the spin button, the spin speed can be chosen. If press "spin button" spin RPM change.</p>
	<p>You can select the course you want, and each lamp is turned on when that course is selected. As the button is pressed, the wash course is selected by Wash → Soak → Pre-Wash</p>
	<p>You can select the course you want, and each lamp is turned on when that course is selected.</p>
	<p>It can be used to pre-engage time for wash.</p>
	<ul style="list-style-type: none"> • Steam - During washing time Steam is sprayed in Drum. Laundry is more clean. • Water + - If you want to use more water, press this button.
	<p>Use to memory program you want.</p>
	<ul style="list-style-type: none"> • Is used to add a rinse, which may assist in removing traces of detergent residue. • By selecting Rinse+ function, the rinse time and the rinse water are increased.

The functions of the control panel (cont.)

■ DWD-LD141X



	<p>Press this switch to turn the power on or off.</p>
	<p>Operation and temporary stop is repeated as it is pressed. When you want to change program in operating; press the "Start/Pause" button → Select the program that you want to change → press the "Start/Pause" button again.</p>
	<p>You can select the course you want, and each lamp is turned on when that course is selected. For the more detailed information, please refer to the page 14~21.</p>
	<p>It can be used to adjust temperature of water according to types of the load to be washed. As the button is pressed, temperature of water is selected by Cold → 30°C → 40°C → 60°C → 95°C</p>
	<p>By pressing the spin button, the spin speed can be chosen. If press "spin button" spin RPM change.</p>
	<p>You can select the course you want, and each lamp is turned on when that course is selected. As the button is pressed, the wash course is selected by Wash → Soak → Pre-Wash</p>
	<p>You can select the rinse+spin condition you want and each lamp is turned on when that course is selected.</p>
	<p>It can be used to pre-engage time for wash.</p>
	<ul style="list-style-type: none"> • Steam - During washing time Steam is sprayed in Drum. Laundry is more clean. • Water + - If you want to use more water, press this button.
	<p>Use to memory program you want.</p>
	<ul style="list-style-type: none"> • Is used to add a rinse, which may assist in removing traces of detergent residue. • By selecting Rinse+ function, the rinse time and the rinse water are increased.

Washing procedure and program selection

1. Cotton is automatically selected upon power on

- Press the Power button to start.
- Press the Start/Hold button
- Initial condition
 - Program : Cotton
 - Wash : main wash
 - Rinse : 3 times
 - Spin : 800
 - Water temperature : 40°C

2. MANUAL SELECTING

- Press the Power button to start
- Select the conditions which you want to use by turning the program dial and pressing each button.
- Press the Start/Pause button.

3. Reserved washing

- Reservation can be made from 1 hour to 12 hours.

example) To make reservation to complete washing in 8 hours.

- Procedure to press the button.

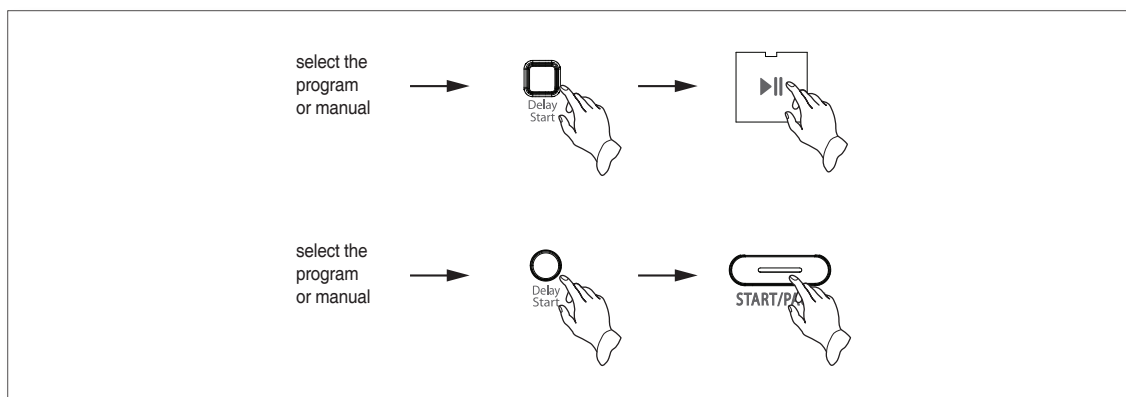

* Each pressing of the button advances time delay by one hour.

- Now the reservation is made.
- If you want to check the selected program, press the “Start/Pause” button again.
- Preparing washing before starting “Time Delay”;
 - Turn on the water tap
 - Load laundry and close the door
 - Place the detergent and fabric softener in the detergent case.
- To cancel the time delay, press the Power button.

Washing procedure and program selection (cont.)

4. FUNCTION

- Recommended programs according to the laundry type

Program	Fabric Type	Proper Temp.	Option	Maximum Load
Cotton/Normal	First check if laundry is machine washable.(white cotton, linen towel and sheets..)	60°C (Cold, 30°C, 40°C, 95°C)	Pre Wash Rinse+	Rating
	Colorfast garments (shirts, night dresses, pajamas..) and lightly soiled white cottons (underwear..)	40°C (Cold, 30°C, 60°C)	Pre Wash Rinse+	Rating
Synthetic	Polyamide, Acrylic, Polyester	30°C (Cold, 40°C)	Pre Wash Rinse+	Less than 3kg
Delicate/ Handwash	Delicate laundry easily damaged (silk, curtains..)	Cold		Less than 3kg
Intensive	Heavy soiled clothes (blue-jean, climbing clothes, ruck sack, sports wear,..)	60°C (Cold, 30°C, 40°C, 95°C)	Pre Wash Rinse+	Refer to rating label
Quick 20	Colored laundry which is lightly soiled fast.	Cold		Less than 3kg
Sports Wear	lightly soiled fast and thin laundry	Cold (Cold, 30°C, 40°C)	Pre Wash Rinse+	
Tub Clean	Use to clean (and dry for dry model)	Cold	dry for only Dry model	without load.
Drain	Drain water in drum to outside			

- **Pre Wash** : If the laundry is heavily soiled, “Pre Wash” program is recommended.
Pre Wash is available in Cotton and Synthetic programs.
- **Rinse+** : Used to introduce an additional rinse, which may assist in removing traces of detergent residue.

Washing procedure and program selection (cont.)

* COTTON/NORMAL PROGRAM

1	<p>Put the laundry in to the drum. Put detergent and softener into the detergent case. Then close the door.</p> <ul style="list-style-type: none">• Put detergent into the main wash and prewash compartments in the detergent case. Softener should be below the 'MAX' level.• Put detergent into the pre wash compartment only if you want to add prewash.• When you want to use bleach, put it into the main wash compartment with detergent.
2	<p>Press the Power button.</p> <ul style="list-style-type: none">• The LED shows only '---' and all Program Lights turn on.
3	<p>Select the 'Cotton/normal' program using program selection dial.</p> <ul style="list-style-type: none">• If you press Start/Hold button after power button without selecting program, the 'Cotton/normal' program is selected as default program.• Washing temperature '40' °C, spin '800' rpm are selected automatically.• If you want to change washing temperature, the spin velocity or add wash options (Rinse+, Pre-Wash), press each button.
4	<p>Press Start/Pause button.</p> <ul style="list-style-type: none">• The Door is locked. By sensing the weight of laundry and supplying wash water, The appliance starts washing.

NOTE

- If you want to change the setting during operation, press the Start/Pause button to hold the operation and press the button you want.
- 'Cold', '30' °C, '40' °C, '60' °C and '95' °C washing temperatures are selectable with Cotton/normal program.
- 'Prewash', 'Rinse+' wash options are selectable with Cotton/normal program.

CAUTION

- If you select washing temperature '95' °C, some cold water is supplied before the drain of main wash. This is to protect the user from the hazard of burn injury by lowering the temperature of hot wash water instead of directly draining it. Therefore this is not a malfunction.
(Be careful with the draining water, since it can be still hot although the temperature is lowered.)

Washing procedure and program selection (cont.)

* SYNTHETIC PROGRAM

1	<p>Put the laundry in the drum. Put detergent and softener into the detergent case. Then close the door.</p> <ul style="list-style-type: none">• Put detergent into the main wash and prewash compartments in the detergent case. Softener should be below the 'MAX' level.• Put detergent into the pre wash compartment only if you want to add prewash.• When you want to use bleach, put it into the main wash compartment with detergent.
2	<p>Press the Power button.</p> <ul style="list-style-type: none">• The LED shows only '---' and all Program Lights turn on.
3	<p>Select the 'Synthetic' program using program selection dial.</p> <ul style="list-style-type: none">• Washing temperature '30' °C, spin '800' rpm are selected automatically.• If you want to change washing temperature, the spin velocity or add wash options (Prewash, Rinse+), press each button.
4	<p>Press Start/Pause button.</p> <ul style="list-style-type: none">• The Door is locked. By sensing the weight of laundry and supplying wash water, The appliance starts washing.

NOTE

- If you want to change the setting during operation, press the Start/Pause button to hold the operation and press the button you want.
- Only 'Cold', '30' °C, '40' °C washing temperatures are selectable with Synthetic program.
- 'Prewash', 'Rinse+' wash options are selectable with Synthetic program.
- The appropriate amount of laundry for Synthetic program is below 3kg.

Washing procedure and program selection (cont.)

* DELICATE / HANDWASH PROGRAM

1	<p>Put the laundry in the drum. Put detergent and softener into the detergent case. Then close the door.</p> <ul style="list-style-type: none">• Put detergent into the main wash compartments in the detergent case. Softener should be below the 'MAX' level.• When you want to use bleach, put it into the main wash compartment with detergent.
2	<p>Press the Power button.</p> <ul style="list-style-type: none">• The LED shows only '---' and all Program Lights turn on.
3	<p>Select the 'Delicate / Handwash' program using program selection dial.</p> <ul style="list-style-type: none">• Washing temperature 'Cold', spin '400' rpm are selected automatically.
4	<p>Press Start/Pause button.</p> <ul style="list-style-type: none">• The Door is locked. By sensing the weight of laundry and supplying wash water, The appliance starts washing.

NOTE

- All programs are not selectable.
- The appropriate amount of laundry for Delicate program is below 3kg.

Washing procedure and program selection (cont.)

* INTENSIVE PROGRAM

1	<p>Put the laundry in the drum. Put detergent and softener into the detergent case. Then close the door.</p> <ul style="list-style-type: none">• Put detergent into the main wash and prewash compartments in the detergent case. Softener should be below the 'MAX' level.• Put detergent into the pre wash compartment only if you want to add prewash.• When you want to use bleach, put it into the main wash compartment with detergent.
2	<p>Press the Power button.</p> <ul style="list-style-type: none">• The LED shows only '---' and all Program Lights turn on.
3	<p>Select the 'Intensive' program using program selection dial.</p> <ul style="list-style-type: none">• Washing temperature '60' °C, spin '1000' rpm are selected automatically.• If you want to change washing temperature, the spin velocity or add wash options (Prewash, Rinse+), press each button.
4	<p>Press Start/Pause button.</p> <ul style="list-style-type: none">• The Door is locked. By sensing the weight of laundry and supplying wash water, The appliance starts washing.

NOTE

- If you want to change the setting during operation, press the Start/Pause button to hold the operation and press the button you want.
- All washing temperatures are selectable with Intensive program.
- 'Prewash', 'Rinse+' wash options are selectable with Intensive program.

Washing procedure and program selection (cont.)

* QUICK 20

1	<p>Put the laundry in the drum. Put detergent and softener into the detergent case. Then close the door.</p> <ul style="list-style-type: none">• Put detergent into the main wash compartments in the detergent case. Softener should be below the 'MAX' level.• When you want to use bleach, put it into the main wash compartment with detergent.
2	<p>Press the Power button.</p> <ul style="list-style-type: none">• The LED shows only '---' and all Program Lights turn on.
3	<p>Select the 'Quick' program using program selection dial.</p> <ul style="list-style-type: none">• Washing temperature 'Cold', spin '800' rpm are selected automatically.
4	<p>Press Start/Pause button.</p> <ul style="list-style-type: none">• The Door is locked. By sensing the weight of laundry and supplying wash water, The appliance starts washing.

NOTE

- All programs are not selectable with Quick 20 program.
- The appropriate amount of laundry for Quick 20 program is below 3kg.

Washing procedure and program selection (cont.)

* SPORTS WEAR PROGRAM

1	<p>Put the laundry in the drum. Put detergent and softener into the detergent case. Then close the door.</p> <ul style="list-style-type: none">• Put detergent into the main wash and prewash compartments in the detergent case. Softener should be below the 'MAX' level.• Put detergent into the pre wash compartment only if you want to add prewash.• When you want to use bleach, put it into the main wash compartment with detergent.
2	<p>Press the Power button.</p> <ul style="list-style-type: none">• The LED shows only '---' and all Program Lights turn on.
3	<p>Select 'Sports Wear' program using program selection dial.</p> <ul style="list-style-type: none">• Washing temperature 'Cold', spin '800' rpm are selected automatically.
4	<p>Press Start/Pause button.</p> <ul style="list-style-type: none">• The Door is locked. By sensing the weight of laundry and supplying wash water, The appliance starts washing.

NOTE

- If you want to change the setting during operation, press the Start/Pause button to hold the operation and press the button you want.
- Only 'Cold', '30°C and '40°C washing temperatures are selectable with Sports Wear program.

Washing procedure and program selection (cont.)

* TUB CLEAN PROGRAM

1	Press the Power button. • The LED shows only '---' signal.
2	Select the 'Tub Clean' program using program selection dial. • 'Soak' and spin '400' rpm and 'Cold' water temperature.
3	Press Start/Pause button. • The washer will be operated with locking Door and supplying water.

NOTE

- All programs are not selectable.
- Use this program WITHOUT load.
- The appropriate cleaning time is one time per a month.

Washing procedure and program selection (cont.)

* DRAIN PROGRAM

1	Press the Power button. <ul style="list-style-type: none">• The LED shows only '---' signal.
2	Select the 'Drain' program using program selection dial.
3	Press Start/Pause button. <ul style="list-style-type: none">• Drain program will start.

NOTE

- All programs are not selectable.

Guide for other useful programs

* DELAY START(RESERVED WASHING)

1	<p>Put the laundry into the Drum and put the detergent and softener into the detergent case. Then close the Door.</p> <ul style="list-style-type: none">• Put the detergent into the main wash room(I I marking) and prewash room(I marking) in the detergent case.• Softener should be below 'MAX' level.• Put the detergent into the pre wash room(I marking) only if you want to add prewash.• When you want to use bleach, put it into the main wash room (I I marking) with detergent.
2	<p>Press the Power button.</p> <ul style="list-style-type: none">• The LED shows only '- --' signal.
3	<p>Select the program by press the Delay Start button.</p> <ul style="list-style-type: none">• If you press 'Start/Pause' button after pressing Power button without selecting program, the 'NORMAL' program is selected as default program.• Select the 'Washing course' and 'Spin speed' and 'water temperature' by pressing each corresponding button.• The 'Time Delay' LED is to be lighting.• Select the time delay time you want from 1 hour to 12 hours by pressing button.• The displayed time shows program finishing time.
4	<p>Press the 'Start/Pause' button.</p> <ul style="list-style-type: none">• If you make this program successfully, only 'Time Delay' and 'Lock' LED are lighting.

NOTE

- If you want to check the selected program, press the 'Start/Pause' button again.
- Preparing washing before starting 'Time Delay';
 - Turn on the water tap.
 - Load laundry and close Door.
 - Place the detergent and fabric softner in the detergent case.
- The actual time of finishing is a little different with your selecting time because of water supply condition and selected water temperature,....
- 'DELICATE', 'Quick 20', 'Tub Clean' and 'Drain' program are not selected with 'Time Delay'.
- Adding clothes during 'Time Delay' operation is not allowed.

Guide for other useful programs (cont.)

* ONLY WASH

1	Put the laundry into the Drum and put the detergent and softener into the detergent case. Then close the Door.
2	Press the Power button. • The LED shows only '- --' signal.
3	Select the 'WASH COURSE' you want by pressing 'Wash' button. • The water temperature is selected to 'Cold' automatically.
4	Press the 'Start/Pause' button. • The washer will be operated with locking Door and supplying water.

* ONLY SPIN

1	Put the laundry into the Drum and close the Door.
2	Press the Power button. • The LED shows only '- --' signal.
3	Select the 'SPIN CONDITION' you want by pressing 'SPIN' button. • The water temperature is selected to 'Cold' automatically.
4	Press the 'Start/Pause' button. • The washer will be operated with locking Door.

Guide for other useful programs (cont.)

* DRY (FOR DWC-LD141X)

1	Put the laundry into the Drum and close the Door.
2	Press the Power button. • The LED shows only '- --' signal.
3	Select the 'DRY CONDITION' you want by pressing 'DRY' button. As this button is pressed, the dry condition is selected by 'Cupboard' → 'Very' → 'Time(1:00, 2:00, 3:00, 4:00)' → OFF → 'Low Temp' → 'Iron' → 'Cupboard'
4	Press the 'Start/Pause' button. • The washer will be operated with locking Door.

NOTE

- Do not use the detergent and softener.
- Cold water tap should be opened.
- After finishing this program,  is showed on PCB board alternately and the smoothing creases program is conducted during 30 minute and then power is OFF.
- 'DELICATE', 'Quick 20', 'Tub Clean' and 'Drain' program are not selected with 'DRY'.
- Be careful the high temperature of laundry when put out clothes.
- A little shrinkage and deformation will be possibly happened after drying, so check clothes whether dry or not previously
- If the dry performance is poor, change the selecting temperature.
- If you want to dry with wash, after selecting program, press the 'DRY' button then press 'Start/Pause' button.

Guide for other useful programs (cont.)

* RINSE+SPIN (FOR DWD-LD141X)

1	Put the laundry into the Drum and put softener into the detergent case. Then close the Door. <ul style="list-style-type: none">• Softener should be below 'MAX' level.
2	Press the Power button. <ul style="list-style-type: none">• The LED shows only '- --' signal.
3	Press the 'RINSE+SPIN' button. <ul style="list-style-type: none">• '800' rpm spin speed and 'COLD' water temperature are selected automatically.• If you want to change Spin condition, press each corresponding button.
4	Press the 'Start/Pause' button. <ul style="list-style-type: none">• The washer will be operated with locking Door.

NOTE

- The water temperature selecting is possible during this process.

Maintenance

Proper care of your washer can extend its life. This section explains how to care for your washer properly and safely.

Cleaning your washer

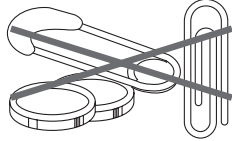
Exterior	Interior
<p>Wipe up detergent, bleach, and other spills with a soft, damp cloth or sponge as they occur. Occasionally wipe the outside of the washer to keep its looking like new one.</p> 	<p>Clean interior with 250ml of chlorine bleach mixed with 500ml of detergent. Run washer through a complete cycle. Repeat this process if necessary.</p>
<p>Remove pins, clips, coins, bolts, nuts, etc from pockets. Failing which can cause damage to the drum assembly, pump, etc.</p> 	

Winter storage or moving care

Install and store your washer where it will not freeze. Because some water may stay in the hoses, freezing can damage your washer.

If you store or move your washer during freezing weather, winterize it.

To winterize washer	To use washer again
<ul style="list-style-type: none">• Turn off water faucet.• Disconnect and drain water inlet hoses.• Run washer on a drain and spin setting (see page 10) for 1 minute.• Unplug the power supply cord.	<ul style="list-style-type: none">• Flush water pipes and hoses.• Reconnect water inlet hoses.• Turn on water faucet.• Reconnect power supply cord.

Non-use or vacation care

Operate your washer only when you are at home.

If you are on vacation or don't use your washer for an extended period of time, you should:

- Unplug the power supply cord or turn off electrical power to the washer.
- Turn off the water supplier to the washer.

This helps avoid accidental flooding (due to a water pressure surge) while you are away.

How to clean the filter

Cleaning the water inlet filter

Clean the filter when water leaks from the water inlet.

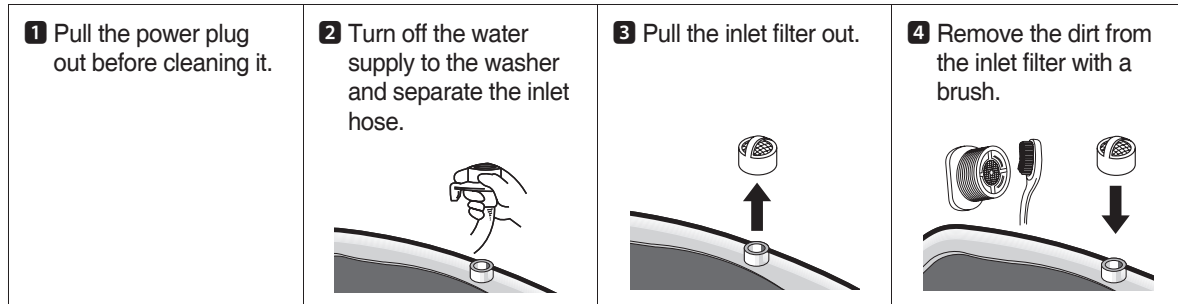

Cleaning the drain filter

- This drain filter is used to screen the foreign stuffs such as threads, coins, pins, buttons etc..
- If the drain filter is not cleaned at proper time (every 10 times of use), drain problem could be caused.

CAUTION Be careful when draining if the water is hot.

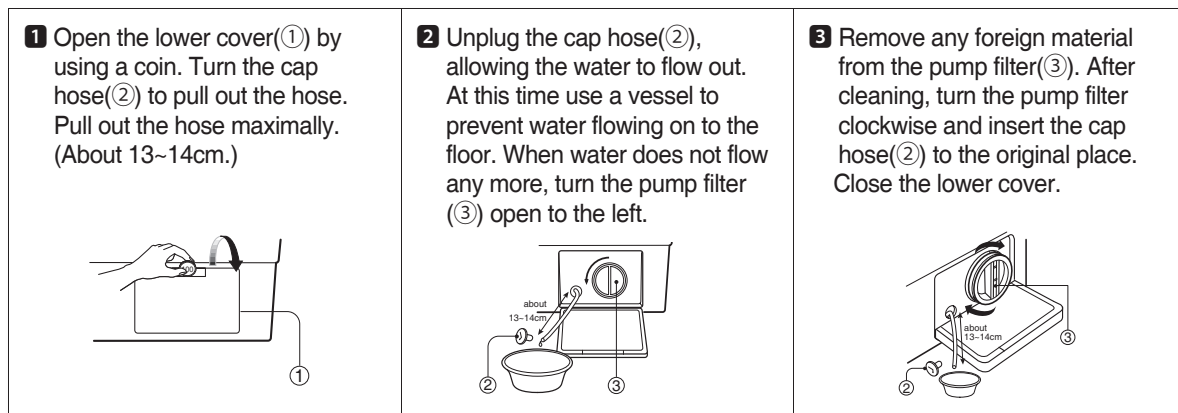

Cleaning the detergent case

- * After a while detergent and fabric softeners leave a deposit in the case;
- It should be cleaned from time to time with a jet of running water.
- If necessary it can be removed completely from the machine by pressing the catch downwards and by pulling it out.
- To facilitate cleaning, the upper part of the fabric softener compartment can be removed.

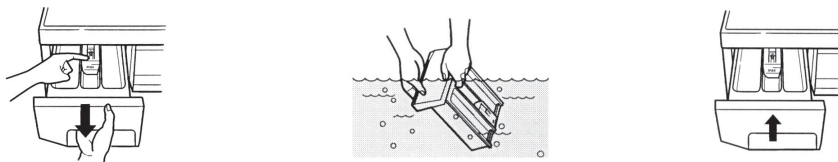

- * Detergent can also accumulate inside the recess which should be cleaned occasionally with a brush.
- * Once you have finished cleaning, replace the case and run a rinse cycle without laundry.

Removing stains

Stained, heavily-soiled, or greasy items may need to be prewashed or soaked for best results. Soaking helps remove protein-type stains like blood, milk or grass. Prewashing helps loosen soil before washing.

Stain removal rules

- Use warm water for soaking or prewashing stained laundry. Hot water can set stains.
- Most stains are easier to remove when they are fresh.
- Before treating any stain, find out what kind of stain it is, how old the stain is, what kind of fabric it is, and whether the fabric is colorfast. (Check the care label)
- Washing and drying can set some stains.
- Start with cold or warm water. Hot water can set some stains.
- When bleach is recommended, use a bleach that is safe for the fabric.
- Put the stained area face down on a paper towel or white cloth. Apply the stain remover to the back of the stain. This forces the stain off fabric instead of through it.

Stain removal guide

STAIN	TO REMOVE
Blood	Rinse immediately in COLD water. If stain remains, soak in cold water with an enzyme prewash.
Chewing gum	Use ice in plastic bag to harden the gum. Scrape off what you can and the sponge with white spirits.
Cocoa, Chocolate	Sponge with COLD water and soak in an enzyme prewash. If stains persist, rub in a little detergent and rinse in cold water.
Coffee	Blot up quickly and rinse out in COLD water. Rub in a little detergent and wash in the maximum temperature allowed for the fabric type.
Cream/Milk Ice cream	Rinse in COLD water and wash normally. If stain is still apparent, sponge with white spirits.
Deodorant	Rub affected area with white vinegar and then rinse out in COLD water. Sponge with white spirits. Treat stiffened areas with enzyme prewash.
Egg	Soak in a COLD enzyme prewash, rinse and wash normally.
Fabric/Softener	Rub affected area with bar soap and wash normally.
Fruit stains	Treat as soon as possible by sponging with COLD water. Rub a little detergent on the stain and wash normally.
Grass	Sponge with white spirits. Rub in an enzyme prewash and wash as normally.
Grease and oil	Lay the affected area face down on an absorbent cloth and work from the back. Sponge with white spirits or dry cleaning fluid. Wash normally.
Iron or rust	Apply lemon juice and salt and place in the sun. Wash normally.
Lipstick	Sponge with white methylated spirits and wash normally.
Mildew	Wash in WARM water and detergent. Moisten area with lemon juice, dry in the sun and wash normally. If stain persists and the fabric allows, use a bleach.
Mud	Brush off any dry mud. Rinse in cold water. If stain persists rub in a little detergent and wash normally.
Paint-oil based	Scrape off any fresh paint and sponge with a non flammable dry cleaning fluid and wash normally.
Paint-water based	Treat while still wet, rinse in WARM water and wash normally.
Scorch marks	Dampen a cloth with hydrogen peroxide, lay it over the affected area and press with a fairly hot iron.

Trouble shooting

Most problems are easily solved if you understand the cause.

Check the following list for problem before calling for service.

If the error mode such as IE, OE, UE were displayed on the control part, in order to solve these problem, first turn off the power of the washing machine and then turn on the power pressing Power button.

If PFE error mode was displayed on the control part, in order to solve this problem, first turn off the power of the washing machine, second turn on the power pressing Power button, third press SPIN button and last press Start/Pause button.

PROBLEM	CHECK POINT
<ul style="list-style-type: none"> The washer will not operate at all. 	<ul style="list-style-type: none"> Is there a power failure? Is the power cord correctly connected to an electric outlet? Did you turn on the power? Did you press Start/Pause button? Is there correct amount of laundry in the washer?
<ul style="list-style-type: none"> Water is not supplied <p>Error display IE</p>	<ul style="list-style-type: none"> Did you connect the inlet hose and open the water tap? Is the inlet hose or the water tap frozen? Is the water supply shot off? Is there any foreign matter blocking up the inlet hose filter?
<ul style="list-style-type: none"> The washer will not drain <p>Error display OE</p>	<ul style="list-style-type: none"> Is the drain hose frozen or blocked up by dirt? Is the drain hose kinked or deformed? Is the end of the drain hose immersed in water? Is there excessive dirt inside the drain filter?
<ul style="list-style-type: none"> The washer will not spin <p>Error display UE</p>	<ul style="list-style-type: none"> Is the clothes in the drum collected on one side? Is the washer installed on an uneven floor or is the vibration serious? Is the door open? (The lamp "LE" will light up in this case.)
<ul style="list-style-type: none"> The washer will stop during spinning . Spinning is insufficient. <p>Error display PFE</p>	<ul style="list-style-type: none"> Is the filter of the drain pump clogged? Is the drain pump operated? Did you use the proper amount of detergent? Is the drain hose placed higher than 1m above floor?
<ul style="list-style-type: none"> Vibrating and too noisy 	<ul style="list-style-type: none"> Is the washer installed on an uneven floor? Have all the transit bolts removed?

These cases are not malfunctions;

- The sound "wing" heard during water supply is the operating sound made by the water inlet valve.

Specification

MODEL	DWC-LD141X	DWD-LD141X
Dimension (mm)	600 X 645 X 850	
Maximum mass of textile (kg)	8.5Kg	
Unit Weight (net/gross)	76/80	69/73
Standard Water Consumption	67 ℓ	
Spin Speed (RPM)	MAX 1400	
Operating Water Pressure	0.03MPa ~ 0.8MPa (0.3kgf/cm ² ~ 8kgf/cm ²)	

Wiring diagram

■ DWC-LD'S

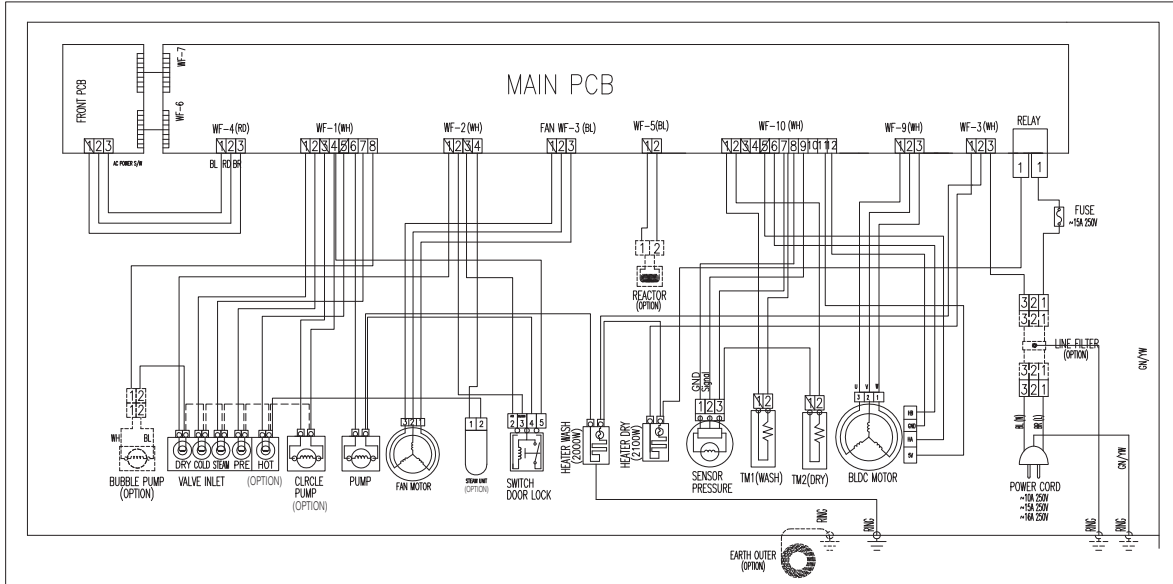

■ DWD-LD'S

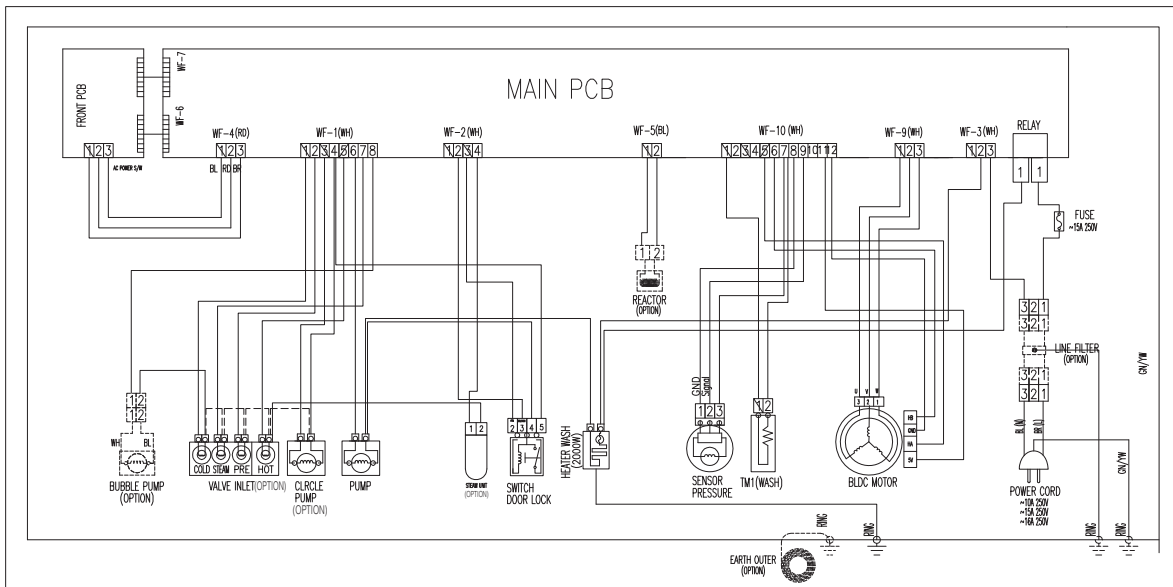

ABOUT THIS MANUAL

VISION CREATIVE. INC.
 서울 중로구 통의동
 6번지 이룸빌딩 4층

담 당	윤태원 님		
F.MODEL	WASH ONLY : D-LD1411EFA COMBO : C-LD1412EFA	BUYER	CASTEL
B.MODEL	WASH ONLY : DWD-LD1411(DWD-LD121X) COMBO : DWC-LD1412(DWC-LD141X)	BRAND	대우일렉
언 어	영어	COUNTRY	호주
일 정	1차		
	2차		
	3차		
	4차		
	5차		
제 판		인 쇄	애드컴
규 격			
MEMO 접수 : WASH ONLY, COMBO 2 모델 합본 (총 34p) 100115 - 신규 총 8p(표지,2,10,11,12,24,25,30) 100219 - 수정 총 3p(4,8,26) 100303 - 수정 총 1p(4) (총 31p) 100420 - 수정 총 2p(표지,30)			

연락처
 VISION 담 당방문수(chois).....
 TEL : 730-0660 FAX : 730-3788

Free Manuals Download Website

<http://myh66.com>

<http://usermanuals.us>

<http://www.somanuals.com>

<http://www.4manuals.cc>

<http://www.manual-lib.com>

<http://www.404manual.com>

<http://www.luxmanual.com>

<http://aubethermostatmanual.com>

Golf course search by state

<http://golfingnear.com>

Email search by domain

<http://emailbydomain.com>

Auto manuals search

<http://auto.somanuals.com>

TV manuals search

<http://tv.somanuals.com>