

DAEWOO

INSTRUCTION MANUAL

Model: DWF-5510

TABLE OF CONTENTS

■ SAFETY INSTRUCTIONS & SPECIFICATIONS	2
■ PARTS DESCRIPTIONS.....	3
■ DIRECTIONS FOR SAFE USE	4
•How To Install.....	4
•Water Connection	6
•Drain Hose Setting.....	7
■ HOW TO OPERATE	8
• Preparation for Washing	8
• Descriptions of Control Panel	9
• General Procedures for Operation	10
• Guides for Basic Washing Programs	11
• Guides for Other Useful Programs	13
■ PERIODIC MAINTENANCE	14
■ SPECIAL GUIDES FOR REMOVING STAINS ...	16
■ TROUBLE SHOOTING GUIDES.....	17

※ PLEASE READ CAREFULLY THIS INSTRUCTION MANUAL BEFORE USING YOUR WASHER AND SAVE THIS FOR FUTURE REFERENCE.

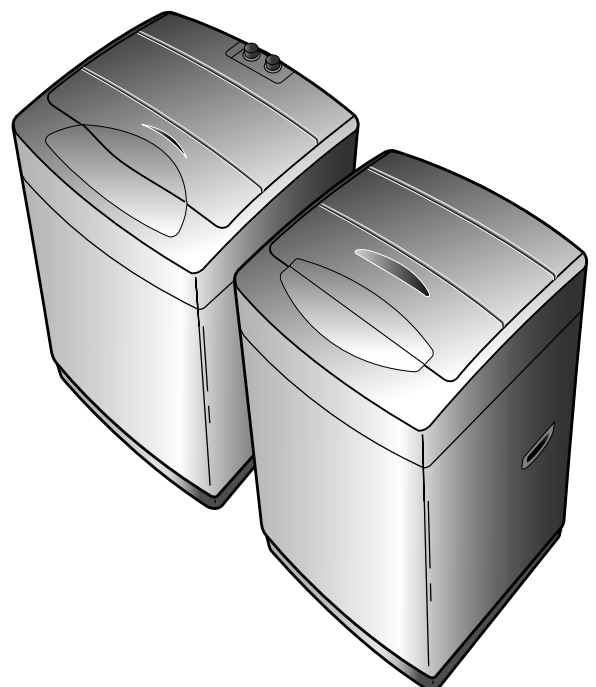

SAFETY INSTRUCTIONS & SPECIFICATIONS



SAFETY INSTRUCTIONS

※ Your safety is important to us. ※

Read all instructions before using your washer.

☞	Do not wash items cleaned, washed, soaked in, or spotted with wax, paint, gasoline, oil, or other flammable fluids. The fumes can create a fire hazard or explosion.
☞	Flammable fluids (dry-cleaning solvents, kerosene, gasoline, etc.) should not be used or stored in or near your washer. Do not add flammable fluids to your wash water. These substances give off vapors that can create a fire hazard or explosion.
☞	Do not allow children to operate, play with, or crawl on or inside your washer. Supervise children closely when your washer is used near them.
☞	Do not reach into the wash tub unless START/HOLD button is pressed and all motion stops, while spinning.
☞	Do not use chlorine bleach and ammonia or acids (such as vinegar or rust remover) in the same wash. Hazardous fumes can form.
☞	Unplug power supply cord before attempting to service your washer.
☞	Do not pour water on the control panel.
☞	Remove foreign objects (such as coin, pin, knife, other metallic materials, etc.) inside your wash load. They may damage any fabric.
☞	Do not overload your washer to avoid poor cleaning, wrinkling and/or any abnormal operation.



SPECIFICATIONS

MODEL NO	DWF-5510							
Power Source	Please refer to the rating label at the back of your washer.							
Power Consumption	250W							
Width X Depth (mm)	532 X 542							
Height (mm)	855							
Net Weight (Kg)	32							
Maximum Mass of Textile	5.5kg							
Material of Internal Tub	Recyclable Poly Propylene							
Water Consumption	Approx. 135 Liters/Cycle							
Washing Capacity	Please refer to the rating label at the back of your washer.							
Washing Program	4 Programs							
Water Level	High (55 Liters), Medium (45 Liters), Low (31 Liters)							
Direction of Inlet Valve	Backward							
Operating Water Pressure	0.3Kgf/cm ² ~8Kgf/cm ² (2.94N/cm ² ~78.4N/cm ²)							
Pulsator	Provided with 6 Spouting Holes for Powerful Upward Water Stream							
Optional Features	1. Air Bubble Generator							
	2. Reserved Washing with Display for remaining time							
	3. Signal Buzzer for the Operation of Control Button							
Coin Filter	Only in Pump Model identified with 'P' added to Model No. (e.g., DWF-5510NP)							

※ The above specifications and features are subject to change without prior notice.

PARTS DESCRIPTIONS

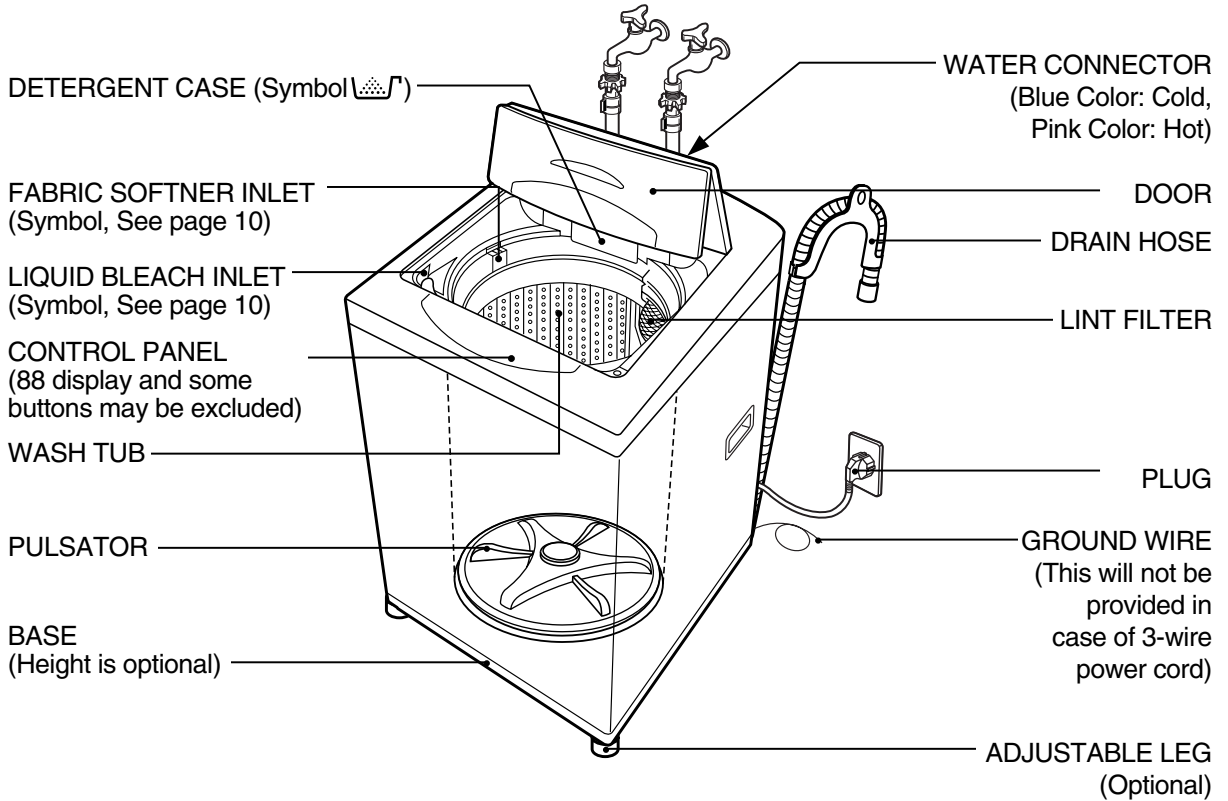

◆ The drawings in this book may vary from your washer model. They are designed to show the different features of all models covered by this book. Your model may not include all features.

ACCESSORIES

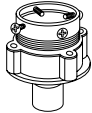
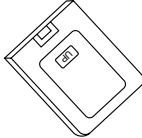
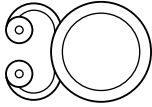
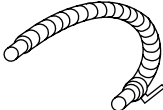
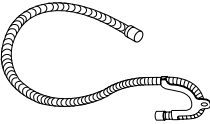
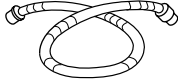
Dryten (option)	Hose Adapter	Under Cover (option)	Hose Clamp
	 In case of screw-shaped inlet hoses water tap adapters will not be provided.		
Drain Hose		Inlet Hose (option)	
 Non-Pump Model	 Pump Model		

DIRECTIONS FOR SAFE USE

HOW TO INSTALL

Location

Place your washer on a level and solid floor, considering the length of inlet hose, drain hose and power supply cord.

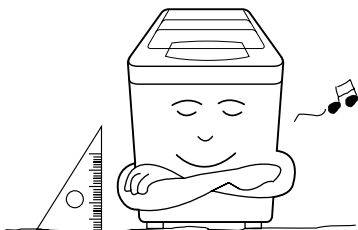

Do not place or store your washer below 0°C(32°F) to avoid any damage from freezing.

Do not place your washer where it may be splashed during bathing.

If washer is not level, it should be corrected by the adjustable leg (provided optionally) in the front-right side under the base and/or, a thin block or brick.

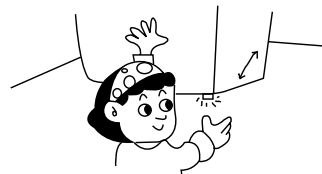

NOTES:

The opening must not be obstructed by carpeting when the washing machine is installed on a carpeted floor.

Installation of the Under Base Cover (Option) -DWF-5510

- 1 Before installing your washer, remove the pad from the bottom of the cabinet. Then, separate under cover from rear side of cabinet by unscrewing and insert it into the base.

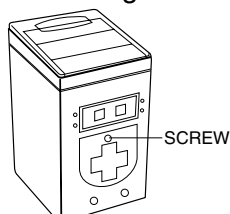

After installing the washing machine, assemble the under-base cover.

- 2 Push the under-base cover into the end, which decrease the noise made by this washer.

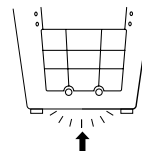

Power Supply

* Before plugging the plug into wall receptacle, check the voltage rating is in the range of rating, marked on the label at the back side of your washer.

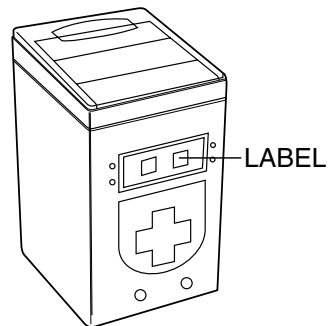

Grounding

• If your water tap or water pipe is not made of metal, connect the ground wire to a copper plate or a metal rod and bury it in the earth.

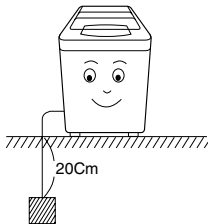

• If both your water tap and water pipe are made of metal, connect the ground wire to the base of the water tap.

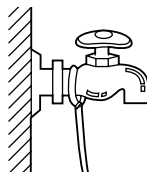

• It is of no use connecting the ground wire to the water pipe made of plastic.

• In case of using 3-core cord, there is no need for grounding.

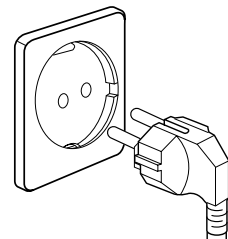

Never Connect the Ground Wire to Such a Thing

• Never connect it to a gas pipe because of danger of a explosion.

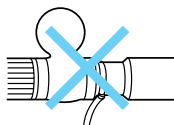

Gas Pipe

• Never connect it to a telephone wire or a lightning rod because of os very dangerous at a thunderbolt.



Telephone Wire

WATER CONNECTION

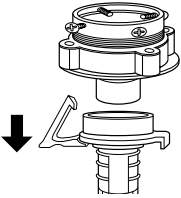
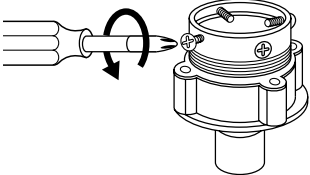
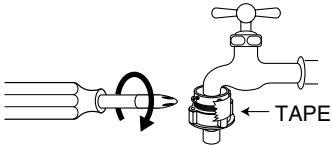
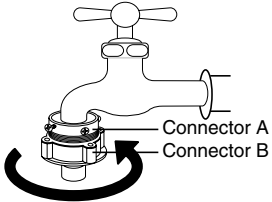
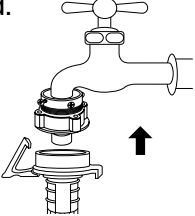
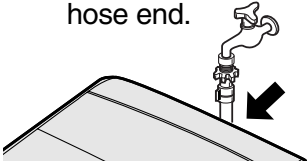

Be careful not to confuse hot water inlet (pink color) and cold water inlet (blue color), if your washer is provided with dual water inlets.
Also if you have only one water tap, connect the inlet hose with cold water inlet (blue color).

For normal tap

<p>① Pull down the collar of the inlet hose to separate it from the hose adapter.</p> 	<p>② Loosen the four screws properly in fitting into water tap.</p> 	<p>③ Fit the hose adapter into the water tap and tighten the four screws evenly while pushing up the adapter so that the rubber packing can stick to the water tap tightly.</p> 
<p>④ Remove the tape, and screw connector B into connector A tightly.</p> 	<p>⑤ Connect the inlet hose to the hose adapter, pulling down the collar of hose end.</p> 	<p>⑥ Connect the opposite end of the hose to water inlet of your washer tightly.</p> <ul style="list-style-type: none"> • Please check the rubber packing is inside the hose end. 

* In case that your washer is not provided with collar compartment, procedure ③ and ⑤ is not necessary.

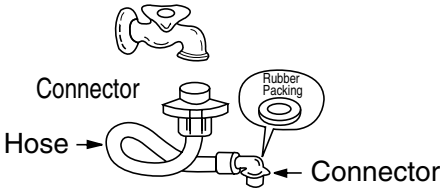
For Thread-Fitting Type

<p>① Connect the inlet hose to the thread of water tap or water pipe by tightening.</p> 	<p>② For the opposite end, connect it to water inlet as the above procedure ⑥.</p> 
---	---

Leak Test

Turn on the water completely to check for any leakage. If any leakage, turn off the water, try again as the above procedures.
For the special tap, call a qualified plumber for the installation.

DRAIN HOSE SETTING

Before operating your washer, install drain hose properly.

First, connect the drain hose to the drain outlet at the rear side of your washer, and then fasten it tightly with the hose clamp.

Next, the other end of drain hose set as the below.

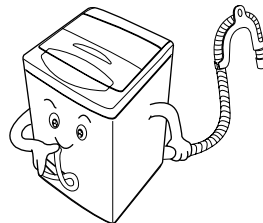

Pump Model

- ① Connect the drain hose to the drain outlet at the rear side of the washing machine, and fasten it tightly with the clamp supplied.

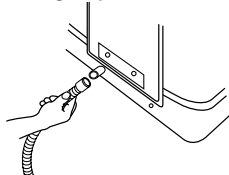

- ② Attach the hose guide included in the accessory kit, to guide the drain hose over the tub or standpipe.

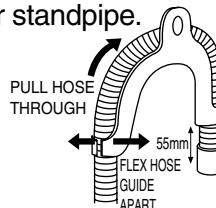

- ③ Hook the drain hose to the edge of the tub, paying attention that there are no bends or constrictions along the drain hose.

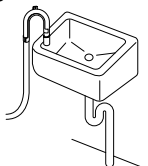

Or, connect the drain hose to a standpipe of a diameter greater than that of the drain hose and at a height of min. 70cm.

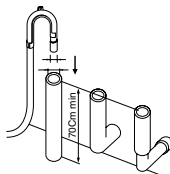

- ④ Attach the hose guide included in the accessory kit, to guide the drain hose over the tub or standpipe.

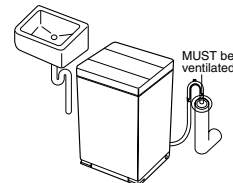

NOTES

- Let the highest point of the drain hose be more than 1m above the floor. If not so, the water in the washer could be drained during operation.
- Be sure that the height of the drain hose must be less than 1.4m above the floor. If not so, the water in the washer could not drain.
- The hose guide **MUST** be fitted to the drain hose. The drain hose should not extend more than 55mm from the end of the hose guide. This is to prevent 'SYPHONING'. If necessary the drain hose can be trimmed to length.

Non-Pump Model

- ① In case that it goes over a door sill. Don't let the height of the drain hose exceed 20cm from the ground.

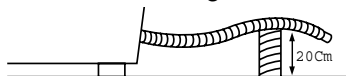

- ② In case of extending the drain hose. Don't let the total length exceed 3m.

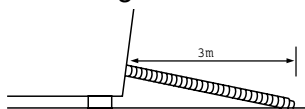

- ③ Be careful that the end of the drain hose is not immersed in water.

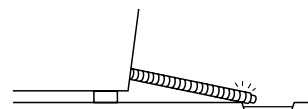

HOW TO OPERATE



PREPARATION FOR WASHING

To obtain the best washing results, you must operate your washer properly. This section give you this important information.

Preparing clothes for washing	
<ul style="list-style-type: none">• Close zippers, snaps, and hooks to avoid snagging other items. Remove pins, buckles, and other hard objects to avoid scratching the washer interior.• Empty pockets and turn them inside out.	<ul style="list-style-type: none">• Turn down cuffs and turn synthetic knits out to avoid pilling.• Tie strings and sashes so they will not tangle.• Treat spoats and stains. (see “Special Guides for Removing stains” on page)

Sorting
<ul style="list-style-type: none">• Separate heavily soiled items from, lightly soiled ones, even if they would normally be washed together.• Separate dark colors from light colors, colorfast items from non-colorfast item.







Loading	
<ul style="list-style-type: none">• Drop items into washer loosely. Items should move easily through wash water for best cleaning and wrinkle-free results.• Load washer properly and select correct load size setting. Overloading and selecting a setting too small for the wash load can:<ul style="list-style-type: none">- cause poor cleaning- increase wrinkling- create excessive lint- wear out items faster (because of pilling)	<ul style="list-style-type: none">• Mix large and small items in each load. Load evenly to maintain washer balance. An off balance load can make the washer vibrate during spin.• Reduce wash time when using a small load size setting. Loads with only a few small items need less wash time.• Use a large load size setting to reduce wrinkling with permanent press clothes and some synthetic knits. These items should have more room to move in the water than heavy items (towels, jeans)

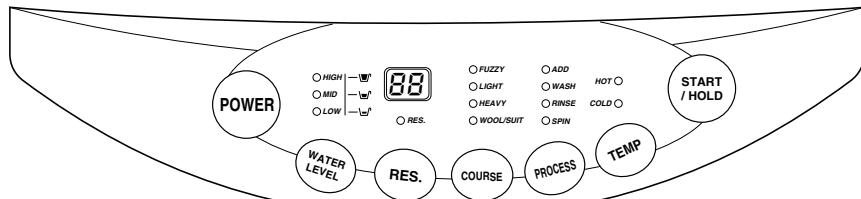

DESCRIPTIONS OF CONTROL PANEL

DWF-5510



	<p>Power Switch</p> <ul style="list-style-type: none"> • Press this button to turn the power ON or OFF.
	<p>Water Level Selector</p> <ul style="list-style-type: none"> • This button is used to select the water level you want.
	<p>Reservation Button</p> <ul style="list-style-type: none"> • If you want to reserve the finishing time of washing, use this button. As this button is pressed, digit in display increases by 1 hour at one press. • If current time is 8:00 am and you expect washing will be completed around 5:00 pm, press this nine times in order to display '9'.
	<p>Course Selector</p> <ul style="list-style-type: none"> • This button is used to select the washing course according to the type of wash loads. • Either Wool or Suit course is adopted to your Washing Machine.
	<p>Program Button</p> <ul style="list-style-type: none"> • With this button, you can create new programs by combinations of process.
	<p>Temperature Selector (Optional)</p> <ul style="list-style-type: none"> • If your washer is connected to two water taps for cold water and hot water, you can select them. Without operation, cold water would be selected automatically.
	<p>Start/Hold</p> <ul style="list-style-type: none"> • With this button, you can make your washer proceed your program, or stop temporarily. And you can also release the temporary stop by pressing this.



GENERAL PROCEDURES FOR OPERATION

1. Add measured detergent to the washer, (Follow manufacturer's directions for safe use)
2. OPTIONAL STEP

If desired, add measured liquid chlorine bleach to the bleach inlet. use only liquid chlorine in the bleach inlet

* Follow manufacturer's direction for safe use.

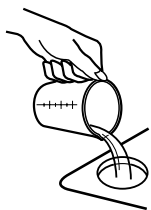

Bleach inlet
(Symbol)

NOTE

- Do not let bleach splash, drip, or run down into washer basket.
Undiluted bleach will damage any fabric it touches.
- Do not use this dispenser to add powdered chlorine or color safe bleach to your wash load. The dispenser is for liquid chlorine bleach use only.

3. OPTIONAL STEP

If desired, add measured liquid fabric softener to the softener inlet.

- Pour liquid fabric softener into the dispenser using the amount recommended on the package. Avoid dripping or spilling any fabric softener on the load.
- The dispenser is for liquid fabric softener use only.

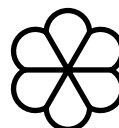
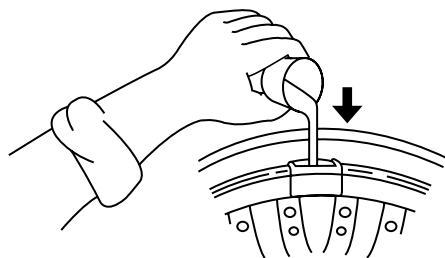

Softener inlet
(Symbol)



4. Close the washer lid (door)
5. Press the power button.
6. Select the course. The full automatic course has four settings; FUZZY, LIGHT, HEAVY, SUIT.
(See page 9)
7. Press the "START/HOLD" button.



GUIDES FOR BASIC WASHING PROGRAMS



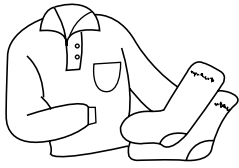

Fuzzy Course

- This course is a washing method for the general clothes except the extraordinary clothes such as blanket, wool, etc

<p>① Put in the clothes</p> 	<p>② Press the power switch.</p> 	<p>③ Press the Start/Hold button, and close the lid.</p> 
---	--	--





Light Course

- This course is effective for the washing of light clothes or lightly stained clothes.
- Regulate the water level according to the wash load.

<p>① Press the power switch.</p> 	<p>② Press the course selection button for "LIGHT"</p> <ul style="list-style-type: none"><input type="radio"/> FUZZY<input checked="" type="radio"/> LIGHT<input type="radio"/> HEAVY<input type="radio"/> WOOL 	<p>③ Select the water level proper to the wash load.</p> <ul style="list-style-type: none"><input type="radio"/> HIGH<input checked="" type="radio"/> MID<input type="radio"/> LOW 	<p>④ Press the Start/Hold button, and close the lid.</p> 
--	--	--	--





Heavy Course

- This selection is effective for blue-jean, climbing clothes, ruck sack, sports wear.

<p>① Press the power switch.</p> 	<p>② Press the course selection button for "HEAVY".</p> <ul style="list-style-type: none"><input type="radio"/> FUZZY<input type="radio"/> LIGHT<input checked="" type="radio"/> HEAVY<input type="radio"/> WOOL/SUIT 	<p>③ Select the water level proper to the wash load.</p> <ul style="list-style-type: none"><input type="radio"/> HIGH<input checked="" type="radio"/> MID<input type="radio"/> LOW 	<p>④ Press the Start/Hold button, and close the lid.</p> 
--	--	--	--







Wool Course (Option)

- This selection is effective for wool clothes.
(1.2kg's limitation for 1 time-wash)
- Do not put leather clothes, or chamois clothes into the washing tub for washing. It may cause shrinkage or deformation to the clothes.
- Please use the neutral detergents only.
- The water temperature is fixed to "COLD"
- The water level "LOW" is not select.

<p>① Press the power switch.</p> 	<p>② Press the course selection button for "WOOL"</p> <p>○ FUZZY ○ LIGHT ○ HEAVY ● WOOL</p> 	<p>③ Select the water level proper to the wash load.</p> <p>○ HIGH ● MID ○ LOW</p> 	<p>④ Press the Start/Hold button, and close the lid.</p> 
--	---	--	--

Suit Course (Option)

- This selection is effective for High-quality sweater, wool etc..
(1kg's limitation for 1 time-wash)
- Put in the wash market with "Dry Cleaning".
- Use detergent that is "Only for Dry Cleaning".
- The water temperature is fixed to "COLD".
- The water level "LOW" is not select.

		<p>① Press the power switch.</p> 	<p>② Press the course selection button for "SUIT".</p> <p>○ FUZZY ○ LIGHT ○ HEAVY ● SUIT</p> 
<p>③ Select the water level proper to the wash load.</p> <p>○ HIGH ● MID ○ LOW</p> 	<p>④ Press the Start/Hold button, and close the lid.</p> 	<p>⑤ Put the clothes into the tub after the buzzer sounds.</p> 	<p>⑥ Press the Start/Hold button, and close the lid.</p> 



GUIDES FOR OTHER USEFUL PROGRAMS

For the partial process or the combinations, or for adding time of each process.

step 1. Press power switch.

step 2. Press program button until the indicating lamps make the combinations you want.

If only spin lamp is turned on, that means you will operate your washer for spin only.





If rinse and spin lamp are turned on, that means you will operate your washer for rinse and spin.

If add lamp is turned on with other process lamps, that means the time of the corresponding

process will increase by 1~2 minutes, that is, if add is on with wash, rinse and spin, the time of each process will increase by 1~2 minutes. (Wash: add 2 min., Rinse: add 1 min., Spin: add 1 min.)

step 3. Press water level selector as your decision.

step 4. Press Start/Hold to start.

① Pressing the Power Switch	② Selecting Water level	③ Selecting Course			④ Pressing the Start/ Hold Switch	
	<input type="radio"/> HIGH <input type="radio"/> MID <input type="radio"/> LOW 	<input type="radio"/> ADD <input type="radio"/> WASH <input type="radio"/> RINSE <input type="radio"/> SPIN 	Wash & Rinse & Spin	<input type="radio"/> ADD <input checked="" type="radio"/> WASH <input checked="" type="radio"/> RINSE <input checked="" type="radio"/> SPIN		End of Washing
			Only Spin	<input type="radio"/> ADD <input type="radio"/> WASH <input type="radio"/> RINSE <input checked="" type="radio"/> SPIN		
			Add & Wash	<input checked="" type="radio"/> ADD <input checked="" type="radio"/> WASH <input type="radio"/> RINSE <input type="radio"/> SPIN		
			Add & Rinse & Spin	<input checked="" type="radio"/> ADD <input type="radio"/> WASH <input checked="" type="radio"/> RINSE <input checked="" type="radio"/> SPIN		
			Add & Spin	<input checked="" type="radio"/> ADD <input type="radio"/> WASH <input type="radio"/> RINSE <input checked="" type="radio"/> SPIN		
			Add & Wash & Rinse & Spin	<input checked="" type="radio"/> ADD <input checked="" type="radio"/> WASH <input checked="" type="radio"/> RINSE <input checked="" type="radio"/> SPIN		
			Only Wash	<input type="radio"/> ADD <input checked="" type="radio"/> WASH <input type="radio"/> RINSE <input type="radio"/> SPIN		
			Rinse & Spin	<input type="radio"/> ADD <input type="radio"/> WASH <input checked="" type="radio"/> RINSE <input checked="" type="radio"/> SPIN		
						It is Informed by buzzer.

For the reservation of finishing time

① Set your program as the above procedure, remaining last step.

- * Press the course selection button.
- * Press the procedure selection button.
- * But wool/suit course can not reservation.

② Press reservation button until the digital monitor displays the finishing time you want.



③ Press Start/Hold to start.



PERIODIC MAINTENANCE

Proper care of your washer can extend its life. This section explains how to care for your washer properly and safely.

Cleaning your washer

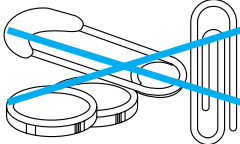
Exterior	Interior
<p>Wipe up detergent, bleach, and other spills with a soft, damp cloth or sponge as they occur. occasionally wipe the outside of the washer to keep it looking like new.</p> 	<p>Clean interior with 250ml of chlorine bleach mixed with 500ml of detergent. Run washer through a complete cycle. Repeat process if necessary.</p>
<p>Do not put sharp or metal object in your washer, they can damage the finish. Check all pockets for pins, clips, money, bolts, nuts, etc. Do not lay these objects on your washer after emptying pockets.</p> 	

Winter storage or moving care

Install and store your washer where it will not freeze. Because some water may stay in the hoses, freezing can damage your washer.

If storing or moving your washer during freezing weather, winterize it.

To winterize washer	To use washer again
<ul style="list-style-type: none"> • Shut off water faucet. • Disconnect and drain water inlet hoses • Run washer on a drain and spin setting (see page 13) for 1 minute. • Unplug the power supply cord. 	<ul style="list-style-type: none"> • Flush water pipes and hoses. • Reconnection water inlet hoses. • Turn on water faucet. • Reconnection power supply cord.

Non-use or vacation care



Operate your washer only when you are at home.

If will be on vacation or not using your washer for an extended period of time, you should:

- Unplug the power supply cord or turn off electrical power to the washer.
- Turn off the water supply to the washer.

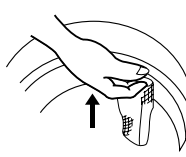
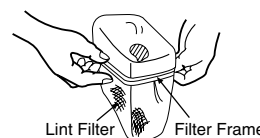

This helps avoid accidental flooding (due to a water pressure surge) while you are away.

Cleaning the Lint Filter

<p>① Pull the Filter frame upward.</p> 	<p>② Turn the lint filter inside out, wash to the lint off with water</p> 	<p>③ Return the filter as it was, and insert the filter frame into the slot</p> 
--	---	---

Cleaning the water inlet filter

- Clean the filter when water leaks from, the water inlet.

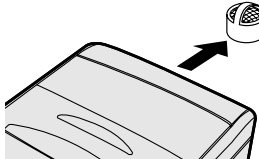
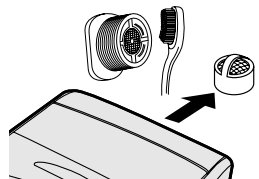
<p>① Pull the power plug out before cleaning it.</p> 	<p>② Turn off the water supply to the washer and sperate the inlet hose.</p> 	<p>③ Pull the inlet filter out.</p> 	<p>④ Remove the dirt from the inlet filter with a brush.</p> 
--	--	---	--

Cleaning the drain filter

- In case “U” shape drain hose, this filter’s equipped at the cack side of washer.
- This drain filter is to screen the foreign stuffs such as threads, coins, pins, buttons etc ...
- If the drain filter is not cleaned at proper time (every 10 times of use), Drain problem could be caused. see page

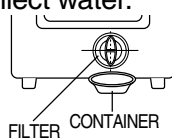
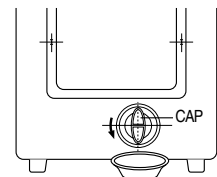
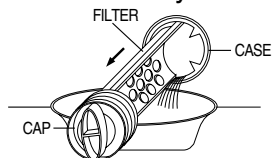
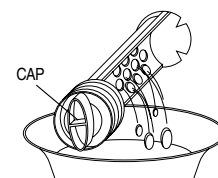
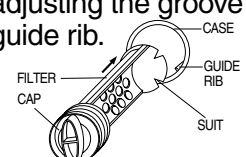
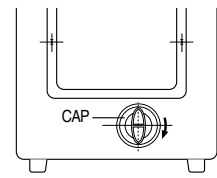
<p>① Put down the remained water in the hose. And put a container under the filter to collect water.</p> 	<p>② Turn the cap counter clockwise.</p> 	<p>③ Pull out the filter assembly off the case of the main body.</p> 
<p>④ Clean the drain filter removing the foreign stuffs.</p> 	<p>⑤ Put in the filter along the guiding prominence of the case. Please note the left position of the filter adjusting the groove to the guide rib.</p> 	<p>⑥ Turn the cap clockwise tightly.</p> 

SPECIAL GUIDES FOR REMOVING STAINS

Stained, heavily-soiled, or greasy items may need to be prewashed or soaked for best results. Soaking helps remove protein-type stains like blood, milk, or grass. Prewashing helps loosen soil before washing.

Stain removal rules

- Use warm water for soaking or prewashing stained laundry. Hot water can set stains.
- Most stains are easier to remove when they are fresh. Old or set stains may not come out.
- Before treating any stain, find out what kind of stain it is, how old the stain is, what kind of fabric it is, and if the fabric is colorfast. (Check the care label)
- Washing and drying can set some stains.
- Start with cold or warm water, hot water can set some stain.
- When bleach is recommended, use a bleach that is safe for the fabric.
- Put the stained area face down on a paper towel or white cloth. Apply the stain remover to the back of the stain. This forces the stain off fabric instead of through it.

Stain removal guide

STAIN	TO REMOVE
Blood	Rinse immediately in COLD water. If stain remains, soak in cold water with an enzyme prewash.
Chewing gum	Use ice in plastic bag to harden the gum. Scrape off what you can and then sponge with white spirits.
Cocoa, Chocolate	Sponge with COLD water and soak in an enzyme prewash. If stains persist, rub in a little detergent and rinse in cold water.
Coffee	Blot up quickly and rinse out in COLD water. Rub in a little detergent and wash in the maximum temperature allowed for the fabric type.
Cream/Milk Ice cream	Rinse in COLD water and wash normally. If stain is still apparent, sponge with white spirits.
Deodorant	Rub affected area with white vinegar and then rinse under running COLD water. Sponge with white spirits. Treat stiffened areas with enzyme prewash
Egg	Soak in a COLD enzyme prewash, rinse and wash normal.
Fabric/Softener	Rub affected area with bar soap and wash normally.
Fruit stains	Treat as soon as possible by sponging with COLD water. Rub a little detergent on the stain and wash normally
Grass	Sponge with white spirits. Rub in an enzyme prewash and wash as normal
Grease and oil	Lay the affected area face down on an absorbent cloth and work from the back. Sponge with white spirits or dry cleaning fluid. Wash normally.
Iron or rust	Apply lemon juice and salt and place in the sun. Wash normally.
Lipstick	Sponge with white methylated spirits and wash normally.
Mildew	Wash in WARM water and detergent. Moisten area with lemon juice, dry in the sun and wash normally. If stain persists and the fabric allows, use a bleach.
Mud	Brush off any dry mud. Rinse in cold water. If stain persists rub in a little detergent and wash normally.
Paint-oil based	Scrape off any fresh paint and sponge with a non flammable dry cleaning fluid and wash normally.
Paint-water based	Treat while still wet, rinse in WARM water and wash normally.
Scorch marks	Dampen a cloth with hydrogen peroxide, lay it over the affected area and press with a fairly hot iron.

TROUBLE SHOOTING GUIDES

Most problems are easily solved if you understand the cause. Check the following list for problem before calling for service.

Before calling for service, check these

PROBLEM	CHECK POINT
<ul style="list-style-type: none"> The washer will not operate at all. 	<ul style="list-style-type: none"> Is there a power failure? Is the power cord correctly connected to an electric outlet? Is the electric fuse broken? Did you turn on the power? Did you press Start/Hold button? Is there correct amount of water in the tub?
<ul style="list-style-type: none"> Water is not supplied; <p>If water supply is not finished within 30 minutes, the lamp LE will light up, and the buzzer will sound to indicate a problem.</p>	<ul style="list-style-type: none"> Did you connect the inlet hose and open the water tap? Is the inlet hose or the water tap frozen? Is the water supply shut off? Does foreign matter block up the inlet hose filter?
<ul style="list-style-type: none"> The washer will not drain; <p>If the drain is not finished within selected time, lamp LE will light up, and the buzzer will sound to indicate a problem.</p>	<ul style="list-style-type: none"> Is the drain hose frozen or blocked up by dirt? Is the drain hose kinked or deformed? Is the end of the drain hose immersed in water? Is there excessive dirt inside the pump housing?
<ul style="list-style-type: none"> The washer will not spin; <p>If the clothes is collected on one side during spin and the tub becomes unbalanced, the spin operation will be interrupted, and then this unbalanced condition will be corrected by following operation: WATER SUPPLY → RINSE → DRAIN However if the unbalanced condition is unchanged despite repeating the above operation, the lamp LE will light up, and the buzzer will sound to indicate a problem.</p>	<ul style="list-style-type: none"> Is the clothe in the tub collected on one side? Is the washing machine installed on an uneven floor or is the vibration serious? Is the lid open? (The lamp LE will light up in this case.)
<ul style="list-style-type: none"> These cases are not malfunctions The sound “wing” heard during water supply is the operating sound made by the water inlet valve. The sound “sha” heard in stopping the tub is the sound that comes from the autobalancer of the tub. The sound “wung” heard during wash or spin is the operating sound made by the air bubble generator. 	

*NOTE! *

Please check the point before calling for a service.

If the supply cord is damaged, it must only be replaced by a repair shop appointed by manufacturer, because special purpose tools are required.

Free Manuals Download Website

<http://myh66.com>

<http://usermanuals.us>

<http://www.somanuals.com>

<http://www.4manuals.cc>

<http://www.manual-lib.com>

<http://www.404manual.com>

<http://www.luxmanual.com>

<http://aubethermostatmanual.com>

Golf course search by state

<http://golfingnear.com>

Email search by domain

<http://emailbydomain.com>

Auto manuals search

<http://auto.somanuals.com>

TV manuals search

<http://tv.somanuals.com>