

**DIPLOMAT®**

**OWNER'S MANUAL**

**MANUEL  
D'UTILISATION**

**Model • Modèle**

**DPAC5070**

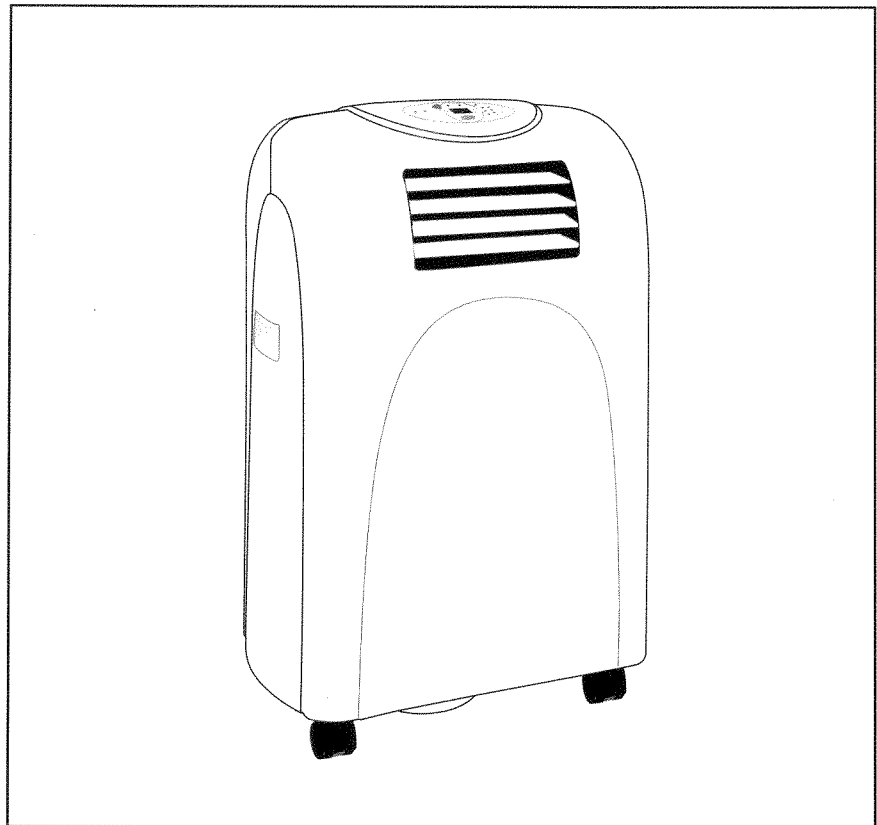

**CAUTION:**

Read and follow all safety rules and operating instructions before first use of this product.

**MISE EN GARDE :**

Veuillez lire attentivement les consignes de sécurité et les directives d'utilisation avant l'utilisation initiale de ce produit.

**PORTABLE AIR CONDITIONER**

**Table of contents ..... 1**

**CLIMATISEUR PORTATIF**

**Table des matières ..... 15**

***SAVE THESE INSTRUCTIONS!***

***SAUVEGARDER CES INSTRUCTIONS!***



Danby Products Ltd, PO Box 1778, Guelph, Ontario Canada N1H 6Z9  
Danby Products Inc, PO Box 669, Findlay, Ohio USA 45839-0669

Version 1.12.06.

## Table Of Contents

Introduction and Unit Specifications .....	2
Electrical and Important Safety Information .....	3
Energy-Saving Tips and Installation Accessories .....	4
Direct Drain Instructions .....	5
Window Kit Installation .....	6
Operating Instructions	
Features of the Control Panel .....	7
• Air Conditioning .....	8
• Fan Only & Dehumidifier .....	9
• Auto-Timer .....	10-11
Care and Maintenance .....	12
Warranty .....	13

## Unit Parts Identification

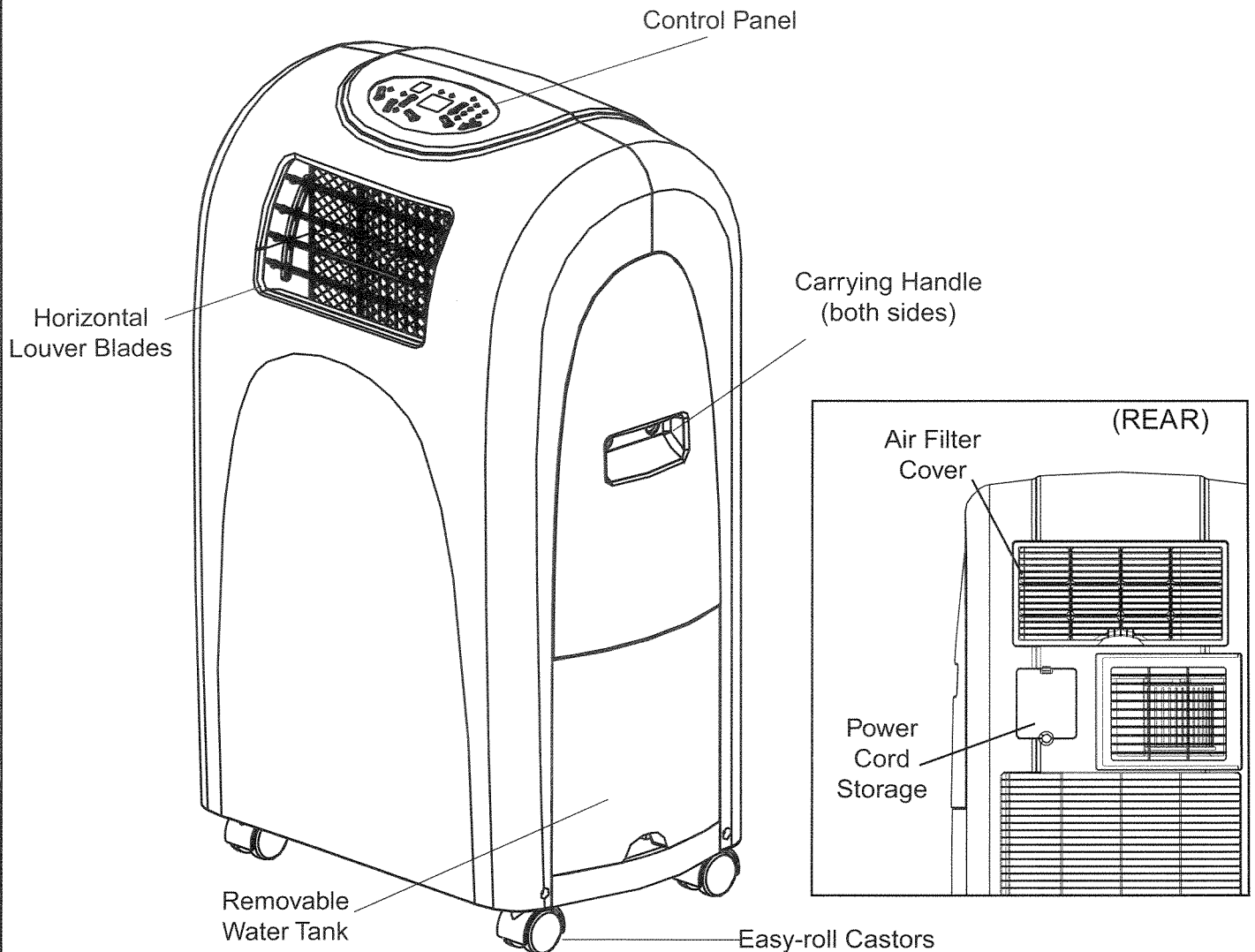

## Introduction

Thank you for choosing a Diplomat appliance to provide you and your family with all of the "Home Comfort" requirements for your home, cottage or office. This Owner's Manual will provide you with valuable information necessary for the proper care and maintenance of your new appliance. If properly maintained, your Diplomat appliance will give you many years of trouble free operation. Please take a few moments and read the instructions thoroughly and familiarize yourself with all of the operational aspects of this appliance.

Your Diplomat Portable Air-Conditioner is a multi-function room air-exchanging, air-processing appliance, designed to offer you the functions of Air Conditioning, Dehumidifying and Independent Fan. This unit can be conveniently moved from room to room within your home and set-up in just minutes. Imagine the convenience of Portable Home Comfort at your fingertips, anytime, anywhere.

For easy reference, may we suggest you attach a copy of your sales slip/receipt to this page, along with the following information which is located on the manufacturers nameplate located on the rear panel of the unit.

Model Number: DPAC5070

Serial Number: \_\_\_\_\_

Date of Purchase: \_\_\_\_\_

Dealer's Name and Address: \_\_\_\_\_

This information will be required if your unit requires servicing and/or for general inquiries. To contact a Customer Service Representative, call Danby TOLL FREE. 1-800-26-DANBY

Unit Specifications	
Model Number	DPAC5070
Cooling Capacity	5000 Btu/h
Noise Level	54 dB
Fan Speeds	3
Airflow CFM High / Medium / Low	280 / 240 / 210
Power Source	115 V / 60 Hz
Refrigerant	R22
Internal Reservoir Capacity	3 Liters (6.3 Pints)
Unit Weight	26 kg (57.2 lb.)
Unit Dimensions (inches) W x D x H	17-2/16" x 13-3/16" x 29"
Unit Dimensions (mm) W x D x H	435 x 335 x 737
Remote Control	No
Time of Day Clock	No
Auto - Timer	Yes

NOTE: *Continuing research results in steady improvement. Therefore, this information and these specifications are subject to change without notice.*

## Electrical Specifications

1. Check available power supply and resolve any wiring problems BEFORE installation and operation of this unit. All wiring must comply with local and national electrical codes and be installed by a qualified electrician. If you have any questions regarding the following instructions, contact a qualified electrician.
2. This appliance draws 4.6 nameplate amps under **Cooling Mode** and may be used in any properly wired, general purpose 15 amp household grounded receptacle.
3. For your safety and protection, this unit is grounded through the power cord plug when plugged into a matching wall outlet. If you are not sure whether the wall outlets in your home are properly grounded, please consult a qualified electrician.

**WARNING!** : *Improper connection of the grounding plug can result in a risk of; Fire, Electric Shock and/or Injury to Persons associated with the Appliance. Check with a qualified electrician or service representative if you are in doubt that the appliance is properly grounded.*

4. **DO NOT USE PLUG ADAPTERS OR REGULAR EXTENSION CORDS WITH THIS UNIT.** If it is necessary to use an extension cord with this unit, use an approved "air conditioner" extension cord only (available at most hardware stores).
5. To avoid the possibility of personal injury, always disconnect the power supply to the unit, before installing and/or servicing.

### Important Safety Instructions

The power cord supplied with this air conditioner contains a current leakage detection device designed to reduce the risk of fire. Please refer to the section "Power Supply Cord" for details. In the event the power supply cord is damaged, it cannot be repaired it must be replaced with a new cord from the Product Manufacturer.

- Under no circumstances should this device be used to turn the air conditioner on or off.
- The 'RESET' button must always be pushed in (engaged) for correct operation.
- The power supply cord must be replaced if it fails to reset when the 'TEST' button is pushed in.
- If the power supply cord is damaged, it cannot be repaired. It must be replaced with a new cord obtained from the Product Manufacturer.

## Power Supply Cord

The power cord supplied with this air conditioner contains a device that senses damage to the power cord. To test if your power supply cord is working properly, you must do the following;

1. Connect the power supply cord to an electrical outlet.
2. The power supply cord is inclusive of two buttons located on the head of the plug. One button is marked 'TEST', the other button is marked 'RESET'. Press the 'TEST' button, you will hear a click as the 'RESET' button pops out.
3. Press the 'RESET' button, you will hear a click as the button engages.
4. The power supply cord is now energized and supplying electricity to the air conditioner. (On some products this is also indicated by a light on the plug head).

**Table 1**

### Suggested Individual Branch Circuit

Nameplate Amps	AWG Wire Size*
4.6	14

AWG- American Wire Gage

\* Based on copper wire at 60°C temperature rating.

**Table 2**

### Receptacle and Fuse Types

Rated Volts	125
Amps	15

Wall Outlet

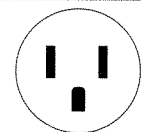

Fuse Size	15
-----------	----

Time Delay Fuse (or circuit breaker)	Plug Type
---	-----------



### CAUTION



Do not leave this unit unattended in a space where people or animals who cannot react to a failed unit are located. A failed unit can cause extreme overheating or death in such an enclosed, unattended space.

## Energy-Saving Tips

Your Diplomat appliance is designed to be highly efficient in energy savings. Follow these recommendations for greater efficiency:

- 1) Select a thermostat setting that suits your comfort needs and leave at that chosen setting.
- 2) The air filter is very efficient in removing airborne particles. Keep the air filter clean at all times.
- 3) Use drapes, curtains or shades to keep direct sunlight from penetrating and heating room, but do not allow drapes or curtains to obstruct the air flow around the unit.
- 4) Start your air conditioner before the outdoor air becomes hot and uncomfortable. This avoids an initial period of discomfort while the unit is cooling off the room. Use of the automatic start/stop programmable TIMER feature can be a major asset in this regard if utilized to the fullest extent.
- 5) When outdoor temperatures are cool enough, turn the air conditioner off and use the FAN MODE on HIGH, MEDIUM or LOW. This circulates indoor air, providing some cooling comfort and utilizes less electricity.

## Accessories

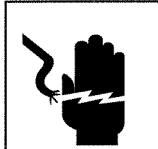

### Electric Shock Hazard

To avoid the possibility of personal injury, disconnect power to the unit before installing or servicing.



### CAUTION



To avoid installation/operation difficulties, read these instructions thoroughly.

### Installation Accessories Fig. 1

Description	Quantity
Flexible exhaust hose, collar & adapter.....	1/set from 19 1/2"(50cm) up to 59"(190cm)
Adjustable window door slider kit .....	3/set from 26 5/8"(67.5cm) up to 80"(203cm).

Direct Drain Adapter (not shown)..... 1 pc.

• The garden hose for elongated direct drain applications is not included with this unit.

NOTE: The exhaust window kit must be installed at all times when the unit is operating under the AIR CONDITIONING mode.



### IMPORTANT



There should be at least 11.8" (30 cm) clearance between the unit and any other objects or building structure and should be installed on a level surface. The unit does not have to be vented outside during Dehumidifer or Fan Only mode operation.

Fig. 1 Installation Accessories

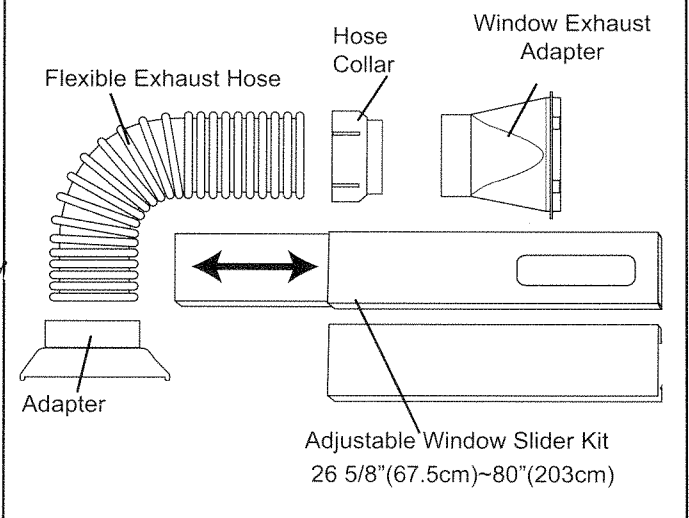

## Direct Drain Instructions

1. Remove the internal water tank; gently lift then pull outward as shown in Figure 2.

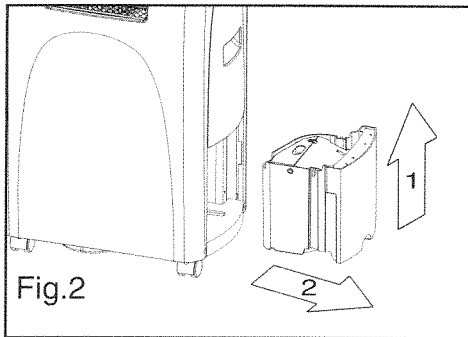

2. Locate the direct drain hose Figure 3 (a), and proceed to remove the black plug located at the end of the hose Figure 3 (b).

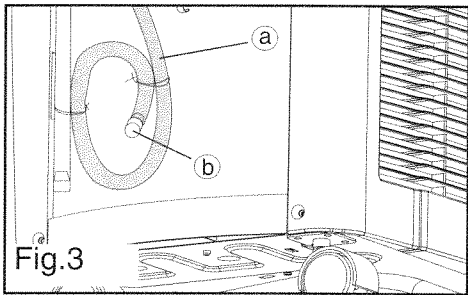

3. Route the end of the hose under the side of the water tank, then through the hole provided on the face of the tank and place the water tank back into the cabinet (As shown in Figure 4). *If required*, attach the included drain hose adapter (Fig 4) to the end of the drain tube and attach a section of garden hose (not included) to suit your continuous drain option requirements.

*Important:* Ensure that the drain hose section does not interfere with the correct positioning of the water tank inside the cabinet.

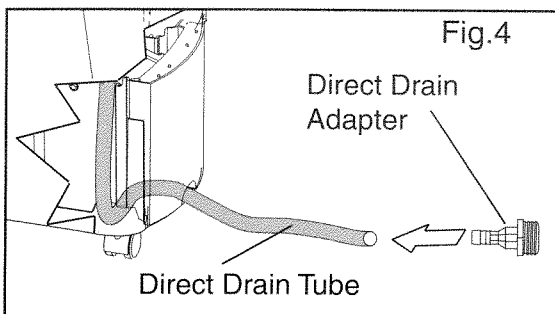

**Please Note:** Remember to reverse the above direct drain instructions when relocating the unit to a location where continuous drain is not possible. Failure to replace and recap the direct drain hose may result in flooding of the immediate area.



**CAUTION**



Always empty the external water tank before attempting to move or re-locate the unit to another location.

### Water Tank Safety Feature

This unit is equipped with a fail-safe switch mechanism which prevents the unit from condensing water in the event the internal water tank is accidentally displaced and/or is full. If this situation occurs, the (RED) **WATER FULL** indicator light will illuminate. This condition will remain steady until the external water tank is emptied.

**NOTE:** No cooling will occur until the internal tank is emptied and/or re-positioned. It may take several minutes before the compressor resumes normal operation.



**CAUTION**



During air conditioning and dehumidifier mode, if the compressor cycle is interrupted (water full condition, unplugged, power failure, etc.) and reinstated immediately thereafter, (within 3-5 minutes) a "compressor protection circuit" is automatically activated. The compressor cannot operate during "compressor protection" mode. (this is normal) It may take 3-5 minutes before the "protection circuit" self-deactivates.

**DO NOT ATTEMPT TO START THE UNIT (COMPRESSOR) DURING THIS PERIOD.**

## Window Kit Installation

(Air Conditioning Mode ONLY)

Your window kit has been designed to fit most standard "vertical" / "horizontal" windows up to a maximum height of 80" (203cm) For vertical window applications, multi lock positions are provided on the edge of each slider section to secure each sliding section together.

- 1) Select a suitable location, making sure you have access to an electrical outlet.
- 2) Install the flexible hose to the rear side of the unit. Insert the hose collar on top of the exhaust opening and twist to lock into position.
- 3) Install the adjustable Window Slider Kit as required. Fig's. 5, 6.
- 4) Install the opposite end of the flexible exhaust hose into the window exhaust adapter.
- 5) Install the window exhaust adapter into the opening in the slider section, making sure the window slider sections are secure.
- 6) Plug the unit into a 115 V / 60 Hz grounded electrical outlet.

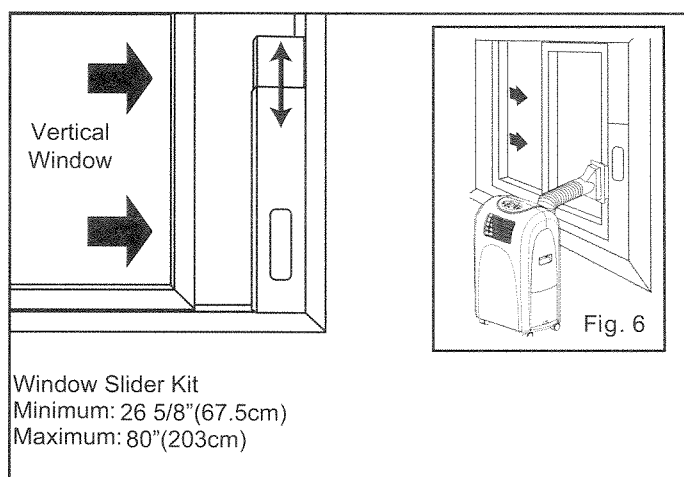
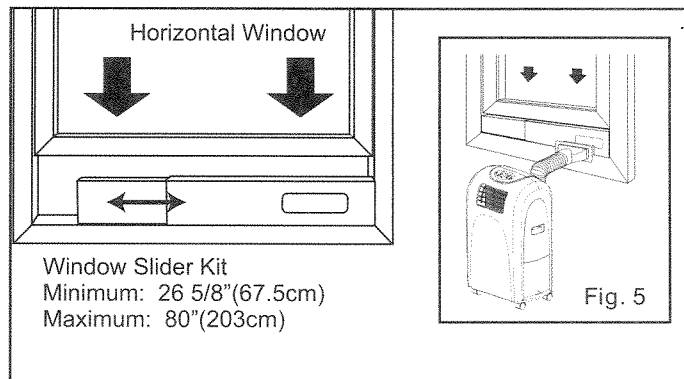

# Features of the Control Panel

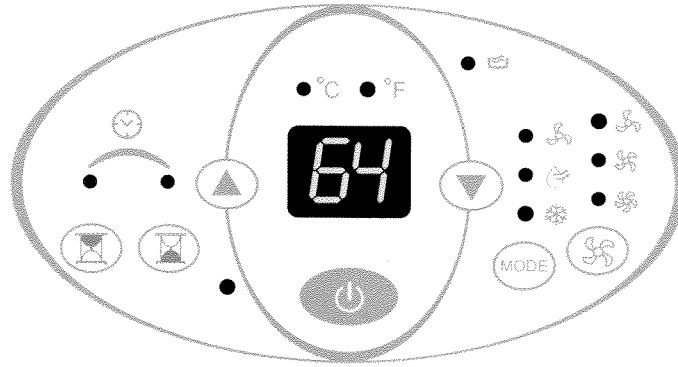

## KEY PAD FUNCTIONS



**POWER SWITCH:** Turns unit On / Off.



**MODE :** Allows you to scroll through and select the desired operating mode.



**FAN :** Select from three different fan settings; *High Medium and Low.*

### AUTO-TIMER Adjust :



**TIMER-ON:** Used to initiate the AUTO-ON (start) timer and adjust Timer On settings *forward(0.5/1hour)*



**TIMER-OFF:** Used to initiate the AUTO-OFF (stop) timer and adjust Timer Off settings *forward(0.5/1hour)*

### TEMPERATURE Adjust:





Continually depress to adjust temperature settings *forward* (1°C /2°F increments).



Continually depress to adjust temperature settings *backward* (1°C /2°F increments).

**Note:** This appliance allows you to select the temperature scale to be displayed in either the "Celsius" or Fahrenheit" according to your preference.

To change temperature scale displayed on the control panel display, press and hold  and  arrow buttons simultaneously to alternate between the "Celsius" & "Fahrenheit" scale.

## STATUS DISPLAY



**TEMPERATURE DISPLAY:** Displays current ambient room (fan mode only) or set temperature in Celsius or Fahrenheit scale.



**Celsius:** Signifies the temperature is currently displayed in Celsius.



**Fahrenheit:** Signifies the temperature is currently displayed in Fahrenheit.



**Water Full:** Illuminates to indicate that the inter water tank is full and will have to be emptied.

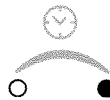

**AUTO-ON:** Signifies the auto-on timer setting has been initiated.



**AUTO-OFF:** Signifies the auto-off timer setting has been initiated.

## MODE INDICATOR LIGHTS



**Cool Mode:** Illuminates while the unit is operating in air conditioning mode.



**Dehumidifier (Dry) Mode:** Illuminates while the unit is operating in dehumidification mode.



**Fan Only Mode:** Illuminates while unit is operating in 'Fan Only' mode.

## FAN SPEED INDICATOR LIGHTS



**High Fan**



**Medium Fan**













**Low Fan**



## Air Conditioning Operating Instructions:

**IMPORTANT:** The exhaust hose must be properly vented (outdoors) during air conditioning mode.

- 1) Press the  POWER SWITCH key *Fig A* to switch on the unit, and the *previous set temperature* will be shown in the temperature display area of the control panel.
  - 2) Press the MODE key *Fig B*. until the COOL indicator light illuminates on the control panel *Fig C*. Each depression of the MODE key will advance to a different mode setting (Cool  - Dehumidifier  - Fan ).
  - 3) Press the appropriate increase  or decrease  buttons *Fig D* to select a suitable operating temperature setting. Temperature settings are adjustable between 17°C (62.6°F) ~ 30°C (86°F ).
  - 4) Press the  FAN key *Fig E* to select the desired fan speed setting (High  -Med  -Low ). Your selection will appear on the control panel (each depression of the fan key will advance to a different setting).
- Cooling stops automatically when the set temperature is achieved. Cooling resumes when the room temperature rises above the “set” temperature level.

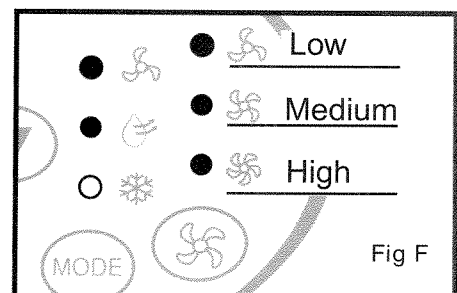
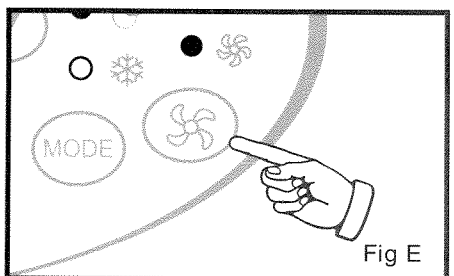
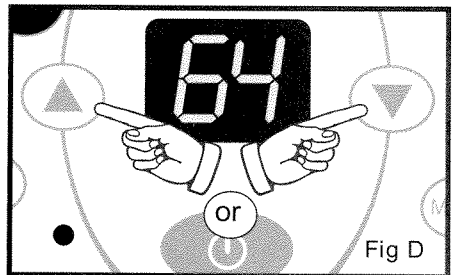
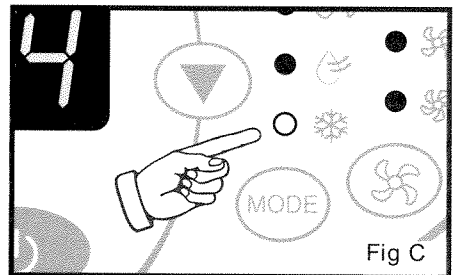
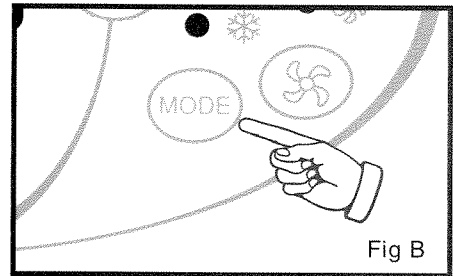
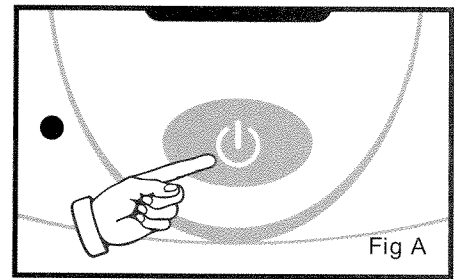



## Fan Operating Instructions:



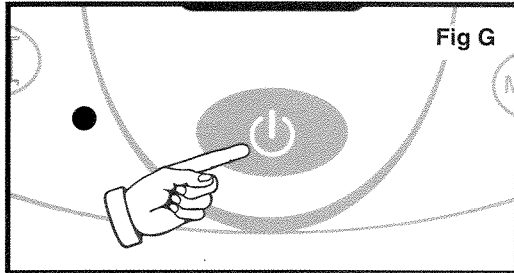

**Note:** During Fan mode, the exhaust hose does not have to be vented outdoors.

- 1) Press the  (on/off) key pad to switch on the unit. **Fig G**

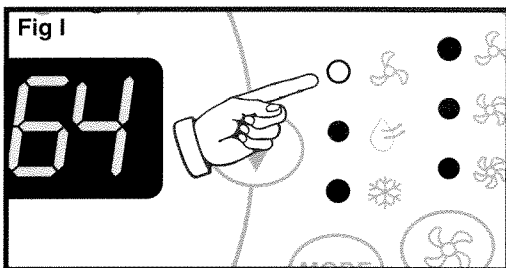
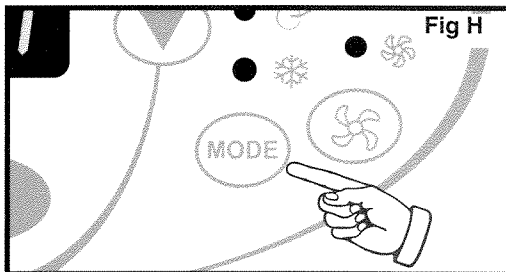

- 2) Press the **MODE** key **Fig H** until the **FAN** indicator illuminates on the control panel **Fig I**. Each depression of the **MODE** key will advance to a different mode setting (**Cool**  - **Dehumidifier**  - **Fan** ).





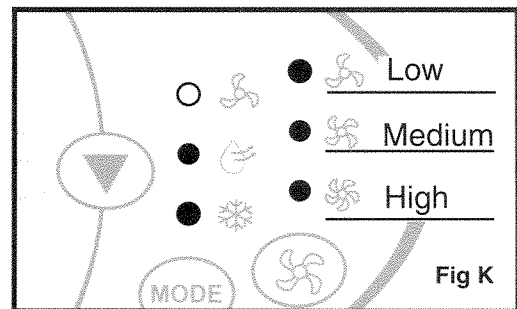
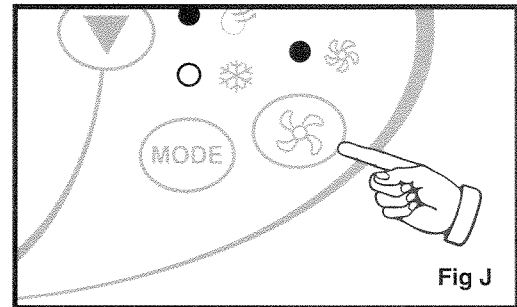

- 3) Press the  **FAN** key **Fig J** to select the desired **FAN SPEED** setting. Your selection will appear on the control panel. Each depression of the fan key will advance to a different fan speed (**High**  - **Med**  - **Low** ) as shown in **Fig K**.



## Dehumidifier Operating Instructions:

**Note:** During dehumidifier mode, the exhaust hose does not have to be vented outdoors.

- 1) Press the  (on/off) key pad to switch on the unit. **Fig G**
  - 2) Press the **MODE** key **Fig L** until the **DRY** indicator illuminates on the control panel **Fig M**. Each depression of the **MODE** key will advance to a different mode setting (**Cool**  - **Dehumidifier**  - **Fan** ).
- **Important:** There is no fan speed or temperature adjustment during dehumidifier mode. The fan speed is factory set for 'High' and the dehumidifier operates continuously (non-stop) regardless of ambient humidity level or set temperature.

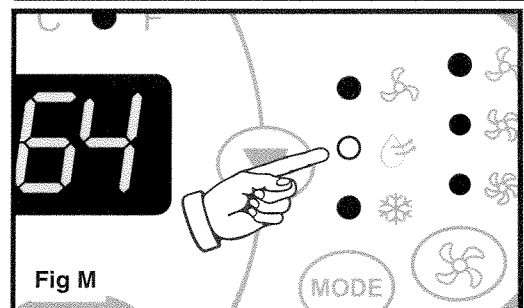
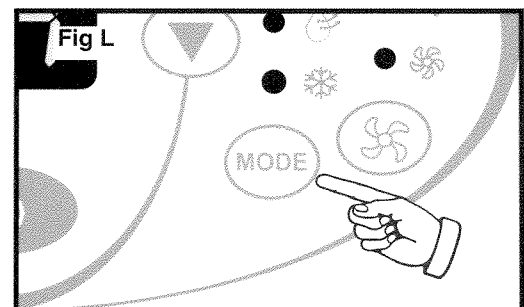

## Auto-Timer Instructions:

The AUTO-TIMER feature offers a unique selection of multiple choice, fully automatic on and/or off (start/stop) programs between 0.5 - 24 hrs under any one mode of your Home Comfort unit.



The programs are as follows:

- a) Auto -Off: Pre-select a time that will turn off the unit automatically (between 0.5 - 24 hrs.).
- b) Auto-On: Pre-select a time that will turn on the unit automatically (between 0.5 - 24 hrs.).
- c) Auto-On & Auto-Off: Pre-select a time that will turn the unit ON / OFF (automatically) at specified times (between 0.5 - 24 hrs.).

Note: These functions must be performed daily, as the program is automatically canceled/erased after the program has ended .

### Setting the AUTO-OFF TIMER

Before setting the AUTO-OFF timer, the unit must be (operational) turned on.



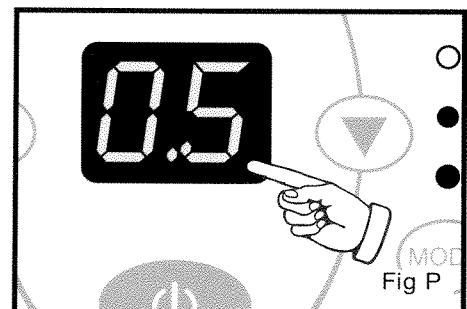
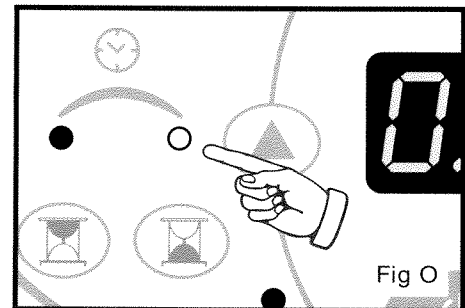
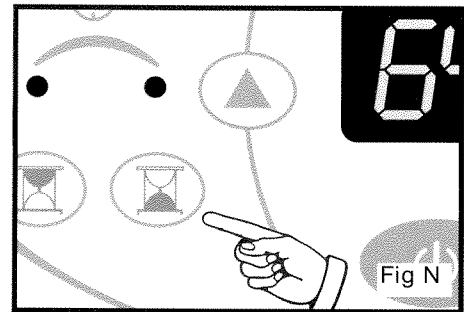

- 1) Press the  TIMER-OFF key pad (Fig N) to initiate the AUTO-OFF time sequence. The "AUTO-OFF" indicator (Fig O) will illuminate on the control panel and the timer digits (Fig P) will appear.
  - 2) Continually depress the  key to adjust Timer-Off settings *forward* by 0.5 hour increments (between 0.5 - 24 hrs).
  - 3) The timer setting will remain in the display window for three seconds before automatically reverting back to the temperature display.
  - 4) To view the timer setting at any time; press the  TIMER-OFF key pad again and the timer length you selected will be shown in the display window.
- The unit will stop automatically at the specified AUTO-OFF set time.
  - NOTE: To cancel or override the AUTO-OFF program, press the TIMER-OFF key to adjust Timer-Off settings *forward* to 0.0 hours.



## Setting the AUTO-ON TIMER

You must select all appropriate settings required to operate under the **AUTO TIMED** program before initiating the AUTO-ON program;

- Select the appropriate **MODE** under which you want the unit to operate (**Cool, Dehumidify or Fan**).
- Select the appropriate **FAN SPEED** setting, under which you want the unit to operate; **Hi, Medium or Low**. (excluding **Dehumidifying**, as this mode has one (1) pre-set fan speed setting only).
- To set the **AUTO-ON** timer, the unit must be turned “off” (non-operational).

- 1) Press the  (on/off) key pad to switch on the unit. **Fig S**
- 2) Select all appropriate operational settings (see listing above).
- 3) Press the  (on/off) key pad to switch the unit off. **Fig S**
- 4) Press the  **TIMER-ON** key pad (**Fig T**) to initiate the **AUTO-ON** time sequence. The “**AUTO-ON**” indicator light (**Fig U**) will illuminate on the control panel and the timer digits (**Fig V**) will appear in the display window.
- 5) Continually depress the  key to adjust Timer On settings *forward* by 0.5 hour increments (0.5 ~ 24 hours).
- 6) To view the timer setting at any time; press the  **TIMER-OFF** key pad again and the timer length you selected will be shown in the display window.
  - The unit will start automatically at the specified **AUTO-ON** set time.
  - To cancel or override the **AUTO-ON** program, simply turn on the unit anytime prior to when the **AUTO-ON** time is scheduled to operate.

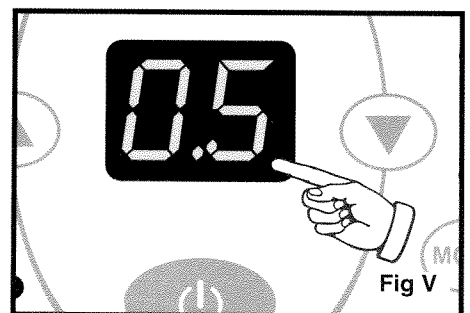
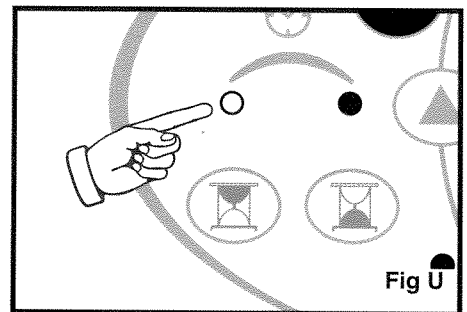
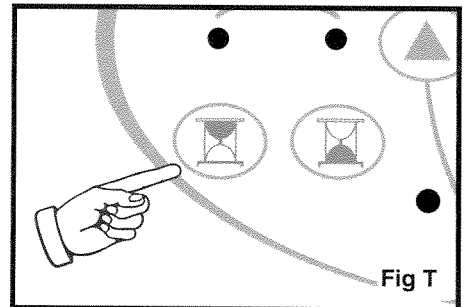
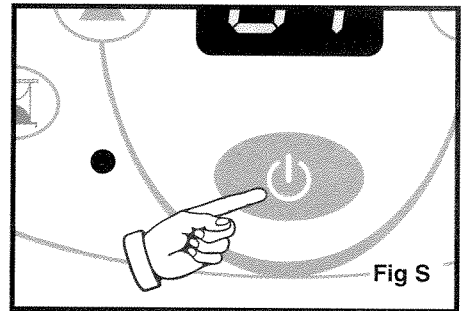

## Setting the AUTO-ON & OFF timer

Follow the above steps to set the auto-on timer then proceed to set the auto-off timer (see page 11). When setting the auto-on and auto off timer, the operation (running) time of the unit is the difference between the auto-on and auto-off set timer lengths. For example, to have the unit automatically power on two hours from now, then operate for one hour and power off; Set the auto-on timer length to 2 hours, and set the auto-off timer length to 3 hours, this sets the timer program for 1 hour of operation.

## Care and Maintenance



### CAUTION



Before cleaning or servicing this unit, it is recommended that the unit be disconnected from any electrical supply outlet.

- 1) Do Not use gasoline, benzene, thinner or any other chemicals to clean this unit, as these substances may cause damage to the finish and deformation of plastic parts.
- 2) Never attempt to clean the unit by pouring water directly over any of the surface areas, as this will cause deterioration of electrical components and wiring insulation.

### Storage and End of Season Care

If the unit will not be in use for a long period of time or is to be stored.

1. Remove the water tank and place a trip tray beneath sump drain tube Fig 7 (c).
2. Remove the black plug Fig 7 (d) to manually release the water from the internal reservoir.

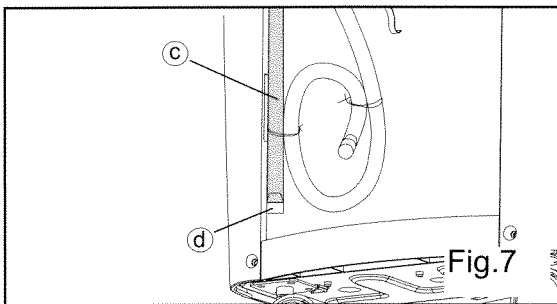

**CAUTION:** Failure to replace and recap the direct sump drain tube prior to using the unit may result in flooding of the immediate area.

### Removal and Cleaning of the Air Filter

If the air filter becomes clogged with dust/dirt, air flow is restricted and reduces cooling efficiency. The air filter should be cleaned every two (2) weeks. More frequent cleaning may be necessary depending upon indoor air quality. NOTE: The air filter is located at the (upper) rear side of the unit.

- 1) To remove the air filter: Pull the air filter cover upward in the direction of the arrow Fig 8 and remove the air filter.
- 2) Dust/Dirt clogged in the filter can be removed by vacuum cleaning the soiled areas.
- 4) The filter can also be washed in lukewarm soapy water while rubbing it lightly with a brush. A mild detergent (dishwashing soap) is recommended.
- 5) Rinse the filter well using clean water. Allow time to dry before reinstalling into the unit.
- 6) Replace the air filter and cover.
- 7) Replacement air filter information is available by the Customer Service Department at: 1-800-26-DANBY (1-800-263-2629)

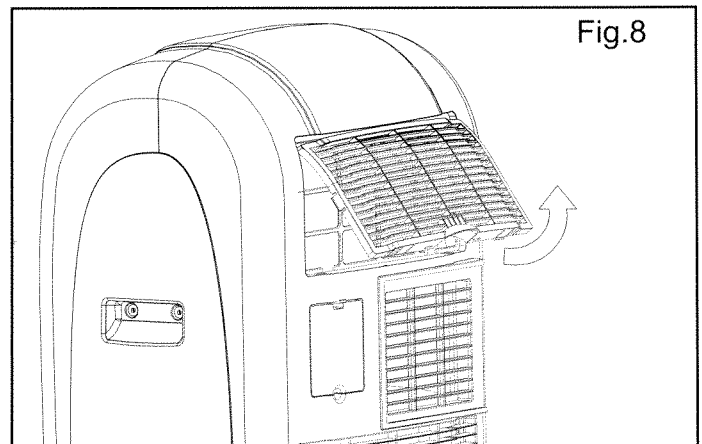

### CAUTION



Never operate the unit without the air filter in place as this may result in damage to the unit.

# DIPLOMAT®

## LIMITED AIR CONDITIONER WARRANTY

This quality product is warranted to be free from manufacturer's defects in material and workmanship, provided that the unit is used under the normal operating conditions intended by the manufacturer.

This warranty is available only to the person to whom the unit was originally sold by Danby or by an authorized distributor of Danby, and is non-transferable.

### TERMS OF WARRANTY

Plastic parts, are warranted for thirty (30) days only from purchase date, with no extensions provided.

<i>First 12 Months</i>	During the first twelve (12) months, any electrical parts of this product found to be defective, including any sealed system units, will be repaired or replaced, at warrantor's option, at no charge to the ORIGINAL purchaser.
<i>To obtain Service</i>	Danby reserves the right to limit the boundaries of "In Home Service" to the proximity of an Authorized Service Depot. Any appliance requiring service outside the limited boundaries of "In Home Service", it will be the consumer's responsibility to transport the appliance (at their own expense) to the original retailer (point of purchase) or a service depot for repair. Contact your dealer from whom your unit was purchased, or contact your nearest authorized Danby service depot, where service must be performed by a qualified service technician. If service is performed on the units by anyone other than an authorized service depot, or the unit is used for commercial application, all obligations of Danby under this warranty shall be at an end.

### EXCLUSIONS

Save as herein provided, Danby Products Limited (Canada) or Danby Products Inc. (U.S.A.), there are no other warranties, conditions, representations or guarantees, express or implied, made or intended by Danby Products Limited or its authorized distributors and all other warranties, conditions, representations or guarantees, including any warranties, conditions, representations or guarantees under any Sale of Goods Act or like legislation or statute is hereby expressly excluded. Save as herein provided, Danby Products Limited (Canada) or Danby Products Inc. (U.S.A.), shall not be responsible for any damages to persons or property, including the unit itself, howsoever caused or any consequential damages arising from the malfunction of the unit and by the purchase of the unit, the purchaser does hereby agree to indemnify and save harmless Danby Products Limited from any claim for damages to persons or property caused by the unit.

### GENERAL PROVISIONS

No warranty or insurance herein contained or set out shall apply when damage or repair is caused by any of the following:

- 1) Power Failure.
- 2) Damage in transit or when moving the appliance.
- 3) Improper power supply such as low voltage, defective house wiring or inadequate fuses.
- 4) Accident, alteration, abuse or misuse of the appliance such as inadequate air circulation in the room or abnormal operating conditions, (extremely high or low room temperature).
- 5) Use for commercial or industrial purposes.
- 6) Fire, water damage, theft, war, riot, hostility, acts of God such as hurricanes, floods etc.
- 7) Service calls resulting in customer education.

Proof of purchase date will be required for warranty claims; so, please retain bills of sale. In the event warranty service is required, present this document to our AUTHORIZED SERVICE DEPOT.

Warranty Service

Carry-In

Danby Products Limited  
PO Box 1778, 5070 Whitelaw RD, Guelph, Ontario, Canada N1H 6Z9  
Telephone: (519) 837-0920 FAX: (519) 837-0449

Danby Products Inc.  
PO Box 669, 101 Bentley Court, Findlay, Ohio, U.S.A. 45839-0669  
Telephone: (419) 425-8627 FAX: (419) 425-8629

12/06

# DIPLOMAT®

Model • Modèle

**DPAC5070**

For service, contact your nearest service depot or call:

**1-800-26-DANBY  
(1-800-263-2629)**

to recommend a depot in your area.

Pour obtenir le service, consultez votre centre de service le plus rapproché ou composez le :

**1-800-26-DANBY  
(1-800-263-2629)**

qui vous recommandera un centre régional.

## Portable Air Conditioner

The model number can be found on the serial plate located on the back panel of the unit.

All repair parts available for purchase or special order when you visit your nearest service depot. To request service and/or the location of the service depot nearest you, call the TOLL FREE NUMBER.

When requesting service or ordering parts, always provide the following information:

- Product Type
- Model Number
- Part Number
- Part Description

## Climatiseur Portatif

Le numéro de modèle se trouve sur la plaque d'information sur le panneau arrière de l'appareil.

Toutes les pièces de rechange ou commandes spéciales sont disponibles à votre centre de service régional autorisé. Pour obtenir le service et/ou la localité de votre centre de service régional, signalez le NUMÉRO D'APPEL SANS FRAIS.

Ayez les renseignements suivants à la portée de la main lors de la commande de pièce ou service :

- Type de produit
- Numéro de modèle
- Numéro de pièce
- Description de la pièce

## Free Manuals Download Website

<http://myh66.com>

<http://usermanuals.us>

<http://www.somanuals.com>

<http://www.4manuals.cc>

<http://www.manual-lib.com>

<http://www.404manual.com>

<http://www.luxmanual.com>

<http://aubethermostatmanual.com>

Golf course search by state

<http://golfingnear.com>

Email search by domain

<http://emailbydomain.com>

Auto manuals search

<http://auto.somanuals.com>

TV manuals search

<http://tv.somanuals.com>