

Instruction Manual

DDW1802W

Dishwashers

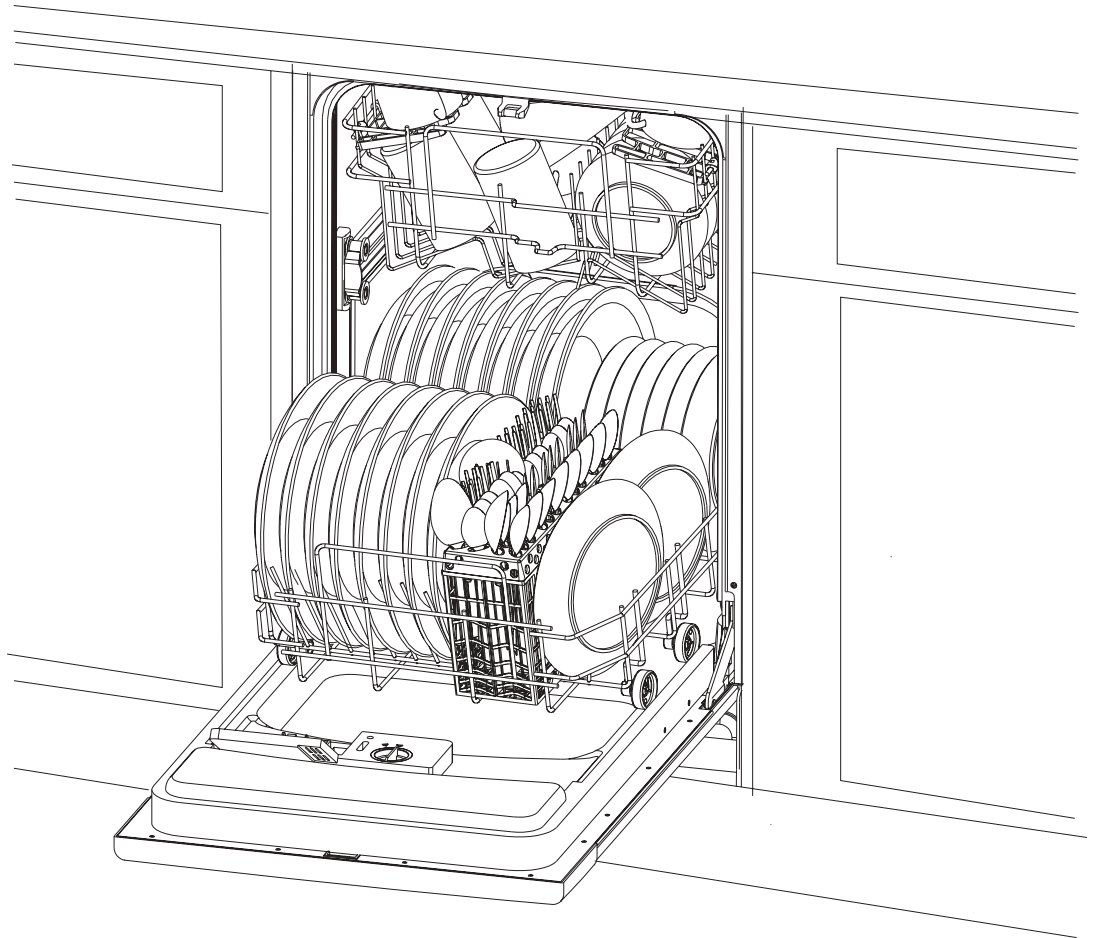

Write the model and serial numbers here:

Model # _____

Serial # _____

You can find them on the tub wall just inside the door or the lower part of the back.

SAVE THESE INSTRUCTIONS

Danby & You, A Service Partnership

Thank you for buying this product. As a home appliances producer, we are proud of our quality products and we are committed to providing dependable service. We are able to utilize our global resources in creating innovation that makes housework lighter and easier, and provide a truly comfortable home for you to relax and enjoy.



Read this Manual

This manual contains specific operating instructions, safety instructions and troubleshooting tips. Please take a moment to carefully read the contents of this manual thoroughly and familiarize yourself with all operational aspects of your new dishwasher. This information will help you to use and maintain the dishwasher properly. These instructions are not meant to cover every possible condition and/or situation that may occur. Common sense and caution must be practiced when installing, operating and maintaining any appliance.



Before Calling for Service

Before calling for service, review the section on troubleshooting tips. It may save you time and costly expense. This list includes common problems that are not the result of defective workmanship or materials in this appliance. NOTE: Never attempt to repair any equipment you are not properly qualified (trained) to service.



If You Need Service

If you can not solve the problems by yourself after reading the section on Troubleshooting Tips, please contact our professional Customer Service Centre at 1-800-26-DANBY (1-800-263-2629). Danby's Customer Service Centre is open Monday - Thursday from 8:30 a.m. to 5:00 p.m. and on Friday from 8:30 a.m. to 4:00 p.m. EST.

Safety Information 1

Operating Instructions

Control Panel	2
Dishwasher Features	2
Wash Cycle Table	3
Water Softener	4
Detergent Dispenser	5
Rinse Aid Dispenser	5
Loading the Dishwasher Rack	6,7
Turning On the Appliance	7
Filtering System	8
Caring for the Dishwasher	8,9

Troubleshooting Tips

Before calling for service	10,11
----------------------------------	-------

IMPORTANT SAFETY INFORMATION

READ ALL INSTRUCTIONS BEFORE USING

WARNING!

When using your dishwasher, follow the basic precautions below.

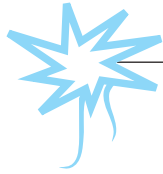

WARNING! HYDROGEN GAS IS EXPLOSIVE

Under certain conditions, hydrogen gas may be produced in a hot-water system that has not been used for two weeks or more. HYDROGEN GAS IS EXPLOSIVE.

If the hot-water system has not been used for such a period, before using the dishwasher turn on all hot-water faucets and let the water flow from each for several minutes. This will release any accumulated hydrogen gas. As the gas is flammable, do not smoke or use an open flame during this time.



GROUNDING INSTRUCTIONS

Power Cord Models

This appliance must be grounded. In the event of a malfunction or breakdown, grounding will reduce the risk of electric shock by providing a path of least resistance for electric current. This appliance is equipped with a cord having an equipment-grounding conductor and a grounding plug. The plug must be plugged into an appropriate outlet that is installed in an accordance with all local codes and ordinances.

WARNING!

Improper connection of the equipment-grounding conductor can result in a risk of electric shock. Check with a qualified electrician or service representative if you are in doubt whether the appliance is properly grounded. Do you modify the plug provided with the appliance? If it will not fit the outlet, have a proper outlet installed by a qualified electrician.

Cable Direct

This appliance must be connected to a grounded metal, permanent wiring system, or an equipment-grounding conductor must be run with the circuit conductors and connected to the equipment-grounding terminal or lead on the appliance.



WARNING! PROPER USE

- n Do not abuse, sit or stand on the door or dishrack of the dishwasher.
- n Do not touch the heating element during or immediately after use.
- n Do not wash plastic items unless they are marked dishwasher safe. For unmarked plastic items, check the manufacturer's recommendations.
- n Use only detergent and rinse additives designed for an automatic dishwasher. Never use soap, laundry detergent, or hand washing detergent in your dishwasher. Keep these products out of the reach of children.
- n Keep children away from the detergent and rinse aid, and from the open door of the dishwasher, as there could still be some detergent left inside.
- n The door should not be left in the open position as this could present a tripping hazard.
- n During installation, the power supply must not be excessively or dangerously bent or flattened.
- n To reduce the risk of injury, do not allow children to play in or on a dishwasher.
- n Do not operate your dishwasher unless all enclosure panels are properly in place. Open the door very carefully if the dishwasher is operating, there is a risk of water spraying out.
- n Do not place any heavy objects on the door when it is open. The appliance could tip forward.
- n When loading items to be washed:
 - 1) Load sharp items so that they are not likely to damage the door seal
 - 2) Load sharp knives with the handles up to reduce the risk of cuts.
- n When using your dishwasher, you should prevent plastic items from coming in contact with the heating element.
- n If the supply cord is damaged, it must be replaced by the manufacturer, its service agent or a qualified technician to avoid a hazard.
- n Please dispose of packing materials properly.
- n Use the dishwasher only for its intended function.
- n Remove the door to the washing compartment when removing an old dishwasher from service or discarding it.
- n Do not tamper with the controls.

READ AND FOLLOW THIS SAFETY INFORMATION CAREFULLY

SAVE THESE INSTRUCTIONS

CONTROL PANEL

Models: DDW1802W

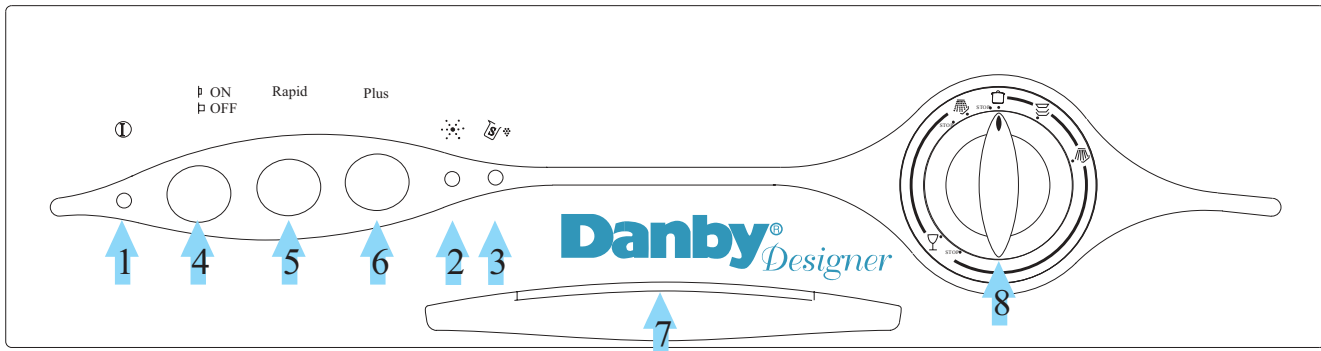





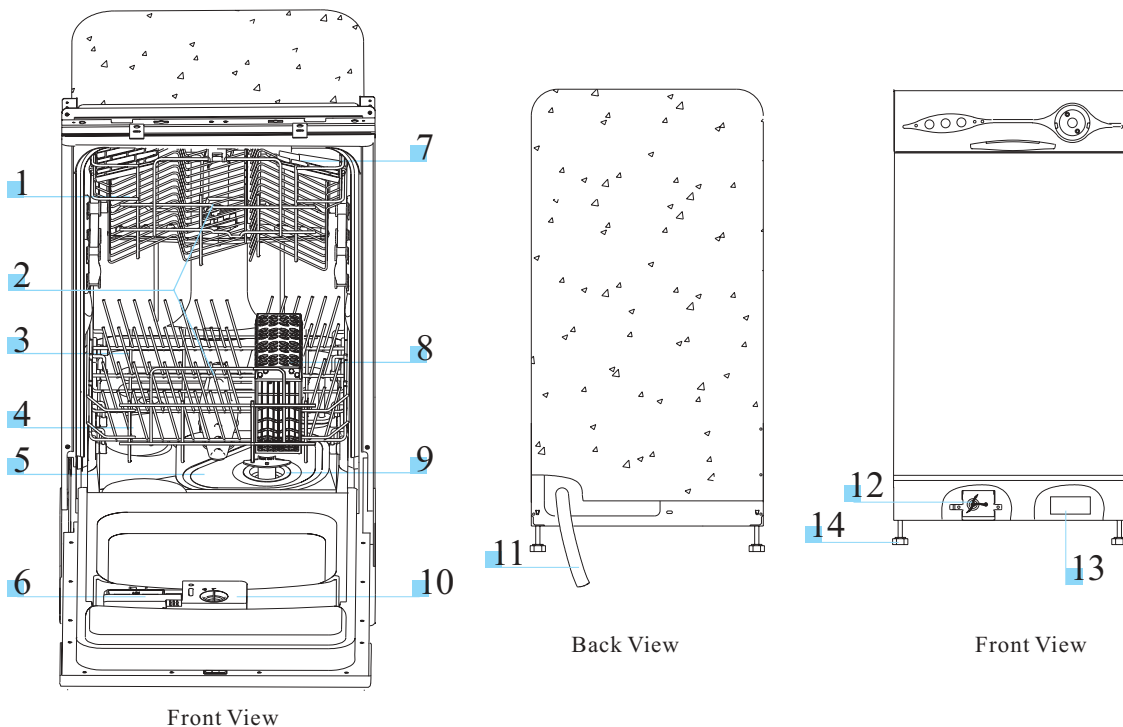

- 1** Power ON Light: Illuminates when the ON/OFF Button is pressed down.
- 2** Rinse Aid Warning Light: Illuminates when the dispenser needs to be refilled.
- 3** Salt Warning Light: Illuminates when the water softener needs to be refilled.
- 4** ON/OFF Button: Turns on/off the power supply.
- 5** Rapid Button: Only used with cycle "▽".
- 6** Plus Button: Only used with cycle "□".
- 7** Door Handle: Pull to open the door.
- 8** Washing Program Selector: Turn the dial clockwise to select the desired wash cycle.

DISHWASHER FEATURES



- 1** Upper Rack
- 5** Main Filter
- 9** Coarse Filter
- 13** Junction Box
- 2** Spray Arms
- 6** Detergent Dispenser
- 10** Rinse Aid Dispenser
- 14** Leveling Leg
- 3** Lower Rack
- 7** Cup Shelf
- 11** Drain Hose
- 4** Water Softener
- 8** Silverware Basket
- 12** Inlet Valve

WASH CYCLE TABLE(DDW1802W)

Program	Cycle	Plus Button	Rapid Button	Cycle Selection Information	Description of Cycle	Detergent pre/main	Rinse Aid
Normal	 Normal Wash (IEC-EN 50242)			For normally soiled loads, such as pots, plates, glasses and lightly soiled pans. Standard Daily Cycle.	Pre-rinse Wash (60°) Rinse Rinse (72°) Drying	4/20 gr.	★
Intensive	 Normal Wash	★		For heavily soiled loads, such as pots, pans, casserole dishes and dishes with dried food.	Pre-rinse(50°) Wash (60°) Rinse Rinse Rinse (72°) Drying	4/20 gr.	★
Economic	 Light Wash			For lightly soiled loads, such as plates, glasses, bowls and lightly soiled pans.	Wash (60°) Rinse Rinse (72°) Drying	20 gr.	★
Rinse	 Rinse			For dishes that need to be rinsed and dried only.	Rinse Rinse (68°) Drying		★
Glass	 Glassware			For lightly soiled loads, such as glasses, crystal and fine china.	Rinse (45°) Rinse (72°) Drying	15 gr.	
Rapid	 Glassware		★	A shorter wash for lightly soiled loads that do not need drying.	Rinse (45°) Rinse (50°) Drying	15 gr.	
Soak	 Soak			Use to rinse the dishes that you plan to wash later that day.	Pre-rinse		

WASH CYCLE ADJUSTMENT BUTTONS

Plus Button

This button (see "Control panel") is used with the normal cycle where pots and pans have dry, caked-on food.

This is not recommended for delicate items as the high temperature could make their surfaces opaque or their decorative colors lighten after repeated washings.

Rapid Button

This button (see "Control panel") when used with wash cycle 4 (glassware) makes it possible to run the wash cycle at a lower temperature (50°C) and eliminates the drying phase.

WATER SOFTENER

There are two ways to reduce the water hardness: one way is by using water softener, the other is by using detergent.

The hardness of the water varies from place to place. If hard water is used in the dishwasher, deposits will form on the dishes and utensils.

The appliance is equipped with a special softener that uses salt specifically designed to eliminate lime and minerals from the water.

Loading the Salt into the Softener

Always use salt intended for use with dishwashers.

The salt container is located beneath the lower rack and should be filled as follows:

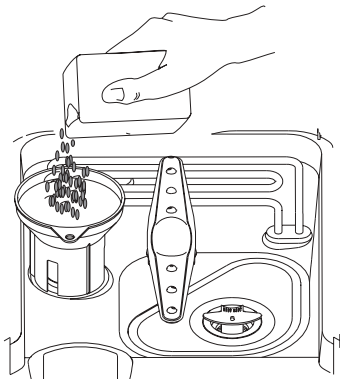

- 1 Remove the lower basket and unscrew and remove the cap from the salt container.
- 2 If you are filling the container for the first time, fill 2/3 of its volume with water.
- 3 Place the end of the salt filter (supplied) into the hole and introduce about 2kg of salt. It is normal for a small amount of water to come out of the salt container.
- 4 Carefully screw on the cap.

NOTE: 1. The salt container must be refilled when the salt warning light comes on. Though the salt container is filled, the indicator light may not black out before the salt fully dissolves.
2. If there are spills of salt, a soak program could be run to clean the spills.

Adjusting Salt Consumption

The dishwasher is designed to allow for adjusting the amount of salt consumed based on the hardness of the water used. This is intended to optimize and customize the level of salt consumption.

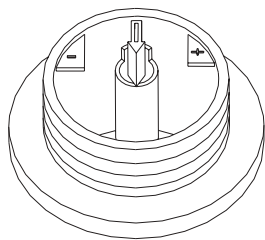

- 1 Unscrew the cap from the salt container.
- 2 There is a ring on the container with an arrow on it (see Figure to the side). If necessary, rotate the ring in the counterclockwise direction from the "-" setting toward the "+" sign, based on the hardness of the water being used. It is recommended that adjustments should be made in accordance with the following chart:

WATER HARDNESS			Selector Position	Salt consumption (gram/cycle)	Auto nomy (cycles/2kgs)
Clarke Degrees	°dH	mmol/l			
0~14	0~10	0~1.7	-	0	/
14~36	18~44	1.8~4.4	/	20	60
36~71	45~89	4.5~8.9	MED	40	40
71	89	8.9	+	60	25

Contact your local water board for information on the hardness of your water supply.

DETERGENT DISPENSER

The dispenser must be refilled before the start of each wash cycle according to the instructions provided in the " Wash Cycle Table". Our dishwashers use less detergent and rinse aid than conventional dishwashers. Generally, only one tablespoon of detergent is needed for a normal wash load. More heavily soiled items need more detergent. Always add the detergent just before starting dishwasher, otherwise it could get damp and will not dissolve properly.

Amount of Detergent to Use

IF THE WATER ISN'T TOO HARD, YOU MAY ALSO PREVENT THE FORMATION OF DEPOSITS BY ADDING DETERGENT. The amount of detergent needed can vary due to differences in water hardness. To determine the water hardness in your area, contact your local water utility or area water softening company. The harder the water, the more detergent you may need. Remember, you should adjust the amount of detergent you use little by little until you find the correct amount.

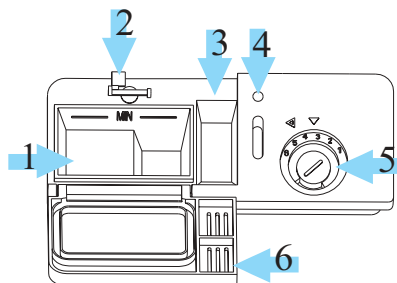

- 1 Main Wash Detergent
- 2 Dispenser Lid lever
- 3 Prewash Detergent Compartment
- 4 Rinse Aid Level Indicator
- 5 Rinse Aid Compartment
- 6 Detergent Compartment Lid

▲ WARNING!

Dishwasher detergent is corrosive! Take care to keep it out of the reach of children.

RINSE AID DISPENSER

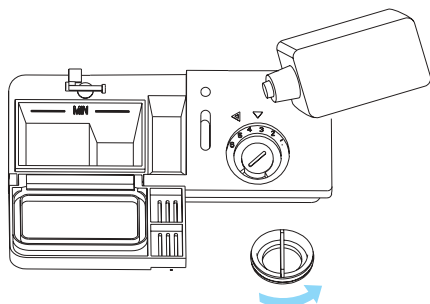

- To open the dispenser, turn the cap to the "open" (left) arrow and lift it out.
- Pour the rinse aid into the dispenser, being careful not to overfill.
- Replace the cap by inserting it aligned with "open" arrow and turning it to the "close" (right) arrow.

Removing Hard Water Spots From Dishes

To remove hard water spots, try the following:

- Run dishes through a normal wash program.
- Remove all metal dishware, such as cutlery, pans, etc., from the dishwasher.
- Do not add detergent.
- Pour two cups of vinegar into a bowl and set the bowl face up on the lower rack of the dishwasher.
- Run the dishes through a normal wash program.

If this doesn't work, try the same process with 1 / 4 cup of citric acid crystals instead of vinegar.

Proper Use of Detergent

Use only detergent specifically made for use in dishwashers. Keep your detergent fresh and dry. Don't put powder detergent into the dispenser until you are ready to wash dishes.

The rinse aid is released during the final rinse to prevent water from forming droplets on your dishes that can leave spots and streaks. It also improves drying by allowing water to "sheet" off the dishes.

Our dishwashers are designed to use liquid rinse aids. The rinse aid dispenser is located inside the door next to the detergent dispenser. To fill the dispenser, open the cap and pour the rinse aid into the dispenser until the level indicator turns completely black. The dispenser holds about 100 ml of liquid rinse aid.

Be careful not to overfill the dispenser, because this could cause over sudsing. Wipe away any spills with a damp cloth. Don't forget to replace the cap before you close the dishwasher door.

If you have soft water, you may not need rinse aid as it may cause a white film to develop on your dishes.

Adjusting Rinse Aid Dispenser

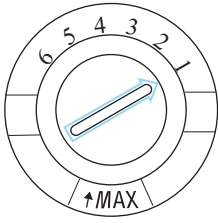

A measured amount of rinse aid is released during the final rinse. As with detergent, the amount of rinse aid needed for your dishes depends on the hardness of the water in your area. Too much rinse aid can result in lather or foaming and can cause cloudiness or streaks on your dishes. If the water in your area is very soft, you may not need rinse aid. If you do, you can dilute the rinse aid with an equal amount of water.

The rinse aid dispenser has six settings. Always start with the dispenser set on "1". If spots and poor drying are problems, increase the amount of rinse aid dispensed by removing the dispenser lid and rotating the dial to "2". If the dishes still are not drying properly or are spotted, adjust the dial to the next higher number until your dishes are spot-free. We suggest the setting of "4".

When to Refill the Rinse Aid Dispenser

If there is no rinse aid warning light or the control panel, you can judge the amount of rinse aid by the following means. The black dot on the rinse aid dispenser indicates the amount of rinse aid in the dispenser. As the rinse aid diminishes, the size of the black dot decreases. You should never let the rinse aid get below 1 / 4 full.

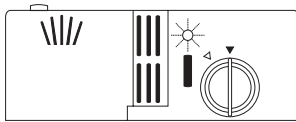

As the rinse aid diminishes, the size of the black dot on the rinse aid level indicator changes, as illustrated below.

- Full
- 3 / 4 full
- 1 / 2 full
- 1 / 4 full - Should refill to eliminate spotting
- Empty

Loading the Dishwasher Racks

For best performance, follow these loading guidelines. Features and appearance of racks and silverware baskets may vary from your model.

How to use the Upper Rack

The upper rack is designed to hold more delicate and lighter dishware such as glasses, coffee and tea cup and saucers, as well as plates, small bowls and lightly soiled shallow pans.

Position the dishes and cookware so that they do not get moved by the spray of water.

The upper rack can be adjusted for height by putting wheels of different height into the rails.

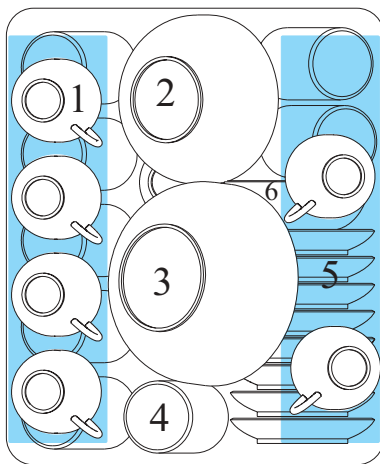

- 1 Cups
- 2 Small serving bowl
- 3 Large serving bowl
- 4 Glasses
- 5 Saucers
- 6 Dish
- 7 Plates

How to use the Lower Rack

We recommend that you place large items in the lower rack: pots, pans, lids, serving dishes and bowls, as shown below.

It is preferable to place serving dishes and lids on the side of the racks in order to avoid blocking the rotation of the top spray arm.

- Pots, serving bowls, etc, must always be placed top down.
- Deep pots should be slanted to allow water flow.
- The bottom rack features fold down tine rows so that larger or more pots and pans can be loaded.

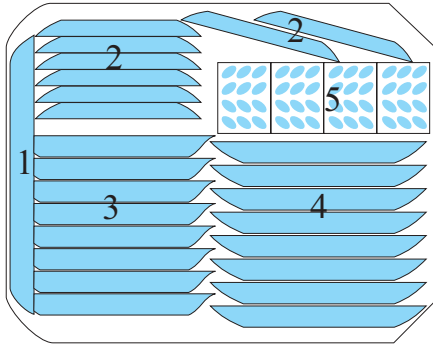

- 1 Oval platter
- 2 Dinner plates
- 3 Soup plates
- 4 Dessert dishes
- 5 Silverware basket

SILVERWARE BASKET

Silverware should be placed in the silverware basket with handles at the bottom: If the rack has side baskets, the spoon should be loaded individually in the appropriate slots. Long utensils should be placed in the horizontal position at the front of the upper rack.

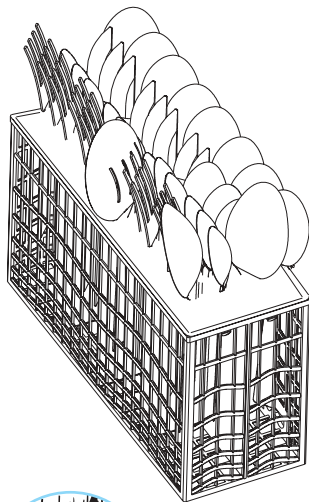

1	4	5	2
1	4	5	
1	4	5	2
1	4	5	2
1	4	5	2
7	4	5	2
8	3	5	
1	3	3	2
1	3	3	2
1	3	3	
6	3	6	2

- 1 Forks
- 2 Soup spoons
- 3 Dessert spoons
- 4 Teaspoons
- 5 Knife
- 6 Serving spoon
- 7 Gravy ladle
- 8 Serving fork



▲ WARNING!

Do not let any item extend through the bottom of the basket.

TURNING ON THE APPLIANCE

Starting a wash cycle. . .

- 1 Make sure that the plug for the appliance is inserted into the wall socket.
- 2 Make sure that the water supply is turned on to full pressure.
- 3 Load the dishwasher (see the section entitled, "Loading the Dishwasher").
- 4 Pour in the detergent (see the section entitled, "Salt, Detergent and Rinse Aid").
- 5 Turn the dial located on the right of the control panel in the clockwise direction until the number or the symbol for the cycle setting is aligned with the reference mark (see the section entitled, "Wash Cycle Table").
- 6 Press the ON/OFF button, and the ON/OFF light will turn on. At this point, the wash cycle will begin.

Cancelling or modifying a wash cycle setting. . .

A cycle that is underway can only be modified if it has only been running for a short time. Otherwise, the detergent may have already been released, and the appliance may have already drained the wash water. If this is the case, the detergent dispenser must be refilled (see the paragraph entitled " Loading the Detergent ").

Press the ON/OFF button, and the ON light will turn off. Rotate the dial in the clockwise direction to the desired cycle setting (see the section entitled " Starting a wash cycle. . . "). Then, turn the dishwasher back on using the ON/OFF button.

At the End of the Wash Cycle

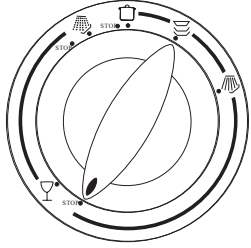

When the dial stops turning and is aligned with the STOP mark (see figure), the cycle has finished. Turn off the appliance using the ON/OFF button, shut off the water supply and open the door of the dishwasher. Wait a few minutes before unloading the dishwasher to avoid handling the dishes and utensils while they are still hot and more susceptible to breakage.

Forget to Add a Dish?

A forgotten dish can be added any time before the detergent cup opens.

- 1 Pull the door handle.
- 2 Do not open the door until the water spray action stops. Steam may rise out of the dishwasher.
- 3 Add forgotten dishes.
- 4 Push the door to close. When the door is properly closed, a click will sound.

FILTERING SYSTEM

For your convenience, we have placed the drain pump and filtering system within easy reach inside the tub. There are three components of the filtering system: the main filter, the coarse filter, and the fine filter.

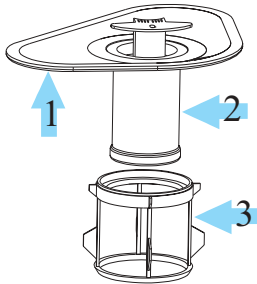

- 1 Main filter
Food and soil particles trapped by this filter are pulverized by a special jet on the lower spray arm and washed down the drain.
- 2 Coarse filter
Larger items, such as pieces of bone or glass, that could clog the drain are trapped in the coarse filter. To remove an item caught in this filter, gently squeeze the tabs on top of this filter and lift it out.
- 3 Fine filter
This filter holds soil and food residue in the sump area and prevents it from being redeposited on the dishes during a cycle.

CARING FOR THE DISHWASHER

To clean the control panel use a lightly dampened cloth then dry thoroughly. To clean the exterior use a good appliance polish wax.

Never use sharp objects, scouring pads or harsh cleaners on any part of the dishwasher.

Protect Against Freezing

If your dishwasher is left in an unheated place during the winter, ask a service technician to:

- 1 Cut off electrical power to the dishwasher and remove fuses or trip circuit breaker.
- 2 Turn off the water supply and disconnect the water inlet pipe from the water valve.
- 3 Drain the water from the inlet pipe and water valve. (Use a pan to catch the water.)
- 4 Reconnect the water inlet pipe to the water valve.
- 5 Remove the plastic sump cover in the tub the bottom and use a sponge to soak up the water in rubber boot.

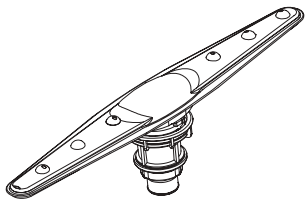

Cleaning the Spray Arms

It is necessary to clean the spray arms regularly as hard water chemicals will clog the spray arm jets and bearings. To remove the spray arm, screw off the nut to take out the washer on top of the spray arm and remove the arm. Wash the arms in soapy, warm water and use a soft brush to clean the jets. Replace after rinsing them thoroughly.

Cleaning the Filters

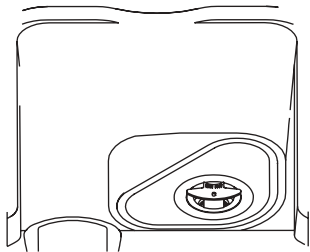

Filter assembly

For best performance and results, the filter assembly must be cleaned.

The filter efficiently removes food particles from the wash water, allowing it to be recirculated during the cycle. For this reason, it is a good idea to remove the larger food particles trapped in the filter after each wash cycle by rinsing the semicircular filter and cup under running water. To remove the filter assembly, pull on the cup handle in the upward direction. The entire filter assembly should be cleaned at least once a month.

To clean the coarse filter and the fine filter, use a cleaning brush. Then, reassemble the filter parts as shown in the figure at left and reinsert the entire assembly in the dishwasher, positioning in its seat and pressing downward.

The dishwasher must never be used without the filters. Improper replacement of the filter may reduce the performance level of the appliance and may damage dishes and utensils.

▲ WARNING!

Never run the dishwasher without the filters in place.

Cleaning the Door

To clean the edge around the door, you should use only a soft warm, damp rag. To prevent penetration of water into the door lock and electrical components, do not use a spray cleaner of any kind.

Also, never use abrasive cleaners or scouring pads on the outer surfaces because they will scratch the finish. Some papers towels can also scratch or leave marks on the surface.

Cleaning the Drain Pump

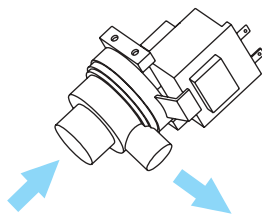

Something will occasionally move into the filters and the drain pump. If this occurs, the drain pumps employed in our dishwashers are designed to automatically reverse, ejecting the item back into the sump area or down the drain. If you have to remove an obstacle from the drain pump, before you remove the filters, you should turn off the power; Then remove the small black insert from the sump area. (You might want to remove any standing water first). Scoop out the item that is probably in the sump area and causing the obstruction. Remember to replace the black insert before replacing the filters.

How to Keep Your Dishwasher Running Properly

■ After Every Wash

After every wash, turn off the water supply to the appliance and leave the door slightly ajar so that moisture and odors are not trapped inside.

■ No Solvents or Abrasive Cleaning Products

To clean the exterior and rubber parts of the dishwasher, do not use solvents or abrasive cleaning products. Use only a cloth and warm, soapy water. To remove spots or stains from the surface of the interior, use a cloth dampened with warm water and a little white vinegar, or a cleaning product made specifically for dishwashers.

■ When You Go on Holiday

When you go on holiday, it is recommended that you run a wash cycle with the dishwasher empty and then remove the plug from the socket, turn off the water supply and leave the door of the appliance slightly ajar. This will help the seals last longer and prevent odors from forming in the appliance.

■ Seals

One of the factors that cause odors to form in the dishwasher is food that remains trapped in the seals. Periodic cleaning with a damp sponge will prevent this from occurring.

BEFORE CALLING FOR SERVICE . . .

Troubleshooting Tips

Review the chart on the following pages before calling for service.



<i>Problem</i>	<i>Possible Causes</i>	<i>What To Do</i>
<i>Dishwasher doesn't run</i>	Fuse blown, or the circuit breaker acted	Replace fuse or reset circuit breaker. Remove any other appliances sharing the same circuit with the dishwasher
	Power supply is not turned on	Make sure the dishwasher is turned on and the door is closed securely. Make sure the power cord is properly plugged into the wall socket.
	Water pressure is low	Check that the water supply is connected properly and the water is turned on.
<i>Drain pump doesn't stop</i>	Overflow	The system is designed to detect an overflow. When it does, it shuts off the circulation pump and turns on the drain pump.
<i>Noise</i>	Some audible sounds are normal	Sound from soft food shredding action and detergent cup opening.
	Utensils are not secure in the baskets or something small has dropped into the basket	Ensure everything is secured in the dishwasher.
	Motor hums	Dishwasher has not been used regularly. If you do not use it often, remember to set it to fill and pump out every week, which will help keep the seal moist.
<i>Suds in the tub</i>	Improper detergent	Use only the special dishwasher detergent to avoid suds. If this occurs, open the dishwasher and let the suds evaporate. Add 1 gallon of cold water to the tub. Close and latch the dishwasher, then drain out the water by slowly turning the dial until a drain period is reached. Repeat if necessary.
		Spilled rinse agent
<i>Stained tub interior</i>	Detergent with coloring was used	Make sure that the detergent used is without coloring.
<i>Dishes are not dry</i>	Rinse agent dispenser is empty	Make sure that the rinse agent dispenser is filled.
<i>Dishes and flatware are not clean</i>	Improper program	Select stronger program
	Improper rack loading	Make sure that the action of the detergent dispenser and spray arms are not blocked by large dishware.
<i>Spots and filming on glasses and flatware</i>	<ol style="list-style-type: none"> 1 Extremely hard water 2 Low inlet temperature 3 Overloading the dishwasher 4 Improper loading 5 Old or damp powder detergent 6 Empty rinse agent dispenser 7 Incorrect dosage of detergent 	<p>To remove spots from glassware:</p> <ol style="list-style-type: none"> 1 Remove all metal utensils from the dishwasher. 2 Do not add detergent. 3 Choose the longest cycle. 4 Start the dishwasher and allow it to run for about 18 to 22 minutes, then it will be in the main wash. 5 Open the door to pour 2 cups of white vinegar into the bottom of the dishwasher. 6 Close the door and let the dishwasher complete the cycle. If the vinegar does not work: Repeat as above, except use 1/4 cup (60 ml) of citric acid crystals instead of vinegar.

BEFORE CALLING FOR SERVICE . . .



<i>Problem</i>	<i>Possible Causes</i>	<i>What To Do</i>
<i>Glassware is cloudy</i>	Combination of soft water and too much detergent	Use less detergent if you have soft water and select a shortest cycle to wash the glassware and to get them clean.
<i>Yellow or brown film on inside surfaces</i>	Tea or coffee stains	Using a solution of 1/2 cup of bleach and 3 cups warm water to remove the stains by hand. ⚠ WARNING You have to wait for 20 minutes after a cycle to let the heating elements cool down before cleaning the interior; otherwise, burns will happen.
	Iron deposits in water can cause an overall film	Call a water softener company for a special filter.
<i>White film on inside surface</i>	Hard water minerals	To clean the interior, use a damp sponge with dishwasher detergent and wear rubber gloves. Never use any other cleaner than dishwasher detergent for the risk of foaming or suds.
<i>Detergent left in dispenser cups</i>	Dishes block detergent cups	Re-loading the dishes properly.
<i>Steam</i>	Normal phenomenon	There is some steam coming through the vent by the door latch during drying and water draining.
<i>Black or gray marks on dishes</i>	Aluminum utensils have rubbed against dishes	Use a mild abrasive cleaner to eliminate marks.
<i>Water standing in the bottom of the tub</i>	This is normal	A small amount of clean water around the outlet on the tub bottom at the back of the tub keeps the water seal lubricated.
<i>Water doesn't pump out of the tub</i>	Drain is clogged	Make sure the kitchen sink is draining well. If the dishwasher drains into a disposer, run it clear.
<i>Dishwasher leaks</i>	Overfill dispenser or rinse aid spills	Be careful not to overfill the rinse aid dispenser. Spilled rinse aid could cause oversudsing and lead to overflowing. Wipe away any spills with a damp cloth.
	Dishwasher isn't level	Make sure the dishwasher is level.

OVERFLOW CONDITIONS:

The dishwasher is designed to detect/monitor water overflow conditions. The overflow tube is located in the lower (well) section of the inner door liner. This tube must be kept free and clear of obstructions and debris. In the event of an overflow condition, the water level rises above the height of the overflow tube and is directed into the overflow container. (located at the lower right side of the dishwasher)

When the water level reaches a predetermined height, the float switch is activated closing power to the water inlet valve and automatically turns on the pump to evacuate the water inside the tub only. The accumulated water inside the float container must be discharged manually before the dishwasher can be re-started. To empty the float container, follow the instructions below.

BUILT-IN DISHWASHER (MODEL):

- Remove the kick-plate by pulling forward.
 - Disconnect the dishwasher from the electrical power supply.
 - Disconnect the flexible (braid) hose from the water inlet valve.
 - **IMPORTANT: Keep the dishwasher upright at all times.**
 - The overflow container is located at the lower right side of the dishwasher. (See Fig. 1)
 - Carefully slide out the dishwasher just enough to access the overflow container.
 - Remove the rubber plug from the bottom of the float container. (See Fig. 2)
 - Allow the water to drain into a cup/container.
 - Replace the rubber plug, making sure it is firmly secured.
 - Re-install the kick-plate.
 - Carefully slide the dishwasher back into the cabinet.
- The dishwasher is now ready to be restarted.

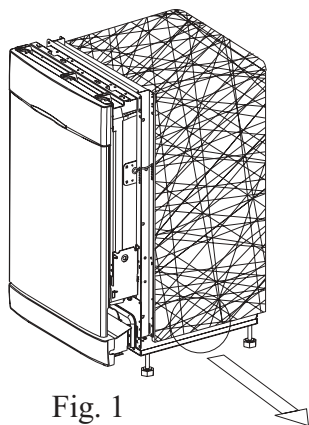

Fig. 1

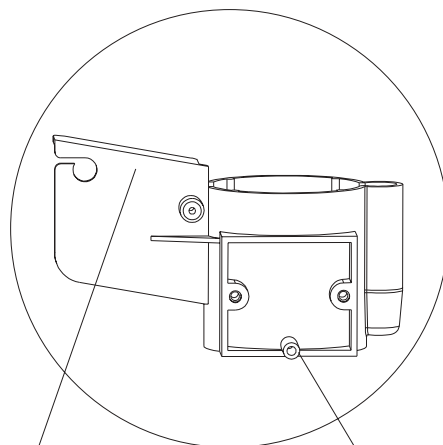

Fig. 2

Float Container

Plug

Danby[®] *Designer*

BUILT-IN DISHWASHER LIMITED IN-HOME PRODUCT WARRANTY

This quality product is warranted to be free from manufacturer's defects in material and workmanship, provided that the unit is installed and operated in compliance with the installation and operating conditions intended by the manufacturer.

This warranty is available only to the person to whom the unit was originally sold by Danby, or by an authorized distributor of Danby, and is non-transferable.

TERMS OF WARRANTY

- First Year Warranty** During the first year (1), from the original date of purchase, any electrical part(s) of this product found to be defective in materials or workmanship will be repaired or replaced, at warrantor's option, at no charge to the ORIGINAL purchaser.
- Second Year Limited Warranty** During the second year (2), from the original date of purchase any part(s) including the wash motor, drain pump, spray arms (excluding hoses/clamps) and dishracks found to be defective in materials or workmanship will be repaired or replaced, at warrantor's option, at no charge to the ORIGINAL purchaser.
- Ten Year Limited Warranty** During the third through tenth year, from the original date of purchase, any defect in material or workmanship to the stainless steel tub or stainless door liner (resulting in water leakage) will be repaired or replaced at warrantor's option.
- Stainless Steel Tub and Door Liner** This warranty is limited to the cost of replacement components only.
NOTE: The customer shall be responsible for any/all charges incurred as a result of (repair) labour cost and/or transportation (pick-up and delivery) charges associated with the repair and/or replacement of the stainless steel tub and/or stainless steel door liner.

Nothing within this warranty shall imply that Danby will be responsible or liable for any damage to any items placed in this appliance, whether due to any defect of the appliance, or its use, whether proper or improper.

EXCLUSIONS

Save as herein provided, Danby, there are no other warranties, conditions, representations or guarantees, express or implied, made or intended by Danby or its authorized distributors and all other warranties, conditions, representations or guarantees, including any warranties, conditions, representations or guarantees under any Sale of Goods Act or like legislation or statute are hereby expressly excluded. Save as herein provided, Danby, shall not be responsible for any damages to persons or property, including the unit itself, howsoever caused or any consequential damages arising from the malfunction of the unit and by the purchase of the unit, the purchaser does hereby agree to indemnify and save harmless Danby from any claim for damages to persons or property caused by the unit.

GENERAL PROVISIONS

No warranty or insurance herein contained or set out shall apply when damage or repair is caused by any of the following:

- 1) Improper Installation
- 2) Power Failure.
- 3) Damage in transit or when moving the appliance.
- 4) Improper power supply such as low voltage, defective house wiring or inadequate fuses.
- 5) Accident, alteration, abuse or misuse of the appliance such as inadequate air circulation in the room or abnormal operating conditions.
- 6) Use for commercial or industrial purposes.
- 7) Fire, water damage, theft, war, riot, hostility, acts of God such as hurricanes, floods etc.
- 8) Service calls resulting in customer education.

Proof of purchase date will be required for warranty claims; so, please retain bills of sale. In the event warranty service is required, present this document to our AUTHORIZED SERVICE AGENT.

Danby Products Ltd.
Guelph, Ontario, Canada N1H 6Z9

02/03

Danby Products Inc.
Findlay, Ohio, USA 45839-0669

Free Manuals Download Website

<http://myh66.com>

<http://usermanuals.us>

<http://www.somanuals.com>

<http://www.4manuals.cc>

<http://www.manual-lib.com>

<http://www.404manual.com>

<http://www.luxmanual.com>

<http://aubethermostatmanual.com>

Golf course search by state

<http://golfingnear.com>

Email search by domain

<http://emailbydomain.com>

Auto manuals search

<http://auto.somanuals.com>

TV manuals search

<http://tv.somanuals.com>