

Danby®

OWNER'S MANUAL

DBC128BLS

CAUTION:

Read and Follow All Safety Rules
and Operating Instructions Before
First Use of This Product.

SAVE THESE INSTRUCTIONS!

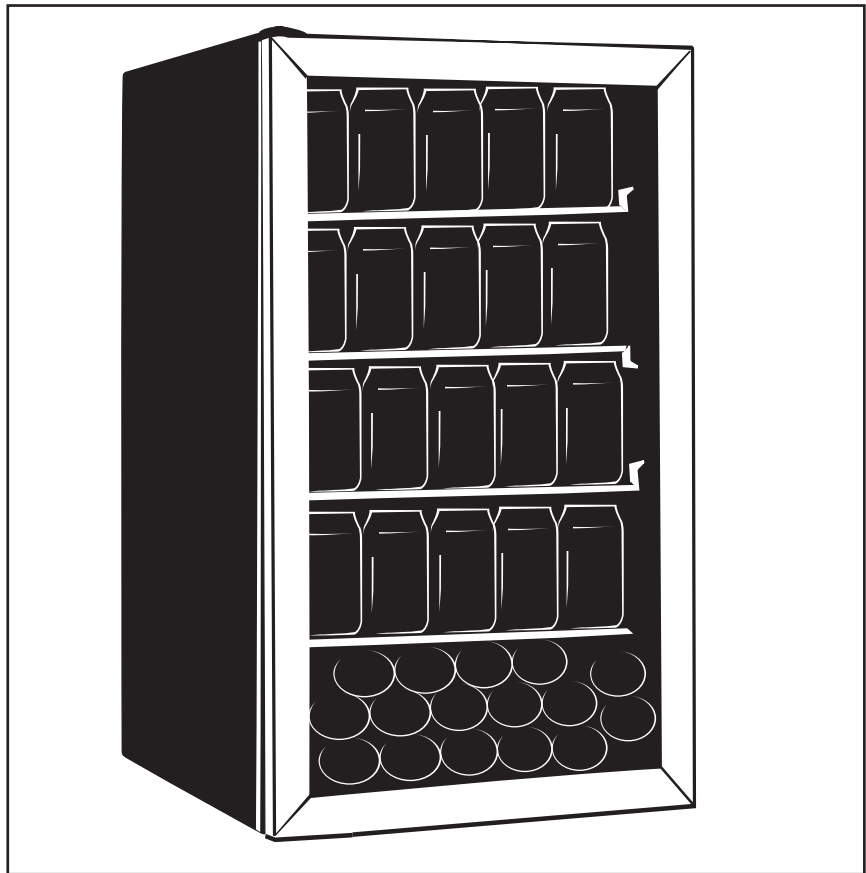

| | |
|--------------------------------|----------|
| Table of Contents | 1 |
|--------------------------------|----------|



Danby Products Limited, Guelph, Ontario Canada N1H 6Z9
Danby Products Inc., Findlay, Ohio USA 45840

Version 1.08.06

TABLE OF CONTENTS

Important Safety Information

3

| | |
|------------------------|---|
| Safety Precautions | 3 |
| Grounding Instructions | 4 |
| Location | 4 |

Operating Instructions

5

| | |
|--------------------------------------|---|
| Features of Your Beverage Center | 5 |
| The Controls of Your Beverage Center | 6 |
| Setting the Temperature | 6 |
| Can Storage | 7 |
| Shelf Instructions | 7 |

Installation Instructions

8

| | |
|---------------------|---|
| Door Swing Reversal | 8 |
|---------------------|---|

Care and Cleaning

9

| | |
|--------------------------|---|
| Helpful Hints | 9 |
| How to Clean the Inside | 9 |
| How to Clean the Outside | 9 |

Trouble Shooting

10

| | |
|------------------------------|----|
| Before Your Call For Service | 10 |
|------------------------------|----|

WELCOME

Welcome to the Danby family. We're proud of our quality products and we believe in dependable service.

You'll see it in this easy-to-use manual and you'll hear it in the friendly voices of our consumer service department. **Danby**[®]
Tel: 1-800-26-

Best of all, you'll experience these values each time you use your Beverage Center. That's important, because your new appliance will be part of your family for a long time.

Start Here!...Before using your Beverage Center

Write down the model and serial numbers here. They are on a label located on the back of the appliance.

Model number **DBC128BLS**

Serial number _____

Date purchased _____

Staple your receipt to the inside back cover of this manual. You will need it to obtain service under warranty.

NEED HELP?

Before you call for service, there are a few things you can do to help us serve you better...

Read this manual

It contains instructions to help you use and maintain your Beverage Center properly.

If you received a damaged appliance

Immediately contact the dealer (or builder) that sold you the appliance.

Save time and money

Check the Trouble Shooting section before calling. This section helps you solve common problems that may occur.

If you do need service, you can relax knowing help is only a phone call away.

Tel: 1-800-26-**Danby**[®]

IMPORTANT SAFETY INFORMATION

READ ALL SAFETY INFORMATION BEFORE USING

WARNING

DANGER, RISK OF CHILD ENTRAPMENT!

An empty refrigerator is a very dangerous attraction to children. Remove either the gasket, latches, lids, lock and/or doors from unused or discarded appliances, or take some other action to guarantee it harmless.

DON'T WAIT, DO IT NOW!

To reduce the risk of fire, burns, electric shock, or injury to persons when using your appliance, follow basic precautions, including the following sections:

SAFETY PRECAUTIONS

- This appliance must be grounded. Connect only to a properly grounded outlet. See "Grounding Instructions" section on page 4.
- Do not operate this appliance if it has a damaged power cord or plug, if it is not working properly, or if the appliance has been damaged or dropped.
- Do not splice the power cord that is equipped with this appliance.
- Keep power cord away from heated surfaces.
- Do not immerse power cord, plug or the appliance itself in water.
- Do not use this product near water—for example, in a wet basement, near a swimming pool or near a sink.
- Do not use corrosive chemicals or vapors in this appliance.
- Use this appliance only for its intended use, as described in this manual.
- Do not store perishable food items such as (but not limited to) meats and dairy products in your Beverage Center.
- See door surface cleaning instructions in the Care and Cleaning section(s) of this manual.
- Do not cover or block any openings on the appliance.
- This appliance should be serviced only by qualified service personnel. Contact the nearest authorized service facility for examination, repair or adjustment.

SAVE THESE INSTRUCTIONS

IMPORTANT SAFETY INFORMATION

GROUNDING INSTRUCTIONS

WARNING

Improper use of the grounding plug can result in a risk of electric shock.

This appliance must be grounded. In the event of an electrical short circuit, grounding reduces the risk of electric shock by providing an escape wire for the electric current.

This appliance is equipped with a power cord having a grounding wire with a grounding plug. The plug must be plugged into an outlet that is properly installed and grounded.

Consult a qualified electrician or service technician if the grounding instructions are not completely understood, or if doubt exists as to whether the appliance is properly grounded.

If the outlet is a standard 2-prong wall outlet, it is your personal responsibility and obligation to have it replaced with a properly grounded 3-prong wall outlet.

For best operation, plug this appliance into its own electrical outlet to prevent flickering of lights, blowing of fuse or tripping of circuit breaker.

Do not under any circumstances cut or remove the third (ground) prong from the power cord.

Do not use an adapter plug with this appliance.

Do not use an extension cord with this appliance. If the power cord is too short, have a qualified electrician or service technician install an outlet near the appliance.

LOCATION

DO...

- ✓ • Select a location with a strong, level floor.
- ✓ • Allow 5 inches of space between the back of the appliance and any adjacent wall.
- ✓ • Avoid direct sunlight and heat. Direct sunlight may affect the acrylic coating, Heat sources nearby will cause higher electricity consumption.

DO NOT...

- ⊘ • **Use this appliance outdoors:** This appliance is intended for *household use only*. Do not attempt to operate or store this appliance outdoors.
- ⊘ • **Build this appliance into an enclosure:** This appliance is designed for a free-standing application only and is not intended to be “built-in”.

Operating Instructions

Features of your Beverage Center

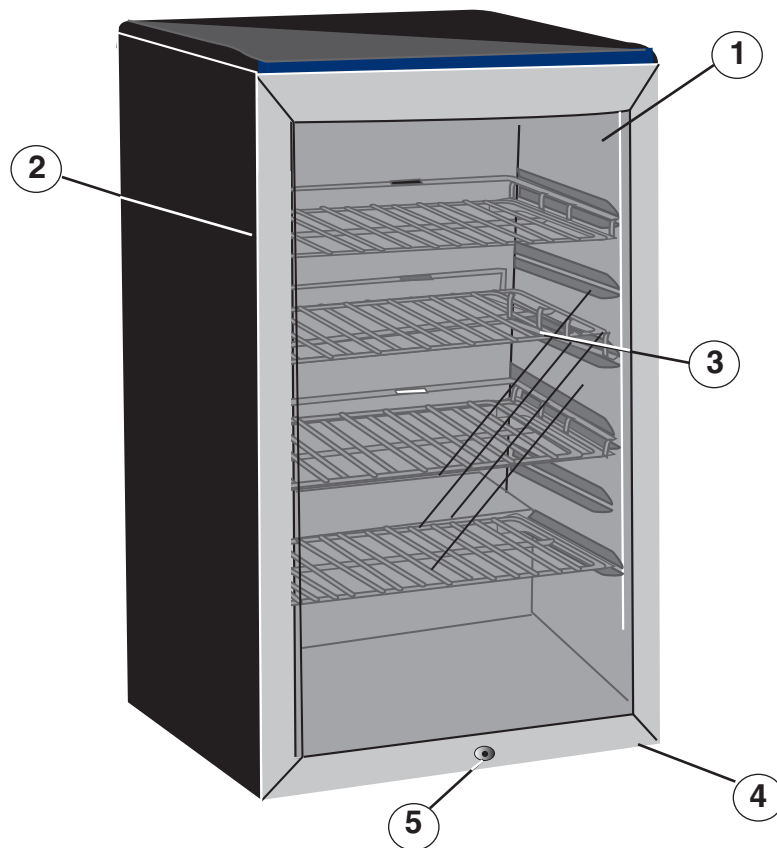

1. Tempered Glass Door: Tinted for UV protection while still allowing for easy interior viewing.

2. Magnetic Door Gasket: Tight fitting seals retain all the cooling power.

3. Plastic Coated Wire Shelves

4. Leveling Leg

5. Child Proof Lock with Key

6. Interior Light (*not shown*): Illuminates the compartment when the door is opened.

Operating Instructions

The Controls of your Beverage Center

To start the Beverage Center, turn the temperature control to the position corresponding to the desired cooling. The Beverage Center temperature will vary depending on the quantity of cans stored and on the frequency with which the door is opened.

Setting The Temperature Control:

The temperature of the Beverage Center compartment is controlled by adjusting/setting the thermostat control knob, located on the exterior rear wall of the cabinet.

To start the Beverage Center and achieve maximum cooling quickly;

- Turn the temperature control knob clockwise to the furthest (maximum) setting on the darker blue (wide) section of the graduated control dial.
- Allow the unit to run at this setting for 3-4 hours.
- When maximum cooling is achieved, turn back the temperature control knob setting to the 2 o'clock position on the graduated blue control dial. See fig.15.
- To turn off the beverage center, (no cooling) rotate the control knob to the "0" (off) position. See fig.14

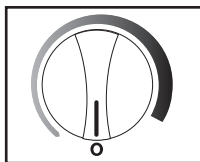

Fig. A

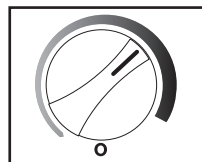

Fig. B

Turn the control to the "OFF" (0) position to temporarily disconnect the cooling cycle. When the beverage center is not to be used for a long period of time, disconnect the plug and leave the door partially open.

NOTE: Wait 3 to 5 minutes before restarting if operation has been interrupted.

Interior Light:

The operation of the interior light can be "manually" controlled as well as controlled with the opening or closing of the door.

To manually operate the light; depress the interior light toggle switch situated on the left side of the interior light housing located on the ceiling of inner cabinet (*as shown in Figure C*) this will allow the interior light to remain on, while the door is closed.

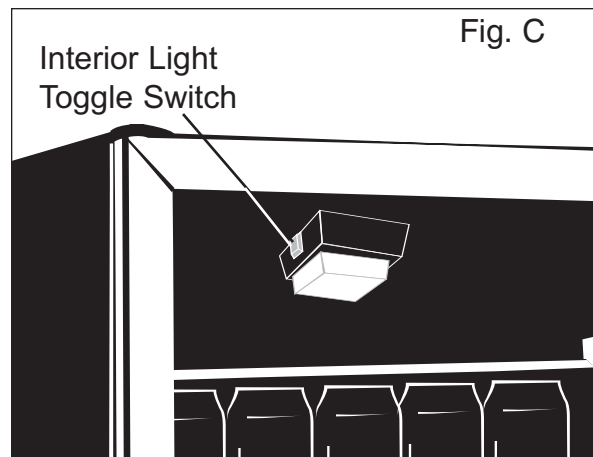

Defrosting:

Your beverage center is designed with an "Auto-Cycle" defrost system. *What is Auto Cycle defrost?*

The refrigerated surfaces of the fresh food compartment defrost automatically, during the "off" cycle of the cold control. (thermostat) Defrost water from the fresh food compartment is disposed of automatically, by means of being channeled onto a drip tray located on the compressor. Heat transfer from the compressor causes the defrost water to evaporate.

Operating Instructions

Can Storage

The * *maximum* capacity of the DBC128 is 128 (355ml) cans.

* *When stocked as per instructions.*

In order to achieve the maximum storage capacity of 128 cans, it will be necessary to position the cans in the following manner;

- Twenty-two (22) cans upright on the top shelf surrounding the interior light.
- Twenty-five (25) cans upright on each of the center 3 shelves.
- Thirty-two (32) cans laying on the bottom of the cabinet (as shown in Fig D).

This will allow for a total storage capacity of one-hundred and twenty-eight (128) 355 ml cans.

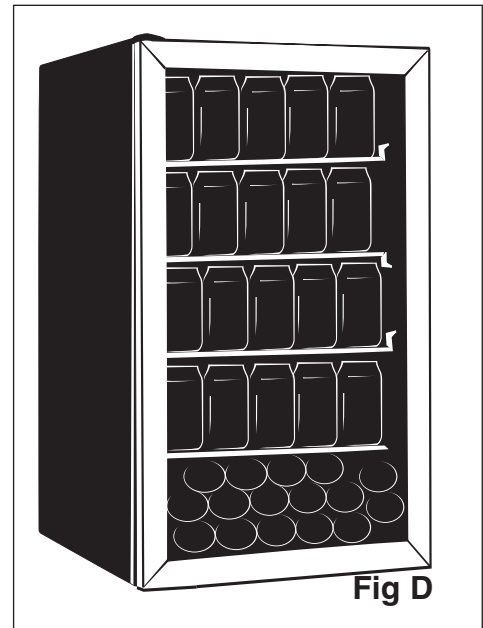

Shelf Instructions

IMPORTANT!

Do not cover shelves with aluminum foil or any other material that will prevent adequate air circulation within the cabinet.

To remove a shelf from its locked position, tilt the rear portion of the shelf up and pull outward.

To re-install, ensure the shelf is resting securely on the support brackets and push shelf inward until it locks into place.

Please Note: Each of the top three staggered shelves have a color coded marker on the rear rail. In order to stock the beverage cans as per the above "Can Storage" instructions, it will be necessary to install the shelves as shown in Figure E. The correct positioning of shelves should allow you to easily place a standard 355 ml beverage can upright between each shelf.

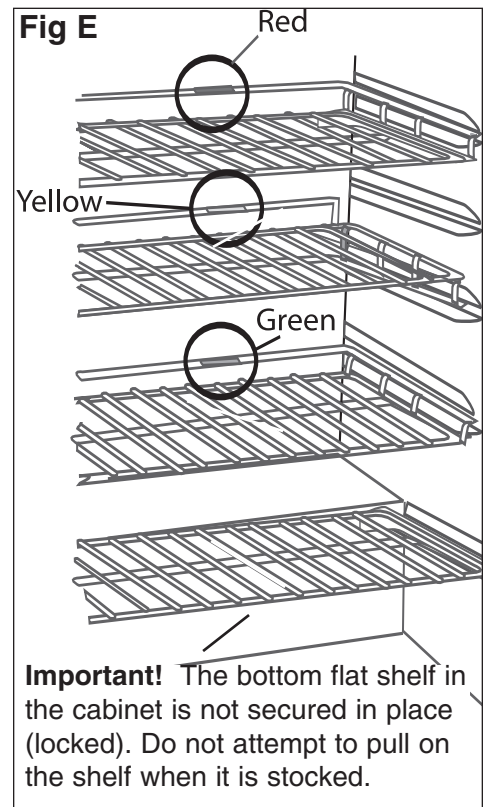

Installation Instructions - Door Swing Reversal

1. Unplug the unit from the electrical outlet (if connected) and lay it on it's back.
2. Remove the screws from the lower hinge assembly as shown in **Figure F**.
3. Pull the door downward to remove it from the cabinet of the Beverage Center.
4. Remove the cap from the top left side of the door (**Fig G**) and reinstall it on the top right side.
5. Remove the three (3) screws supporting the top hinge (**Fig H**).
6. Remove the plastic caps from the left side of the frame (**Fig I**) and reinstall them on the right side of the frame (the previous hinge location).
9. Install the upper hinge assembly on the left side of the frame.
10. Carefully reposition the door firstly into the upper hinge assembly then onto the cabinet.
11. While the door remains closed install the lower hinge assembly.
12. Close the door and return the unit into it's upright position (**wait 60 mins before re-connecting power to the beverage center**), verify the door alignment and proper seal against the cabinet.

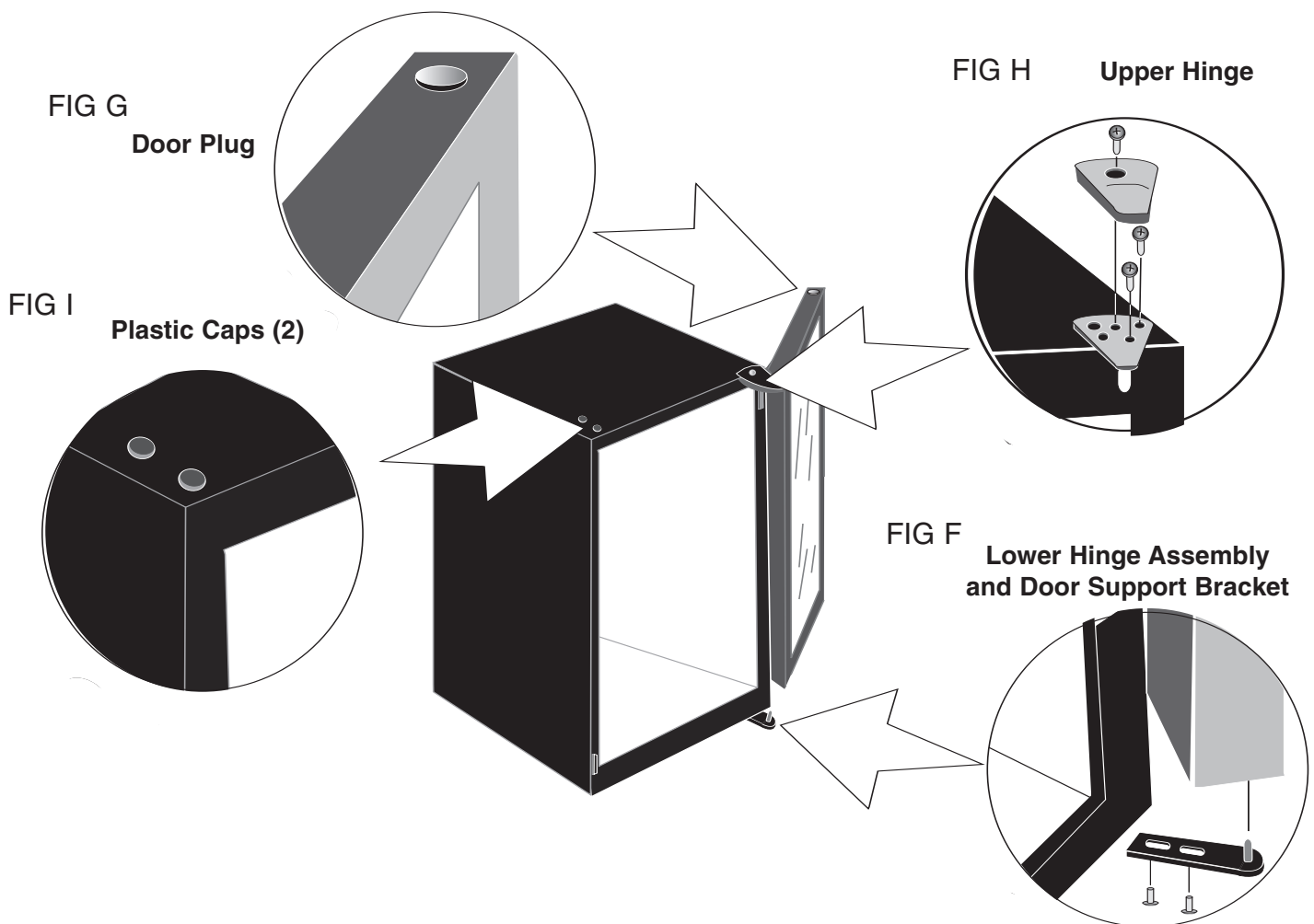

Care and Cleaning

Helpful Hints

Allow the Beverage Center door to remain open for a few minutes after manual cleaning to air out and dry the inside of the beverage center cabinet

NOTE: Be certain the power is off before cleaning any part of this appliance.

How to Clean the Inside

Walls, Floor, Inside Window, and Shelves

Never use any commercial or abrasive cleaners or sharp objects on any part of this appliance.

Water deposits and dust can should be removed with a damp cloth.

How to Clean the Outside

Do not use cleaners containing ammonia or alcohol on the Beverage Center.

Ammonia or alcohol can damage the appearance of the appliance.

Outer Case

It's important to keep the area clean where the door seals against the cabinet. Clean this area with a sudsy cloth. Rinse and then dry.

Door Glass

Wipe the door with a damp cloth and dry thoroughly. Do not use abrasive or sharp objects on the door glass, they can damage it.

Door Trim

Use only mild, non-abrasive detergents applied with a clean sponge or soft cloth. Rinse well.

Trouble Shooting

Before You Call For Service

| Problem | Possible Cause | What to do |
|--|--|---|
| No Power. | A fuse in your home may be blown or the circuit breaker tripped. | Replace fuse or reset circuit breaker. |
| | Power surge. | Unplug the appliance, wait a few seconds and then plug it back in. |
| | Plug not fully inserted into wall outlet | Make sure the 3-prong plug on the appliance is fully inserted into outlet. |
| Cabinet Temperature too High | Temperature setting | Verify the temperature control setting. adjust if necessary. |
| | Door not shut properly or opened excessively | Ensure that the door is fully closed and that the gaskets are sealing, against the cabinet. Open the door only as needed and for short periods of time. |
| | Recently added a large quantity of warm cans to the cabinet | Limit the quantity of warm cans being introduced to the cabinet at the same time. |
| “Clicking” Noise | Normal sound | No user intervention is required as this sound is normal during the operation of the appliance. This audible ‘clicking’ noise may be heard as the appliance ends or begins a cooling cycle. |
| Condensation on the cabinet and/or door | High humidity conditions in the home. | The condensation will subside once humidity conditions return to normal. |
| | Door not shut properly or opened excessively | Ensure that the door is fully closed and that the gaskets are sealing, against the cabinets. Open the door only as needed and for short periods of time. |

If none of the above rectify the situation please contact our customer care department at **1-800-26-Danby® (1-800-263-2629)**



LIMITED COMPACT REFRIGERATOR WARRANTY

This quality product is warranted to be free from manufacturer's defects in material and workmanship, provided that the unit is used under the normal operating conditions intended by the manufacturer.

This warranty is available only to the person to whom the unit was originally sold by Danby or by an authorized distributor of Danby, and is non-transferable.

TERMS OF WARRANTY

Plastic parts, are warranted for thirty (30) days only from purchase date, with no extensions provided.

First 12 Months During the first twelve (12) months, any electrical parts of this product found to be defective, including any sealed system units, will be repaired or replaced, at warrantor's option, at no charge to the ORIGINAL purchaser.

Additional 48 Months During the next forty-eight (48) months any part of the sealed system found to be defective (consisting of compressor, condenser, evaporator, dryer and all related tubing) will be replaced without charge. The purchaser shall pay for all labor and return freight during this period for repair or replacement of any sealed system components. Any unit being diagnosed as non-functional due to sealed system failure and warranting an exchange will be subject to an appropriate depreciation or user fee, including any and all freight charges being levied against the consumer.

To obtain Service Danby reserves the right to limit the boundaries of "In Home Service" to the proximity of an Authorized Service Depot. Any appliance requiring service outside the limited boundaries of "In Home Service", it will be the consumer's responsibility to transport the appliance (at their own expense) to the original retailer (point of purchase) or a service depot for repair. Contact your dealer from whom your unit was purchased, or contact your nearest authorized Danby service depot, where service must be performed by a qualified service technician. If service is performed on the units by anyone other than an authorized service depot, or the unit is used for commercial application, all obligations of Danby under this warranty shall be at an end.

Nothing within this warranty shall imply that Danby will be responsible or liable for any spoilage or damage to food or other contents of this appliance, whether due to any defect of the appliance, or its use, whether proper or improper.

EXCLUSIONS

Save as herein provided, Danby Products Limited (Canada) or Danby Products Inc. (U.S.A.), there are no other warranties, conditions, representations or guarantees, express or implied, made or intended by Danby Products Limited or its authorized distributors and all other warranties, conditions, representations or guarantees, including any warranties, conditions, representations or guarantees under any Sale of Goods Act or like legislation or statute is hereby expressly excluded. Save as herein provided, Danby Products Limited (Canada) or Danby Products Inc. (U.S.A.), shall not be responsible for any damages to persons or property, including the unit itself, howsoever caused or any consequential damages arising from the malfunction of the unit and by the purchase of the unit, the purchaser does hereby agree to indemnify and save harmless Danby Products Limited from any claim for damages to persons or property caused by the unit.

GENERAL PROVISIONS

No warranty or insurance herein contained or set out shall apply when damage or repair is caused by any of the following:

- 1) Power Failure.
- 2) Damage in transit or when moving the appliance.
- 3) Improper power supply such as low voltage, defective house wiring or inadequate fuses.
- 4) Accident, alteration, abuse or misuse of the appliance such as inadequate air circulation in the room or abnormal operating conditions, (extremely high or low room temperature).
- 5) Use for commercial or industrial purposes.
- 6) Fire, water damage, theft, war, riot, hostility, acts of God such as hurricanes, floods etc.
- 7) Service calls resulting in customer education.

Proof of purchase date will be required for warranty claims; so, please retain bills of sale. In the event warranty service is required, present this document to our

Warranty Service

In Home Service on models 3.0 cu. ft. or greater.

Danby Products Limited
PO Box 1778, 5070 Whitelaw RD, Guelph, Ontario, Canada N1H 6Z9
Telephone: (519) 837-0920 FAX: (519) 837-0449

Danby Products Inc.
PO Box 669, 101 Bentley Court, Findlay, Ohio, U.S.A. 45840
Telephone: (419) 425-8627 FAX: (419) 425-8629

06/06



Model
DBC128BLS

For service, contact your nearest service depot or call:

1-800-26-Danby®
(1-800-263-2629)

to recommend a depot in your area.

Free Standing Beverage Center

The model number can be found on the serial plate located on the back panel of the unit.

All repair parts available for purchase or special order when you visit your nearest service depot. To request service and/or the location of the service depot nearest you, call the TOLL FREE NUMBER.

When requesting service or ordering parts, always provide the following information:

- Product Type
- Model Number
- Part Description

Free Manuals Download Website

<http://myh66.com>

<http://usermanuals.us>

<http://www.somanuals.com>

<http://www.4manuals.cc>

<http://www.manual-lib.com>

<http://www.404manual.com>

<http://www.luxmanual.com>

<http://aubethermostatmanual.com>

Golf course search by state

<http://golfingnear.com>

Email search by domain

<http://emailbydomain.com>

Auto manuals search

<http://auto.somanuals.com>

TV manuals search

<http://tv.somanuals.com>