

# LUXMAN

## LR-6500

### 6.1 CHANNEL AV RECEIVER

#### OWNER'S MANUAL

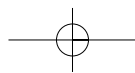
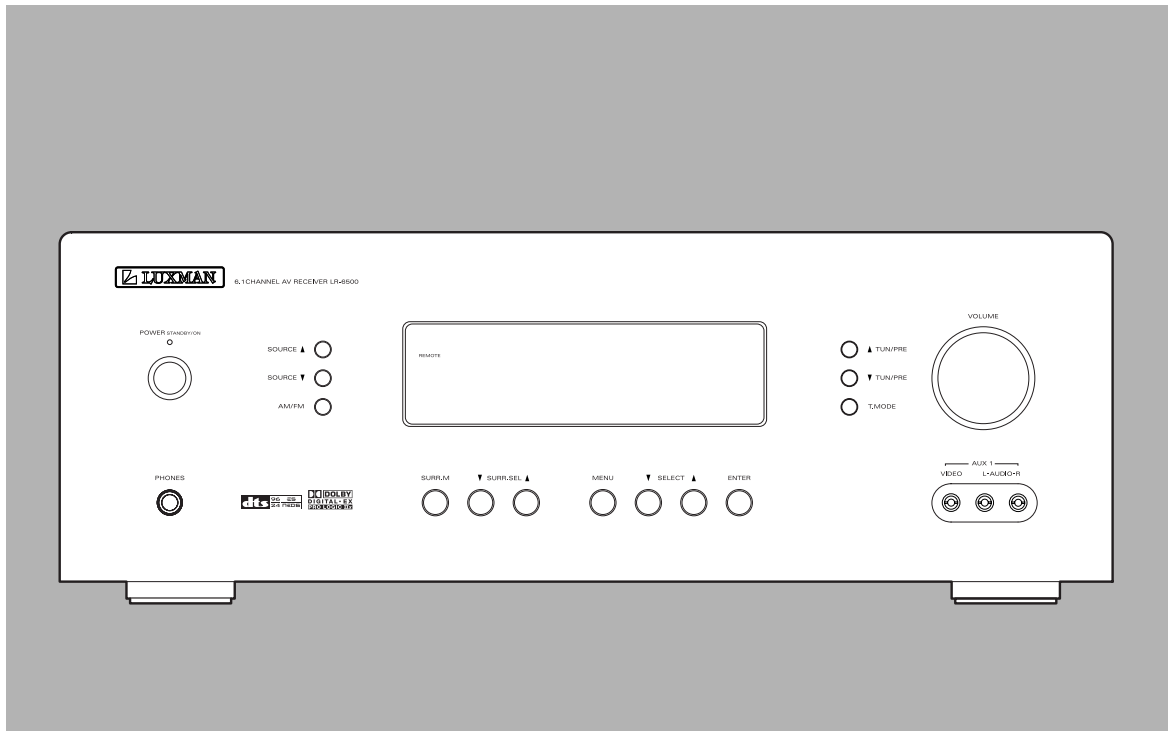

## Important Safety Instructions

### IMPORTANT(for U.K.Customers)

DO NOT cut off the mains plug from this equipment. If the plug fitted is not suitable for the power points in your home or the cable is too short to reach a power point, then obtain an appropriate safety approved extension lead or consult your dealer.

If nonetheless the mains plug is cut off, remove the fuse and dispose of the plug immediately, to avoid a possible shock hazard by inadvertent connection to the mains supply.

If this product is not provided with a mains plug, or one has to be fitted, then follow the instructions given below:

**IMPORTANT.** DO NOT make any connection to the larger terminal which is marked with the letter E or by the safety earth symbol  $\perp$  or coloured GREEN or GREEN-and-YELLOW.

The wires in the mains lead on this product are coloured in accordance with the following code:

BLUE : NEUTRAL  
BROWN : LIVE

As these colours may not correspond with the coloured markings identifying the terminals in your plug proceed as follows:

The wire which is coloured BLUE must be connected to the terminal which is marked with the letter N or coloured BLACK.

The wire which is coloured BROWN must be connected to the terminal which is marked with the letter L or coloured RED.

When replacing the fuse only a correctly rated approved type should be used and be sure to re-fit the fuse cover.

IF IN DOUBT — CONSULT A COMPETENT ELECTRICIAN.

### CAUTION

The product shall not be exposed to dripping or splashing and that no object filled with liquids, such as vases, shall be placed on the product.

Do not install this equipment in a confined space such as a book case or similar unit.



This symbol means that the product is double insulated and you do not need an earth connection



This symbol means that this product keeps to the European safety and electrical interference directives



### CAUTION

RISK OF ELECTRIC SHOCK  
DO NOT OPEN



## **Table of Contents**

**Thanks for choosing LUXMAN.  
Read this manual carefully to get the best performance from this unit.**

Before Use .....	4	PTY .....	22
Description.....	5	Video Operations .....	23
Connections.....	6	System Configuration.....	23
- Speakers, PRE OUT, AC OUTLET .....	8	- Function Setup.....	24
- Audio Components.....	9	- Surround Setup.....	24
- Video Components .....	10	- Dolby Surround.....	25
- Advanced Connecting .....	11	- Speaker Setup .....	25
- Antennas.....	12	- Distance Adjust .....	26
Control Functions.....	13	- CH Level Adjust.....	27
Basic Operations .....	16	- Preference Setup.....	27
Surround Mode .....	18	Controlling other Components Connected to the LR-6500 .....	28
Night Mode .....	18	Programming the Remote.....	29
Speaker Configuration .....	19	Troubleshooting .....	34
Tuner Operation .....	21	Specifications.....	35
RDS.....	22		

## Before Use

### Read this before operation

- As the unit may become warm during operation, always leave sufficient space above the unit for ventilation.
- The voltage supplied to the unit should match the voltage as printed on the rear panel. If you are in any doubt regarding this matter, consult an electrician.
- Choose the installation location of your unit carefully. Avoid placing it in direct sunlight or close to a source of heat. Also avoid locations subject to vibrations and excessive dust, heat, cold or moisture.
- Do not open the cabinet as this might result in damage to the circuitry or electrical shock. If a foreign object should get into the set, contact your dealer.
- When removing the power plug from the wall outlet, always pull directly on the plug, never yank the cord.
- Do not attempt to clean the unit with chemical solvents as this might damage the finish. Use a clean, dry cloth.
- Keep this manual in a safe place for future reference.

### Back-up Memory Function

This is the function which preserves the preset memory and most-recent memory functions. In the event of a power failure, or if the power cord of this unit is disconnected from the electric outlet, the back-up memory will preserve the preset memory and most-recent memory functions for as long as approximately 15 days.

If the power supply is interrupted for 15 days or longer, the memory settings will be erased.

### When to Use RESET

- When this system is subjected to an electrical shock.
- When the power is irregular.  
In these cases, try the following

**Press the ENTER button for more than 5 seconds.**

### Note:

If the ENTER button is pressed for more than 5 seconds Standby mode, all the memory will be erased.

## Before Connection

### CAUTION

Turn off the power of all the equipment before making connections.  
Read instructions of each component you intend to use with this unit.

- Be sure to insert each plug securely. To prevent hum and noise, do not bundle the connection cords with the power cord or speaker cord.

## Description



DTS was introduced in 1994 to provide 5.1 channels of discrete digital audio into home theater systems.

DTS brings you premium quality discrete multi-channel digital sound to both movies and music.

DTS is a multi-channel sound system designed to create full range digital sound reproduction.

The no compromise DTS digital process sets the standard of quality for cinema sound by delivering an exact copy of the studio master recordings to neighborhood and home theaters.

Now, every moviegoer can hear the sound exactly as the moviemaker intended.

DTS can be enjoyed in the home for either movies or music on of DVD's, LD's, and CD's.

"DTS" and "DTS Digital Surround" are registered trademarks of Digital Theater Systems, Inc.



The advantages of discrete multichannel systems over matrix are well known.

But even in homes equipped for discrete multichannel, there remains a need for high-quality matrix decoding. This is because of the large library of matrix surround motion pictures available on disc and on VHS tape; and analog television broadcasts.

The typical matrix decoder of today derives a center channel and a mono surround channel from two-channel matrix stereo material. It is better than a simple matrix in that it includes steering logic to improve separation, but because of its mono, band-limited surround it can be disappointing to users accustomed to discrete multichannel.

Neo:6 offers several important improvements as follow.

- Neo:6 provides up to six full-band channels of matrix decoding from stereo matrix material. Users with 6.1 and 5.1 systems will derive six and five separate channels, respectively, corresponding to the standard home-theater speaker layouts.
- Neo:6 technology allows various sound elements within a channel or channels to be steered separately, and in a way which follows naturally from the original presentation.
- Neo:6 offers a music mode to expand stereo nonmatrix recordings into the five-or six-channel layout, in a way which does not diminish the subtlety and integrity of the original stereo recording.



DTS-ES Extended Surround is a new multi-channel digital signal format developed by Digital Theater Systems Inc. While offering high compatibility with the conventional DTS Digital Surround format, DTS-ES Extended Surround greatly improves the 360-degree surround impression and space expression thanks to further expanded surround signals. This format has been used professionally in movie theaters since 1999.

In addition to the 5.1 surround channels (FL, FR, C, SL, SR and LFE), DTS-ES Extended Surround also offers the SB (Surround Back) channel for surround playback with a total of 6.1 channels. DTS-ES Extended Surround includes two signal formats with different surround signal recording methods, as DTS-ES Discrete 6.1 and DTS-ES Matrix 6.1.

"DTS", "DTS-ES Extended Surround" and "Neo:6" are trademarks of Digital Theater Systems, Inc.



The stereo CD is a 16-bit medium with sampling at 44.1 kHz. Professional audio has been 20- or 24-bit for some time, and there is increasing interest in higher sampling rates both for recording and for delivery into the home. Greater bit depths provide extended dynamic range. Higher sampling rates allow wider frequency response and the use of anti-alias and reconstruction filters with more favorable aural characteristics.

DTS 96/24 allows for 5.1 channel sound tracks to be encoded at a rate of 96kHz/24bits on DVD Video titles.

When DVD-video appeared, it became possible to deliver 24-bit, 96 kHz audio into the home, but only in two channels, and with serious limitations on picture. This capability has had little use.

DVD-audio allows 96/24 in six channels, but a new player is needed, and only analog outputs are provided, necessitating the use of the D/A converters, and analog electronics provided in the player.

DTS 96/24 offers the following:

1. Sound quality transparent to the original 96/24 master.
2. Full backward compatibility with all existing decoders. (Existing decoders will output a 48 kHz signal)
3. No new player required: DTS 96/24 can be carried on DVD-video, or in the video zone of DVD-audio, accessible to all DVD players.
4. 96/24 5.1-channel sound with full-quality full motion video, for music programs and motion picture soundtracks on DVD-video.

"DTS" and "DTS 96/24" are trademarks of Digital Theater Systems, Inc.

## Description



Dolby Digital identifies the use of Dolby Digital audio coding for such consumer formats as DVD and DTV. As with film sound, Dolby Digital can provide up to five full-range channels for left, center, and right screen channels, independent left and right surround channels, and a sixth (".1") channel for low-frequency effects.

Dolby Surround Pro Logic II is an improved matrix decoding technology that provides better spatiality and directionality on Dolby Surround program material; provides a convincing three-dimensional soundfield on conventional stereo music recordings; and is ideally suited to bring the surround experience to automotive sound. While conventional surround programming is fully compatible with Dolby Surround Pro Logic II decoders, soundtracks will be able to be encoded specifically to take full advantage of Pro Logic II playback, including separate left and right surround channels. (Such material is also compatible with conventional Pro Logic decoders.)

Dolby Digital EX creates six full-bandwidth output channels from 5.1-channel sources. This is done using a matrix decoder that drives three surround channels from the two in the original recording. For best results, Dolby Digital EX should be used with movies soundtracks recorded with Dolby Digital Surround EX.

### About Dolby Pro Logic IIx

Dolby Pro Logic IIx technology delivers a natural and immersing 7.1-channel listening experience to the home theater environment. A product of Dolby's expertise in surround sound and matrix decoding technologies, Dolby Pro Logic IIx is a complete surround sound solution that maximizes the entertainment experience from stereo as well as 5.1-channel encoded sources.

## Connections

### SPEAKER PLACEMENT

The ideal surround speaker system for this unit is 7-speaker systems, using front left and right speakers, a center speaker, surround left and right speakers, surround back left and right speakers, and a subwoofer.

For best results we recommend that all front speakers be of the same type, with identical or similar driver units. This will deliver smooth pans across the front sound stage as the action moves from side to side.

Your center channel speaker is very important as over 80 % of the dialog from a typical motion picture emanates from the center channel.

It should possess similar sonic characteristics to the main speakers. Surround channel speakers need not be identical to the front channel speakers, but they should be of high quality.

The surround center speaker is useful for playback of Dolby Digital Surround EX or DTS-ES. One of the benefits of both Dolby Digital and DTS is that surround channels are discrete full range, while they were frequency limited in earlier "Pro Logic" type systems.

Bass effects are an important part of home theater.

For optimal enjoyment a subwoofer should be used as it is optimized for low frequency reproduction. If you have full range front speakers, however, they may be used in place of a subwoofer with proper setting of the switches in the menu system.

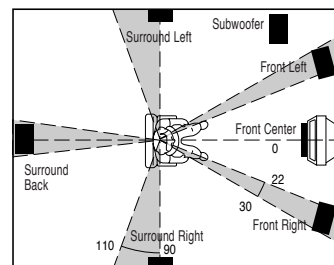

#### Front left and right speakers

We recommend to set the front L and R speakers with 45-60 degrees from the listening position.

#### Center speaker

Align the front line of the center speaker with the front L/R speakers. Or place the center speaker a little backward from the line.

#### Surround left and right speakers

When the LR-6500 is used in surround operation, the preferred location for surround speakers are on the side walls of the room, at or slightly behind the listening position.

The center of the speaker should face into the room.

## Connections

### Surround back speakers

Surround back speakers are required when a full 7.1-channel system is installed.

Speakers should be placed on a rear wall, behind the listening position.

The center of the speaker should face into the room.

### Subwoofer

We recommend using a subwoofer to have maximum bass effect. Subwoofer bears only low frequency range so you can place it any where in the room.

### HEIGHT OF THE SPEAKER UNITS

#### Front left and right speakers, and a center speaker

Align the tweeters and mid-range drivers on the three front speakers at the same height, as best as possible.

#### Surround left and right speakers, and surround back speaker

Place the surround left, right and surround back speakers higher than your ears by about 70cm - 1m.

Also place the speakers at the same height, as best as possible.

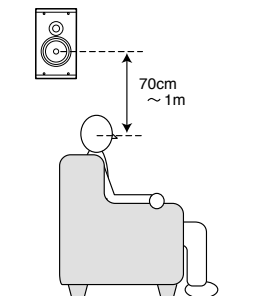

#### Note:

- Use magnetically-shielded speakers for front left, right and the center speakers when the speakers are installed near the TV and the TV is a monitor type.

### CONNECTING SPEAKER WIRE

1. Strip away approx. 10 mm of wire insulation.
2. Twist the bared wire ends tight, to prevent short circuits.
3. Loosen the knob by turning it counterclockwise.
4. Insert the bare part of the wire into the hole in side of each terminal.
5. Tighten the knob by turning it clockwise to secure the wire.

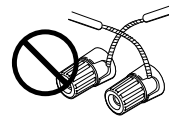
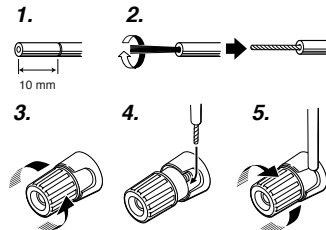

#### Caution:

- Be sure to use speakers with the specified impedance as shown on the rear panel of this unit.
- To prevent damage to circuitry, do not let the bare speaker wires touch each other and do not let them touch any metal part of this unit.
- Do not touch the speaker terminals when the power is on. It may cause you to receive an electric shocks.
- Do not connect more than one speaker cable to one speaker terminal. Doing so may damage this unit.

#### Note:

- Be sure to connect the positive and negative cables for the speaker properly. If they are miss connected, the signal phase will be reversed and the signal quality will be corrupted.

### CONNECTING A SUBWOOFER

Use the PRE OUT SUBWOOFER jack to connect a powered subwoofer (power amplifier built in ).

If your subwoofer is a passive type (power amplifier is not built in), connect a monaural power amplifier to the PRE OUT SUBWOOFER jack and connect the subwoofer to the amplifier.

## Connections

### SPEAKERS, PRE OUT, AC OUTLET

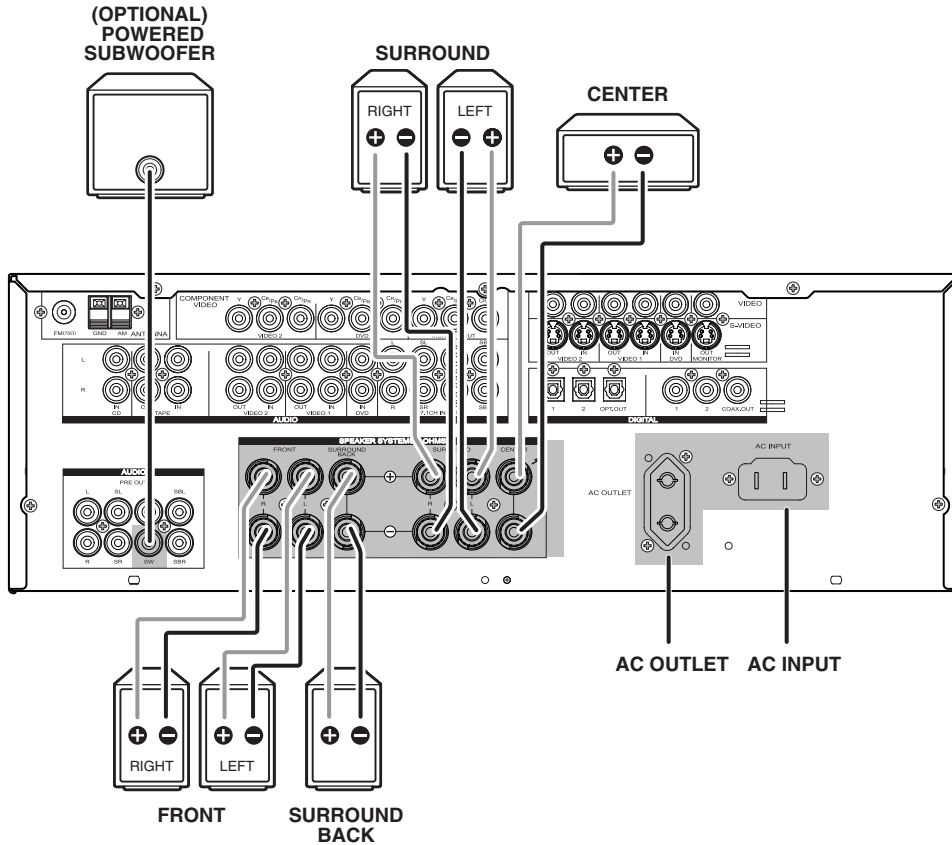

#### PRE OUT ( SUB WOOFER ) jack

Use this jack to connect a powered sub-woofer or passive sub-woofer with a power amplifier (OPTIONAL).

#### Power cord (AC INPUT)

Be sure to connect the power cord to an AC outlet which supplies the correct voltage.

Hold the power plug when plugging or unplugging the power cord.

#### AC OUTLET (SWITCHED)

This outlet is only active when the receiver is turned on.

#### Caution:

Make sure that the total power consumption of all equipment connected to the outlets on the receiver does not exceed 100 watts.



## Connections

### AUDIO COMPONENTS

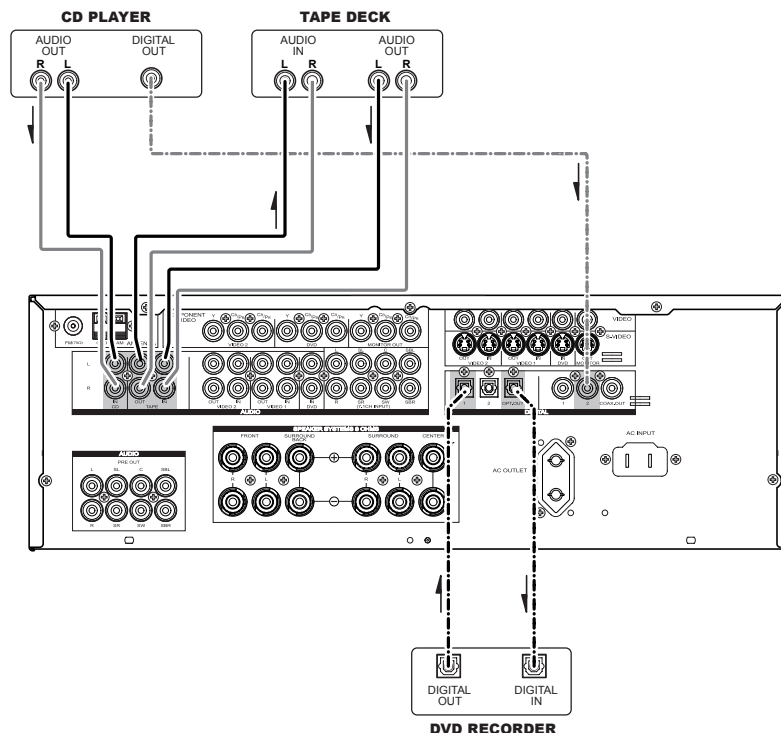

The output audio signal from the TAPE OUT jack is the same signal which is currently selected.

#### Caution:

- Do not connect this unit and other components to mains power until all connections between components have been completed.

#### Notes:

- Insert all plugs and connectors securely. Incomplete connections may make noise.
- Be sure to connect the left and right channels properly. Red connectors are for the R (right) channel, and white connectors are for the L (left) channel.
- Be sure to connect input and output properly.
- Refer to the instructions for each component that is connected to this unit.
- Do not bind audio/video connection cables with power cords and speaker cables this will result in generating a hum or other noise.

### CONNECTING DIGITAL AUDIO COMPONENTS

- There are 4 digital inputs, 2 coaxial jacks and 2 optical jacks, on the rear panel. You can use these jacks to input PCM, Dolby Digital and DTS bitstream signals from a CD, DVD, or other digital source components.
- There is one digital output coaxial jack and one optical output jack on the rear panel. These jacks can be connected to a CD recorder, DVD recorder, or a MD deck inputs, respectively.
- Refer to the instructions for each component. To setup the digital audio format of DVD player, or other digital source's connected to digital input jacks.
- You can designate the input for each digital input/output jacks according to your component.

#### Notes:

- There is no Dolby Digital RF input jack. Please use an external RF demodulator Dolby Digital decoder when connecting the Dolby Digital RF output jack of the video disc player to the digital input jack.
- The digital signal jacks on this unit conform to the EIA standard. If you use a cable that does not conform to this standard, this unit may not function properly.
- Each type of audio jack works independently. Signals input through the digital and analog jacks are output through the corresponding digital and analog jacks, respectively.

## Connections

### VIDEO COMPONENTS

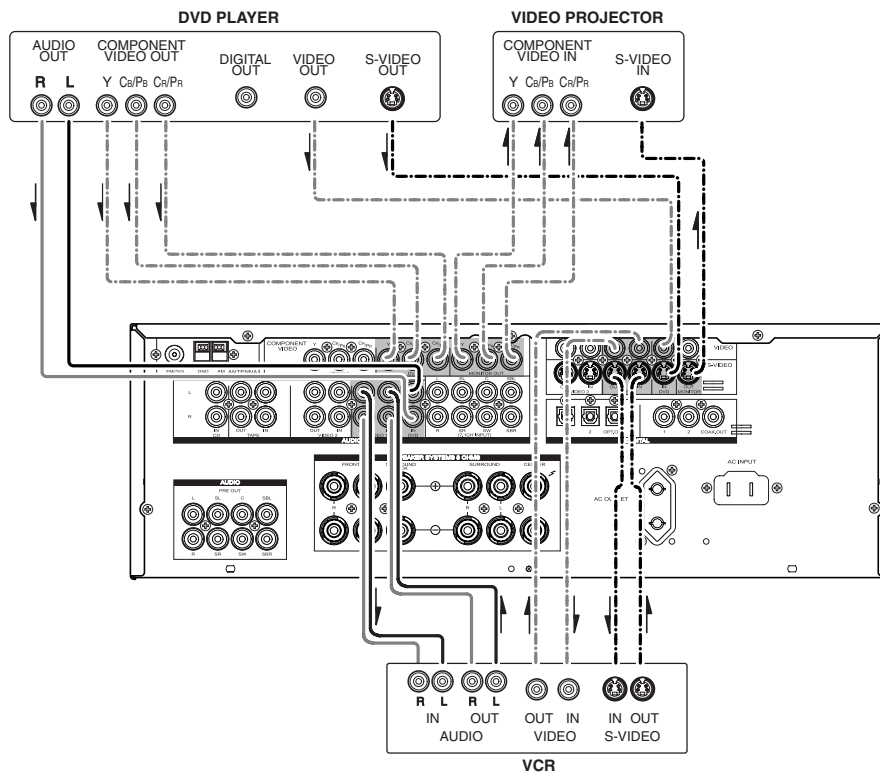

#### VIDEO, S-VIDEO , COMPONENT JACKS

There are 3 types of video jacks on the rear panel.

##### VIDEO jack

The video signal for the VIDEO jacks is the conventional composite video signal.

##### S-VIDEO jack

The video signal is separated into luminance (Y) and color (C) signals for the S-VIDEO jack. The S-VIDEO signals enables high-quality color reproduction. If your video component has an S-VIDEO output, we recommend to use it. Connect the S-VIDEO output jack on your video component to the S-VIDEO input jack on this unit.

##### Component jack

Make component video connections to a TV or monitor with component inputs to produce higher quality video images. Use a component video cable or 3 video cords to connect the component video out jacks on the LR-6500 to the monitor.

##### Video convert

The input signals S-video are converted video signals can be output.

Priority is given to S-VIDEO jack when having input by VIDEO and S-VIDEO jack from the same source.

#### Notes:

- Be sure to connect the left and right audio channels properly. Red connectors are for the R (right) channel, and white connectors are the for L (left) channel.
- Be sure to connect the inputs and outputs of the video signals properly.
- If you connect the S-VIDEO or component signal to the S-VIDEO or component jack on this unit, it is not necessary to connect the conventional video signal to the VIDEO (composite) jack. If you use both video inputs, this unit gives priority to the S-VIDEO signal.
- Each type of video jack works independently. Signals input to the VIDEO (composite) and S-VIDEO jacks or component are output to the corresponding VIDEO (composite) and S-VIDEO or component jacks, respectively.
- You may need to setup the digital audio output format of your DVD player, or other digital source components. Refer to the instructions of the each component connected to the digital input jacks.
- There is no Dolby Digital RF input jack. Please use an external RF demodulator with a Dolby Digital decoder to connect a video disc player which has a Dolby Digital RF output jack to the digital input jack on this unit.

## Connections

### VIDEO COMPONENTS AND ADVANCED CONNECTING

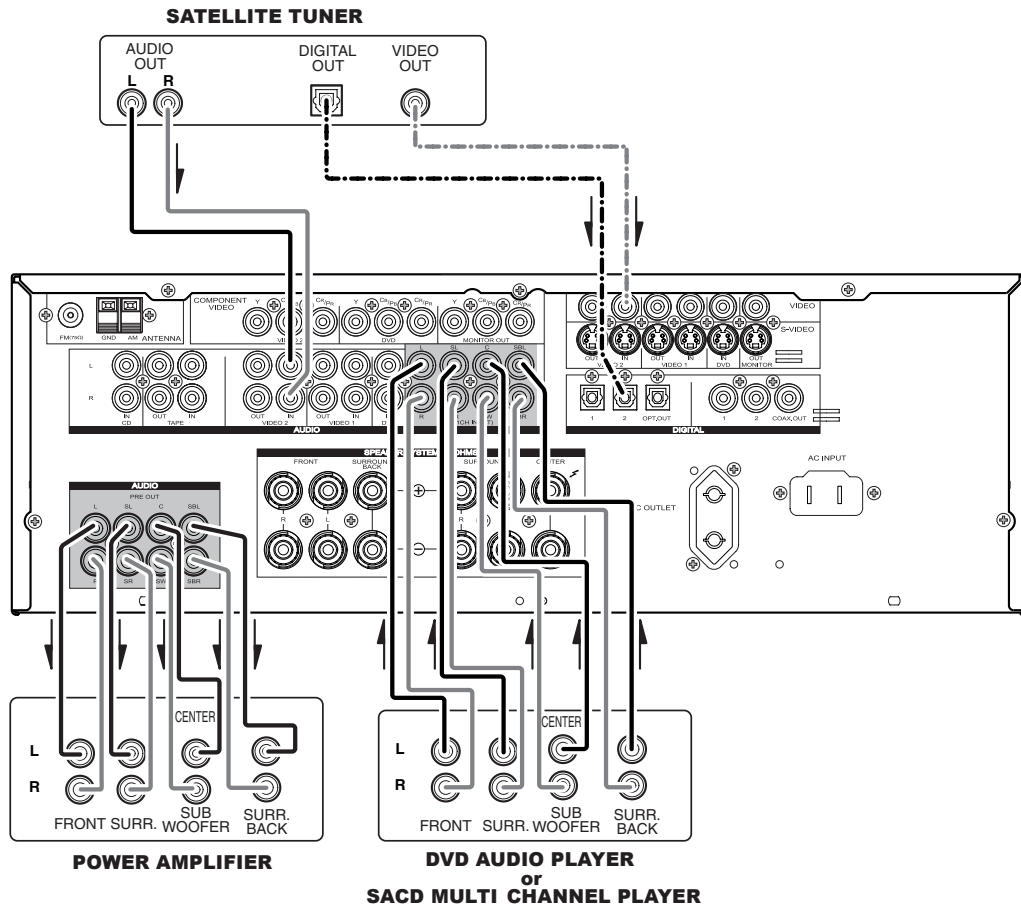

#### CONNECTING MULTI CHANNEL AUDIO SOURCE

The 7.1 CH DIRECT INPUT jacks are for multichannel audio source such as a SACD multichannel player, DVD audio player or external decoder.

If you use these jacks, switch on the 7.1 CH DIRECT INPUT and set the 7.1 CH DIRECT INPUT level by using the 7.1 channel input level menu.

#### CONNECTING AN EXTERNAL POWER AMPLIFIER

The PREOUT jacks are for connecting external power amplifiers.

Be sure to connect each speaker to the corresponding external power amplifier.

## Connections

### CONNECTING THE ANTENNA TERMINALS

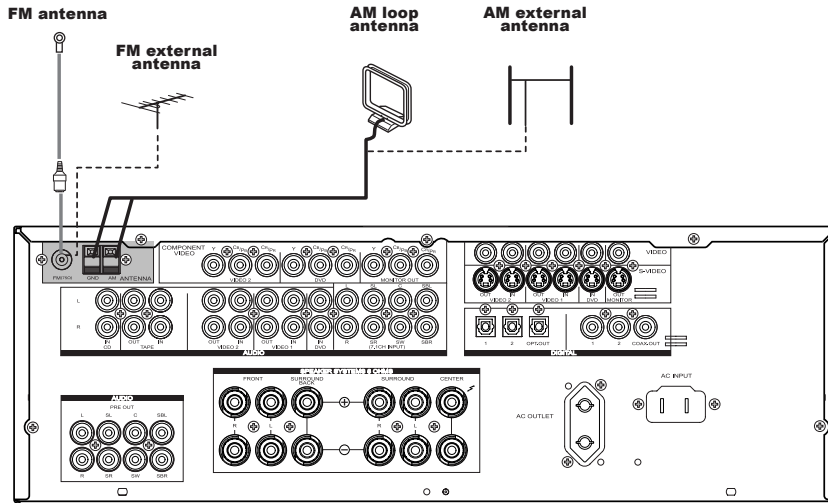

#### ASSEMBLING THE AM LOOP ANTENNA

1. Release the vinyl tie and take out the connection line.

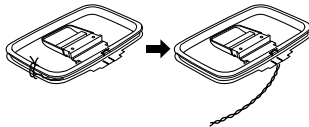

2. Bend the base part in the reverse direction.

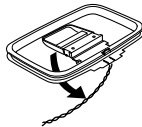

3. Insert the hook at the bottom of the loop part into the slot at the base part.

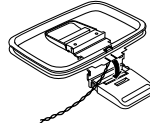

4. Place the antenna on stable surface.

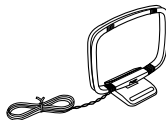

#### CONNECTING THE SUPPLIED ANTENNAS

##### Connecting the supplied FM antenna

The supplied FM antenna is for indoor use only. During use, extend the antenna and move it in various directions until the clearest signal is received. Fix it with push pins or similar implements in the position that will cause the least amount of distortion. If you experience poor reception quality, an outdoor antenna may improve the quality.

##### Connecting the supplied AM loop antenna

The supplied AM loop antenna is for indoor use only. Set it in the direction and position it to where you receive the clearest sound. Put it as far away as possible from the unit, televisions, speaker cables, and power cords. If you experience poor reception quality, an outdoor antenna may improve the quality.

1. Press and hold down the lever of the AM antenna terminal.
2. Insert the bare wire into the antenna terminal.
3. Release the lever.

#### CONNECTING AN FM OUTDOOR ANTENNA

##### Notes:

- Keep the antenna away from noise sources (neon signs, busy roads, etc.).
- Do not put the antenna close to power lines. Keep it well away from power lines, transformers, etc.
- To avoid the risk of lightning and electrical shock, grounding is necessary.

#### CONNECTING AN AM OUTDOOR ANTENNA

An outdoor antenna will be more effective if it is stretched horizontally above a window or outside.

##### Notes:

- Do not remove the AM loop antenna.
- To avoid the risk of lightning and electrical shock, grounding is necessary.

## Control Functions

### Front Panel

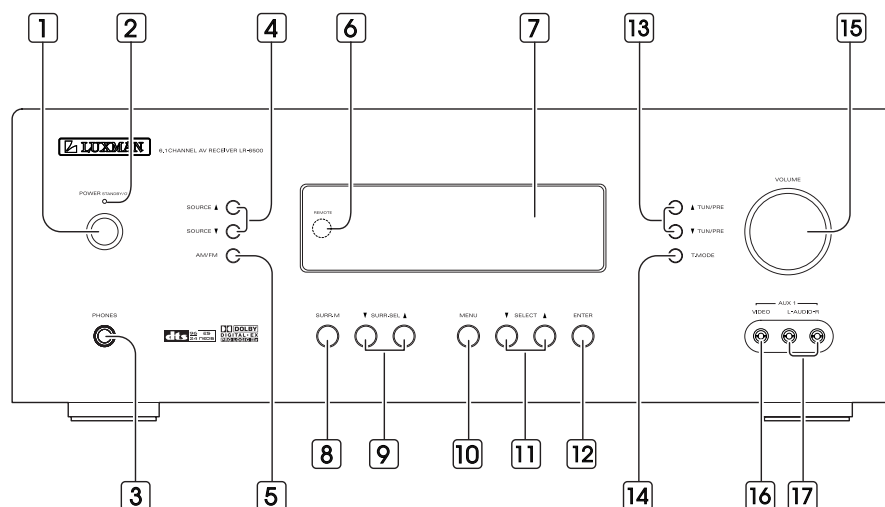

#### 1 Main Power Switch

Press this button to turn the unit standby or off.

#### 2 Power Indicator

This LED Lights amber when the unit is in the standby mode to signal that the unit is ready to be turn on, when the unit is in operation, the indicator is blue.

#### 3 PHONES

This jack may be used to listen to the LR-6500's output through a pair of headphones.

The speakers will automatically be turned off when the headphone jack is in use.

#### 4 SOURCE (▲/▼)

Use these to select inputs. Also, these buttons used power on switch when main power switch "ON" press these buttons to turn on the unit.

#### 5 AM/FM

Use this to switch between AM and FM bands.

#### 6 Remote Sensor

When operating the remote control unit, point it toward the remote sensor.

#### 7 Display

When the unit on, the current status of the unit is displayed.

#### 8 Surround Mode Group selector

Press this button to select the top-level group of surround modes.

Each press of the button will select the current or last used mode in each of the surround mode.

#### 9 Surround Mode selector (▼/▲)

Press these buttons to select from among the avail-

able surround mode options for the mode group and if the input source is digital or analog.

#### 10 MENU

Press repeatedly to select TONE MODE, CHANNEL Level, Digital Input, Speaker Setup, Distance Adjust.

#### 11 SELECT (▼/▲)

When configuring the MENU settings, use these buttons to select from available choice.

#### 12 ENTER

When marking choices during the setup and configuration process, press this button to enter the desired setting.

#### 13 TUN/PRE (▲/▼)

In Tuner mode, use these to tune in station.

#### 14 T.MODE

Press this button to select Auto or Manual tuning.

#### 15 VOLUME

Turn this knob to adjust the master volume.

#### 16 VIDEO Input Jacks

These jacks may be used for temporary connection to the composite of video games, camcorders or other portable video products. You may make a connection to either jack at any time, but not to both simultaneously.

#### 17 AUDIO Input Jacks

These audio jacks may be used for temporary connection to video games or portable audio players.

## Control Functions

### Display

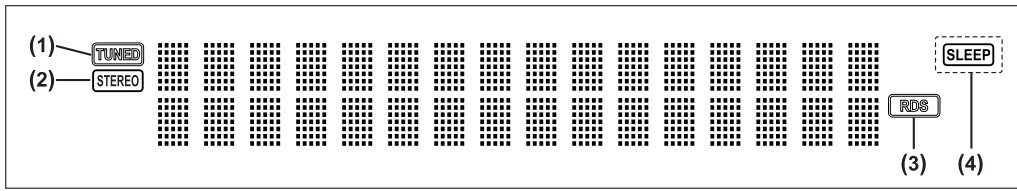

### Remote Control Unit

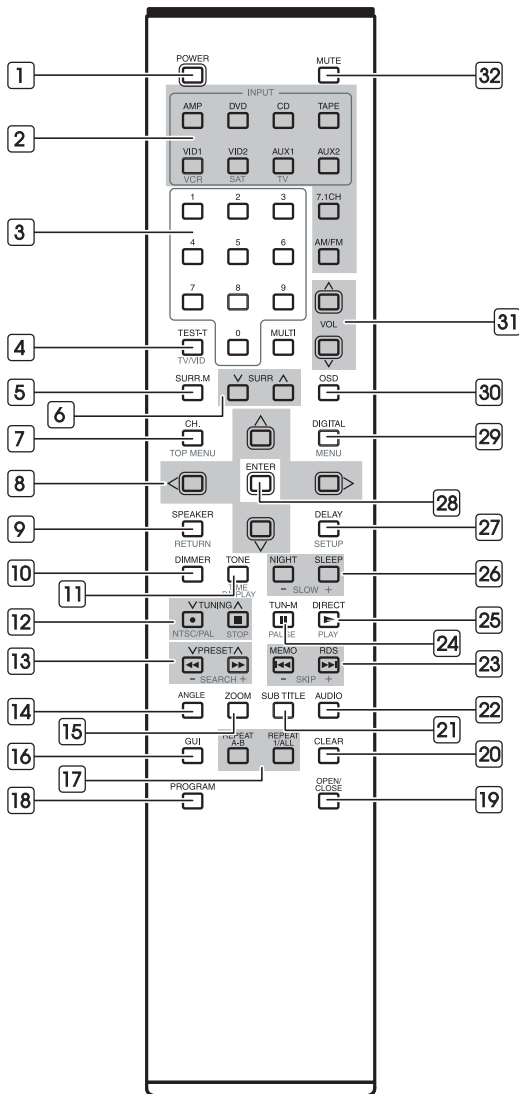

- 1** Illuminates when a station is tuned.
- 2** STEREO indicates in the tuner mode.
- 3** RDS MODE indicator
- 4** SLEEP indicator  
Lights up when the sleep timer is active.

- 1** POWER  
System power on and off.
- 2** FUNCTION buttons  
Use these buttons to select function modes.
- 3** Numeric buttons  
These buttons serve as a 10 button numeric keypad to enter tuner preset positions.
- 4** TEST-T  
- Output test tone for setting speaker levels.  
**TV / VID**  
- This button does not have a direct function on the LR-6500, but when used with a compatibly programmed VCR, DVD or satellite receiver that has a "TV / VIDEO" function, pressing this button will switch between the output of the player or receiver and the external video input to that player.  
Consult the owner's manual for your specific player or receiver for the details of how it implements this function.
- 5** SURR. M  
Press repeatedly to select the top-level group of surround modes.

## Control Functions

### 6 SURR (v/∧)

Press this button to select from among the available surround mode options for the mode group selected.

### 7 CH.

- Press to select CHANNEL LEVEL. (AMP only)

### TOP MENU

- Press to call up the top menu. (DVD only)

### 8 DIRECTION

- Use to more through the options on menu screens.

### 9 SPEAKER

- Press this button to begin to process of configuring this unit's bass management system for use with the type of speakers used in your system.

### RETURN

- Use to go one menu back(current setting are maintained). (DVD only)

### 10 DIMMER

Press to adjust the brightness of the front display.

### 11 TONE

- This button used Bass/Treble control.

### TIME DISPLAY

- Use this button to display time information about the currently playing disc. (DVD only)

### 12 TUNING UP/DOWN

- When the tuner is in use, these buttons will tune up or down through the selected frequency band.

#### ● Record

- Press to start normal recording. (DVD only)

### NTSC/PAL

- Use this button to select NTSC, PAL or MULTI to match your TV standard. (DVD only)

#### ■ STOP

- Press to stop playback. (DVD only)

### 13 PRESET UP/ DOWN

- Press to select a tuner preset channel.

### SEARCH(◀◀/▶▶)

- During playback, these buttons are used for fast forward and fast reverse. (DVD only)

### 14 ANGLE

Selects a DVD camera angle if available. (DVD only)

### 15 ZOOM

Enlarges the DVD Audio image. (DVD only)

### 16 GUI

Brings up the ON-SCREEN display. (DVD only)

### 17 REPEAT

#### A-B

- To repeat a specific section on a disc. (DVD only)

#### 1/ALL

- To repeat chapter, track, title, disc(s). (DVD only)

### 18 PROGRAM

Press to programming DVDs, CDs, Video CDs and MP3. (DVD only)

### 19 OPEN / CLOSE

Opens or close the disc tray. (DVD only)

### 20 CLEAR

Removes a track number on the program menu. (DVD only)

### 21 SUB TITLE

Select a subtitle language. (DVD only)

### 22 AUDIO

Selects different audio languages available in the DVD disc. (DVD only)

### 23 MEMO

- In Tuner mode to program preset radio stations.

#### RDS

- This function is used display information that is broadcasted by FM stations.

#### SKIP (◀◀/▶▶)

- When playing discs, press ◀◀ to go back to the beginning of the current chapter / track and ▶▶ to advance to the next chapter / track. (DVD only)

### 24 TUN-M

- Switches from tuning to (manual or auto) tuning mode.

#### PAUSE(II)

- Press to pause playback of a disc. (DVD only)

### 25 DIRECT

- Press this button when the tuner is in use to start the sequence for direct entry of a station's frequency.

#### PLAY (▶)

- Press to start or resume playback. (DVD only)

### 26 NIGHT

- Press this button to activate the night mode. This mode is available in specially encoded digital sources, and it preserves dialogue(center channel) intelligibility at low volume levels.

#### SLEEP

- Press to set the sleep timer.

#### SLOW(-, +)

- Press to watch a disc with a slower speed. (DVD only)

## Control Functions

### 27 DELAY

- Press this button to begin the process for setting the delay times used LR-6500 when processing surround sound or to compensate for video-to-audio delays caused by the use of digital sources or video displays.

### SET UP

- Enter or exit the system setup menu. (DVD only)

### 28 ENTER

Press to enter setting.

### 29 DIGITAL

- Press this button to assign one of the digital inputs to a source

### MENU

- Access the menu on a DVD disc. (DVD only)

### 30 OSD

- Press this button to activate the ON-Screen Display(OSD) system used to set up.
- Select to NTSC or PAL (press this button for more than 3 seconds).

### 31 VOL (^/v)

Press to adjust volume.

### 32 MUTE

Press to activate the mute function.

## Basic Operations 1

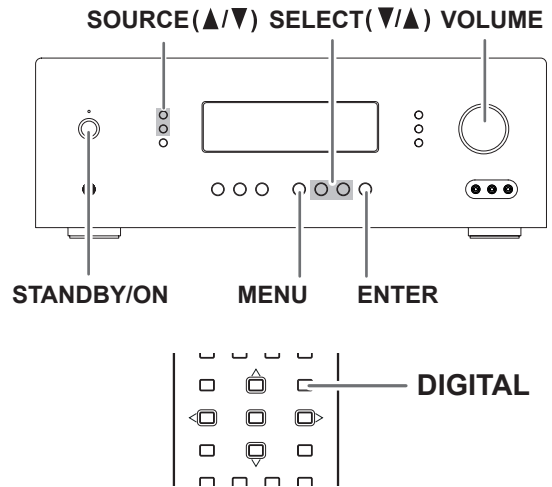

**1** Press the **STANDBY/ON** button.

**2** Select a source by pressing the **SOURCE (▲/▼)** button repeatedly.

DVD  
CD  
TUNER  
TAPE  
7.1 CH DIRECT IN  
VIDEO 1  
VIDEO 2  
AUX 1

**3** Press **DIGITAL** button and press the **▲** or **▼** button repeatedly to select one of the digital inputs or the analog input for any source.

or

1. Press the MENU button on the front panel.
2. Each time the SELECT(▲or▼) button is pressed until "DIGITAL INPUT" displayed on the front panel.
3. Press the ENTER button.
4. Each time the SELECT(▲or▼) button is pressed to select you desired input.

**4** Play the source, and gradually turn up the volume to the required level with the **VOLUME** control.

**3**

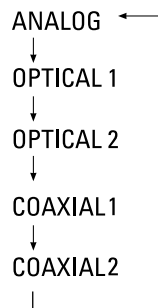



## Basic Operations 2

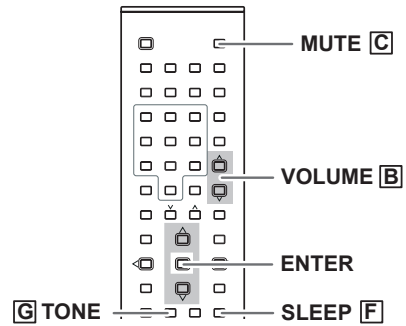
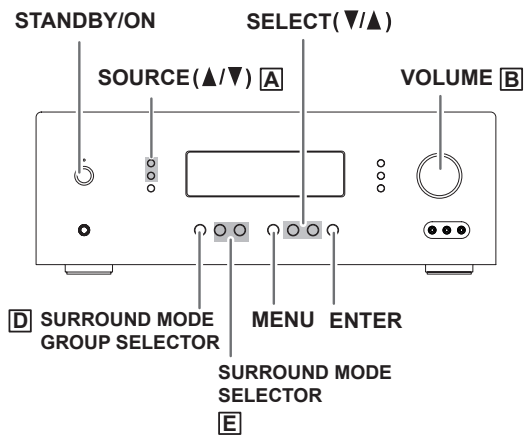

### A SOURCE (▲/▼)

Press to select input sources.

### B VOLUME knob

To control the overall listening level, turn the MASTER VOLUME knob or press the VOLUME buttons (+/-) on the remote control unit.

### C MUTE

To mute the sound temporarily, press the MUTE button. Press the MUTE button again to restore the sound. If you change the volume during the muting, the muting will be canceled.

While muting is engaged, the MUTE indicator will flicker.

### D Surround Mode Group Selector

Press this button to select the top-level group of surround modes.

Each press of the button will select the current or last used mode in each of the surround mode groups.

### E Surround Mode Selector

Press this button to select from among the available surround mode options for the mode group selected.

### F Sleep Timer Function

This function allows you to preprogram the receiver to switch its own power off automatically. You can then enjoy the audio/video system for a specified amount of time without having to worry about turning the unit off later.

Each press of the SLEEP button changes the time indication by 10 minutes.

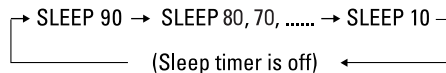

To let the remaining time (until power off) appear on the display while the sleep timer is engaged, press the SLEEP button once.

### G TONE Control

1 Press the TONE button or press the MENU button and ENTER button on the front panel in serial order.

"TONE IN" appears on the front panel's display.

2 Press the ENTER button.

"BASS ADJUST" appears on display.

3 Press the ▲/▼ button to select "BASS ADJUST" or "TREBLE ADJUST" or press the SELECT(▼/▲) button and press the ENTER button on the front panel.

- To adjust the level of low frequency sound range, select "BASS ADJUST".

- To adjust the level of high frequency sound range, select "TREBLE ADJUST"

4 Press the ▲/▼ buttons of remote control unit or the SELECT(▼/▲) button to change the setting. The level can be adjusted in 1 dB steps from -10 to +10.

## Surround Mode

One of the most important features of the LR-6500 is its ability to reproduce a full multichannel surround sound field from digital sources, analog matrix surround-encoded programs and standard stereo programs. Surround modes may be changed at any time by using either the front panel or remote controller.

**1** Press the SURR.M button (or the SURR.M button on the remote controller) from the front panel until the desired major surround mode group such as Dolby or DTS is selected to select a new surround mode.

**2** Press the SURR. SEL(▼/▲) button (or the SURR(v/∧) on the remote controller) repeatedly until choose the specific individual.

- The Dolby Digital, Dolby Digital EX and DTS 5.1, DTS-ES Matrix and DTS-ES Discrete modes may only be selected when a digital input is in use.

- The Dolby Pro Logic IIx modes are available only when the LR-6500 has been configured for 6.1/7.1 operation by configuring the Surround Back speakers as either "Large" or "Small"

- When the 7.1 CH direct inputs are in use there is no surround processing, as these inputs take the analog output signals from an optional, external DVD-Audio or SACD player, or another source device and carry them straight through to the volume control without any further digital processing.

- To listen to a program in traditional two-channel stereo, using the front left and front right speakers only (plus the subwoofer, if installed and configured).

NOTE: Once a program has been encoded with matrix surround information, it retains the surround information as long as the program is broadcast in stereo. Thus, movies with surround sound may be decoded via any of the analog surround modes such as Dolby Pro Logic II Movie or DTS Neo:6 Cinema, when they are broadcast via conventional TV stations, cable, pay-TV and satellite transmission. In addition, a growing number of made-for-television programs, sports broadcasts, radio dramas and music CDs are also recorded in surround sound.

## Night Mode

In many listening situations, you may find loud passages objectionable. Adjusting this setting allows you to compress the sounds into a range that you may find more suitable for a particular listening situation. Dolby Digital satisfies these needs through the dynamic range controlling. Select one of the followings to fit the individual listening situation of the audience.

**1** The Night mode may be engaged when a Dolby Digital DVD is playing by pressing the NIGHT button.

**2** Press the ▲/▼ buttons to select either the middle range of full-compression versions of the Night mode.

MAX:

Audio with fully compressed dynamic range.

MID:

Audio with partially compressed dynamic range.

OFF:

Audio with uncompressed dynamic range. Select this when you don't want to use the night mode.

- This function is effective only when playing back a DVD disc recorded with Dolby Digital. This control has no effect on other discs.

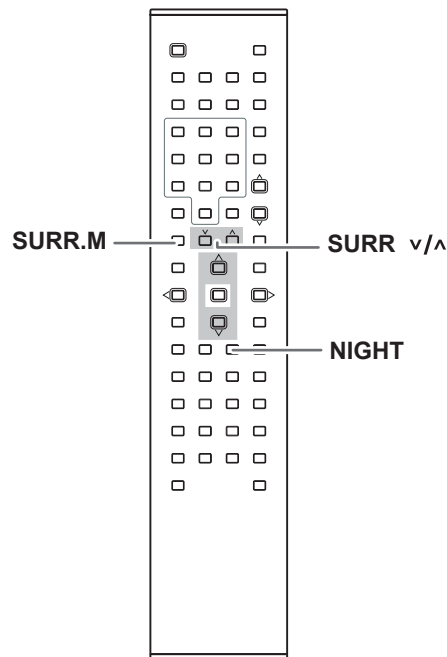

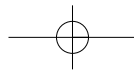

# Speaker Configuration

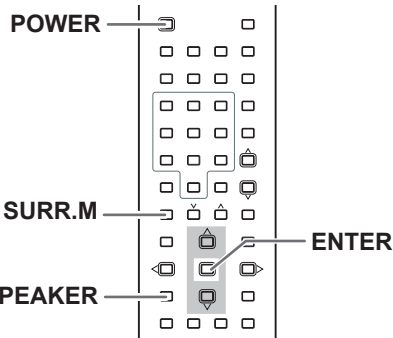
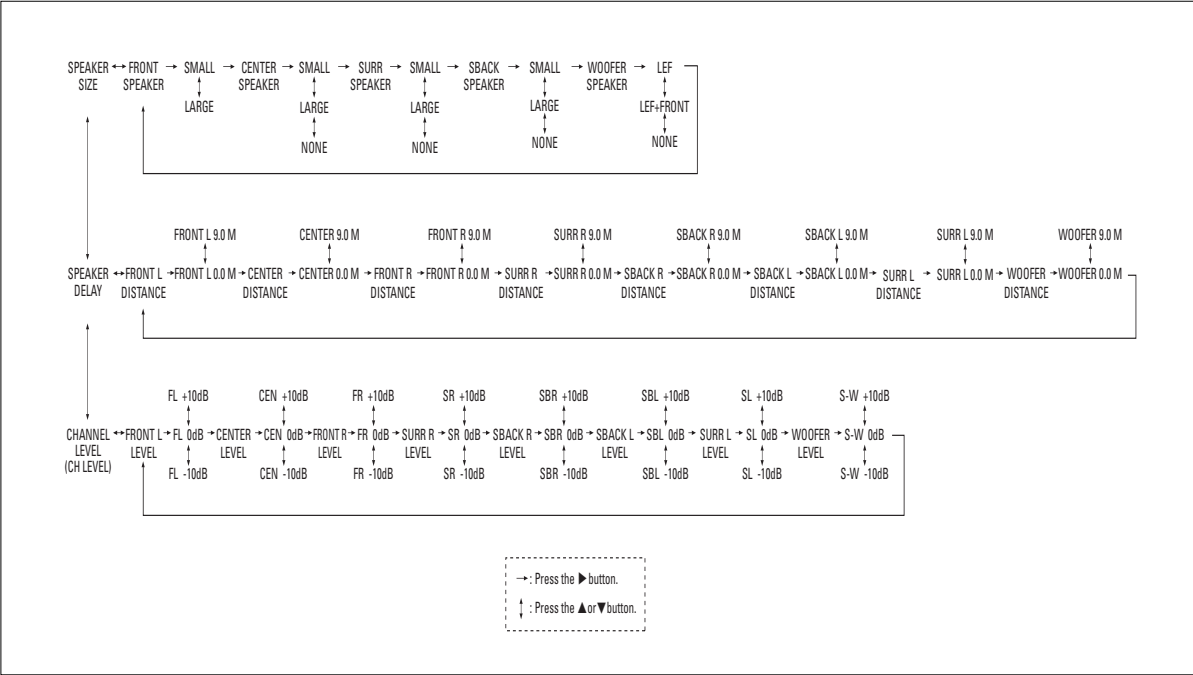

round mode for 7.1 channel (such as **DOLBY PRO LOGIC IIx MUSIC** or **MOVIE**, etc).

- 3** Press the **SPEAKER** button.  
"FRONT SPEAKER" appears on the front panel's display.
- 4** Press the **ENTER** button.  
"FRONT LARGE" or "FRONT SMALL" appears on the display.
- 5** Press the **▲/▼** buttons to change the setting.
- 6** Press the **ENTER** button.  
The setting is saved in memory.
- 8** Press the **▲** button.  
The next configuration (CENTER) appears on the display.

It is important to perform speaker configuration prior to using the surround sound decoder.

This allows the unit to sense the available speakers and automatically select decoding modes. It is possible to receive multi-channel surround sound without a center speaker, but for best results with Dolby Pro Logic IIx and Dolby Digital decoding, at least 5 speakers (Left, Center, Right, Left Rear and Right Rear) should be used.

- When no action is taken for 10 seconds, the Speaker Setup mode will be cancelled.

## Size of Speakers

- 1** Press the **POWER** button to turn the unit on.
- 2** Press the **SURR.M** button and select another sur-

Repeat step **4** to **8** to set other configurations. When all the configurations have been finished, press the **SPEAKER** button (or leave the unit for 5 seconds) to exit the Speaker Setup mode.

## Speaker Configuration

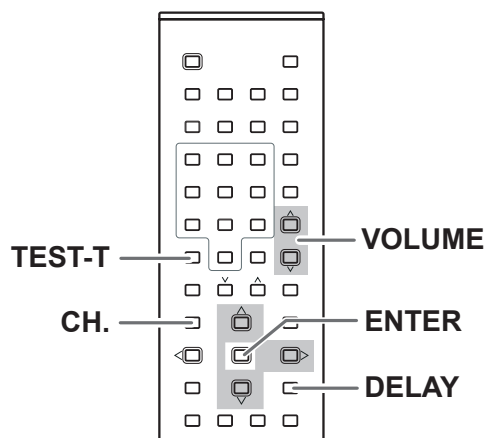

### Input the distance from your listening position

**1** Press the **DELAY** button to "FRONT L DISTANCE" appears on the front panel's display.

**2** Press the **ENTER** button.

"FRONT" appears on the display.

**3** Press the **▶** button.

"FRONT L 3.0 M" appears on the display.

**4** Press the **▲/▼** buttons to change the setting.

Input the distance from your listening position to front speakers.

You can change the setting from 0.0 to 9.0 M.

**5** Press the **ENTER** button.

**6** Press the **▲** button.

The next configuration (CENTER DISTANCE) appears on the display.

Repeat step **2** to **6** to change the setting for center and surround speakers.

When all the configurations have been finished, press the **DELAY** button (or leave the unit for 8 seconds) to exit the Delay Adjust mode.

### Balancing relative volume between speakers using Test Tone

The test tone function is useful to adjust the relative volume between speakers.

Once the balance is set, you don't have to change the balance as long as the speakers aren't moved.

**1** Press the **TEST-T** button.

The test tone is emitted from each speaker in the following order at 2-second intervals.

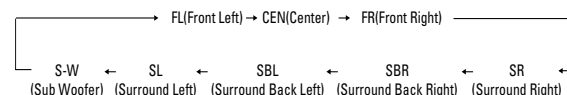

**2** Adjust the volume to the normal listening level.

**3** Adjust the volume of each speakers so that the test tone from each speakers sounds the same.

The level of the speaker which is emitting the test tone can be changed by pressing the **▲/▼** buttons.

- The level can be adjusted in 1 dB steps from -10 dB to +10 dB.

**4** When the setting has been finished, press the **TEST-T** button to stop the test tone.

### Output Level Adjustment (Balancing relative volume between speakers)

**1** Press the **CH.** button.

"FRONT L LEVEL" (Level of Front Left) appears on the display.

**2** Press the **ENTER** button.

"FL LEVEL 0 dB" appears on the display.

**3** Press the **▲/▼** buttons to change the setting.

The level can be adjusted in 1 dB steps from -10 dB to +10 dB.

**4** Press the **ENTER** and press the **▲** button.

The next configuration (CENTER LEVEL) appears on the display.

Repeat step **2** to **4** to change other settings.

When all the configurations have been finished, press the **CH.** button (or leave the unit for 10 seconds) to exit the CH Level Adjust mode.

## Tuner Operation

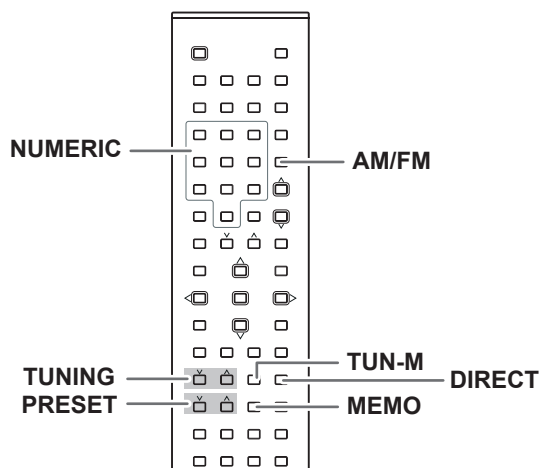
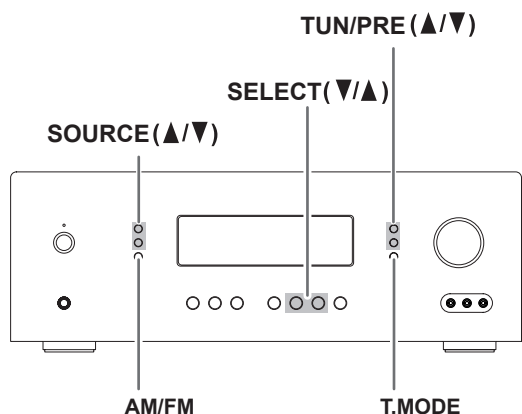

The LR-6500's tuner is capable of tuning AM, FM and FM Stereo broadcast stations. Stations may be tuned manually, or they may be stored as favorite station presets and recalled from a 50-position memory.

### Station Selection

**1** Press the AM/FM button on the remote controller to select the tuner as an input

or

The tuner may be selected from the front panel by either pressing the SOURCE (▲/▼) buttons until the tuner is active or by pressing the AM/FM button.

**2** Pressing the AM/FM button or the AM/FM button on the front panel again to switch between AM and FM so that the desired frequency band is selected.

**3** Press the T.MODE on the front panel (or the TUN-M button on the remote controller) to select manual or automatic tuning.

**4** Select "AUTO TUNING" and each press of the TUNING(v/^) button (or TUN/PRE button). Then put the tuner in a scan mode that seek the next higher or lower frequency station with acceptable signal strength.

- Select "MAUNAL TUNING" and each press of the TUNING(v/^) button (or TUN/PRE button). The frequency increases or decreases by one increment.

**5** Stations may also be tuned directly. To enter a station's frequency directly, first select the AM or FM. Next, press the DIRECT button on the remote controller and enter the station frequency by pressing the Numeric buttons.

### Tuner-Mode

Pressing the TUN-M button on the remote controller alternates between Stereo mode and Mono mode.

#### - STEREO

FM stereo broadcasts are received in stereo and the STEREO indicator lights in the display.

#### - MONO

To compensate for weak FM stereo reception, select this mode. Reception will now be forced monaural, reducing unwanted noise.

### Preset Memory

You can preset a maximum of 50 favorite channels.

**1** Press the MEMO button. The two underscore lines will appear at the far right side of the display.

**2** Within 5 seconds, press the Numeric buttons corresponding to the location where you wish to store this station's frequency.

**3** Repeat the process after tuning any additional stations to be preset.

#### Recalling Preset Stations

- To manually select a station previously entered in the preset memory, press the Numeric buttons that correspond to the desired station's memory location.

- To manually tune through the list of stored preset stations one by one, press the PRESET(v/^) button or the remote controller or the TUN/PRE (▲/▼) button on the front panel.

## RDS (Radio Data System) (Remote Controller Only)

RDS is a broadcasting service which allows stations to send additional information along with the regular radio program signal. RDS can be received only in FM band. Every time the RDS button is pressed, the mode is changed as follows:

### PS (Program Service Name)

When you select PS, "PS" is displayed, and in 4 seconds, the program service name will be displayed. If there is no PS data in the station, the frequency will be displayed.

### PTY (Program Type)

When you select PTY with the RDS MODE button, "PTY" will blink for about 4 seconds. After 4 seconds, the type of received PTY will be displayed.

### CT (Clock Time)

When you select CT with the RDS MODE button, "CT" will blink for about 4 seconds. After 4 seconds, the clock time will be displayed.

### RT

When you select RT with the RDS button, "RT" will blink for about 4 second. After 4 seconds, the data of received RT will be displayed. If there is no RT data among received broadcasting, RDS mode will be automatically switched to PS mode.

## PTY

### PTY search

A station can be searched by this function.

#### 1 Press the RDS button for more than 1.5 seconds.

Then "PTY SEARCH" will be shown in the display.

#### 2 Press the PRESET UP/DOWN button to select to desired PTY mode. (The program will blink.)

#### 3 Press the TUNING button. (PTY search be ready)

When the PTY mode that you have selected is searched, PTY search will stop and the PTY mode will be displayed. If the same program type is not found during PTY Search, it will stop at the beginning frequency. If you want to cancel PTY search while searching, press the RDS button. PTY search will stop and search mode will be released automatically.

## RDS (PTY)

NEWS	:brief announcements, events, public opinion, reports, actual situations.
AFFAIRS	:a kind of suggestion including practical announcements other than news, documents, discussion, analysis and so on.
INFO	:daily information or reference such as weather forecast, consumer guide, medical assistance and so on.
SPORT	:sports related programs.
EDUCATE	:educational and cultural information.
DRAMA	:all kinds of radio concert and serial drama.
CULTURE	:all aspects of national or local culture including religious events, philosophy, social science, language, theatre, and so on.
SCIENCE	:programs on natural science and technology
VARIED	:popular programs such as quiz, entertainment, private interview, comedy, satire and so on.
POP M	:program on commercial, practical and popular songs, and sale volume of discs, etc.
ROCK M	:practical modern music generally composed and played by young musicians.
EASY M	:popular music usually lasting for less than 5 minutes.
LIGHT M	:classical music, instrumental music, chorus, and light music favored by non-professionals.
CLASSICS	:orchestra including great operas, symphony, chamber music and so on.
OTHER M	:other music styles(Rhythm & Blues, Reggae, etc.)
WEATHER	:weather reports, forecast
FINANCE	:financial reports, commerce, trading
CHILDREN	:children's programs
SOCIAL	:social affairs
RELIGION	:religious programs
PHONE IN	:program in which the public expresses its view by phone.
TRAVEL	:travel reports
LEISURE	:programs concerning recreational activities
JAZZ	:jazz music
COUNTRY	:country music
NATION	:national music
OLDIES	:music from the so-called golden of popular music
FOLK M	:folk music
DOCUMENT	:documentaries
TEST	
ALARM !	:a program notifying an emergency or a natural disaster.

## Video Operations

### Playing Video Sources

**Note:**

When playing videos that feature surround sound, refer to "Available Surround Modes".

- 1 Select the DVD, VIDEO 1, VIDEO 2, AUX 1 mode by pressing the SOURCE(▲/▼) button
- 2 Play the component corresponding to the FUNCTION selected.
- 3 The picture from the video source can be seen on the TV and the sound from the video source will be heard from the speakers.

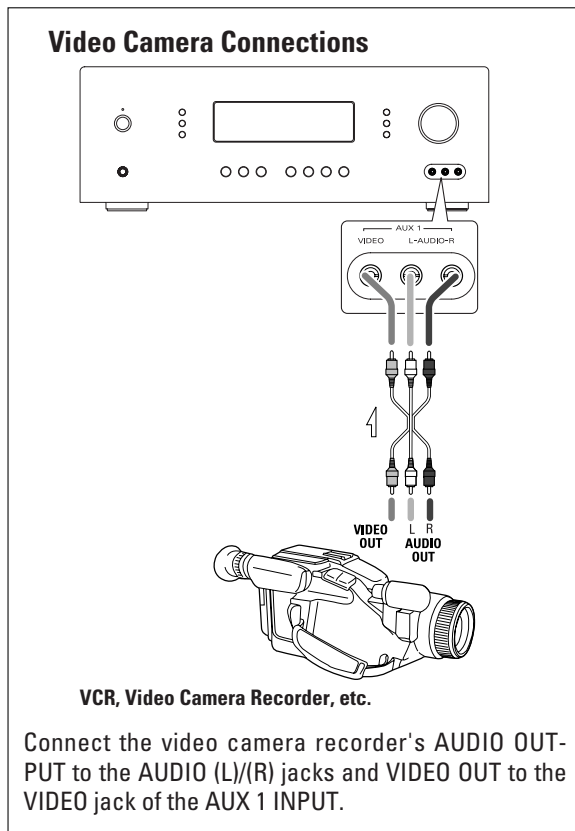

### Video Tape Dubbing

- 1 Press the SOURCE(▲/▼) button to select the VIDEO source to be recorded.
- 2 Playback the source.
- 3 Operate VID 1 or VID 2/VCR for recording.

Video/audio signals from the selected VIDEO source can be dubbed to VID 2/VCR only.

## System Configuration (OSD - On Screen Display)

Before using the unit, you will probably want to change the settings for most inputs so that they are properly configured to reflect the use of digital or analog inputs, the type of speakers installed and the surround mode specifics of your home theater system. Remember that since the LR-6500 memorizes the settings for each input individually, you will need to make these adjustments for each input used. However, once they are made, further adjustment is only required when system components are changed.

### Making Configuration Adjustments

- 1 If another function is selected, press the AMP button.
- 2 Press the OSD button.  
The MAIN MENU will appear, and adjustments are made from the individual menus. The menu will remain on the screen for 20 seconds.
- 3 Select an item you want to change using the ▲/▼ buttons.
- 4 Press the ENTER button.
- 5 Press the ► button repeatedly until the setting you want to select appears.

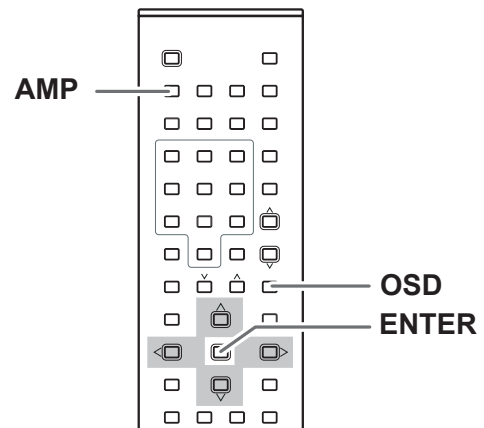

2

** MAIN MENU **	
▶ FUNCTION	SETUP
SURROUND	SETUP
SPEAKER	SETUP
DISTANCE	ADJUST
CH LEVEL	ADJUST
PREFERENCE	SETUP

## System Configuration

### A FUNCTION SETUP

```

* FUNCTION SETUP *
▶ INPUT FUNC :      DVD
  DIGITAL IN :      ANALOG
  DIGITAL POLLING : NO

BACK TO MAIN MENU
  
```

You can select associate one of the digital inputs with the selected input source. Some digital video input sources, such as a cable box or HDTV set-top, may change between analog and digital outputs, depending on which channel is in use. The LR-6500's Auto Polling feature allows you to avoid losing the audio feed when this happens by permitting both analog and digital connections to the same source on the unit. Digital audio is the default, and the unit will automatically switch to the analog audio if the digital audio stream stops.

### B SURROUND SETUP

```

* SURROUND SETUP *
▶ DOLBY SURROUND
  DTS
  DSP SURROUND
  STEREO

BACK TO MAIN MENU
  
```

#### Dolby Digital

Available only with digital input sources encoded with Dolby Digital data. It provides up to five separate main audio channels and a special dedicated low-frequency effects (LFE) channel.

#### Dolby Digital EX

Available when the receiver is configured for 6.1/7.1-channel operation, Dolby Digital EX is the latest version of Dolby Digital. When used with movies or other programs that have special encoding, Dolby Digital EX reproduces specially encoded soundtracks so that a full 6.1/7.1 sound field is available. When the receiver is set for 6.1/7.1 operation and a Dolby Digital signal is present, the EX mode is automatically selected. Even if specific EX encoding is not available to provide the additional channel, the special algorithms will derive a 6.1/7.1 output.

#### DTS 5.1

When the speaker configuration is set for 5.1-channel operation, the DTS 5.1 mode is available when DVD, audio-only music or laser discs encoded with DTS data are played. DTS 5.1 provides up to five separate main audio channels and a special dedicated low-frequency channel.

#### DTS-ES 6.1 Matrix, DTS-ES 6.1 Discrete

When the speaker configuration is set for 6.1/7.1 operation, playback of a DTS-encoded program source will automatically trigger the selection of one of the two DTS-ES modes. Newer discs with special DTS-ES discrete encoding will be decoded to provide six discrete, full-bandwidth channels plus a separate low-frequency channel. All other DTS discs will be decoded using the DTS-ES Matrix mode, which creates a 6.1-channel sound field from the original 5.1-channel soundtrack.

#### Dolby Pro Logic II (Movie, Music, Pro Logic)

Dolby Pro Logic II is the latest version of Dolby Laboratory's benchmark surround technology that decodes full-range, discrete left, center right, right surround and left surround channels from either matrix surround-encoded programs and conventional stereo sources when an analog input is in use. The Dolby Pro Logic II Movie mode is optimized for movie soundtracks, while the Pro Logic II Music mode should be used with musical selections. The Pro Logic mode activates original Pro Logic processing for those who prefer that presentation.

#### DTS Neo:6 Cinema, DTS Neo:6 Music

These two modes are available when any analog source is playing to create a six-channel surround presentation from conventional Matrix-encoded and traditional Stereo sources. Select the Cinema version of Neo:6 when a program with any type of analog Matrix surround encoding is present.

Select the Music version of Neo:6 for optimal processing when a nonencoded, two-channel stereo program is being played.

#### Theater

The Theater mode creates a sound field that resembles the acoustic feeling of a standard live-performance theater.

#### Hall 1, Hall 2

The two Hall modes create sound fields that resemble a small (Hall 1) and medium-sized (Hall 2) concert hall.



## System Configuration

### 5-Channel Stereo, 7-Channel Stereo

This mode takes advantage of multiple speakers to place a stereo signal at both the front and back of a room. Depending on whether the unit has been configured for either 5.1 or 6.1/7.1 operation, one of these modes, but not both, is available at any time. Ideal for playing music in situations such as a party, it places the same signal at the front-left and surround-left, and front-right and surround-right speakers.

The center channel is fed a summed mono mix of the in-phase material of the left and right channels.

### Stereo

This mode turns off all surround processing and presents the pure left- and right-channel presentation of two-channel stereo programs.

**PURE STEREO:** When Audio input is selected analog, the unit is in a "bypass" mode with no bass management.

**DSP STEREO:** When DSP Stereo is selected, the signal is digitized and bass management settings are applied.

### DOLBY SURROUND

When DOLBY SURROUND mode is selected, a menu will be shown.

```

* DOLBY SURR *
▶ MODE : DOLBY PRO LOGIC
  CENTER WIDTH : ----
  DIMENSION : ----
  PANORAMA : ----
  NIGHT : OFF
  UPSAMPLING : ----
  BACK TO MAIN MENU
  
```

The choices on this menu include the selection of the actual surround mode, the selection of rear channel post-processing when the system is configured for 7.1 operation, adjustments to the Night Mode when available with a Dolby Digital soundtrack, the adjustment of special parameters available when either Dolby Pro Logic II Music or Dolby Pro Logic IIx Music is selected as the surround mode and control over digital upsampling, when available.

• **Center Width:** This setting adjusts the balance of the vocal information in the front sound stage between the center and front left/right speakers. The lower settings spread the center channel sound more broadly into the left and right channels. A higher number (up to "7") produces a tighter center channel presentation.

• **Dimension:** This setting alters the perceived depth of the surround field by creating a shallower presentation that appears to move sounds toward the front of the room, or a deeper presentation that appears to move the center of the sound field toward the back of the room. The setting of "0" is a neutral default, with the range of adjustment shown as "R-3" for a deeper, rear-oriented sound.

• **Panorama:** Switch this setting on or off to add an enveloping wraparound presentation that increases the perception of sound along the sides of the room.

### • NIGHT

**OFF:** When OFF is highlighted, the Night mode will not function.

**MID:** When MID is highlighted, a mild compression will be applied.

**MAX:** When MAX is highlighted, a more severe compression algorithm will be applied.

### • UPSAMPLING

The setting to turn the unit's upsampling feature on or off. In normal use, this feature is turned off, which means that digital sources are processed at their native sample rate. For example, a 48kHz digital source will be processed at 48kHz. However, the LR-6500 allows you to upsample the incoming 48kHz signals to 96kHz for added resolution.

**NOTE:** This feature is only available for the Dolby Pro Logic II-Music, Dolby Pro Logic II-Movie, Dolby Pro Logic and Dolby 3 Stereo modes.

### SPEAKER SETUP

```

* SPEAKER SETUP *
▶ MODE      : SPEAKER SIZE
  LEFT/RIGHT : SMALL
  CENTER    : SMALL
  SURROUND  : SMALL
  SURR BACK : SMALL
  SUBWOOFER : SUB
  BACK TO MAIN MENU
  
```

This menu allows you to switch the menu to change either the speaker size setting or the exact crossover point used for that speaker group. For the first pass through the menu, leave the setting at its default option of SPEAKER SIZE, and then proceed as outlined below. Once the speaker choices have been set, you may wish to return to this line to change the option so that the crossover settings may be adjusted.

## System Configuration

### • SPEAKER SIZE MODE

#### LEFT/RIGHT

**LARGE:** Select this when large front speakers are connected. Front channel materials are sent to the front speakers at full range. When this setting is selected, less bass signal is sent to the sub-woofer. Only use this setting if you have adequate sized bass drivers in your front speakers.

**SMALL:** Select this when the front speakers are rather small. When "SMALL" is selected, SUBWOOFER is set to "SUB" automatically, and bass frequencies of the front channels are output from a subwoofer. So a powered subwoofer is indispensable for this setting.

#### CENTER

**LARGE:** Select this when a large center speaker is connected. Center channel is output at full range.

**SMALL:** Select this when the center speaker is rather small. Bass frequencies are output from a subwoofer.

**NONE:** Select this when no center speaker is connected. The center channel will be output from front speakers.

#### SURROUND

**LARGE:** Select this when an external power amplifier and large surround speakers are connected. Surround channels are output to the surround speakers at full range.

**SMALL:** Select this when the surround speakers are rather small. Bass frequencies are output from your powered subwoofer.

**NONE:** Select this when no surround speakers are connected.

#### SURR BACK

**LARGE:** Select if the surround back speakers are large sized.

**SMALL:** Select if the surround back speakers are small sized.

**NONE:** Select if the surround back speakers are not connected.

#### SUBWOOFER

**LFE:** Select if a subwoofer is connected to the LR-6500, you have the option to have the front left/right "main"speakers reproduce bass frequencies at all times, and have the subwoofer operate only when the LR-6500 is being used with a digital source that contains a dedicated Low-Frequency Effects, or LFE, soundtrack. This allows you to take advantage of the special bass created for certain movies.

**LFE+FRONT:** Select if a subwoofer is connected and you wish to use it for bass reproduction in conjunction with the main front left/right speakers, regardless of the type of program source of Surround mode you are listening.

**NONE:** Select if no subwoofer is connected to this unit. All bass information will be routed to the front left/right speakers.

### • SPEAKER CROSS OVER MODE

* SPEAKER SETUP *	
▶ MODE	: SPK CROSS OVER
LEFT/RIGHT	: 100Hz
CENTER	: 100Hz
SURROUND	: 100Hz
SURR BACK	: 100Hz
LFE	: LEFT/RIGHT
BACK TO MAIN MENU	

The factory default setting for all speaker positions is 100Hz. If that setting is acceptable for all channels, then no adjustments are needed and you may skip this section. However, should you wish to change one of the settings. The available choices at which point low-frequency information will be sent to the subwoofer, rather than to the main speaker channel, are 40Hz, 60Hz, 80Hz, 100Hz, 120Hz and 200Hz.

### ■ DISTANCE ADJUST

*DISTANCE ADJUST*			
▶ FL	: 3.0 M	SBR	: 3.0 M
CEN	: 3.0 M	SBL	: 3.0 M
FR	: 3.0 M	SL	: 3.0 M
SR	: 3.0 M	SUB	: 3.0 M
DELAY RESET : OFF			
UNIT : METER			
BACK TO MAIN MENU			

Due to the different distances between the listening position and each speaker position, the amount of time it takes for sound to reach your ears from each channel is different. You may compensate for this difference through the use of the delay settings to adjust the timing for the speaker placement and acoustic conditions in your listening room or home theater.

#### NOTE

Once the DELAY ADJUST menu is on-screen, note that default for distance settings is in meter. If your measurements are not in meter, change to feet at the UNIT line.

## System Configuration

### F CH LEVEL ADJUST

* CH LEVEL ADJUST *			
▶ FL	: 0dB	SBR	: 0dB
CEN	: 0dB	SBL	: 0dB
FR	: 0dB	SL	: 0dB
SR	: 0dB	SUB	: 0dB
LEVEL DEFAULT	: OFF		
TEST TONE SEQ	: AUTO		
TEST TONE	: OFF		
BACK TO MAIN MENU			

Channel level adjustment is a key part of the configuration of any surround sound product. It is particularly important for a digital receiver such as the LR-6500, as correct outputs ensure that you hear soundtracks with proper directionality and intensity.

Listeners are often confused about the operation of the surround channels. While some assume that sound should always be coming from each speaker, most of the time there will be little or no sound in the surround channels. This is because they are only used when a movie director or sound mixer specifically places sound there to create ambience or special effect, or to continue action from the front of the room to the rear. When the output levels are properly set, it is normal for surround speakers to operate only occasionally. Artificially increasing the volume to the rear speakers may destroy the illusion of an enveloping sound field that duplicates the way you hear sound in a movie theater or concert hall.

Before beginning the output level adjustment process, make certain that all speaker connections have been properly made. The system volume should be set to the level that you will use during a typical listening session

#### NOTE

You can adjust channel level by pressing the TEST TONE button on the remote control.

### G PREFERENCE SETUP

* PREFERENCE SETUP *	
▶ DISPLAY TIME OUT	: OFF
DISPLAY MODE	: FULL
VOLUME DEFAULT	: OFF
DEFAULT VOL SET	: -25dB
SEMI OSD TIME OUT	: 5
FULL OSD TIME OUT	: 20
DEFAULT SURR MODE	: ON
BACK TO MAIN MENU	

#### • DISPLAY TIME OUT

Select amount of time(3s~10s) that the display to fade out of front panel. Select OFF if you do not wish to the front panel displays fade out.

#### • DISPLAY MODE

FULL: Normal brightness.

HALF: Half the normal brightness level.

OFF: All of the front panel indicators will go dark.

#### • VOLUME DEFAULT

ON

OFF

#### • DEFAULT VOL SET

Set the desired turn-on volume. This setting may not be made with the regular volume controls.

#### • SEMI OSD TIME OUT

The semi-OSD system places one-line message at the video display screen whenever the volume, input source, surround mode, tuner frequency or any of the configuration settings are changed.

Set to change the length of time that the semi-OSD displays remain on the screen.

#### • FULL OSD TIME OUT

The full-OSD menu system is used to simplify the setup and adjustment of the LR-6500, using a series of on screen menus. Set to change the length of time that full-OSD displays remain on the screen.

#### • DEFAULT SURR MODE

ON: Select if you wish to leave the default so that the mode choice encoded in the disc is always used, no further action is needed. Simply leave the setting at the factory default of ON.

OFF: Select to set the unit so that it responds to the last surround mode used when a Dolby Digital or DTS source is playing.

## Controlling other Components Connected to the LR-6500

The LR-6500 is equipped with a powerful remote control not only receiver's functions, but also most popular brands of audio and video equipment, including CD players, cassette decks, TV sets, cable boxes, VCRs, satellite receivers and other home theater equipment.

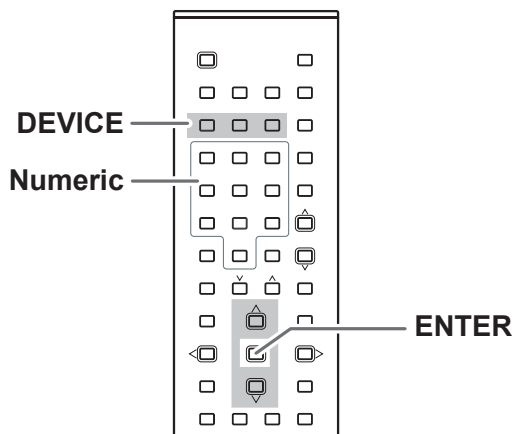

### Learning a Pre-programming Code

By following one of the methods below, you may program the remote to operate a wide range of devices from other manufacturers.

#### A Direct Code Entry Method

- 1 Find the 3-digit number for the brand name of the component that you want to operate in the code list following pages. (See 29 page.)
- 2 Turn on the component that you want to operate.
- 3 While holding down the DEVICE button on the remote controller that you want to program, press the ENTER button for 2 seconds, and then release both buttons.  
Then the SEND/LEARN indicator blinks twice.
- 4 Within 10 seconds, enter the 3-digit code number.  
(Correct input: SEND/LEARN indicator blinks fourth.  
Incorrect input: SEND/LEARN indicator blinks once.)
- 5 If the component does not operate properly, return to step 3 and repeat the steps above.

#### B Manual Search Method

- 1 Turn on the unit that you wish to include in the LR-6500 remote controller.
- 2 Press the DEVICE button (VCR, SAT, TV) and the ENTER button at the same time for 2 seconds until the SEND/LEARN indicator blinks twice.
- 3 Press the ▲ or ▼ button. Each press will send out a series of codes from the remote's built-in database.
- 4 When the unit being programmed turns off, press the ENTER button.  
(Correct input: SEND/LEARN indicator blinks fourth.  
Incorrect input: SEND/LEARN indicator blinks once.)

#### C Code Check Method

Check if enter the 3-digit code number directly.

- 1 While holding down the DEVICE button, press the ENTER button for 2 seconds and then release both buttons and then the SEND/LEARN indicator blinks twice.
- 2 Press the DIGITAL button.
- 3 The 3-digit code number blinks in order.  
Example: If you enter '105'  
1. 1: Indicator blinks once.  
2. 0: Indicator blinks tenth.  
3. 5: Indicator blinks fifth.

## Programming the Remote

### VCR Brand List

Brand	CODE No.					Brand	CODE No.				
AKAI	033	042	022	052	032	JENSEN	042				
ALBA	008	020				JVC	042	056	030	052	
AMSTRAD	011					KENWOOD	005	042			
ANITSCH	009					KRIESLER	045	031			
ARC EN CIEL	042	056	052			KUBA	043				
ARISTONA	045	031				LLOYD	011				
ASA	018					LOEWE OPTA	014	018	029	031	
AWIA	011	042				LOGIK	008	027			
BAIRD	042	033				LUXOR	033	038			
BAUER. BOSCH	014	043				MAGNADYNE	041				
BLAUPUNKT	014	043	055	031	054	MAGNASONIC	038				
	040					MAGNAVOX	019				
BRANDT						MARANTZ	004	014	046	018	031
ELECTRONIQUE	042	056	052			MATUI	010	025	027		
BRIONVEGA	041					MEMOREX	000	003	005	011	045
BUSH	008	020				METZ	014	043	031	054	037
C. EDISON	041					MGA	017				
CANON	014					MINERVA	055	054			
CAPEHART	020					MINOLTA	006	007			
CGE	011	042	052			MITSUBISHI	017	049			
CONTINENTAL						MTC	011	013			
EDISON	042	056	052			MULTITECH	008	011			
CRAIG	000	013				MURPHY	011				
CURTIS MATHES	019					NAONIS	042	056	052		
DAEWOO	001	020	021			NATIONAL	040				
DAYTRON	020					NEC	004	042	052		
DECCA	011	042				NECKERMANN	002	041	014	042	052
DEGRAAF	003	006	011	045	018	NOGAMATIC	042	056	052		
DUAL	042	052				NOKIA	003	005	041	042	056
DUMONT	003	011	018				050	052	033	038	
DYNATECH	011					NORDMENDE	039	042	056	052	053
EMERSON	002	010	011	019	025		035				
FERGUSON	042	036	030	052	034	OPTONICA	045	046			
FIDELITY	011					ORION	002	010	025	027	
FINLANDIA	003	018				OSAKI	011				
FINLUX	003	006	011	018		OTTO VERAND	043				
FISHER	000	003	005			P. CINEMA	014				
FUNAI	011					PALLADIUM	041	014			
GE	019					PANASONIC	023	051	040		
GENERAL	014					PATHE MARCONI	042	056	052		
GOLDSTAR	004					PENTAX	006	007			
GOODMANS	008	011	046			PERDIO	011				
GRAETZ	041	042	056	050	052	PHILIPS	012	014	045	046	018
	038						029	031			
GRANADA	003	005	018			PHONOLA	014	045	018	029	031
GRUNDIG	014	043	018	055	031	PORTLAND	020				
	053	054				PROLINE	011				
HANSEATIC	043					PYE	014	045	018	029	031
HARMAN-KARDON	004					QUARTZ	005				
HIFIVOX	042	056	052			QUELLE	002	044	054		
HINARI	002	008	024	027		RADIOLA	045	031			
HITACHI	006	007	011	042		RADIOMARELLI	041				
IMPERIAL	011					RCA	019				
INGELEN	042	056	052	038		REALISTIC	000	003	005	011	013
INGERSOL	027						045	046			
ITT	005	041	042	056	050	REX	042	056	052		
	052	033	038			SABA	039	042	056	052	035

## Programming the Remote

### VCR Brand List

Brand	CODE No.			
SAISHO	002	010	025	027
SALORA	005	017		
SAMSUNG	013	019	032	
SANSUI	042			
SANYO	000	003	005	025 038
SBR	018	029		
SCHAUB LORENZ	041	042	056	050 052
	038			
SCHNEIDER	008	011	045	031
SEI-SINUDYNE	027			
SELECO	042	056	052	
SENTRA	020			
SHARP	045	046	105	048
SHINTOM	008			
SIEMENS	014	043	055	031 054
	038			
SIERA	045	031		
SINUDYNE	027			
SONY	044	015	016	026 028
STERN	042	056	052	
STS	006			
SUNKAI	025			
SYLVANIA	011	017		
SYMPHONIC	011	017		
TASHIKO	011			
TATUNG	011	042		
TEAC	011	042		
TEKNIKA	011			
TELEAVIA	042	056	052	
TELEFUNKEN	042	056	052	
TENOSAL	008			
THOMSON	042	056	052	
THORN- FERGUSON	039	042	030	052
	034	036		
TOSHIBA	001	042	056	017
	052			
TOTELEVISION	013			
UHER	042			
ULTRA VOX	041			
UNITECH	013			
UNIVERSUM	041	014	043	
URANYA	041			
VECTOR	004			
VICTOR	042			
VIDITAL	041			
WESTING HOUSE	041			
WARDS	019			
YAMAHA	004	042		
ZANUSSI	042	056	052	
ZENDER	052			
ZOPPAS	042	056		

### SAT Brand List

Brand	CODE No.			
ALBA	030			
AMSTRAD	008	019	027	
ARCON	021			
ARISTONA	016			
ASTRA	028			
BLAUPUNKT	033			
BUSH	016			
CH.MASTER	030			
CITY COM	005			
DDC	030			
DYNASAT	005			
ECHOSTAR	002	009	032	020
EMME ESSE	005			
FAIT	005			
FERGUSON	014		016	017 018
FINLUX	006	007	013	
FRACARRO	005			
FTE	022			
GOLDSTAR	004	021		
GRAETZ	026	037		
GROTHUSEN	004			
GRUNDIG	033	016	018	036
HINARI	030			
HIRSCHMANN	003	006		
HITACHI	013			
INGELEN	026	037		
ITT	034			
ITT-NOKIA	032	018	026	037
JERROLD		014		
KATHREIN	005	022	023	
KOSMOS	004			
KRIESLER	016			
LENCO	004	021		
LUXOR	026	037		
MAGAI	022			
MARANTZ	012			
MASPRO	016			
MATSUSHITA	000			
METZ	036			
MINERVA	036			
MULTISTAR	022			
MURATO	004			
NEC				
NEIRU	021			
NOKIA	026	037		
NORSAT	015			
PACE	001	016	017	018
PANASONIC	032			

## Programming the Remote

### SAT Brand List

Brand	CODE No.			
PHILIPS	003	011	012	029
PHONOLA	016			
PROSAT	030			
PYE	016			
QUADRAL	030			
QUELLE	036			
RADIOLA	016			
REDIFFUSION	015			
SABA	035			
SALORA	026			
SAMSUNG	003	022		
SAT PARTNER	004			
SATPORTNER	021			
SCHAUB LORENZ	026	037		
SCHNEIDER	005	016		
SIEMENS	033	036		
SIERA	016			
SILVA	004	021		
SKY				
STARCOM				
STARSAT	022			
TECHNISAT	003			
TELEFUNKEN	025			
TELESYSTEM	005			
THORN- FERGUSON	010	014	016	017
	018			
TRIAD	004			
UNIDEN	022			
UNITED CABLE				
V TECHNOLOGY	004			
VORTEC	003	024	025	
ZENDER	022			

### TV Brand List

Brand	CODE No.				
ADMIRAL	050	134			
AKAI	093	049	123		
ALBA	068				
ALBIRAL	116				
ALCATEL	022				
AMSTRAD	021				
ANAM	000				
ARC EN CIEL	028	039	043	145	081
ARISTONA	099	049	050	019	142
	149	078			
ARTHUR MARTIN	053	139	117	120	122
	123	125	128		
ASA	050	055	057	113	134
ATLANTIC	099	111			
AUDIOSONIC	054				
AUSIND	053				
AUTOVOX	099	144	055	019	057
	069				
BAIRD	083				
BASICLINE	006				
BAUR	011				
BEKO	023	049			
BLAUPUNKT	094	100	102	111	114
BRANDT	028	039	040	043	145
	081				
BRION VEGA	050				
BRUNS	048	050			
BSR	059	110	132		
BUSH	033	068	124	074	
CENTURY	098	101	050	079	136
CGE	016	101	124	079	132
	136				
CIHAN	065				
CLARIVOX	048	116			
CONDOR	099	111			
CONTEC	087				
CONTINENTAL					
EDITION	028	039	040	043	145
	081				
CROSLEY	101	050	109		
CROWN	147				
CTC CLATRONIC	046				
DAEWOO	089				
DECCA	099	060	063	115	118
DEGRAAF	036				
DIXI	049	090			
DRYNATRON	049				
DUAL	099	141			
DUAL-TEC	096	099	132		
DUMONT	046	050	057	073	
ELBE		016	116		
ELBIT	065				
ELCIT	046	097	103	050	109
	127	132			
ELMAN	046	132			
ELTA	090				
EMERSON	098	050			

## Programming the Remote

### TV Brand List

Brand	CODE No.					Brand	CODE No.				
ERRES	049	142				KAISUI	006				
EUROPHON	098	046	097	099	051	KARCHER	006				
	115	132				KENDO	098				
FERGUSON	146	040	041	150	057	KENNEDY	144	019	109		
	061	116	149			KORTING	050	059	111		
FIDELITY	099	149				KRIESLER	099	049	050	019	142
FINLUX	034	046	053	055	057		149	078			
	109	113	073	074	079	LENOIR	099				
FISHER	015	048	050	052	109	LOEWE OPTA	008	097	047	049	050
	136						115	072			
FORGESTONE	149					LOGIK	118	149			
FORMENTI	099	053	109	111	125	LUMA	049	120	134		
FORTRESS	137					LUXOR	058	139	117	120	123
FRABA	075						129	135	083		
FRONTECH	054					MAGNADYNE	046	097	103	050	109
FUJITSU	025						115	127	132		
FUNAI	054	059				MAGNAFON	046	097	099	051	053
GBC	109	132					115				
GEC	099	060	109	115	134	MARANTZ	049				
	088					MATSUI	090	099	106	060	118
GELOSO	103	109	132	134	090		068	134			
GOLDSTAR	092	003	017	099	049	McMICHAEL	088				
	075	076	077	090		MEMOREX	090				
GOODMANS	033	049	060	077		METZ	094	050	114	133	
GORENJE	066	136				MINERVA	094	100	057	058	114
GREATZ	001	058	109	122	123	MISTRAL	149				
	128	129	130	134		MITSUBISHI	033	035	047	049	050
GRANADA	033	099	049	058	060		062	118	119	148	080
	142	115	125	134			138				
GRUNDIG	094	100	057	058	108	MIVAR	097	099	115	077	
	112	114	082			MULTITECH	046	099	115	136	
HANSEATIC	033	047	099	049	109	MURPHY	134				
	139	111				MAONIS	096	144	019	110	134
HANTAREX	097					NATIONAL	042	104	109		
HEMMERMANN	127					NEC	033	085			
HIFIVOX	028	039	043	145	081	NECKERMANN	099	050	139	120	136
HINARI	033	045	143	090		NEI	049				
HITACHI	014	033	034	036	099	NIKKAI	060				
	145	056	109	139	110	NOBLEX	015				
	067	117	132	134	084	NOBLIKO	098	046	099	053	057
	091	081	088			NOGAMATIC	028	039	043	145	081
HYPER	093	099				NOKIA	001	140	058	105	109
IMPERIAL	016	101	124	079	132		122	123	128	148	129
	133						130	134	135	083	089
INGELEN	001	058	109	122	128	NORDMENDE	028	032	039	043	145
	129	130	134				131	091	081		
INNO HIT	093	098	097	099	143		109	064	123		
	077	090				OCEANIC	099				
INTERFUNK	047	049	050	145	058	ONCEAS	099				
	109	142	123	128	129	OPTONICA	137				
	091					ORION	090	059	118	068	127
IRRADIO	093	143	053	077	090	OSAKI	060				
ITT	001	140	058	105	109	OSIO	077				
	122	123	128	148	129	OSUME	087				
	130	134	135	083	089	OTTO VERSAND	033	047	049	109	139
JVC	033					P.T ACTTRON	065				
KTV	099					PAEL	099	053			
						PANASONIC	030	042	095	104	107



## Programming the Remote

### TV Brand List

Brand	CODE No.					Brand	CODE No.				
	109	121	126			SELECO	016	096	144	019	141
PATHE CINEMA	099	111	116	132			110	069	134		
PERDIO	060					SHARP	033	087	137		
PHILCO	016	030	101	050	109	SIAREM	046	097	050	109	115
	124	079	132	136		SICATEL	116				
PHILIPS	009	010	013	018	024	SIEMENS	005	094	036	100	111
	099	049	050	019	142		114	087			
	148	149	078	088		SIERA	099	049	050	019	142
PHOENIX	099	053	109	111	125		149	078			
PHONOLA	099	049	050	019	142	SILVER	054				
	149	078				SINGER	016	046	050	109	
PIONEER	020	049	145	091		SINUDYNE	127	046	050	059	109
PRANDONI-						SONOKO	049	090			
PRINCE	098	097	053	115	134	SONY	146	007	027	033	038
PREMIER	124						118				
PRINCE	098	097	053	134		STERN	096	144	019	110	069
PROTECH	049	054					134				
PYE	099	049	050	019	142	TANDBERG	133				
	148	149	078			TANDY	099	060	137		
QUASAR	046	097	051	053	077	TASHIKO	002	033			
QUELLE	047	099	100	049	053	TATUNG	099	060	063	065	115
	055	057	058	111	112		118				
	113	114	118	123	073	TEC	096	099	132		
	074	128				TELEAVIA	028	039	040	043	145
RADIOLA	099	049	050	019	142		091	081			
	149	078				TELEFUNKEN	028	041	145	150	086
RADIOMARELLI	046	097	103	050	109		091				
	062	127	132			TELETECH	090				
RANK	074					TELEVIDEON	099	053	109	111	125
RBM	074					TENSAI	049				
REDIFFUSION	062	123	134			THOMSON	012	028	032	039	040
REX	096	144	019	141	110		043	145	091	081	
	069	134				THORN-					
ROBOTRON	048	050				FERGUSON	014	040	041	054	150
RTF	048	050					057	061	116	149	086
SABA	028	031	032	037	039	TOCOM	029				
	040	043	097	050	145	TOSHIBA	004	016	033	070	074
	115	120	086	091	081	TRANS					
SAISHO	090	099	118	119	068	CONTINENTS	098	097	053	134	
SALORA	053	139	117	120	122	UHER	052	111	125		
	123	125	128	135	083	ULTRA VOX	098	046	099	050	109
SAMBERS	046	097	051	053	115		120				
	077					UNIVERSUM	092	034	054	077	
SAMPO	121					UNIVOX	116				
SAMSUNG	015	026	099	054	077	VEGAVOX	079				
	136	090				VOXSON	050	134			
SANYO	001	002	005	033	044	WATSON	111				
	048	060	113	118	071	WATT RADIO	046	099	051	109	116
	054	136					127				
SBR	049	142	148	149	088	WEGA	033				
SCHAUB LORENZ	001	058	109	122	123	WHITE					
	128	129	130	134		WESTINGHOUSE	099	111			
SCHNEIDER	096	099	049	050	052	YOKO	099				
	019	141	109	142	125	ZANUSSI	096	144	019	110	069
	149	078	132				134				
SEG	046					ZOPPAS	096	144	019	110	134
SEI	059										

## Troubleshooting

SYMPTOM	CAUSE	SOLUTION
Unit does not function when Main Power Switch is pushed	<ul style="list-style-type: none"> <li>No AC power</li> </ul>	<ul style="list-style-type: none"> <li>Make certain AC power cord is plugged into a live outlet.</li> <li>Check to see whether outlet is switch-controlled.</li> </ul>
Display lights, but no sound or picture	<ul style="list-style-type: none"> <li>Intermittent input connections</li> <li>Mute is on</li> <li>Volume control is down</li> </ul>	<ul style="list-style-type: none"> <li>Make certain that all input and speaker connections are secure.</li> <li>Press Mute Button.</li> <li>Turn up volume control.</li> </ul>
Unit turns on, but front-panel display does not light up	<ul style="list-style-type: none"> <li>Display brightness is turned off</li> </ul>	<ul style="list-style-type: none"> <li>Follow the instructions in the Display Mode (27 page) so that the display is set to FULL.</li> </ul>
No sound from any speaker; light around power switch is red	<ul style="list-style-type: none"> <li>Amplifier is in protection mode due to possible short</li> <li>Amplifier is in protection mode due to internal problems</li> </ul>	<ul style="list-style-type: none"> <li>Check speaker wire connections for shorts at receiver and speaker ends.</li> <li>Contact your local LUXMAN service center.</li> </ul>
No sound from surround or center speakers	<ul style="list-style-type: none"> <li>Incorrect surround mode</li> <li>Input is monaural</li> <li>Incorrect configuration</li> <li>Stereo or Mono program material</li> </ul>	<ul style="list-style-type: none"> <li>Select a mode other than Stereo.</li> <li>There is no surround information from mono sources.</li> <li>Check speaker mode configuration.</li> <li>The surround decoder may not create center- or rear-channel information from nonencoded programs.</li> </ul>
Unit does not respond to remote commands	<ul style="list-style-type: none"> <li>Weak batteries in remote</li> <li>Wrong device selected</li> <li>Remote sensor is obscured</li> </ul>	<ul style="list-style-type: none"> <li>Change remote batteries.</li> <li>Press the FUNCTION buttons.</li> <li>Make certain front-panel sensor is visible to remote, or connect remote sensor.</li> </ul>
Intermittent buzzing in tuner	<ul style="list-style-type: none"> <li>Local interference</li> </ul>	<ul style="list-style-type: none"> <li>Move unit or antenna away from computers, fluorescent lights, motors or other electrical appliances.</li> </ul>
Letters flash in the channel indicator display and digital audio stops	<ul style="list-style-type: none"> <li>Digital audio feed paused</li> </ul>	<ul style="list-style-type: none"> <li>Resume play for DVD.</li> <li>Check that Digital Input is selected.</li> </ul>

## Specifications

### Amplifier Section

#### Output Power

Power Output (20 Hz - 20 kHz, THD<0.07%, 8 ohms)

Front L&R	85 W / Ch
Center	85 W / Ch
Surround L & R	85 W / Ch
Surround Back	85 W / Ch

Power Output (EIAJ, 1 kHz, 8 ohms)

Front L&R	105 W / Ch
Center	105 W / Ch
Surround L & R	105 W / Ch
Surround Back	105 W / Ch

Input Sensitivity/Impedance

Linear (High-Level) 220mV/47k ohms

Signal-to-Noise Ratio (IHF-A) 95dB

Surround System Adjacent Channel Separation

Pro Logic	40dB
Dolby Digital (AC-3)	55dB
DTS	55dB

Frequency Response

@ 1W (+0dB, -3dB) 10Hz - 100kHz

Tone Control:

BASS: ± 10 dB at 100 Hz

TREBLE: ± 10 dB at 10 kHz

### Digital Audio Section

Sampling Frequency: 32 kHz, 44.1 kHz, 48 kHz, 96 kHz

DIGITAL Input Level/Impedance:

OPTICAL : -15 dBm — -21 dBm

COAXIAL : 0.5 Vp-p / 75 ohms

### FM Tuner Section

(Without notes 100.1 MHz, 65 dBf)

Tuning Range:

87.5 MHz – 108.0 MHz (50 kHz steps)

Usable Sensitivity (IHF):

Mono : 11.2 dBf

50 dB Quieting Sensitivity:

Mono : 18.3 dBf

Stereo: 38.5 dBf

Capture Ratio: 2.0 dB

Image Rejection Ratio: 80 dB

AM Suppression Ratio: 55 dB

Total Harmonic Distortion (1 kHz):

Mono : 0.2%

Stereo: 0.3%

Frequency Response: 15 Hz – 16 kHz, +1/ -1.5 dB

Stereo Separation (1 kHz): 40 dB

Signal-to-Noise Ratio (IHF-A):

Mono : 70 dB

Stereo: 68 dB

### AM Tuner Section

Tuning Range: 522 kHz – 1,620 kHz (9 kHz steps)

Usable Sensitivity: 55 dB/m

Total Harmonic Distortion: 0.8%

Signal-to-Noise Ratio: 40 dB

### Video Section

Television Format : PAL / NTSC

Input Level/Impedance : 1Vp-p/75 ohms

Output Level/Impedance : 1Vp-p/75 ohms

Video Frequency Response

(Composite and S-Video) : 10Hz-5.8MHz (-1dB)

Video Frequency Response

(Component Video) : 10Hz-50MHz (-3dB)

### General

Power Requirements:

AC 220-240 V~, 50/60 Hz

Power Consumption:

270W

AC Outlets:

Switched x , 100 W max.

Dimensions (W x H x D)

440 x 160 x 385 mm

Weight (net): 11.3Kg

Standard Accessories:

AM Loop Antenna x 1

FM Antenna x 1

Remote Control Unit x 1

AAA-size Batteries x 2

Owner's Manual x 1

\* LINE means CD, TAPE, VIDEO 1, VIDEO 2, AUX 1, DVD.

\* Manufactured under license from Dolby Laboratories. "Dolby," "Pro Logic" and the Double-D symbol are trademarks of Dolby Laboratories.

DTS, DTS Surround, DTS-ES and DTS Neo:6, DTS 96/24 are registered trademarks of Digital Theater Systems, Inc.

● Improvements may result in specifications and features changing without notice.

● Illustrations may differ slightly from production models.

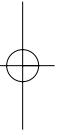
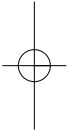
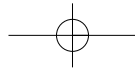

**LUXMAN CORPORATION, JAPAN**

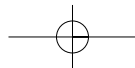

## Free Manuals Download Website

<http://myh66.com>

<http://usermanuals.us>

<http://www.somanuals.com>

<http://www.4manuals.cc>

<http://www.manual-lib.com>

<http://www.404manual.com>

<http://www.luxmanual.com>

<http://aubethermostatmanual.com>

Golf course search by state

<http://golfingnear.com>

Email search by domain

<http://emailbydomain.com>

Auto manuals search

<http://auto.somanuals.com>

TV manuals search

<http://tv.somanuals.com>