

# **PowerScan® RF**

***Handheld Bar Code Scanner  
Handstrichcodeleser  
Douchette Laser  
Lettore portatile di codici a barre***



***User's Guide  
Benutzerhandbuch  
Guide de L'utilisateur  
Manuale d'Istruzioni***

---

## **Datalogic Scanning, Inc.**

959 Terry Street

Eugene, Oregon 97402

Telephone: (541) 683-5700

Fax: (541) 345-7140

An Unpublished Work - All rights reserved. No part of the contents of this documentation or the procedures described therein may be reproduced or transmitted in any form or by any means without prior written permission of Datalogic Scanning, Inc. or its subsidiaries or affiliates ("Datalogic" or "Datalogic Scanning"). Owners of Datalogic products are hereby granted a non-exclusive, revocable license to reproduce and transmit this documentation for the purchaser's own internal business purposes. Purchaser shall not remove or alter any proprietary notices, including copyright notices, contained in this documentation and shall ensure that all notices appear on any reproductions of the documentation.

Should future revisions of this manual be published, you can acquire printed versions by contacting your Datalogic representative. Electronic versions may either be downloadable from the Datalogic website ([www.scanning.datalogic.com](http://www.scanning.datalogic.com)) or provided on appropriate media. If you visit our website and would like to make comments or suggestions about this or other Datalogic publications, please let us know via the "Contact Datalogic" page.

### **Disclaimer**

Datalogic has taken reasonable measures to provide information in this manual that is complete and accurate, however, Datalogic reserves the right to change any specification at any time without prior notice.

Datalogic is a registered trademark of Datalogic S.p.A. and the Datalogic logo is a trademark of Datalogic S.p.A. all licensed to Datalogic Scanning, Inc. All other trademarks and trade names referred to herein are property of their respective owners.

This product may be covered by one or more of the following patents: 4603262 • 4639606 • 4652750 • 4672215 • 4699447 • 4709369 • 4749879 • 4786798 • 4792666 • 4794240 • 4798943 • 4799164 • 4820911 • 4845349 • 4861972 • 4861973 • 4866257 • 4868836 • 4879456 • 4939355 • 4939356 • 4943127 • 4963719 • 4971176 • 4971177 • 4991692 • 5001406 • 5015831 • 5019697 • 5019698 • 5086879 • 5115120 • 5144118 • 5146463 • 5179270 • 5198649 • 5200597 • 5202784 • 5208449 • 5210397 • 5212371 • 5212372 • 5214270 • 5229590 • 5231293 • 5232185 • 5233169 • 5235168 • 5237161 • 5237162 • 5239165 • 5247161 • 5256864 • 5258604 • 5258699 • 5260554 • 5274219 • 5296689 • 5298728 • 5311000 • 5327451 • 5329103 • 5330370 • 5347113 • 5347121 • 5371361 • 5382783 • 5386105 • 5389917 • 5410108 • 5420410 • 5422472 • 5426507 • 5438187 • 5440110 • 5440111 • 5446271 • 5446749 • 5448050 • 5463211 • 5475206 • 5475207 • 5479011 • 5481098 • 5491328 • 5493108 • 5504350 • 5508505 • 5512740 • 5541397 • 5552593 • 5557095 • 5563402 • 5565668 • 5576531 • 5581707 • 5594231 • 5594441 • 5598070 • 5602376 • 5608201 • 5608399 • 5612529 • 5629510 • 5635699 • 5641958 • 5646391 • 5661435 • 5664231 • 5666045 • 5671374 • 5675138 • 5682028 • 5686716 • 5696370 • 5703347 • 5705802 • 5714750 • 5717194 • 5723852 • 5750976 • 5767502 • 5770847 • 5786581 • 5786585 • 5787103 • 5789732 • 5796222 • 5804809 • 5814803 • 5814804 • 5821721 • 5822343 • 5825009 • 5834708 • 5834750 • 5837983 • 5837988 • 5852286 • 5864129 • 5869827 • 5874722 • 5883370 • 5905249 • 5907147 • 5923023 • 5925868 • 5929421 • 5945670 • 5959284 • 5962838 • 5979769 • 6000619 • 6006991 • 6012639 • 6016135 • 6024284 • 6041374 • 6042012 • 6045044 • 6047889 • 6047894 • 6056198 • 6065676 • 6069696 • 6073849 • 6073851 • 6094288 • 6112993 • 6129279 • 6129282 • 6134039 • 6142376 • 6152368 • 6152372 • 6155488 • 6166375 • 6169614 • 6173894 • 6176429 • 6188500 • 6189784 • 6213397 • 6223986 • 6230975 • 6230976 • 6237852 • 6244510 • 6259545 • 6260763 • 6266175 • 6273336 • 6276605 • 6279829 • 6290134 • 6290135 • 6293467 • 6303927 • 6311895 • 6318634 • 6328216 • 6332576 • 6332577 • 6343741 • 6454168 • 6478224 • 6568598 • 6578765 • 6705527 • 6974084 • 6991169 • 7051940 • AU703547 • D312631 • D313590 • D320011 • D320012 • D323492 • D330707 • D330708 • D349109 • D350127 • D350735 • D351149 • D351150 • D352936 • D352937 • D352938 • D352939 • D358588 • D361565 • D372234 • D374630 • D374869 • D375493 • D376357 • D377345 • D377346 • D377347 • D377348 • D388075 • D446524 • EP0256296 • EP0260155 • EP0260156 • EP0295936 • EP0325469 • EP0349770 • EP0368254 • EP0442215 • EP0498366 • EP0531645 • EP0663643 • EP0698251 • GB2252333 • GB2284086 • GB2301691 • GB2304954 • GB2307093 • GB2308267 • GB2308678 • GB2319103 • GB2333163 • GB2343079 • GB2344486 • GB2345568 • GB2354340 • ISR107546 • ISR118507 • ISR118508 • JP1962823 • JP1971216 • JP2513442 • JP2732459 • JP2829331 • JP2953593 • JP2964278 • MEX185552 • MEX187245 • RE37166 • Other Patents Pending

# Datalogic Scanning, Inc.

## POWERSCAN® END USER LICENSE AGREEMENT

**Notice to End User:** The Datalogic Product you have acquired contains embedded Software, which is integral to the product's operation. This Software is being provided to you under license, subject to the terms and conditions of this Agreement. If you use the Datalogic Product, you will be deemed to have accepted the terms and conditions of this Agreement. If you do not intend to be bound to the terms of this Agreement, Datalogic is not willing to license the Software to you, you may not use the Datalogic Product or the Software, and you must contact the party from whom you acquired the Datalogic Product for instructions.

This End User Software License Agreement ("Agreement") is a legally binding agreement governing the licensing of the Software and Documentation by Datalogic, Scanning Holdings, Inc. and its wholly owned subsidiaries and affiliates ("Datalogic") to the entity or person who has purchased or otherwise acquired a Datalogic Product ("End User"). For purposes of this Agreement, any software that is associated with a separate end-user license agreement is licensed to you under the terms of that license agreement. Datalogic and End User hereby agree as follows:

### **1. Definitions.**

- 1.1 "Documentation" means materials such as user's guides, program reference guides, quick reference guides, manuals, or similar materials associated with or related to the Datalogic Product, whether in printed, "online", or other form.
- 1.2 "Proprietary Information" means: (a) source code, object code, software, documentation, and any related internal design, system design, data base design, algorithms, technology, technical data or information, implementation techniques, and trade secrets related to the Software, (b) any other trade secrets marked appropriately or identified as proprietary or confidential, and (c) any information that End User, under the circumstances, should recognize as confidential. Proprietary Information does not include any information that the receiving party can establish was (1) in the public domain, (2) already in the receiving party's possession or rightfully known prior to receipt, (3) rightfully learned from a third party not in violation of any other's proprietary rights, or (4) independently developed without access to Proprietary Information.
- 1.3 "Datalogic Product" means the Datalogic Powerscan® series, Powerscan® Imager series, Powerscan® EP series, Powerscan® LR series, Powerscan® HD series, and/or Powerscan RF® series scanner and/or scanner/scale product, including all embedded Software in and all Documentation related to such product, which has been purchased or otherwise acquired by End User, whether obtained directly or indirectly from Datalogic.
- 1.4 "Software" means any software or computer programs of Datalogic or its third party licensors in machine readable form which is embedded in the Datalogic Product, whether obtained directly or indirectly from Datalogic, including any replacement, update, upgrade, enhancement or modification.

### **2. Scope Of License Granted.**

- 2.1 Datalogic grants to End User a non-exclusive, non-transferable, perpetual license to use the Software, solely on the Datalogic Product in which it is embedded ("designated Datalogic Product"), in machine-readable form only, solely for End User's internal business purposes. This Agreement does not convey ownership of the Software to End User. Title to the Software shall be and remain with Datalogic or the third party from whom Datalogic has obtained a licensed right. As used in this Agreement, the term "purchase" or its equivalents when applied to the Software shall mean "acquire under license." End User is not entitled to receipt or use of the source code to any Software.
- 2.2 End User shall not copy, modify, decompile, disassemble, reverse engineer, or otherwise reproduce or remanufacture the Software, whether modified or unmodified, nor sell, assign, sublicense, distribute, lend, rent, give, or otherwise transfer the Software to any other person or organization, for purposes other than as expressly provided in this Agreement, without Datalogic's prior written consent.

### **3. Transfers, Support.**

- 3.1 Any copying, installing, reproduction, remanufacture, reverse engineering, electronic transfer, or other use of the Software on other than the designated Datalogic Product will be a material breach of this Agreement. However, Datalogic may elect not to terminate this Agreement or the granted licenses, but instead may elect to notify End User that End User is deemed to have ordered and accepted a license for each breaching use. End User shall pay Datalogic the applicable list price for such licenses as of the date of such breach.
- 3.2 End User shall not sell, assign, sublicense, distribute, lend, rent, give, or otherwise transfer the Datalogic Product to any third party unless such third party agrees with Datalogic in writing to be bound by the terms and conditions of this Agreement. Any such transfer of the Datalogic Product absent such agreement shall be null and void.
- 3.3 End User may obtain support for Software from Datalogic at Datalogic's standard support fees and under Datalogic's standard support terms and conditions in effect at the time the support is requested.

### **4. Intellectual Property.**

End User acknowledges that the Software constitutes valuable trade secrets of Datalogic or Datalogic's third party licensors and that the Software is protected by intellectual property laws and treaties. The license set forth in this Agreement does not transfer to End User any ownership of Datalogic's or its third party licensors' copyrights, patents, trademarks, service marks, trade secrets, or other intellectual property rights and End User shall have no right to commence any legal actions to obtain such rights. End User shall not remove, modify, or take any other action that would obscure any copyright, trademark, patent marking, or other intellectual property notices contained in or on the Datalogic Product.

### **5. Proprietary Information.**

- 5.1 End User acknowledges that Proprietary Information is the confidential, proprietary, and trade secret property of Datalogic and Datalogic's third party licensors and End User acquires no right or interest in any Proprietary Information.
- 5.2 End User shall not disclose, provide, or otherwise make available the Proprietary Information of Datalogic or its third party licensors to any person other than End User's authorized employees or agents who are under confidentiality agreement, and End User shall not use the Proprietary Information other than in conjunction with use of the Datalogic Product exclusively for End User's internal business purposes. End User shall take steps to protect the Proprietary Information no less securely than if it were End User's own intellectual property.
- 5.3 The provisions of this Proprietary Information Section shall survive and continue for five (5) years after the termination of this Agreement.

### **6. Limited Warranty.**

- 6.1 Datalogic warrants that, under normal use and operation, the Datalogic Product will conform substantially to the applicable Documentation for the period specified in the Documentation. During this period, for all reproducible nonconformities for which Datalogic has been given written notice, Datalogic will use commercially reasonable efforts to remedy nonconformities verified by Datalogic. End User agrees to supply Datalogic with all reasonably requested information and assistance necessary to help Datalogic in remedying such nonconformities. For all defects reported to Datalogic within the

warranty period, Datalogic's liability is limited to providing End User with one copy of corrections or responding to End User's problem reports according to Datalogic's standard assistance practices. Datalogic does not warrant that the product will meet End User's requirements or that use of the product will be uninterrupted or error free, or that Datalogic's remedial efforts will correct any nonconformance. This limited warranty does not cover any product that have been subjected to damage or abuse, whether intentionally, accidentally, or by neglect, or to unauthorized repair or unauthorized installation, and shall be void if End User modifies the product, uses the product in any manner other than as established in the Documentation, or if End User breaches any of the provisions of this Agreement.

- 6.2 EXCEPT AS PROVIDED IN THIS AGREEMENT, THE DATALOGIC PRODUCT IS PROVIDED "AS IS" AND DATALOGIC MAKES NO WARRANTIES OF ANY KIND, EXPRESS OR IMPLIED, WRITTEN OR ORAL, WITH RESPECT TO THE PRODUCT, AND SPECIFICALLY DISCLAIMS THE IMPLIED WARRANTIES OF MERCHANTABILITY AND FITNESS FOR A PARTICULAR PURPOSE.

#### **7. Infringement.**

- 7.1 Datalogic will defend End User against any claim in a lawsuit that the Datalogic Product furnished hereunder infringe a United States patent or copyright of a third party and Datalogic will pay any damages finally awarded against End User by a court of competent jurisdiction that are attributable to such claim or will pay End User's part of any settlement that is attributable to such claim, provided, that 1) End User notifies Datalogic promptly in writing of the claim, 2) Datalogic controls the defense or settlement of the claim, and 3) End User cooperates fully with Datalogic in such defense or settlement. All notices of a claim should be sent to Datalogic Scanning, Inc., Legal Department, 111 SW Fifth Ave. Suite 4100, Portland, OR 97204-3644.
- 7.2 In the defense or settlement of any such claim, Datalogic may, at its option, 1) procure for End User the right to continue using the Datalogic Product, 2) modify the Datalogic Product so that it becomes non-infringing, 3) replace the Datalogic Product with an equivalent product not subject to such claim, or 4) provide End User an opportunity to return the Datalogic Product and receive a refund of the purchase price paid, less a reasonable allowance for use.
- 7.3 Datalogic shall have no liability to End User for claims of infringement based upon 1) the use of any Datalogic Product in combination with any product which Datalogic has not either furnished or authorized for use with such Datalogic Product 2) the use of any Datalogic Product designed, manufactured, or modified to the specifications of End User, or 3) End User's modification of the Datalogic Product without written authorization from Datalogic.
- 7.4 THE FOREGOING STATES DATALOGIC'S COMPLETE AND ENTIRE OBLIGATION CONCERNING CLAIMS OF PATENT, COPYRIGHT, OR OTHER INTELLECTUAL PROPERTY INFRINGEMENT, CANCELS AND SUPERCEDES ANY PRIOR AGREEMENTS, WHETHER ORAL OR WRITTEN, BETWEEN THE PARTIES CONCERNING SUCH CLAIMS, AND WILL NOT BE MODIFIED OR AMENDED BY ANY PAST, CONTEMPORANEOUS, OR FUTURE AGREEMENTS OR DEALINGS BETWEEN THE PARTIES, WHETHER ORAL OR WRITTEN, EXCEPT AS SET FORTH IN A FUTURE WRITING SIGNED BY BOTH PARTIES.

#### **8. Limitation Of Liability.**

EXCEPT AS PROVIDED IN SECTION 7, DATALOGIC SHALL NOT BE LIABLE FOR ANY CLAIMS AGAINST END USER BY ANY OTHER PARTY. IN NO EVENT SHALL DATALOGIC'S LIABILITY FOR DAMAGES, IF ANY, WHETHER BASED UPON CONTRACT, TORT (INCLUDING NEGLIGENCE), PRODUCT LIABILITY, STRICT LIABILITY, WARRANTY, OR ANY OTHER BASIS, EXCEED THE PRICE OR FEE PAID BY END USER FOR THE DATALOGIC PRODUCT. UNDER NO CIRCUMSTANCES SHALL DATALOGIC BE LIABLE TO END USER OR ANY THIRD PARTY FOR LOST PROFITS, LOST DATA, INTERRUPTION OF BUSINESS OR SERVICE, OR FOR ANY OTHER SPECIAL, CONSEQUENTIAL, CONTINGENT, INDIRECT, INCIDENTAL, PUNITIVE, EXEMPLARY, OR OTHER SIMILAR DAMAGES, EVEN IF DATALOGIC HAS BEEN ADVISED OF THE POSSIBILITY OF SUCH DAMAGES.

#### **9. Government Restricted Rights: International Use.**

- 9.1 Use, duplication, or disclosure of the Software by the U.S. Government is subject to the restrictions for computer software developed at private expense as set forth in the U.S. Federal Acquisition Regulations at FAR 52.227-14(g), or 52.227-19 or in the Rights in Technical Data and Computer Software clause at DFARS 252.227-7013(c)(1)(ii), whichever is applicable.
- 9.2 If End User is using the Datalogic Product outside of the United States, End User must comply with the applicable local laws of the country in which the Datalogic Product is used, with U.S. export control laws, and with the English language version of this Agreement. The provisions of the "United Nations Convention on International Sale of Goods" shall not apply to this Agreement.

#### **10. Termination.**

- 10.1 Either party may terminate this Agreement or any license granted under this Agreement at any time upon written notice if the other party breaches any provision of this Agreement.
- 10.2 Upon termination of this Agreement, End User immediately shall cease using any non-embedded software and shall return to Datalogic or destroy all non-embedded software covered by this Agreement, and shall furnish Datalogic with a certificate of compliance with this provision signed by an officer or authorized representative of End User. For embedded software, End User agrees to sign a waiver prepared by Datalogic concerning further use of the embedded Software. End User's resumed or continued use of the embedded Software after termination shall constitute End User's agreement to be bound by the terms and conditions of this Agreement for such use.

#### **11. General Provisions.**

- 11.1 Entire Agreement; Amendment. This document contains the entire agreement between the parties relating to the licensing of the Software and supercedes all prior or contemporaneous agreements, written or oral, between the parties concerning the licensing of the Software. This Agreement may not be changed, amended, or modified except by written document signed by Datalogic.
- 11.2 Notice. All notices required or authorized under this Agreement shall be given in writing, and shall be effective when received, with evidence of receipt. Notices to Datalogic shall be sent to the attention of Contract Administration, Datalogic Scanning, Inc., 959 Terry Street, Eugene, OR 97402, or such other address as may be specified by Datalogic in writing.
- 11.3 Waiver. A party's failure to enforce any of the terms and conditions of this Agreement shall not prevent the party's later enforcement of such terms and conditions.
- 11.4 Governing Law; Venue. This Agreement and the rights of the parties hereunder shall be governed by and construed in accordance with the laws of the State of Oregon U.S.A, without regard to the rules governing conflicts of law. The state or federal courts of the State of Oregon located in either Multnomah or Lane counties shall have exclusive jurisdiction over all matters regarding this Agreement, except that Datalogic shall have the right, at its absolute discretion, to initiate proceedings in the courts of any other state, country, or territory in which End User resides, or in which any of End User's assets are located.
- 11.5 Attorneys' Fees. In the event an action is brought to enforce the terms and conditions of this Agreement, the prevailing party shall be entitled to reasonable attorneys' fees, both at trial and on appeal.

- END -

# Standard Warranty

Datalogic warrants to Customer that Datalogic's products will be free from defects in materials and workmanship for a period of three years from product shipment.

In order to obtain service under this Warranty, Customer must notify Datalogic of the claimed defect before the expiration of the Warranty period and obtain from Datalogic a return authorization number for return of the product to designated Datalogic service center. If Datalogic determines Customer's claim is valid, Datalogic will repair or replace product without additional charge for parts and labor. Customer shall be responsible for packaging and shipping the product to the designated Datalogic service center, with shipping charges prepaid. Datalogic shall pay for the return of the product to Customer if the shipment is to a location within the country in which the Datalogic service center is located. Customer shall be responsible for paying all shipping charges, duties, taxes, and any other charges for products returned to any other locations.

Warranty is subject to the limitations and exclusions set forth below. Warranty set forth above is in lieu of any other warranties, expressed or implied, including merchantability and fitness.

## Exclusions

Warranty coverage shall not apply to any claimed defect, failure or damage which Datalogic determines was caused by: improper use of product; failure to provide product maintenance, including but not limited to cleaning of the scan windows in accordance with product manual; installation or service of product by other than Datalogic representatives; use of product with any other instrument, equipment or apparatus; modification or alteration of product. External cables and replacement of scan windows due to scratching, stains or other degradation will not be covered under the Warranty. Products returned for service must be accompanied by the original external power supplies for performance of service.

## Limitations of Liability

Datalogic repair or replacement of defective product as set forth above is the customer's sole and exclusive remedy on account of claims of breach of warranty or product defect. Under no circumstances will Datalogic be liable to customer or any third party for any lost profits, or any incidental, consequential indirect, special or contingent damages regardless of whether Datalogic had advance notice of the possibility of such damages.

### Assignment

Customer may not assign or otherwise transfer its rights or obligations under Warranty except to a purchaser or transferee of product. No attempted assignment or transfer in violation of this provision shall be valid or binding upon Datalogic.

## Risk of Loss

Customer shall bear risk of loss or damage for product in transit to Datalogic. Datalogic shall assume risk of loss or damage for product in Datalogic's possession or product being returned to Customer by Datalogic, except such loss or damage as may be caused by the negligence of Customer, its agents or employees. In the absence of specific written instructions for the return of product to Customer, Datalogic will select the carrier, but Datalogic shall not thereby assume any liability in connection with the return shipment.

# NOTES

---

---

# MASTER CONTENTS

Table of Contents .....	1
Deutsches Inhaltsverzeichnis .....	29
Français Sommaire .....	59
Italiano Indice .....	87





---

---

## TABLE OF CONTENTS

Unpack and Inspect Your Scanner .....	1
References .....	1
Quick Start Instructions .....	1
Installing the Battery .....	2
Verifying Scanner Operation .....	3
Power Supply .....	3
Connecting the Base Station to the Host Terminal .....	3
Linking the Scanner to a Base Station .....	5
Verifying Scanner-to-Base Station Communications .....	7
Using the PowerScan RF System .....	8
Battery Charging and Maintenance .....	8
Tips for Extending Battery Life .....	9
Disposing of Batteries .....	10
Four Station Charger .....	10
How to Scan .....	11
Depth of Field .....	12
LED and Beeper Indications .....	16
Active Symbologies .....	19
Enhanced Scanning for Hard-to-Read Bar Codes .....	20
Laser Cautions .....	21
Radio Frequency Interference .....	22
Maintenance .....	23
Troubleshooting .....	24
Sample Bar Codes .....	25



---

## Unpack and Inspect Your Scanner

After unpacking your new scanner, check the contents of the shipping carton to ensure all the items you ordered are included:

- PowerScan® RF handheld scanner
- Battery Pack(s)
- User's Guide (this manual)
- Optional Accessories that you ordered. (The scanner can be purchased with or without accessory kits.)

If your package contains wrong or missing components, contact your place of purchase. If there are damaged components, immediately file a claim with the carrier. You may want to save your packing material in case you need to ship the scanner at some later time.

## References

For more information about this product, its associated publications, software, and accessories, visit our website listed on the back cover of this manual.

## Quick Start Instructions

The basic steps below must be performed to set up the RF scanner. Each of these steps is detailed in this manual.

- Installing the Battery
- Verifying Scanner Operation
- Connecting the Base Station to the Host Terminal
- Linking the Scanner to a Base Station
- Verifying Scanner-to-Base Station Communications

## Installing the Battery



### NOTE

To assure maximum usage, batteries should always be fully charged before their initial use. (See “Battery Charging and Maintenance” on page 10.)

Orient the battery as shown in Figure 1, then push it into the scanner until it snaps in place. To remove the battery, push in on the release tabs on both sides of the battery’s base and pull it straight out of the scanner.

**Figure 1. Installing the Battery**

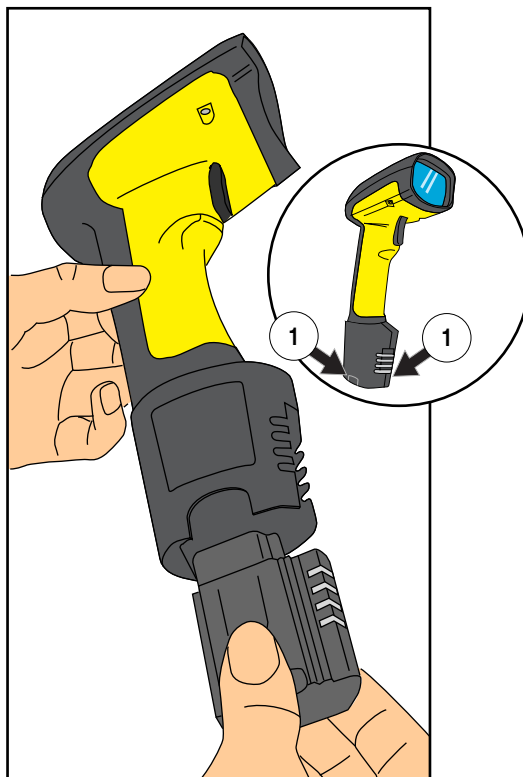

1. Battery Release Tabs

---

## Verifying Scanner Operation

Once a charged battery has been installed in the scanner, scan the sample bar codes in the back of this manual that correspond to the symbologies your scanner is programmed to read. If unsure how to do this, see the section on *How to Scan* in this manual. The system may signal with one or a combination of indicators depending upon how the scanner and Base Station are programmed to respond (see *LED and Beeper Indications* for details). If your scanner fails to read a sample bar code of a symbology it's programmed to read, turn to the section titled, *Troubleshooting*.

## Power Supply

Models require either a Listed class II or class III with a Limited Power Source (LPS).

For the safety certification to be valid, class III input power sources must be IEC/EN60950-1 (EN 60335-series, EN 60065 or relevant) approved.

Input: 100 - 240 VAC    Output: 9 - 10 VDC  
Max. Current: 2.0 A    Max. Power: 20 W

For 4-slot battery charger:

Input: 100 - 240 VAC    Output: 12 VDC  
Max. Current: 2.5 A    Max. Power: 30 W

## Connecting the Base Station to the Host Terminal



### NOTE

It is important that the interface (I/F) cable be connected to the Base Station prior to applying power to the system. This is because the interface type (RS-232, IBM, Keyboard Wedge, etc.) is selected by the Base Station subject to the I/F cable it is connected to at the time of power-up.

1. Connect the I/F cable to the Base Station (see Figure 2A). The I/F cable is inserted into the connector and the cable retainer clip is rotated over the cable overmold until the retainer snaps in place (see Figure 2B). To disconnect the cable, push in on the retainer (away from the catch on the plastic wall) to release it and enable it to swing upward, allowing the cable to be pulled free (see Figure 2C).

**Figure 2. Connecting/Disconnecting the Interface (I/F) Cable**

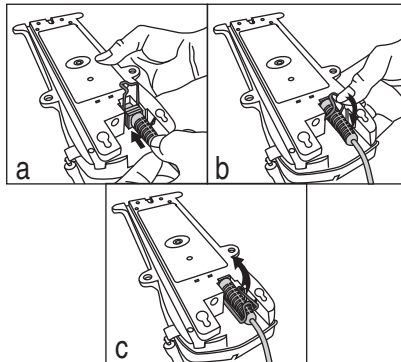

2. Consult your Host Terminal manual to determine the required communication parameters for the Host Terminal (e.g., baud rate, parity, etc.) and, if necessary, modify the programmed parameters to be compatible with those requirements. Scanner and Base Station programming is performed using one of the following:

- *Configurator Express™* Programming Software
- *PowerScan® Bar Code Scanner Programming Guide*



**NOTE**

See *References* for more information about how to obtain software and manuals for this product.



**CAUTION**

The Host Terminal manual should also be consulted as to whether power must be turned off before connecting peripheral devices. Ensure that the correct procedure is followed to avoid damage to equipment or interruption of system functions.

3. Connect the I/F cable to the proper port on the Host Terminal (check your Host Terminal manual to determine hardware requirements).
4. Connect the AC Adapter's power cord at the Base Station and plug the AC/DC adapter in at the wall outlet (see Figure 3).

---

The Base Station's POWER LED should be illuminated when the unit is properly connected to power.

**Figure 3. Connecting Power to the Base Station**

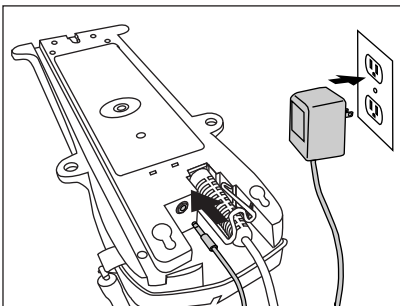

5. Apply power to the Host Terminal.
6. Verify communication with the Host Terminal by aiming the linked scanner at a sample bar code from the back pages of this manual, and pulling the trigger (see *How to Scan* for tips about scanning bar codes). Confirm that the scanner/Base Station sent the data to the host terminal. If not, see the section, *Troubleshooting*. Once all communications are verified, the system is ready for use.

### **Linking the Scanner to a Base Station**

To link a scanner to a Base Station, simply scan the Base Station ID bar code located on the top of the desired Base Station. As the scanner searches for the Base Station, a short beep is heard as it seeks for the correct channel. When the Base Station responds to the request, the scanner's beeper will either sound a "Link Granted," or "Link Denied" signal (see the section, *LED and Beeper Indications* for more information).

---

The existing Base Station system configuration can be automatically downloaded to the scanner. This automatic download feature is configurable and can be disabled. See the Systems Manual for more information about this feature. If downloading occurs, a slight delay with link verification announcement will occur.



**CAUTION**

Since a new/replacement scanner may have been shipped with a custom configuration or may have been modified with other special programming, it may not be desirable to download a potentially older configuration from an existing Base Station. In this case, reference the Systems Manual, or the *Configurator Express™* On-Screen Programming Software and consider uploading the scanner's newer configuration to the Base Station prior to linking.



---

## Verifying Scanner-to- Base Station Communications

Point the linked scanner at a sample bar code from the back pages of this manual, and pull the trigger (see *How to Scan* for tips on scanning bar codes). Watch the TX/RX (transmit/receive) indicator LED on the Base Station and/or scanner green LED while scanning the bar code. The LEDs should flash momentarily as the two devices communicate. If no communication is indicated, refer to the troubleshooting section of the Systems Manual.

When the scanner is programmed to do so, communication can also be indicated by a second "acknowledgement" tone<sup>1</sup> that is sounded after a "good read" tone. If a transmission error beep (warble) is heard following a "good read" tone instead of the single acknowledgement tone, communication between the devices may have failed<sup>2</sup>. Refer to the sections *Using the PowerScan RF System*, and *Troubleshooting* for possible remedies, should this occur.



**CAUTION**

### **Mexico ONLY**

**Operation in Mexico must voluntarily be restricted to channels 1,2,8 and 9. See RF Channel Selection in the Systems Manual to set channels. The frequency range on channels 3 through 7 have been allocated by Mexico government standards.**

- 
1. See *LED and Beeper Indications* for more details about beeper signals.
  2. Other reasons for a "warble" are that the Base Station may be configured differently than the scanner, or that the system's interface doesn't support the symbology (bar code type) you're trying to scan.

---

## Using the PowerScan RF System

This section covers the following topics:

- Battery Charging and Maintenance
- How to Scan
- LED and Beeper Indications

### Battery Charging and Maintenance



#### NOTE

When the scanner is in use, a low battery condition is indicated by a repeated two-flash signal from the scanner's green LED every time the trigger is pulled before the laser is enabled. This indicator may have been disabled via custom programming. See *LED and Beeper Indications* for more information.

Seat the scanner in the Base Station as shown in Figure 4, ensuring that the battery fully engages the station's metal contacts. The CHARGE LED on the Base Station should flash, indicating the battery is charging.

**Figure 4. Charging the Battery**

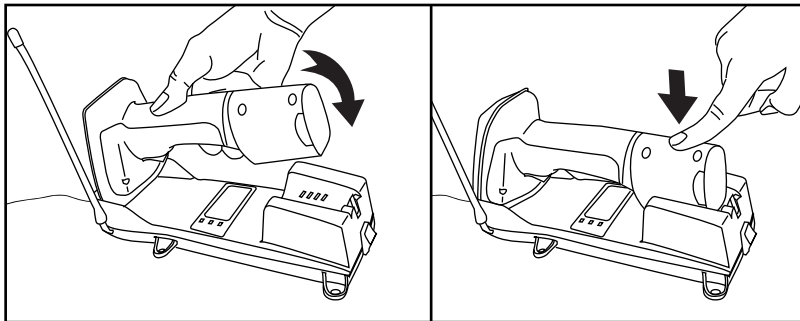

---

Rapid flashing indicates that charging is taking place. Rapid charging occurs when the battery temperature is between 10°C (50°F) and 46°C (115°F), and/or voltage of the battery is between 2.0 and 3.2V. Charge time is less than 4.2 hours. Rapid charge ends with the battery at approximately 90 to 95% capacity. The CHARGE LED remains on steady when trickle charging or after the charge cycle is complete.



**NOTE**

**A scanner may be charged simultaneously while other scanners are in use with the Base Station.**



**NOTE**

**Batteries will not charge if their temperature is below 0°C (30°F). If a battery that is too cold is inserted into the Base Station, the Charge LED will not illuminate.**

### **Tips for Extending Battery Life**

Nickel Metal Hydride (NiMH) batteries will better hold a charge if allowed to discharge at least once a week. The chemical reactions that correspond to charge and discharge in a rechargeable battery should occur to obtain the maximum number of charge/discharge cycles in the battery. If a battery is removed from the scanner and stored, it should be fully charged when stored. Batteries will lose the ability to hold a charge when stored for long periods of time (weeks, months, or longer).

Batteries will typically have about 30% charge capacity when shipped. To assure maximum usage, the battery should be fully charged before use.

Store your battery in a cool dry place. Do not leave your battery exposed to direct sunlight or temperatures below 0°C (30°F) and above 38°C (100°F).



**NOTE**

**Annual replacement of rechargeable battery packs is recommended, to ensure maximum performance.**

## Disposing of Batteries

There presently are no US, North America or World disposal requirements for NiMH batteries, so when they won't hold a charge anymore, the batteries can be disposed of, preferably through a recycling center.

## Four Station Charger

If you have a Four Station Charger, batteries are inserted for charging as shown in Figure 5. A 90% rapid charge can be achieved in only two hours when using this optional accessory, half the time than when a Base Station is used for charging. The LEDs at each battery station operate the same as the CHARGE LED on the Base Station, with rapid flashing indicating that rapid charging is taking place and on steady during trickle charging or when the rapid charge cycle is finished.

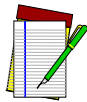

### NOTE

If you insert a battery into the Four Station Charger and no LEDs illuminate, the battery may be too cold. Batteries must be at 0°C or higher to charge. Do not attempt to charge cold batteries, since placing them in the charger will curtail the charging of other batteries already present in the unit.

Figure 5. Using the Four Station Charger Accessory

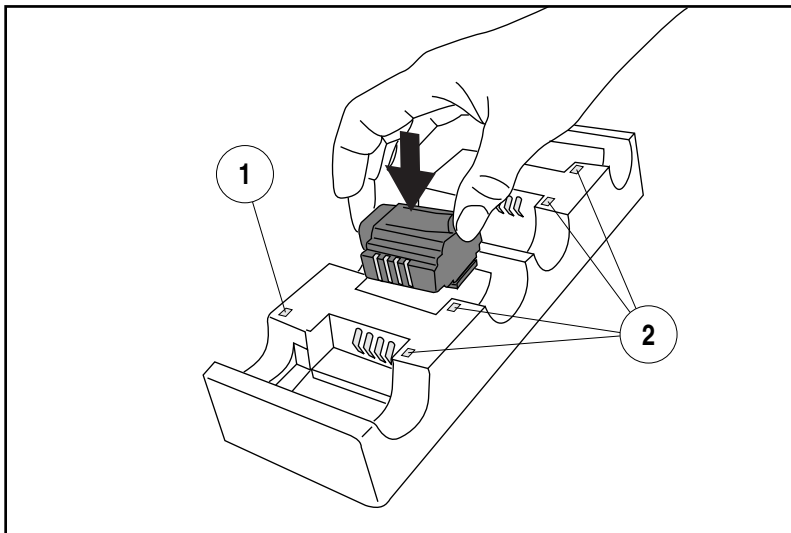

1. Device Power LED

2. Station Charge LEDs

---

## How to Scan

Figure 6 illustrates some tips to help get the best scanning results:

1. The scanner must be pointed at a slight angle to the bar code. Do not hold the scanner perpendicular to the bar code.
2. The laser beam must cross the entire bar code. The scanner cannot correctly read if the entire bar code is not scanned.

**Figure 6. Scanning Tips**

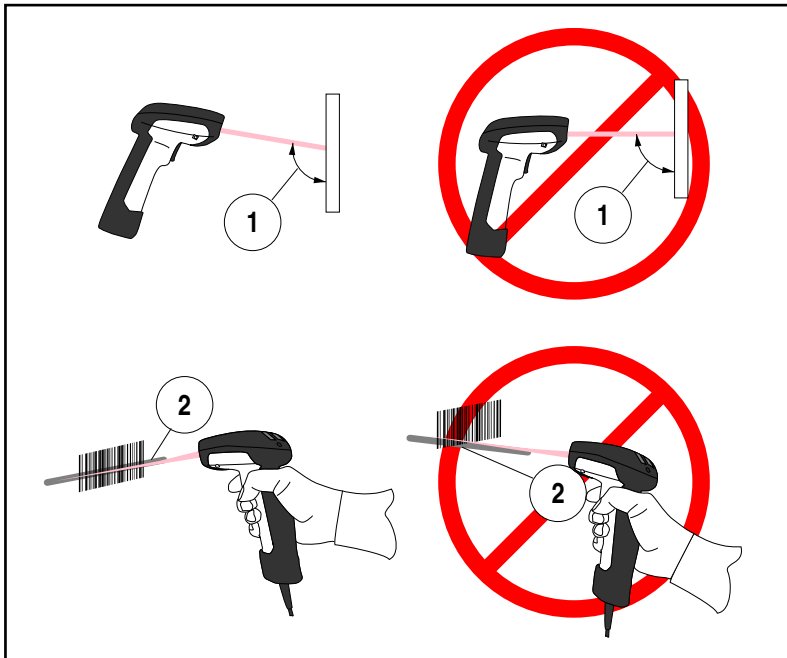

## Depth of Field

There are currently four different range models for the scanner. Depending upon the model type of your scanner, you'll need to hold the unit at a given distance from the bar code to achieve optimum scanning results. The following diagrams provide depth of field information for each of the models when scanning grade A, Code 39 bar codes: Standard Range (SR), High Density (HD), Long Range (LR) and Extra Long Range (XLR).

### Definition of a "mil"

A "mil" is equal to 0.001 inches. In the context of the illustrations in this section, a mil represents the minimum bar code element width. Thus a 5 mil bar code would have a minimum element width of 5 mils (or 0.005 inches).

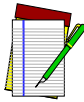

#### NOTE

Measurements are based on SR models set with the standard 28° scan width (as opposed to the Half Angle setting of 14°). Reference the Programming Manual for more information about the Half Angle feature.

Specifications are subject to change without notice.

Figure 7. Depth of Field (SR)

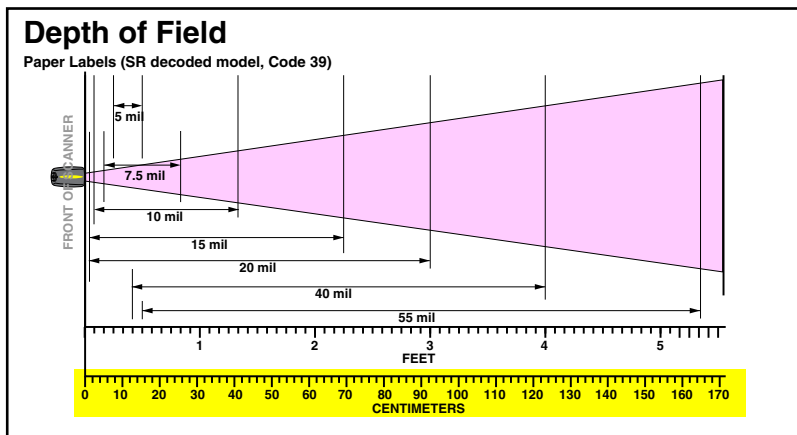



**NOTE**

See the section titled, *Definition of a "mil"* for more information about reading this chart. Measurements are based on HD models set with the standard 28° scan width (as opposed to the Half Angle setting of 14°). Reference the Programming Manual for more information about the Half Angle feature.

Specifications are subject to change without notice.

**Figure 8. Depth of Field (HD)**

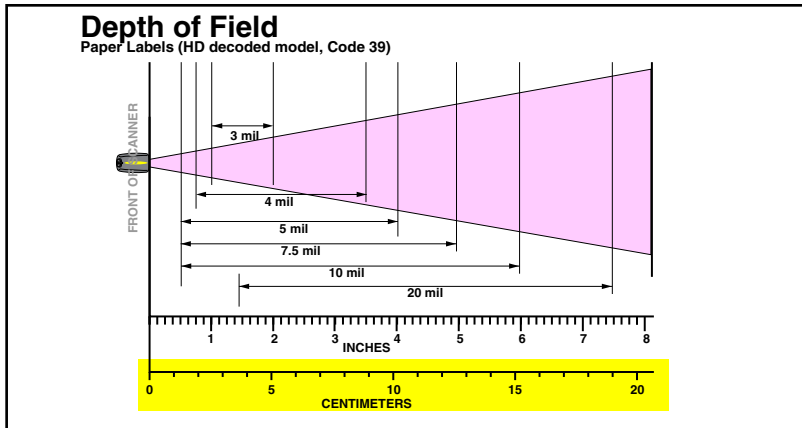

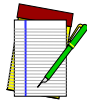

See the section titled, *Definition of a "mil"* for more information about reading this chart. Measurements are based on LR models set with the 14° scan width (as opposed to the alternate Full Angle setting of 28°). Reference the Programming Manual for more information about the Half Angle feature.

**NOTE**

Specifications are subject to change without notice.

**Figure 9. Depth of Field (LR)**

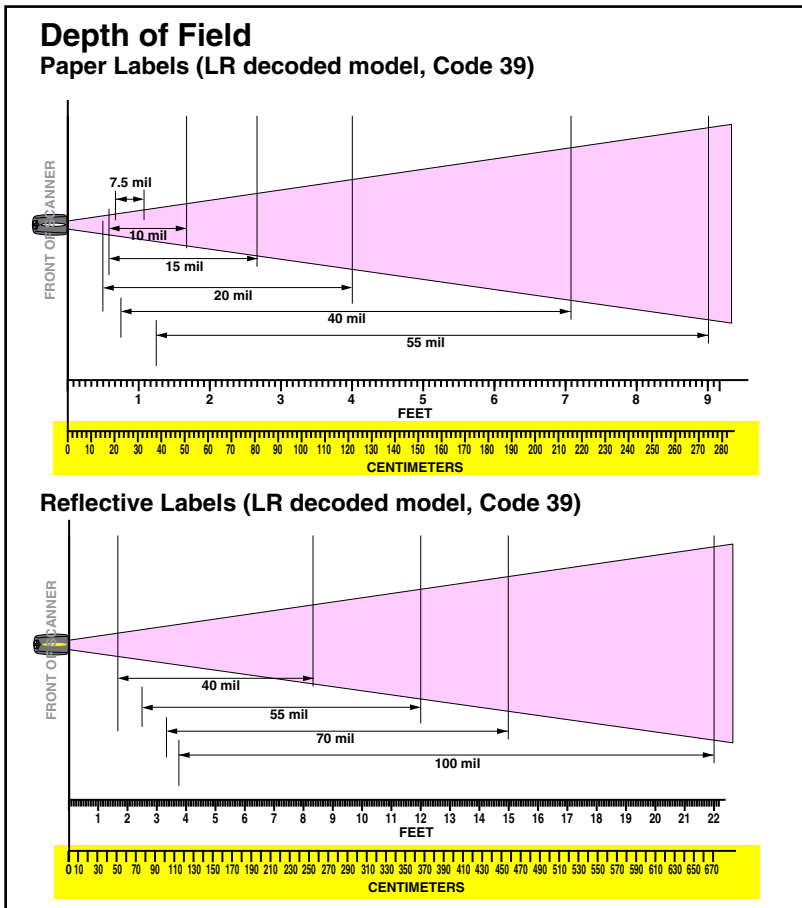





See the section titled, *Definition of a "mil"* for more information about reading this chart. Measurements are based on XLR models set with a 10° scan angle width.

**NOTE**

Specifications are subject to change without notice.

**Figure 10. Depth of Field (XLR)**

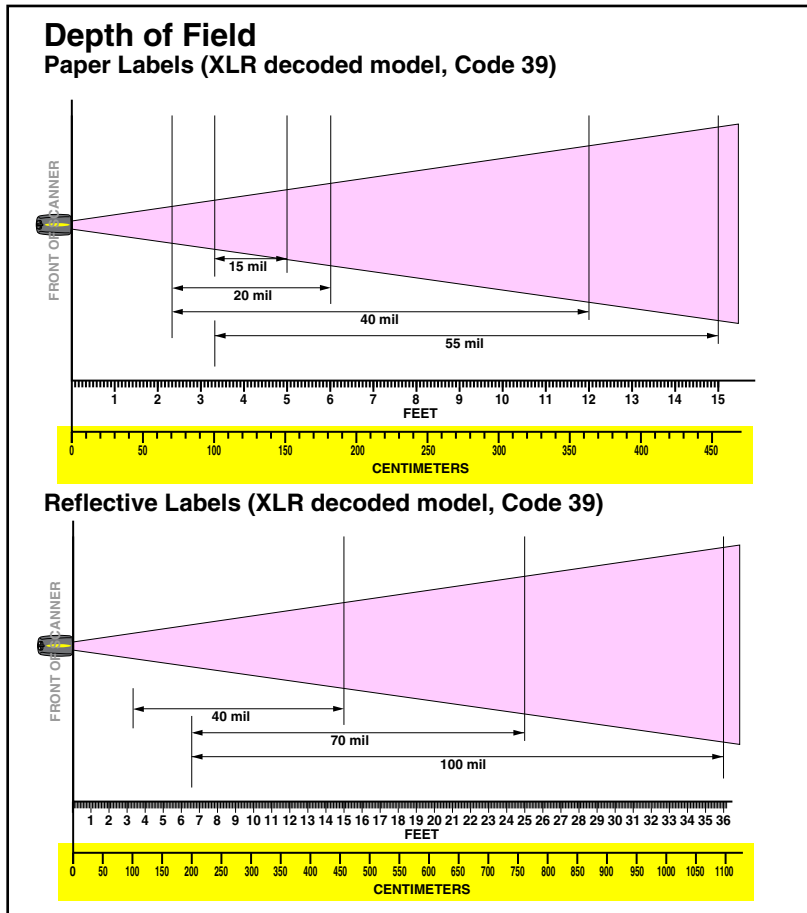

## LED and Beeper Indications



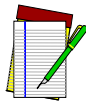

The Base Station LED indicators and the scanner's LEDs and beeper are used to announce system status and perform other useful signals. The tables below list the default function of each of the various indicators.

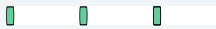

### NOTE

Some LED and beeper indications can be disabled or modified via scanner programming. The tables indicate the default behavior of the indicators, with shaded rows representing features that are programmable.





**Table 1. Scanner GREEN LED Functions**





LED INDICATION	DURATION	COMMENT
Disable Indication	100ms on, 900 ms off 	Indicates the scanner has been disabled.
Good Read Indication	500 ms on 	Indicates a bar code has been read and decoded.
Program Mode Indication	500 ms on, 500 ms off Continuous flashing 	Indicates the scanner is in Programming Mode.
Field Replaceable Unit (FRU) Indications	Varies. Consists of a long flash followed by multiple short flashes. 	Enables service technicians to identify Field Replaceable Unit (FRU) errors.
Low Battery Indication	Two flashes at 100 ms on, 350 ms off. 	Occurs at trigger pull before the laser is enabled. Indicates the battery is in need of recharging.

**Table 2. Scanner YELLOW LED Functions**



LED INDICATION	DURATION	COMMENT
Laser on indication	On Steady 	The yellow LED illuminates whenever the laser is on.



**Table 3. Scanner BEEPER Functions**

SPEAKER INDICATION	DURATION	COMMENT
Scanner Not Currently Linked	Six beeps consisting of 20 ms on, 20 ms off 	Indicates a bar code was read before the scanner was linked to a Base Station.
Good Read Beep	100 ms on (short)   250 ms on (medium)  500 ms on (long) 	Three programmable functions are available. This indicates a bar code has been read and decoded.
Partial Read Bip	20 ms on 	A very short beep ("bip") is sounded when one bar code of a two-bar code pair has been successfully decoded.
Base Station Acknowledgment Beep	100 ms on (short)   250 ms on (medium)  500 ms on (long) 	Indicates a successful bar code transmission to the host (configurable), a successful change of channel, or a successful transmission of a new configuration to the host.

SPEAKER INDICATION	DURATION	COMMENT
Transmission Error Beep	High, then low, then high, then low. 	Indicates unsuccessful transmission to the host.
Link Beep	Low, then medium, then high. 	Indicates a scanner has been successfully linked to a base station.
Unlink Beep	High, then medium, then low. 	Indicates a scanner has been successfully unlinked from a base station.
Field Replaceable Unit (FRU) Indications	Varies. Consists of a long tone followed by multiple short tones. 	Enables service technicians to identify Field Replaceable Unit (FRU) errors.

**Table 4. Base Station LED Functions**

LED INDICATION	DURATION	COMMENT
TX/RX (Transmit/Receive)	Lit for variable time <sup>a</sup> 	Indicates communications activity to or from the Base Station.
	Continuous rapid flashing at power-up 	Indicates a broken radio.
	Varies. Consists of a long flash followed by multiple short flashes. 	Enables service technicians to identify Field Replaceable Unit (FRU) errors.

LED INDICATION	DURATION	COMMENT
Charge (Battery)	Continuous flashing 	When a scanner is nested in the station, this indicates its battery is being quick charged.
	Lit Constantly 	When a scanner is nested in the station, this indicates its battery is at or near full charge.
	Not Lit	A scanner is not present or incorrectly inserted into the station. It can also mean the battery is below 0°C (too cold for charge)
Power	Lit Constantly 	Indicates that power is on.

- a. The LED remains on while the unit is actively processing code which requires a TX/RX to occur. The duration of the LED is dependent upon the length of the message.

### Active Symbolologies

The active (enabled) bar code symbolologies in the standard factory defaults are:

- Code 39 (C39)
- Code 128 (C128)
- Interleaved 2 of 5 (I 2 of 5)

Your scanner should be pre-programmed with these standard factory default settings, unless...

...it was shipped to you programmed with unique, customer configuration settings.

...you or another user have made changes to scanner programming.

## Enhanced Scanning for Hard-to-Read Bar Codes

Decoded scanners can be programmed to decode extremely poor quality bar codes by activating advanced Quadralogic II™ Decoding. To select this feature, see the Programming Guide.

Scanner programming can also be performed using your PC and the Configurator Express™ On-Screen Programming Kit.

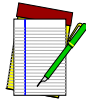

### NOTE

Information about manuals, kits and programming software for this product are available at our web-site. See the back cover for our web address.

Figure 11. Scanner Labeling and Nomenclature

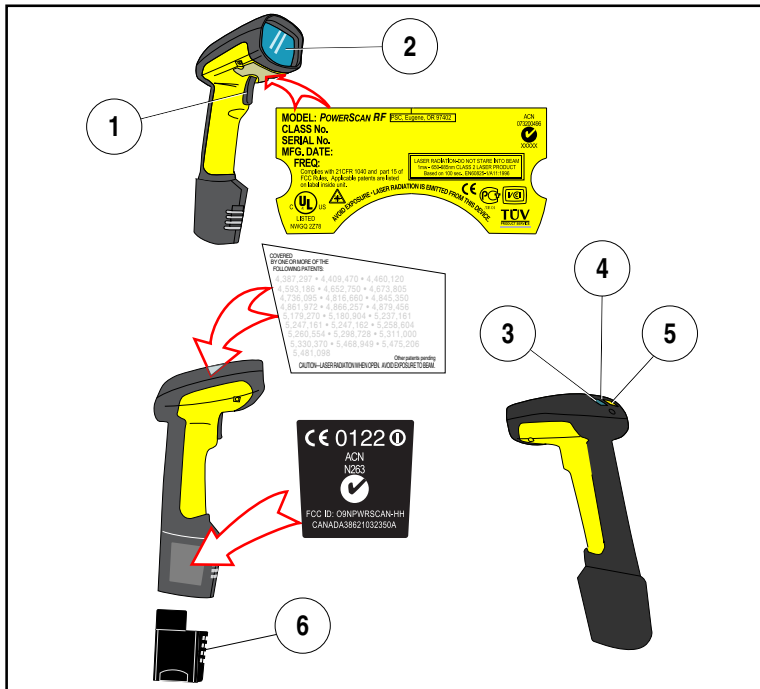

- |                |                |
|----------------|----------------|
| 1. Trigger     | 4. Tether Hook |
| 2. Scan Window | 5. Yellow LED  |
| 3. Green LED   | 6. Battery     |

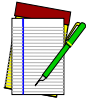

**NOTE**

Figure 11 above shows label placement **ONLY**. For actual regulatory, patent and other applicable information, view the labels on the product itself, or call your nearest sales or service representative.

## Laser Cautions

The PowerScan RF bar code scanner is certified in the U.S. to conform to the requirements of *DHHS/CDRH 21CFR Subchapter J for Class II laser products (SR and LR) and Class IIIa (XLR)*. Class II and IIIa products are not considered to be hazardous. The scanner contains a Visible Laser Diode (VLD) at a wavelength of 650-670 nanometers and is designed so that there can be no human access to harmful levels of laser light during normal operation, user maintenance, or during prescribed service operations.



**CAUTION**

In the unlikely event that a bright laser spot is experienced rather than a scan line, do not stare into the beam or attempt to repair the unit. Discontinue operation and return the unit to your dealer. Note that when using Marker Beam Mode, a single aiming dot is projected momentarily preceding a scan line and is not considered a malfunction.



**CAUTION**

Do not open or otherwise service any components in the optics cavity. Opening or servicing any part of the optics cavity by unauthorized personnel may violate laser safety regulations. The optics system is a factory only repair item.



**NOTE**

The PowerScan® RF scanner is required to be used in conjunction with the Datalogic Base Station, Model: PowerScan RF Base Station.

---

---

## Radio Frequency Interference

This device complies with Part 15 of the FCC Rules. Operation is subject to the following two conditions:

1. This device may not cause harmful interference, and
2. This device must accept any interference received, including interference that may cause undesired operation.

This Class A digital apparatus complies with Canadian ICES-003.

Cet appareil numérique de la classe A est conforme à la norme NMB-003 du Canada.

This equipment has been tested and found to comply with the limits for a Class B digital device, pursuant to Part 15 of the FCC Rules. These limits are designed to provide reasonable protection against harmful interference in a residential installation. This equipment generates, uses and can radiate radio frequency energy and, if not installed and used in accordance with these instructions, may cause harmful interference to radio communications. However, there is no guarantee that interference will not occur in a particular installation. If this equipment does cause harmful interference to radio or television reception, which can be determined by turning the equipment off and on, the user is encouraged to try to correct the interference by one or more of the following measures:

- Reorient or relocate the receiving antenna.
- Increase the separation between the equipment and receiver.
- Connect the equipment into an outlet on a circuit different from that to which the receiver is connected.
- Consult the dealer or an experienced radio/TV technician for help.



---

## Maintenance

The scan window will require occasional cleaning to remove smudges, dust and other debris. To ensure optimal performance, clean the Scan Window using a soft cloth or lens tissue dampened with isopropyl alcohol (or equivalent). See Figure 12. The scanner body can also be cleaned using this method.

**Figure 12. Cleaning the Scan Window**

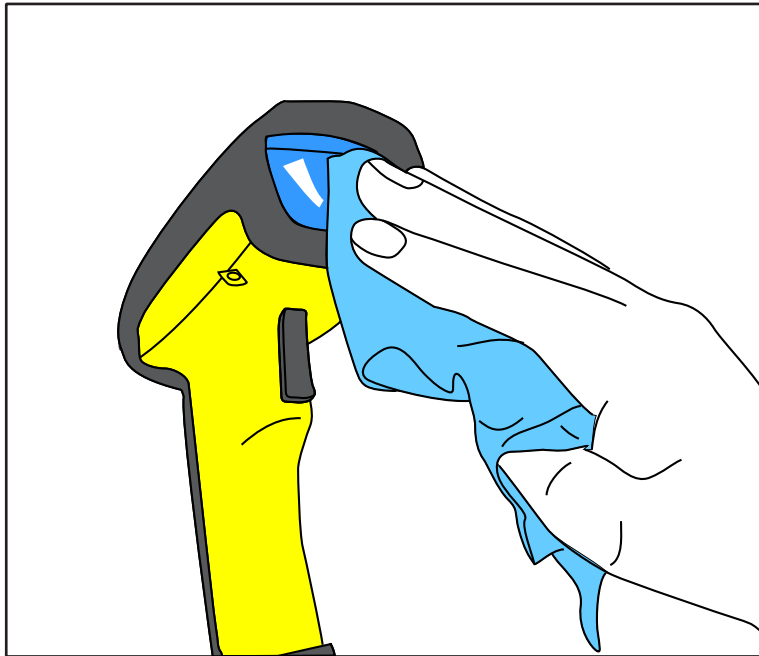

---

---

## Troubleshooting

Troubleshoot your RF scanning system by performing the following checks:

For the RF system, ensure that...

- the battery is charged. See “Battery Charging and Maintenance” on page 10.
- the battery is properly installed. See “Installing the Battery” on page 4.
- the scanner is linked to the desired Base Station. See “Linking the Scanner to a Base Station” on page 7.
- the scanner is within reasonable operating range of the Base Station, with no major obstructions between the radio units such as thick walls or heavy machinery. (At the time of this writing, maximum line-of-sight range is specified at 150 feet.)
- there is no local signal interference with other radio-operated equipment. Consult the Systems Manual concerning selection of alternate channels.
- the Base Station is powered-on. You can verify the Base Station’s AC Adapter by using a known-good AC Adapter.
- the Base Station interface cable is securely attached to the host. Consult your technical support manager or refer to your host system manual to identify the proper cable connection for the scanner. If necessary, verify interface cable function by using a known-good interface cable.

If the problem is specific to scanning, verify that...

- the bar codes you are trying to scan are of satisfactory quality. Bar code label verifiers are available from your dealer if you need precise reporting of label details. Bar codes that are damaged (wrinkled, smudged, or torn) may cause the scanner to read poorly or not at all. If bar code quality seems to be the problem, check to see if the scanner will read a sample bar code from the following pages.
- the programmable setting for advanced Quadralogic II™ decoding is set optimally for your system. (See “Enhanced Scanning for Hard-to-Read Bar Codes” on page 22.)

---

## Sample Bar Codes

Use these test bar codes to check the scanner's ability to read the various symbologies represented.

Code 128



Code 39



Interleaved 2 of 5



Standard 2 of 5



Codabar



Code 93



MSI/Plessey



14476925 4

UPC-A



0 00112 23344 0

UPC-A with 2 digit Add-on



0 60992 01118 7 4 9

UPC-A with 5 digit Add-on



0 08029 51041 8 6 9 0 0 0

UPC-E



0 998875 0

EAN-8



0021 0126

EAN-13



1 101234 567891

---

---

## DEUTSCHES INHALTSVERZEICHNIS

Auspacken und Überprüfen Ihres Scanners .....	31
Referenzen .....	31
Anweisungen für den Schnellstart .....	31
Einlegen der Batterie .....	32
Überprüfen des Scannerbetriebes .....	33
Netzteil .....	33
Anschließen der Basisstation an das Hauptterminal .....	33
Verbinden des Scanners mit der Basisstation .....	35
Prüfen der Verbindung Scanner-an-Basisstation .....	37
Anwenden des PowerScan RF-Systems .....	38
Batterieaufladung und Wartung .....	38
Tipps zur Verlängerung der Batteriehaltbarkeit .....	39
Entsorgung der Batterien .....	39
Vier-Stationen-Ladegerät .....	40
Wie wird gescannt .....	41
Feldtiefe .....	42
LED- und Signal-Anzeigen .....	46
Aktive Symboliken .....	50
Erweitertes Scannen für schlecht lesbare Barcodes .....	50
Warnhinweise für Laseranwendung .....	52
Hochfrequente Störungen .....	53
Wartung .....	54
Fehlersuche .....	55
Muster-Barcodes .....	57

---

## **Datalogic Scanning Inc.**

959 Terry Street  
Eugene, Oregon 97402  
Tel.: (541) 683-5700  
Fax: (541) 345-7140

Datalogic, das Datalogic-Logo, Quadralogic II und PowerScan sind eingetragene Warenzeichen der Datalogic Scanning, Inc. Alle anderen hier genannten Warenzeichen und Handelsnamen sind Eigentum der jeweiligen Besitzer.

Alle Rechte vorbehalten. Ohne die vorherige schriftliche Zustimmung der Datalogic Scanning, Inc. dürfen keine Inhaltsabschnitte dieser Dokumentation oder der hier beschriebenen Verfahren in irgendeiner Form oder mit irgendwelchen Mitteln vervielfältigt oder übertragen werden. Den Eigentümern von Produkten der Datalogic Scanning, Inc. wird hiermit eine nicht ausschließliche, widerrufliche Lizenz zur Vervielfältigung und Übertragung dieser Dokumentation gewährt, die nur für die internen Geschäftszwecke des Käufers gilt. Der Käufer ist nicht berechtigt, die in dieser Dokumentation enthaltenen Hinweise des Eigentümers, einschließlich der Copyright-Hinweise, zu entfernen oder zu ändern, und er gewährleistet, dass alle Hinweise auf jeglichen Vervielfältigungen der Dokumente erscheinen.

Wenn zukünftig Überarbeitungen dieses Handbuches herausgegeben werden, können Sie die gedruckten Versionen über die Datalogic Kundenverwaltung erhalten. Die elektronischen Versionen können entweder von der Datalogic-Webseite ([www.scanning.datalogic.com](http://www.scanning.datalogic.com)) heruntergeladen werden oder Ihnen auf einem entsprechenden Medium geschickt werden. Wenn Sie unsere Webseite besuchen und zu dieser Webseite oder anderen Datalogic-Veröffentlichungen Ihren Kommentar oder Vorschläge abgeben möchten, dann ist dies über die Seite "Contact Datalogic" möglich.

### **Haftungsausschluss**

Es wurden angemessene Maßnahmen ergriffen, damit die in diesem Handbuch enthaltenen Informationen vollständig und korrekt sind. Datalogic behält sich jedoch das Recht vor, Spezifikationen ohne vorherige Mitteilung und zu jeder Zeit zu ändern.

---

## Auspacken und Überprüfen Ihres Scanners

Nachdem Sie Ihren neuen Scanner ausgepackt haben, überprüfen Sie den Inhalt des Lieferkartons, ob auch alle von Ihnen bestellten Teile geliefert wurden:

- PowerScan® RF Handscanner
- Batterie/n
- Benutzerhandbuch (dieses Handbuch)
- zusätzliches Zubehör, das Sie bestellt haben. (Der Scanner kann mit oder ohne Zubehör-Kit bestellt werden)

Wenn Ihr Paket falsche Teile enthält oder wenn Teile fehlen, wenden Sie sich bitte an Ihre Verkaufsstelle. Wenn beschädigte Teile enthalten sind, dann legen Sie umgehend Ihre Forderung dem Frachtunternehmen vor. Bewahren Sie das Verpackungsmaterial auf, falls Sie den Scanner zu einem späteren Zeitpunkt versenden möchten.

## Referenzen

Weitere Informationen zu diesem Produkt, zu darauf bezogenen Veröffentlichungen, Software und Zubehör erhalten Sie auf unserer Webseite, die auf der Rückseite dieses Handbuches angegeben ist.

## Anweisungen für den Schnellstart

Die nachfolgenden Grundschrirte müssen ausgeführt werden, um den RF-Scanner in Betrieb zu nehmen. Jeder dieser Schritte ist ausführlich in diesem Handbuch beschrieben.

- Einlegen der Batterie
- Überprüfen des Scannerbetriebes
- Anschließen der Basisstation an das Hauptterminal
- Verbinden des Scanners mit der Basisstation
- Prüfen der Verbindung Scanner-an-Basisstation

## Einlegen der Batterie



### Hinweis

Für eine maximale Lebensdauer sollten die Batterien vor der ersten Anwendung immer vollständig aufgeladen sein. (Siehe "Batterieaufladung und Wartung" auf Seite 38).

Richten Sie die Batterie wie in Abbildung 1 gezeigt aus und drücken Sie die Batterie dann so weit in den Scanner, bis sie einrastet. Die Batterie wird herausgenommen, indem Sie auf die Lösetasten an beiden Seiten des Batterieteils drücken und die Batterie gerade aus dem Scanner herausziehen.

**Abbildung 1: Einlegen der Batterie**

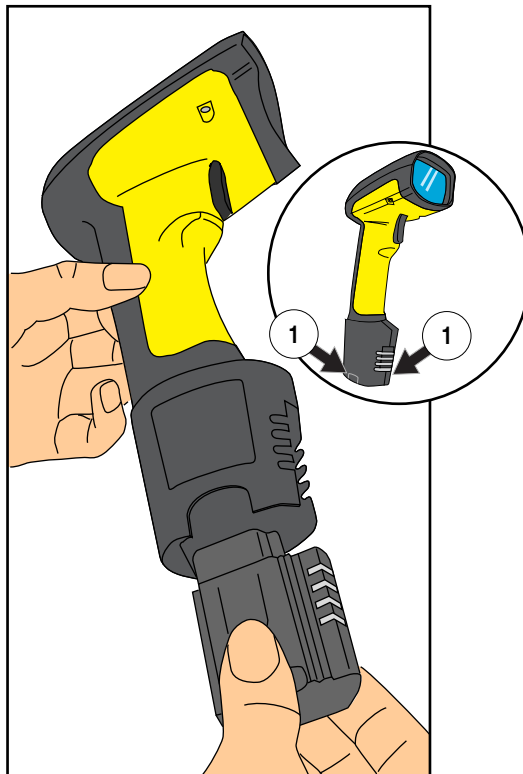

1. Batterie-Lösetasten



## Überprüfen des Scannerbetriebes

Sobald die aufgeladene Batterie in den Scanner eingelegt wurde, scannen Sie jene Muster-Barcodes auf den letzten Seiten dieses Handbuches, die der Symbolik entsprechen, für die Ihr Scanner programmiert ist. Wenn Sie sich über die Vorgehensweise unsicher sind, lesen Sie den Abschnitt dieses Handbuches "Wie wird gescannt". Das System kann ein Signal an einer oder an einer Kombination von Anzeigen abgeben, dies ist abhängig von der Antwort-Programmierung des Scanners und der Basisstation (siehe "LED- und Signal-Anzeigen" für weitere Erklärungen). Wenn Ihr Scanner nicht einen Muster-Barcode der Symbolik lesen kann, für die er programmiert ist, lesen Sie den Abschnitt "Fehlersuche".

## Netzteil

Die Modelle erfordern eine Stromquelle der Klasse II oder III mit einer Leistungsbegrenzung (LPS).

Für eine gültige Sicherheitszertifizierung müssen Klasse III Stromquellen am Eingang nach den Bestimmungen IEC/EN60950-1 (EN 60335-Serien, EN 60065 oder entsprechenden) zugelassen sein.

Eingang: 100 - 240 VAC      Ausgang: 9 - 10 VDC

Max. Strom: 2.0 A              Max. Leistung: 20 W

Für 4-fach Batterieladegerät

Eingang: 100 - 240 VAC      Ausgang: 12 VDC

Max. Strom: 2.5 A              Max. Leistung: 30 W

## Anschließen der Basisstation an das Hauptterminal



### Hinweis

**Vor dem Anschließen an das Stromnetz muss das Schnittstellenkabel (I/F) an die Basisstation angeschlossen werden. Das ist deshalb wichtig, weil der Schnittstellentyp (RS-232, IBM, Keyboard Wedge, usw.) von der Basisstation über das I/F-Kabel gewählt wird, an dem sie zum Zeitpunkt der Stromzufuhr angeschlossen ist.**

1. Schließen Sie das I/F-Kabel an die Basisstation an (siehe Abbildung 2A). Das I/F-Kabel wird in den Anschlussstecker eingeführt und die Kabelrückhalteklammer wird so weit über die Kabel-Überform gedreht, bis der Rückhalter einrastet (siehe Abbildung 2B). Um das Kabel zu lösen, drücken Sie den Rückhalter zum Lösen ein (von der Sperre an der Kunststoffwand weg), damit er nach oben schwingen kann und das Kabel frei liegt (Abbildung 2C).

## Abbildung 2 Anschließen/Trennen des Schnittstellen-(I/F)Kabels

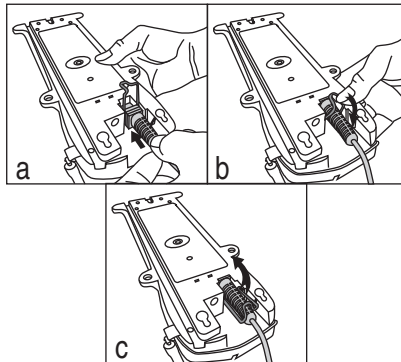

2. Lesen Sie im Hauptterminal-Handbuch die erforderlichen Kommunikationsparameter für das Hauptterminal nach (z.B. Baud-Rate, Parität, usw.) und ändern Sie falls erforderlich die programmierten Parameter, damit diese mit den Anforderungen übereinstimmen. Die Programmierung des Scanners und der Basisstation wird mit einem der folgenden Mittel ausgeführt:

- Configurator Express™ Programming Software
- PowerScan® Bar Code Scanner Programming Guide



**Hinweis**

**Siehe "Referenzen" für weitere Einzelheiten dazu, wie Sie die Software und Handbücher für dieses Produkt erhalten.**



**Achtung**

**Im Hauptterminal-Handbuch muss nachgeschlagen werden, ob der Netzstrom vor dem Anschluss der Peripheriegeräte abgeschaltet sein muss. Vergewissern Sie sich, dass das richtige Verfahren eingehalten wird, damit Schäden an der Ausrüstung oder eine Unterbrechung der Systemfunktionen vermieden werden.**

3. Schließen Sie das I/F-Kabel an den richtigen Anschlussstecker des Hauptterminals an (lesen Sie im Hauptterminal-Handbuch den Abschnitt zu Hardwareanforderungen).

- Schließen Sie das Stromkabel des AC-Adapters an die Basisstation an und stecken Sie den AC/DC-Adapter in die Wandsteckdose (siehe Abbildung 3). Die Strom-LED der Basisstation leuchtet, wenn die Einheit korrekt an das Stromnetz angeschlossen ist.

### Abbildung 3: Die Basisstation mit dem Stromnetz verbinden

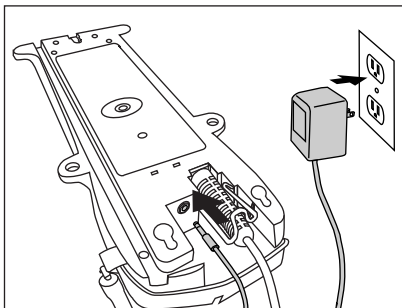

- Schalten Sie den Strom für das Hauptterminal an.
- Prüfen Sie die Kommunikation mit dem Hauptterminal, in dem Sie den verbundenen Scanner auf einen Muster-Barcode der letzten Seiten dieses Handbuchs halten und den Auslöser ziehen (für Tipps über das Scannen von Barcodes siehe "Wie wird gescannt"). Prüfen Sie, ob der Scanner/die Basisstation die Daten zum Hauptterminal sendet. Wenn nicht, siehe Abschnitt "Fehlersuche". Sobald alle Kommunikationen überprüft sind, ist das System betriebsbereit.

### Verbinden des Scanners mit der Basisstation

Der Scanner wird mit der Basisstation verbunden, indem einfach der ID-Barcode für die Basisstation gescannt wird, den Sie oben auf der entsprechenden Basisstation finden. Während der Scanner die Basisstation sucht, hören Sie einen kurzen Signal, der die Kanalsuche anzeigt. Wenn die Basisstation auf die Suche reagiert, dann ändert sich der Signalton des Scanners zu einem Signal "Verbindung gewährt" oder "Verbindung verweigert" (für weitere Informationen siehe Abschnitt "LED- und Signal-Anzeigen").

---

Die bestehende Systemkonfiguration der Basisstation kann automatisch auf den Scanner übertragen werden. Dieses Merkmal der automatischen Übertragung kann konfiguriert und abgestellt werden. Für weitere Informationen zu diesem Merkmal siehe Systemhandbuch. Bei einer Übertragung tritt eine leichte Verzögerung der Anzeige der Verbindungsüberprüfung auf.



**Achtung**

Da ein neuer/Austausch-Scanner mit einer Kundenkonfiguration geliefert oder mittels einer anderen speziellen Programmierung geändert sein kann, ist das Downloaden einer möglicherweise älteren Konfiguration von einer bestehenden Basisstation nicht empfehlenswert. In diesem Fall ist es ratsam, über das Systemhandbuch oder die Configurator Express™ On-Screen Programming Software die neuere Konfiguration des Scanners vor der Verbindung auf die Basisstation zu übertragen.

---

## Prüfen der Verbindung Scanner-an- Basisstation

Halten Sie den verbundenen Scanner auf einen Muster-Barcode der letzten Seiten dieses Handbuches und ziehen Sie den Auslöser (für Tipps zum Scannen von Barcodes siehe "Wie wird gescannt"). Während Sie den Barcode scannen, beobachten Sie die LED-Anzeige TX/RX (übertragen/empfangen) auf der Basisstation und/oder die grüne LED am Scanner. Die LEDs sollten vorübergehend aufblinken, wenn die beiden Geräte miteinander in Verbindung sind. Wird keine Kommunikation angezeigt, dann lesen Sie den Abschnitt "Fehlersuche" im Systemhandbuch.

Sofern der Scanner darauf programmiert ist, wird die Kommunikation auch durch einen zweiten "Bestätigungston" angezeigt, der nach dem "Übertragung-gut"-Ton ertönt<sup>1</sup>. Wenn der Signal für eine fehlerhafte Übertragung (Wobbelton) nach einem "Übertragung-gut"-Ton zu hören ist anstelle eines einzigen Bestätigungstons, dann ist die Kommunikation zwischen den Geräten möglicherweise nicht zustande gekommen<sup>2</sup>. Wenn dieser Fall auftritt, versuchen Sie mit Hilfe der Abschnitte "Anwenden des PowerScan RF-Systems" und "Fehlersuche" das Problem zu beheben.

- 
1. Für weitere Einzelheiten über Signal siehe "LED- und Signal-Anzeigen"
  2. Andere Gründe für einen "Wobbelton" sind, dass die Basisstation möglicherweise anders als der Scanner konfiguriert ist oder dass die Systemschnittstelle nicht die Symbolik unterstützt (Barcode-typ), die Sie versuchen einzuscannen.

## Anwenden des PowerScan RF-Systems

Dieser Abschnitt behandelt die folgenden Punkte:

- Batterieaufladung und Wartung
- Wie wird gescannt
- LED- und Signal-Anzeigen

### Batterieaufladung und Wartung



Hinweis

Wenn der Scanner in Betrieb ist, wird über ein wiederholtes zweimaliges Blinksignal der grünen LED des Scanners jedes Mal ein niedriger Batteriezustand angezeigt, wenn der Auslöser vor der Aktivierung des Lasers gezogen wird. Diese Anzeige kann über die Kundenprogrammierung abgestellt worden sein. Für weitere Informationen siehe "LED- und Signal-Anzeigen".

Legen Sie den Scanner wie in Abbildung 4 gezeigt in die Basisstation und vergewissern Sie sich, dass die Batterie vollständig mit den Metallkontakten der Station eingerastet ist. Die Aufladungs-LED an der Basisstation sollte jetzt blinken und damit anzeigen, dass die Batterie aufgeladen wird.

**Abbildung 4: Aufladung der Batterie**

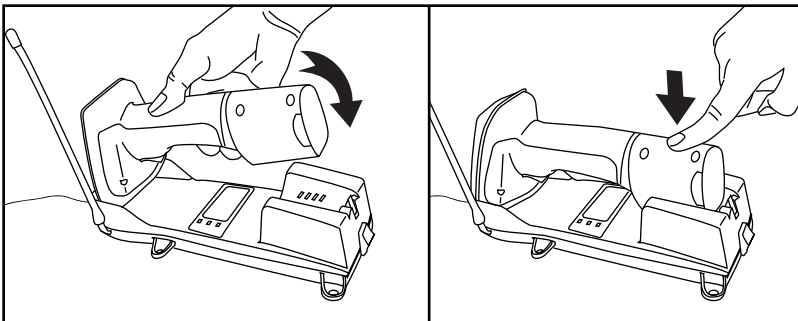

---

Ein schnelles Blinken zeigt an, dass das Aufladen stattfindet. Ein schnelles Aufladen erfolgt, wenn die Batterietemperatur zwischen 10°C (50°F) und 46°C (115°F) liegt, und/oder die Batteriespannung zwischen 2,0 und 3,2 V liegt. Die Ladezeit beträgt weniger als 4,2 Stunden. Die schnelle Aufladung wird bei einer 90 bis 95%-igen Batterieleistung abgeschlossen. Die Aufladungs-LED leuchtet kontinuierlich, wenn die Batterie langsam aufgeladen wird oder wenn der Ladezyklus abgeschlossen ist.



**Hinweis**

**Ein Scanner kann gleichzeitig geladen werden, während andere Scanner mit der Basisstation in Betrieb sind.**



**Hinweis**

**Batterien laden sich unterhalb einer Temperatur von 0°C (30°F) nicht auf. Wenn eine zu kalte Batterie in eine Basisstation gelegt wird, dann leuchtet die Lade-LED nicht auf.**

### **Tipps zur Verlängerung der Batteriehaltbarkeit**

Nickel-Metall-Hydrid-(NiMH)Batterien halten länger, wenn sie wenigstens einmal pro Woche entladen werden. Die chemischen Reaktionen, die bei einer wiederaufladbaren Batterie einem Auf- und Entladen entsprechen, sollten auftreten, um die maximale Anzahl der Auf-/Entladungszyklen der Batterie zu erzielen. Wenn eine Batterie aus dem Scanner genommen und gelagert wird, dann sollte sie für die Lagerung vollständig aufgeladen sein. Batterien verlieren durch lange Lagerzeiten (Wochen, Monate oder länger) ihre Fähigkeit, einen Ladezustand beizubehalten.

Bei der Lieferung sind die Batterien in der Regel zu 30% geladen. Um eine maximale Nutzung zu garantieren, sollte die Batterie vor der Anwendung vollständig aufgeladen sein.

Lagern Sie die Batterie an einem kühlen und trockenen Ort. Setzen Sie die Batterie niemals der direkten Sonnenbestrahlung oder Temperaturen unterhalb von 0°C (30°F) und über 38°C (100°F) aus.

### **Entsorgung der Batterien**

Derzeit bestehen keine Entsorgungsanforderungen für NiMH-Batterien in den Vereinigten Staaten, Nordamerika oder weltweit. Wenn die Batterien also nicht mehr die Ladung halten, dann können sie vorzugsweise über eine Recyclingzentrale entsorgt werden.

## Vier-Stationen-Ladegerät

Wenn Sie über ein Vier-Stationen-Ladegerät verfügen, dann werden die Batterien zur Aufladung wie in Abbildung 5 gezeigt eingelegt. Eine 90%-ige Aufladung wird in nur zwei Stunden erzielt, wenn dieses zusätzliche Zubehör verwendet wird - dass entspricht der Hälfte der Zeit, die für eine Aufladung über die Basisstation erforderlich ist. Die LEDs an jeder Batteriestation funktionieren auf die gleiche Weise wie die Aufladungs-LED an der Basisstation: ein schnelles Blinken zeigt eine schnelle Aufladung an, und ein kontinuierliches Leuchten zeigt eine langsame Aufladung oder die Beendigung eines schnellen Aufladungszyklus an.



### Hinweis

Wenn Sie eine Batterie in ein Vier-Stationen-Ladegerät einlegen und keine LED aufleuchtet, dann kann die Batterie zu kalt sein. Batterien benötigen für eine Aufladung Temperaturen von 0°C oder höher. Versuchen Sie nicht eine kalte Batterie aufzuladen. Sobald Sie eine kalte Batterie in das Ladegerät einlegen, wird das Aufladen der anderen Batterien verkürzt, die sich bereits in der Einheit befinden.

Abbildung 5: Anwenden des Zubehörs Vier-Stationen-Ladegerät

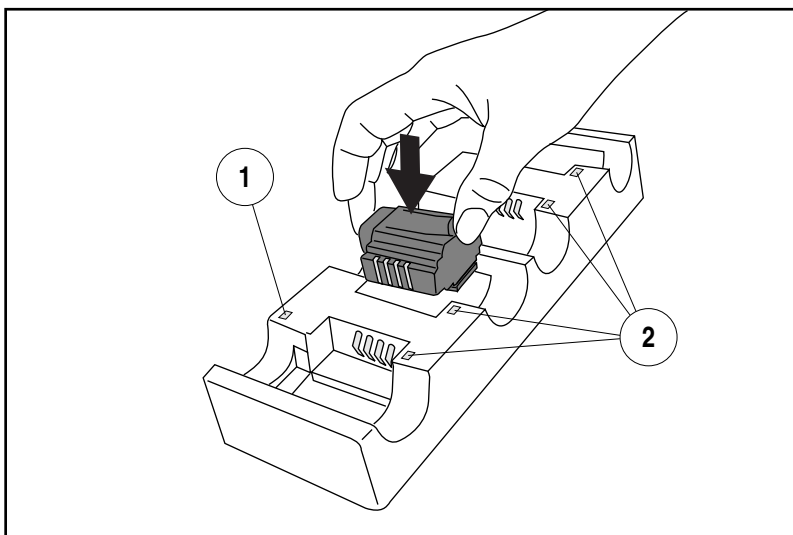

1. Power-LED des Gerätes

2. Ladungs-LEDs der Station



## Wie wird gescannt

Abbildung 6 zeigt einige Tipps, wie Sie die besten Ergebnisse beim Scannen erzielen können:

1. Der Scanner muss mit einem kleinen Winkel zum Barcode gehalten werden.
2. Der Laserstrahl muss den gesamten Barcode überqueren. Der Scanner kann nicht korrekt einlesen, wenn nicht der gesamte Barcode gescannt wird.

**Abbildung 6: Tipps zum Scannen**

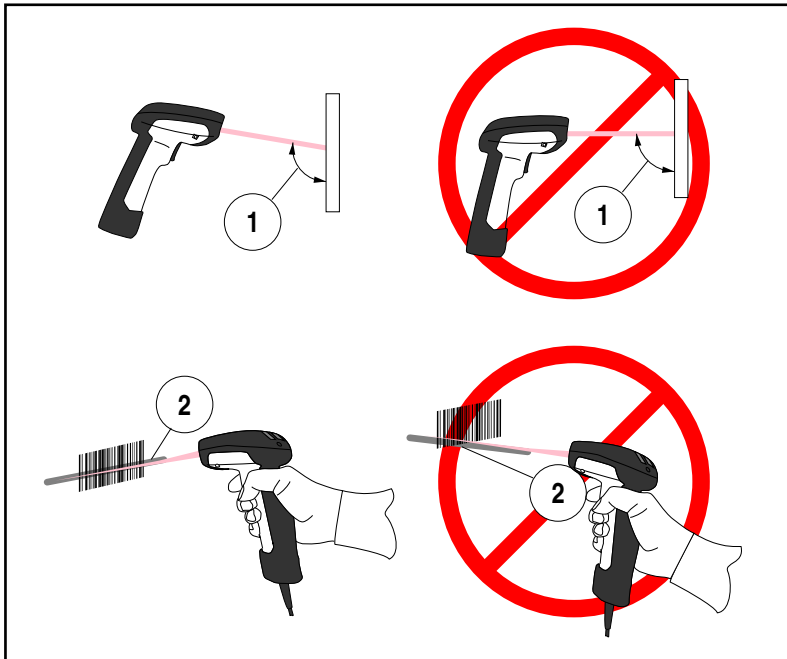

**Feldtiefe** Derzeit gibt es für den Scanner vier verschiedene Reichweitenmodelle. Abhängig vom Modelltyp Ihres Scanners, müssen Sie die Einheit mit einem bestimmten Abstand vom Barcode halten, um ein optimales Ergebnis beim Scannen zu erzielen. Die folgenden Diagramme geben die Feldtiefen für jedes der Modelle an, wenn Barcodes von Grad A, Code 39 gescannt werden: Standardreichweite (SR), hohe Dichte (HD), große Reichweite (LR) und extra große Reichweite (XLR).

**Definition eines "Mil"** Ein "Mil" ist gleich 0,001 Inch. Im Zusammenhang mit den Abbildungen aus diesem Abschnitt stellt ein Mil die minimale Barcode-Elementbreite dar. Somit hätte ein 5-Mil-Barcode eine minimale Elementbreite von 5 Mil (oder 0,005 Inch).



**Hinweis**

Die Messungen basieren auf den Einstellungen der SR-Modelle mit der standardmäßigen 28° Scanbreite (im Gegensatz zu der Halbwinkelstellung von 14°). Für weitere Informationen über Halbwinkelmerkmale siehe "Programmierhandbuch".

Diese Spezifikationen können Änderungen ohne vorige Mitteilung unterliegen.

**Abbildung 7: Feldtiefe (SR)**

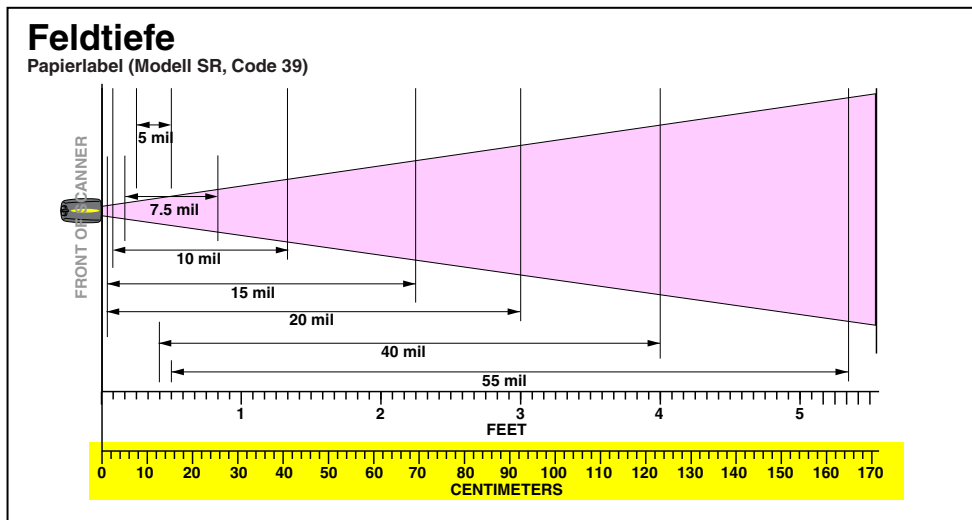

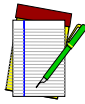

#### Hinweis

Für weitere Informationen zu diesen Diagrammen siehe Abschnitt "Definition eines "Mil"". Die Messungen basieren auf den Einstellungen der HD-Modelle mit der standardmäßigen 28° Scanbreite (im Gegensatz zu der Halbwinkelseinstellung von 14°). Für weitere Informationen über Halbwinkelmerkmale siehe "Programmierhandbuch".

Diese Spezifikationen können Änderungen ohne vorige Mitteilung unterliegen.

Abbildung 8: Feldtiefe (HD)

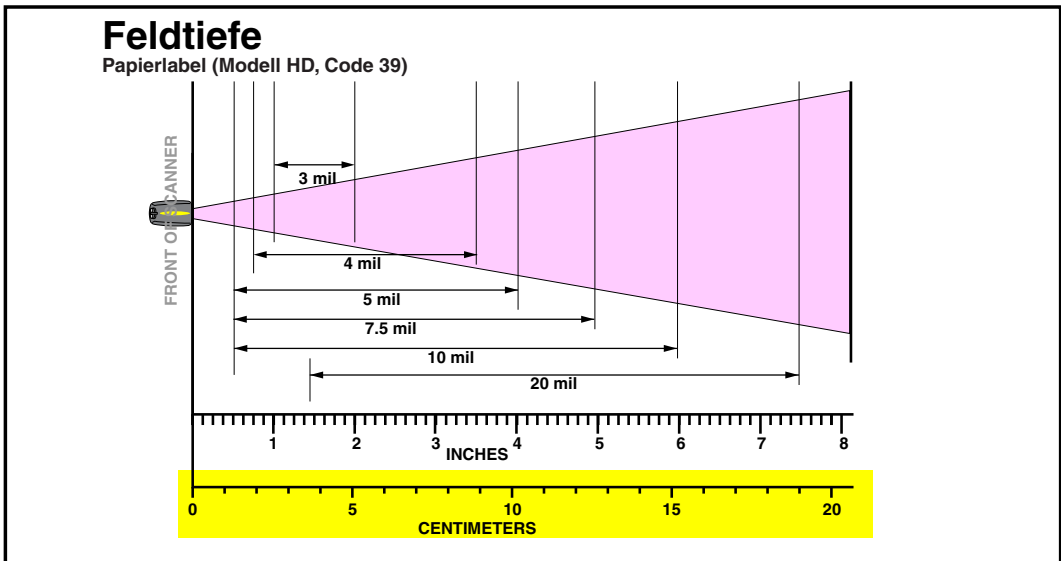



### Hinweis

Für weitere Informationen zu diesen Diagrammen siehe Abschnitt "Definition eines "Mil"". Die Messungen basieren auf den Einstellungen der LR-Modelle mit der standardmäßigen 14° Scanbreite (im Gegensatz zu der alternativen Vollwinkeleinstellung von 28°). Für weitere Informationen über Halbwinkelmerkmale siehe "Programmierhandbuch".

Diese Spezifikationen können Änderungen ohne vorige Mitteilung unterliegen.

Abbildung 9: Felddtiefe (LR)

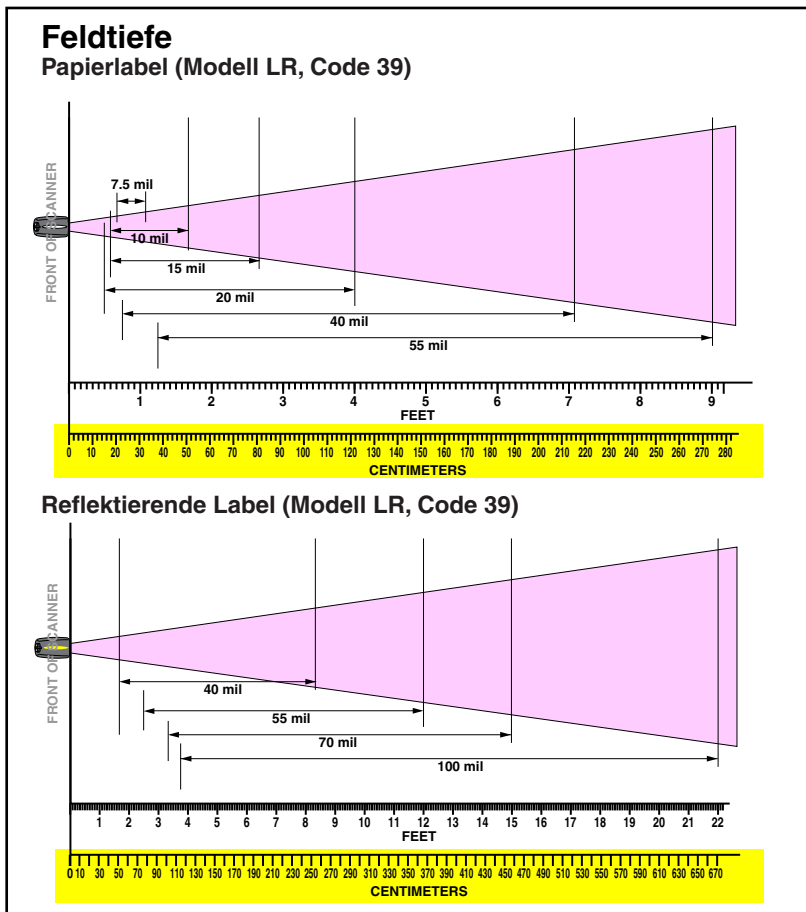



Für weitere Informationen zu diesen Diagrammen siehe Abschnitt "Definition eines "Mil"". Die Messungen basieren auf den Einstellungen der XLR-Modelle mit der 10° Scanwinkelbreite.

**Hinweis**

Diese Spezifikationen können Änderungen ohne vorige Mitteilung unterliegen.

**Abbildung 10: Feldtiefe (XLR)**

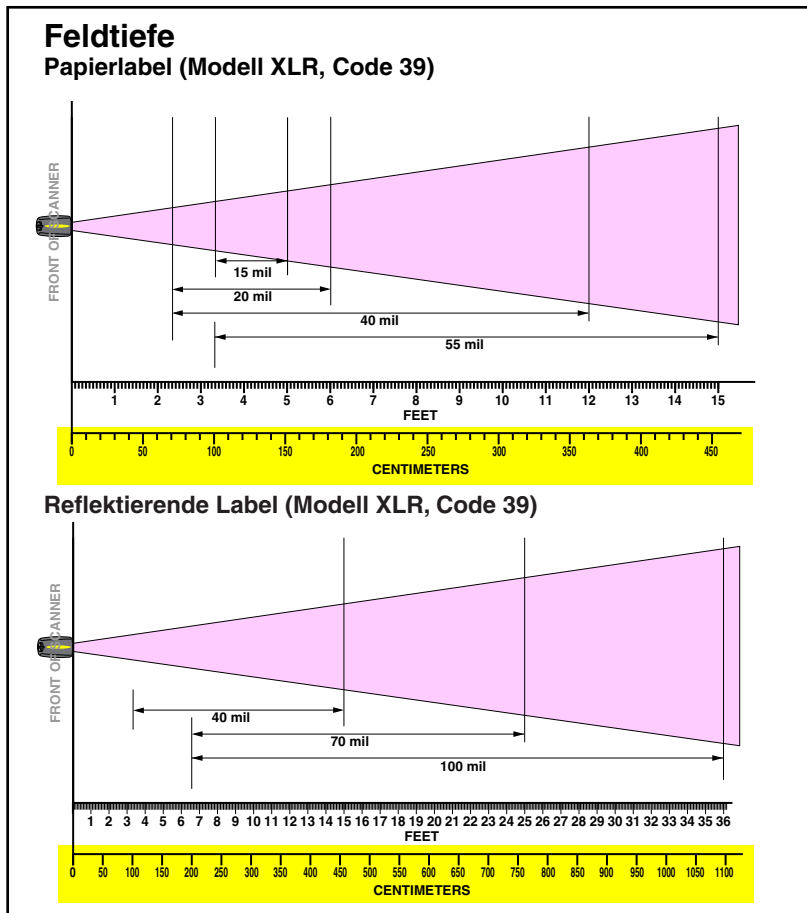

## LED- und Signal-Anzeigen





Die LED-Anzeigen der Basisstation und die LEDs des Scanners sowie die Pieptöne geben den Systemstatus an und führen weitere nützliche Signale durch. Die folgende Tabelle listet die Standardvorgaben für jede der verschiedenen Anzeigen auf.

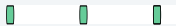

**Hinweis**

**Einige LEDs und Signal-Anzeigen können abgestellt oder über die Scanner-Programmierung geändert werden. In der Tabelle wird die Standardvorgabe der Anzeigen aufgeführt, wobei die farbgestuften Reihen die programmierbaren Merkmale aufzeigen.**



**Tabelle 1: Grüne LED-Funktionen des Scanners**







LED-Anzeige	Dauer	Kommentar
Anzeige Abgeschaltet	100 ms an, 900 ms aus 	Zeigt an, dass der Scanner ausgeschaltet ist.
Anzeige Einlesung gut	500 ms an 	Zeigt an, dass ein Barcode gelesen und dekodiert wurde.
Anzeige Programm-Modus	500 ms an, 500 ms aus fortlaufendes Blinken 	Zeigt an, dass sich der Scanner im Programmier-Modus befindet.
Anzeigen Feld-austauschbare Einheit (FRU)	Unterschiedlich. Besteht aus einem langen Blinken gefolgt von vielen kurzen Blinken. 	Ermöglicht es dem Servicetechniker, Fehler einer Feld-austauschbaren Einheit (FRU) zu identifizieren.
Anzeige geringe Batterieladung	Zweimaliges Blinken bei 100 ms an, 350 ms aus. 	Tritt beim Ziehen des Auslösers auf, bevor der Laser aktiviert wird. Zeigt an, dass die Batterie aufgeladen werden muss.

**Tabelle 2: Gelbe LED-Funktionen des Scanners**

LED-Anzeige	Dauer	Kommentar
Anzeige Laser an	an, stetig 	Die gelbe LED leuchtet immer dann, wenn der Laser eingeschaltet ist.

**Tabelle 3: Signal-Funktionen des Scanners**





Anzeige Lautsprecher	Dauer	Kommentar
Scanner im Moment nicht verbunden	sechs Pieptöne bestehend aus 20 ms an, 20 ms aus 	Zeigt an, dass ein Barcode gelesen wurde, bevor der Scanner mit einer Basisstation verbunden wurde.
Signal Einlesung gut	100 ms an (kurz)   250 ms an (mittel)  500 ms an (lang) 	Es stehen drei programmierbare Funktionen zur Verfügung. Sie zeigen an, dass ein Barcode eingelesen und dekodiert wurde.
kurzer Signal Einlesung teilweise	20 ms an 	Ein sehr kurzer Signal ertönt, wenn ein Barcode eines Zwei-Barcode-Paares erfolgreich dekodiert wurde.

Anzeige Lautsprecher	Dauer	Kommentar
Signal Bestätigung der Basisstation	100 ms an (kurz)  250 ms an (mittel)  500 ms an (lang) 	Zeigt an, dass eine erfolgreiche Barcode-Übertragung zum Hauptterminal (konfigurierbar), ein erfolgreicher Kanalwechsel oder eine erfolgreiche Übertragung einer neuen Konfiguration zum Hauptterminal stattgefunden hat.
Signal Übertragungsfehler	hoch dann niedrig, dann hoch, dann niedrig. 	Zeigt eine erfolglose Übertragung zum Hauptterminal an.
Signal Verbindung	niedrig, dann mittel, dann hoch. 	Zeigt an, dass ein Scanner erfolgreich mit einer Basisstation verbunden wurde.
Signal Verbindung unterbrochen	hoch, dann mittel, dann niedrig 	Zeigt an, dass die Verbindung eines Scanners erfolgreich von einer Basisstation getrennt wurde.
Anzeigen Feld-austauschbare Einheit (FRU)	Verschieden. Besteht aus einem langen Ton gefolgt von vielen kurzen Tönen. 	Ermöglicht es dem Servicetechniker, Fehler einer Feld-austauschbaren Einheit (FRU) zu identifizieren.

**Tabelle 4: LED-Funktionen der Basisstation**

LED-Anzeige	Dauer	Kommentar
Strom	konstantes Leuchten 	Zeigt die bestehende Netzspannung an.



LED-Anzeige	Dauer	Kommentar
TX/RX (Übertragen/ Empfangen)	leuchtet über eine variable Zeitdauer <sup>a</sup> 	Zeigt eine bestehende Kommunikation zur oder von der Basisstation an.
	fortlaufendes schnelles Blinken bei angelegter Netz- spannung 	Zeigt ein beschädigtes Empfangsgerät an.
	Verschieden. Besteht aus einem langen Blinken gefolgt von vielen kurzen Blinken 	Ermöglicht es dem Service- techniker, einen Fehler der Feld-austauschbaren Ein- heit (FRU) zu identifizieren.
Aufladung (Batterie)	fortlaufendes Blinken 	Wenn ein Scanner in eine Basisstation gelegt wurde, zeigt dies an, dass die Bat- terie des Scanners schnell aufgeladen wird.
	konstantes Leuchten 	Wenn ein Scanner in eine Basisstation gelegt wurde, zeigt dies an, dass die Bat- terie des Scanners fast oder vollständig aufgeladen ist.
	kein Leuchten	Es ist kein Scanner vorhanden oder ein Scan- ner ist falsch in die Station eingelegt. Es kann auch bedeuten, dass die Batteri- temperatur unterhalb von 0°C liegt (zu kalt zum Aufladen).

- a. Die LED bleibt an, während die Einheit in dem Moment einen Code bearbeitet, der das Auftreten eines TX/RX verlangt. Die Dauer der LED-Anzeige ist abhängig von der Länge der Nachricht.

## Aktive Symboliken

Die aktiven (aktivierten) Barcodesymboliken der werksseitigen Standardvorgaben sind:

- Code 39 (C39)
- Code 128 (C128)
- Überlappung 2 von 5 (I 2 von 5)

Ihr Scanner sollte mit diesen werksseitigen Einstellungen der Standardvorgaben vorprogrammiert sein, sofern ...

... Ihnen der Scanner nicht mit einer besonderen Kundenkonfigurations-Einstellung geliefert wurde.

... Sie oder ein anderer Anwender keine Änderungen an der Scannerprogrammierung vorgenommen haben.

## Erweitertes Scannen für schlecht lesbare Barcodes

Dekodierte Scanner können so programmiert werden, dass eine extrem schlechte Barcodequalität durch Aktivierung des fortschrittlichen Quadralogic II™ Decoding dekodiert werden kann. Um dieses Merkmal auszuwählen, siehe "Programmierrichtlinien".

Die Scannerprogrammierung kann auch mit Ihrem PC und dem Configurator Express™ on-Screen Programming Kit durchgeführt werden.



### Hinweis

Informationen über Handbücher, Kits und Programmiersoftware für dieses Produkt stehen auf unserer Webseite zur Verfügung. Unsere Webanschrift finden Sie auf der Rückseite des Handbuchs.

## Abbildung 11: Scanner-Etikettierung und Nomenklatur

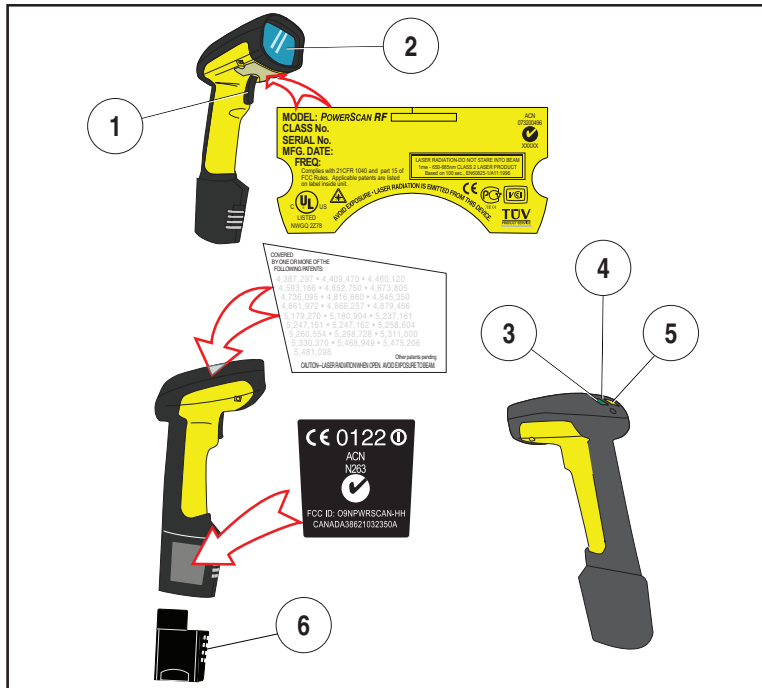

- |                 |               |
|-----------------|---------------|
| 1. Auslöser     | 4. Haltehaken |
| 2. Scan-Fenster | 5. Gelbe LED  |
| 3. Grüne LED    | 6. Batterie   |



### Hinweis

Abbildung 11 oben zeigt NUR die Anordnung der Etiketten. Für Informationen zu derzeitigen Bestimmungen, Patenten und anderen anwendbaren Informationen siehe Etiketten auf dem Produkt selbst oder wenden Sie sich an Ihren nächstgelegenen Verkaufs- oder Servicevertreter.

---

## Warnhinweise für Laseranwendung

Der PowerScan RF Barcodescanner ist in den USA zertifiziert und entspricht den Anforderungen von DHHS/CDRH 21 CFR Unterkapitel J für Laserprodukte der Klasse II (SR und LR) und Klasse IIIa (XLR). Produkte der Klasse II und IIIa sind nicht als gefährlich eingestuft. Der Scanner enthält eine Visible Laser Diode (VLD) mit einer Wellenlänge von 650-670 Nanometer und ist so konstruiert, dass bei normalem Betrieb, normaler Anwenderwartung oder bei den vorgeschriebenen Servicearbeiten kein menschlicher Zugang zu schädigenden Laserlichtebenen möglich ist.



### Achtung

In dem unwahrscheinlichen Fall, dass anstelle einer Scannerlinie ein heller Laserpunkt gesehen wird, blicken Sie nicht in den Strahl und versuchen Sie nicht, die Einheit zu reparieren. Unterbrechen Sie den Betrieb und übergeben Sie die Einheit Ihrem Händler. Beachten Sie, dass bei der Anwendung des Marker-Beam-Modus kurz vor einer Scannerlinie ein einziger zielgerichteter Punkt projiziert wird, der keine Fehlerfunktion darstellt.



### Achtung

Öffnen Sie niemals irgendein Bauteil in der Optikhöhle oder führen Sie Wartungen daran aus. Das Öffnen oder Warten eines Teils der Optikhöhle durch nicht autorisierte Personen kann die Laser-Sicherheitsbestimmungen verletzen. Das Optiksystm wird ausschließlich im Werk repariert.



### Hinweis

Der PowerScan<sup>®</sup> RF Scanner darf nur zusammen mit der Basisstation, Modell: PowerScan RF Base Station verwendet werden.

---

## Hochfrequente Störungen

Dieses Gerät erfüllt Teil 15 der FCC-Bestimmungen. Der Betrieb unterliegt den folgenden zwei Bedingungen:

1. Dieses Gerät verursacht keine schädlichen Störungen.
2. Dieses Gerät akzeptiert alle empfangenen Störungen, einschließlich Störungen, die einen nicht gewünschten Betrieb verursachen.

Dieser digitale Apparat der Klasse A erfüllt Canadian ICES-003.

Cet appareil numérique de la classe A est conforme à la norme NMB-003 du Canada.

Dieses Gerät wurde getestet und erfüllt die Grenzen eines digitalen Gerätes der Klasse B gemäß Teil 15 der FCC-Bestimmungen. Diese Grenzen sind gesetzt, um einen angemessenen Schutz gegen schädliche Störungen bei Installation in einem Gebäude zu gewährleisten. Diese Ausrüstung kann hochfrequente Energie erzeugen, nutzen und ausstrahlen; wenn diese Ausrüstung nicht gemäß dieser Anweisungen installiert und angewendet wird, kann sie schädliche Störungen des Funkverkehrs verursachen. Es gibt jedoch keine Garantie dafür, dass bei einer besonderen Installation keine Störungen auftreten werden. Wenn diese Ausrüstung schädliche Störungen in Bezug auf den Radio- oder Fernsehempfang verursacht, was festzustellen ist, in dem das Gerät an- und ausgeschaltet wird, dann wird dem Anwender empfohlen, die Störung durch eine oder mehrere der folgenden Maßnahmen zu beheben:

- Richten Sie die Empfangsantenne neu aus oder stellen Sie sie an einen anderen Platz.
- Erhöhen Sie den Abstand zwischen der Ausrüstung und den Empfänger.
- Schließen Sie die Ausrüstung an einen Netzstecker an, der nicht zum Stromkreislauf des Empfängers gehört.
- Fragen Sie den Händler oder einen erfahrenen Radio- und Fernsehtechniker um Rat.

---

## Wartung

Das Scanfenster muss gelegentlich gereinigt werden, um Schmutz, Staub und andere Rückstände zu beseitigen. Für eine optimale Leistung reinigen Sie das Scanfenster mit einem weichen Tuch oder einem Linsentuch, das mit Isopropylalkohol (oder Ähnliches) angefeuchtet ist. Siehe Abbildung 12. Der Scannerkörper kann ebenso mit dieser Methode gereinigt werden.

**Abbildung 12: Reinigung des Scanfensters**

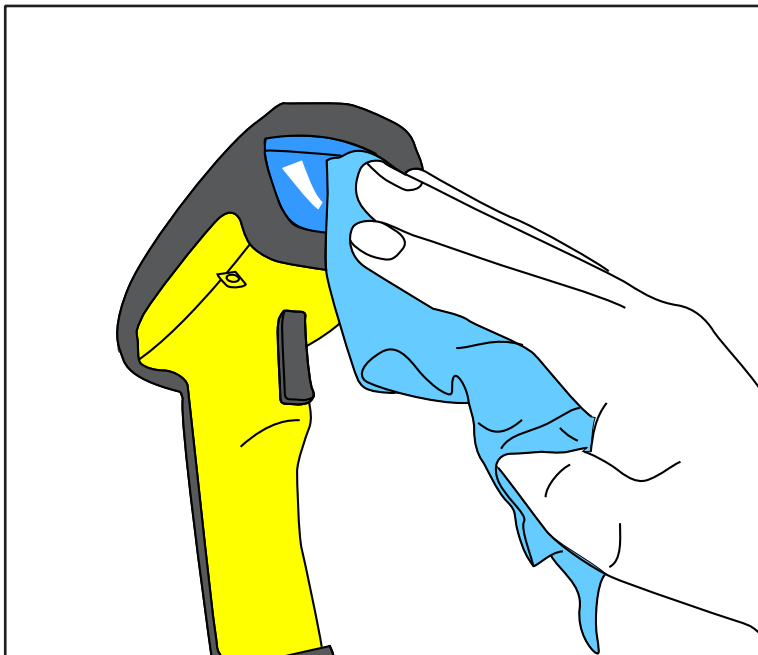

---

## Fehlersuche

Sie führen die Fehlersuche für Ihr RF-Scanningsystem nach den folgenden Checks durch:

Für das RF-System vergewissern Sie sich, dass

- die Batterie geladen ist. Siehe "Batterieaufladung und Wartung" auf Seite 38.
- die Batterie korrekt eingelegt ist. Siehe "Einlegen der Batterie" auf Seite 32.
- der Scanner mit der gewünschten Basisstation verbunden ist. Siehe "Verbinden des Scanners mit der Basisstation" auf Seite 35.
- der Scanner im korrekten Betriebsbereich zur Basisstation steht, ohne dass sich größere Hindernisse zwischen den Funkeinheiten befinden, wie dicke Wände oder schwere Maschinen. (Zum Zeitpunkt des Verfassens dieses Handbuchs wird der maximale Sichtlinienbereich mit 50m spezifiziert).
- keine lokalen Signalstörungen mit anderen funkbetriebenen Ausrüstungen bestehen. Im Systemhandbuch finden Sie Informationen zur Auswahl alternativer Kanäle.
- die Basisstation an das Stromnetz angeschlossen ist. Sie können den AC-Adapter der Basisstation mit einem bekannten und funktionierenden AC-Adapter überprüfen.
- das Schnittstellenkabel der Basisstation sicher am Hauptterminal angeschlossen ist. Für den korrekten Kabelanschluss Ihres Scanners fragen Sie Ihren technischen Supportmanager oder identifizieren Sie den Anschluss mit Hilfe des Handbuchs für das Hauptterminal. Wenn erforderlich, prüfen Sie die Funktion des Schnittstellenkabels, in dem Sie ein bekanntes und funktionierendes Schnittstellenkabel verwenden.

Wenn sich das Problem nur auf das Scannen bezieht, dann prüfen Sie ob ...

- die Barcodes, die Sie scannen wollen, von zufrieden stellender Qualität sind. Barcode-Etikettenprüfer erhalten Sie von Ihrem Händler, wenn Sie ein präzises Einlesen der Etiketteneinheiten benötigen. Beschädigte Barcodes (geknickt, verschmutzt oder gerissen) können dazu führen, dass der Scanner die Codes schlecht oder gar nicht einlesen kann. Wenn es scheint,

---

dass das Problem bei den Barcodes liegt, prüfen Sie, ob der Scanner einen Muster-Barcode von den folgenden Seiten lesen kann.

- die programmierbare Einstellung für fortgeschrittene Quadralogic II™-Dekodierung optimal für Ihr System eingestellt ist. (Siehe "Erweitertes Scannen für schlecht lesbare Barcodes" auf Seite 50.)



---

## Muster-Barcodes

Verwenden Sie diese Test-Barcodes, um die Fähigkeit des Scanners zum Einlesen der verschiedenen Symboliken zu prüfen.

Code 128



Code 39



Überlappend 2 von 5



Standard 2 von 5



Codabar



Code 93



MSI/Plessey



14476925 4

UPC-A



0 00112 23344 0

UPC-A mit 2 Zeichen Add-on



0 60992 01118 7 4 9

UPC-A mit 5 Zeichen Add-on



0 08029 51041 8 6 9 0 0 0

UPC-E



0 998875 0

EAN-8



0021 0126

EAN-13



1 101234 567891

---

---

## FRANÇAIS SOMMAIRE

Déballage et inspection de votre scanner .....	61
References .....	61
Instructions Pour le Demarrage Rapide .....	61
Installation de la Batterie .....	62
Vérification du scanner .....	63
Connexion de la Base au Terminal Hote .....	63
Liaison du Scanner a la Base .....	65
Verification de la Communication Entre la Base et le Scanner .....	66
Utilisation du PowerScan RF .....	67
Chargement et maintenance de la batterie .....	67
Astuces Pour Augmenter la Duree de Vie de la Batterie .....	68
Recyclage de la Batterie .....	68
Chargeur Quatre Emplacements .....	69
Comment Scanner .....	70
Profondeur de Champs .....	71
Indicateurs : LED et Beeper .....	75
Les Symbologies Actives .....	79
Augmenter les Performances de Lecture Pour Code Difficile a Lire .....	79
Securite .....	81
Interference de la Radio Frequence .....	82
Maintenance .....	83
Depannage .....	83
Exemplaires de Codes a Barres .....	85

---

Datalogic Scanning Sarl  
LES ULIS Cedex, France  
Ph: [33].01.64.86.71.00  
Fax: [33].01.64 46.72.44

Datalogic, le logo Datalogic, Quadralogic et Powerscan sont des marques déposées de Datalogic Scanning, Inc. . Toute autre marque ou nom déposé mentionnés ci-après sont les biens de leur propriété respective.

Tous les droits sont réservés. Le contenu, même partiel de cette brochure ou des procédures décrites ci-après ne peuvent faire l'objet de copie et ne doivent en aucun cas circuler sous aucune forme ou par n'importe quel moyen sans avoir, au préalable, obtenu l'autorisation de Datalogic Scanning, Inc. Les détenteurs de produits Datalogic Scanning, Inc. se voient accorder une licence de non-exclusivité révocable leur donnant la possibilité de reproduire et de transmettre cette documentation à des fins internes uniquement. Les acheteurs ne peuvent enlever ou modifier les notifications, y compris celles concernant les droits d'auteur contenus dans ce document ; et doivent s'assurer que toutes les remarques apparaissent sur chaque reproduction du manuel.

Si une quelconque version future devait être publiée, vous pourriez en obtenir un exemplaire en contactant le service clientèle. Des versions électroniques sont téléchargeables à partir du site Web de Datalogic (<http://www.scanning.datalogic.com>) mais vous avez la possibilité de vous les procurer de la manière qui vous convient le mieux. Si vous allez sur notre site Web et désirez apporter des commentaires ou émettre des suggestions concernant une ou plusieurs publications Datalogic, merci de nous le faire savoir en inscrivant vos remarques sur la page " contact Datalogic " de notre site.

### **Réserve**

Des moyens ont été mis en œuvre pour s'assurer que toute information contenue dans ce manuel soit complète et précise.

Néanmoins, Datalogic se réserve le droit de modifier certains éléments à tout moment sans avertissement préalable.

---

## Déballage et inspection de votre scanner

Après avoir ôté de son emballage votre lecteur, bien vérifier le contenu du carton pour s'assurer qu'aucun article commandé ne manque, à savoir :

- Le scanner PowerScan RF ;
- Le(s) pack(s) batteries ;
- Le guide de l'utilisateur (que vous avez en main) ;
- Les accessoires optionnels que vous avez pu commander (le scanner peut être acheté avec ou sans kits accessoires).

Si votre colis contient des articles endommagés ou si des composants sont manquants, n'hésitez pas à contacter votre Service Client habituel. Si certains produits sont défectueux, remplissez sans attendre une fiche de réclamation auprès du transporteur. Vous devrez sûrement garder l'emballage au cas où il faudrait retourner le matériel ultérieurement.

## References

Pour plus d'informations concernant ce produit, et ses documentations, logiciels, et accessoires, visitez notre site Web dont l'adresse se trouve sur la dernière page du présent manuel.

## Instructions Pour le Demarrage Rapide

Ces étapes basiques, ci-dessous, doivent être réalisées pour le paramétrage du scanner RF. Chacune de ces étapes est détaillée dans ce manuel.

- Installation de la Batterie ;
- Vérification du scanner ;
- Connexion de la Base au Terminal Hote ;
- Liaison du Scanner a la Base ;
- Verification de la Communication Entre la Base et le Scanner.

## Installation de la Batterie



### NOTE

Pour assurer un maximum d'utilisations, les batteries doivent toujours être chargées au maximum avant la première utilisation. (Voir "Chargement et maintenance de la batterie" en page 67.)

Orientez la batterie selon la Schéma 1, puis poussez la dans le scanner jusqu'à ce que vous entendiez un clic de mise en place. Pour enlever la batterie, pressez les deux cotés de la base de la batterie et tirer la pour l'extraire du scanner.

### Schéma 1. Installation de la batterie

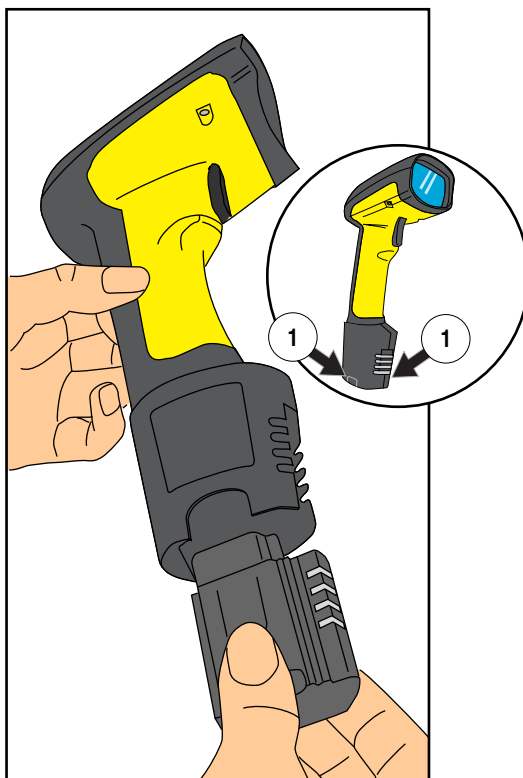

1. Enlèvement de la batterie

## Vérification du scanner

Une fois que la batterie chargée a été installée dans le scanner, scannez les exemplaires de codes à barres à la fin de ce manuel qui correspondent aux symbologies pour lesquelles votre scanner est programmé. Si vous n'êtes pas sûr de savoir comment le faire, voyez la section " Comment Scanner " de ce manuel. Le système devra vous signaler avec un ou plusieurs indicateurs dépendant de la manière dont votre scanner et sa base sont programmés à répondre (Voir " Indicateurs : LED et Beeper " pour plus de détails). Si votre scanner ne réussit pas à lire un exemple de code de la symbologie pour laquelle il est programmé, lire la section " Dépannage ".

## Alimentation

Modèles référencés Classe II et Classe III nécessitant une alimentation externe (Limited Power Source).

Afin de valider le certificat de sécurité, l'alimentation classe III doit être certifiée IEC/EN60950-1 (Séries EN 60335, EN 60065 ou équivalent).

Input: 100 - 240 VAC Output: 9 - 10 VDC

Max. Current: 2.0 A Max. Power: 20 W

Pour les chargeurs 4 positions

Input: 100 - 240 VAC Output: 12 VDC

Max. Current: 2.5 A Max. Power: 30 W

## Connexion de la Base au Terminal Hote



### NOTE

**Il est important que le câble interface (I/F) soit connecté à la base avant d'alimenter le système. En effet, ce type d'interface (RS 232, IBM, Keyboard Wedge, etc...) est choisi par la base en fonction du câble auquel elle est connectée au moment de sa mise sous tension.**

1. Connecter le câble I/F à la base (voir Schéma 2A). Le câble I/F est inséré dans le connecteur et le clip de maintien pivote sur le câble jusqu'à se qu'on entende un clique de mise en place (voir Schéma 2B). Pour déconnecter le câble, pousser sur le clip (loin de la paroi plastique) pour le libérer et lui permettre de remonter, tout en permettant au câble d'être retiré facilement (voir Schéma 2C).

## Schéma 2. Conection et Deconnection du Câble (I/F)

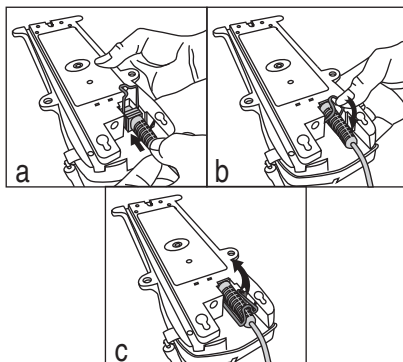

2. Consultez votre manuel de terminal HOTE afin de déterminer les paramètres de communication requis pour le Terminal HOTE (e.g., débit, parité, etc...) et, si nécessaire, modifier les paramètres de programmation afin d'être compatible avec ces exigences. La programmation du scanner et de la base est effectuée en utilisant l'un des moyens suivants :
  - Configurator Express TM », logiciel de programmation
  - PowerScan® Bar Code Scanner Programming Guide.



### NOTE

Voir « References » pour plus d'informations concernant la manière d'obtenir le logiciel ou le manuel de ce produit.



### ATTENTION

Le manuel relatif au terminal HOTE doit être consulté pour savoir si l'alimentation doit être coupée avant la connexion de périphériques. Assurez vous que la procédure est correctement suivie pour éviter des dommages à vos équipements ou altérer les fonctions de votre système.

3. Connectez le câble I / F au port du terminal HOTE (Vérifiez dans le manuel de votre Terminal HOTE afin de déterminer le matériel requis).
4. Connectez le cordon de l'adaptateur AC à la base et branchez l'adaptateur AC/DC dans la prise murale (voir Schéma 3).La



---

LED de la base devrait être allumée quand l'unité est branchée à la prise.

### Schéma 3. Connexion de la Base a L'alimentation

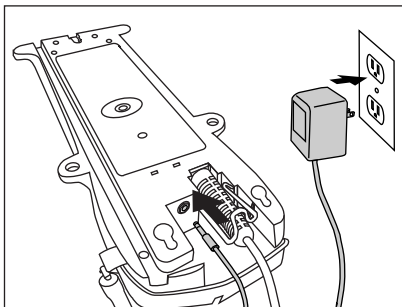

5. Branchez l'alimentation du terminal HOTE.
6. Vérifiez la communication avec le terminal HOTE en pointant un exemplaire de code à barres des dernières pages du présent manuel, et appuyer sur la gâchette. (voir " Comment Scanner " pour des astuces concernant la manière de scanner des codes).Vérifiez que la base du scanner à bien envoyé les données au Terminal HOTE. Sinon, voir la section " Dépannage ". Une fois que toutes les communications sont vérifiées, le système est prêt à l'utilisation.

#### Liaison du Scanner a la Base

Afin de lier le scanner à la base, scanner simplement le code à barres de la base situé au dessus de la base désirée. Alors le scanner cherche la base, un court bip se fait entendre et il détermine le canal correct. Quand la base répond à cette requête, le beeper du scanner émet un son " Lien admis " ou " Lien refusé " (voir la section " Indicateurs : LED et Beeper " pour plus d'informations).

---

La configuration de la base peut être automatiquement chargée sur le scanner. Le téléchargement automatique est configurable et peut être désactivé. Voir " Le Manuel du Système " pour plus d'informations à ce sujet. Si un téléchargement survient, un petit délai avec l'annonce du lien de vérification aura lieu.



**ATTENTION**

Si un scanner de remplacement ou un nouveau scanner est livré avec une configuration client, ou aurait été modifié avec une programmation spécifique, il n'est pas conseillé de télécharger une ancienne configuration provenant d'une base existante.

Dans ce cas, référez-vous au manuel de votre système, ou au logiciel de programmation " Configurator Express TM On-Screen " et télécharger la nouvelle configuration du scanner à la base avant de les relier.

## Verification de la Communication Entre la Base et le Scanner

Pointez le scanner vers un exemplaire de code à barres provenant des dernières pages de ce manuel, et appuyez sur la gâchette (voir " Comment Scanner ", les astuces pour scanner un code). Regarder le TX / RX (transmission / réception) de l'indicateur LED sur la base et / ou la LED verte du scanner pendant que vous scannez le code. La LED devrait clignoter momentanément pendant que les deux appareils communiquent. S'il n'y a pas de communication indiquée, se référer à la section " Dépannage " du Manuel.

Quand le scanner est programmé pour le faire, la communication peut aussi être indiquée par un second signal<sup>1</sup> " d'acquiescement " qui peut être entendu après un signal de bonne lecture. Si un bip d'erreur de transmission est entendu après un signal de " bonne lecture " au lieu du signal d'acquiescement, la communication entre les deux appareils a échoué<sup>2</sup>. Référez-vous à la section " Utilisation du PowerScan RF ", et " Depannage " pour les différentes solutions possibles, en cas de besoin.

- 
1. Voir " Indicateurs : LED et Beeper " pour plus de détails concernant les signaux de bip.
  2. Une autre raison provoquant des " signaux d'erreur " est que la base peut être configurée différemment du scanner, ou que le système d'interface ne supporte pas la symbolologie (type de code à barres) que vous essayez de lire.

## Utilisation du PowerScan RF

Cette section couvre les sujets suivants :

- Chargement et maintenance de la batterie ;
- Comment Scanner ;
- Indicateurs : LED et Beeper.

### Chargement et maintenance de la batterie



#### NOTE

Lorsque le scanner est en marche, un état de batterie faible est indiqué par deux flashes répétés de la LED verte du scanner à chaque fois que la gâchette est actionnée avant d'utiliser le laser. Cet indicateur peut avoir été mis hors d'usage via la programmation client. Voir " Indicateurs : LED et Beeper " pour plus d'informations .

Poser le scanner sur sa base comme montré en Schéma 4, assurez-vous que la batterie est complètement enclenché et en contact avec les embouts métalliques de la base. La LED de charge de la base doit cli-gnoter, indiquant que la batterie est en charge.

#### Schéma 4. Chargement de la batterie

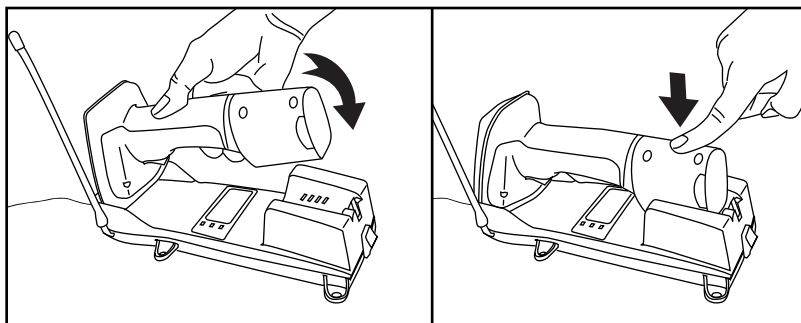

---

Des clignotements rapides indiquent que le chargement est en cours. Un chargement rapide se réalise lorsque la température de la batterie est entre 10°C et 46°C, et/ou la tension de la batterie est entre 2.0 et 3.2 V. Le temps de charge est inférieure à 4.2 heures. La fin de la charge rapide se fait approximativement à 90 et 95 % de la capacité. La LED de charge reste stable lors de la charge lente ou lorsque le cycle de charge est achevé.



**NOTE**

**Un scanner peut être chargé simultanément pendant que d'autres scanners sont utilisés avec la base.**



**NOTE**

**Les batteries ne se chargeront pas si leur température est en dessous de 0°C. Si une batterie qui est trop froide est insérée dans la base, la LED de chargement ne s'allumera pas.**

### **Astuces Pour Augmenter la Duree de Vie de la Batterie**

Les batteries Nimh (Nickel Metal Hydride) conserveront leur charge plus longtemps si vous leur permettez de se décharger complètement au moins une fois par semaine. La réaction chimique qui correspond à un chargement ou à un déchargement de batterie doit avoir lieu pour maximiser le nombre de cycles de chargements / déchargements de la batterie. Si une batterie est enlevée du scanner et entreposée, elle doit être complètement chargée pour être stockée. Les batteries perdront leur capacité à garder leur charge quand elles sont stockées pendant de longues périodes (semaines, mois, ou plus long).

Les batteries auront généralement 30 % de leur capacité à la livraison. Pour assurer un maximum d'utilisations, la batterie doit être complètement chargée avant l'utilisation.

Stockez votre batterie dans un endroit sec et frais. Ne laissez pas votre batterie en contact direct avec les rayons du soleil ou une température inférieure à 0°C et supérieure à 38°C.

### **Recyclage de la Batterie**

Il n'y a pas à ce jour aux US, en Amérique du Nord ou dans le reste du monde de dispositions concernant les batteries Nimh. Donc, lorsque les batteries ne tiennent plus la charge, vous pouvez vous en séparer, de préférence dans un endroit de recyclage agréé.

## Chargeur Quatre Emplacements

Si vous disposez d'un chargeur 4 emplacements, les batteries sont insérées pour le chargement (voir en Schéma 5). Une charge rapide (90 %) peut être terminée au bout de 2 heures seulement en utilisant cet accessoire optionnel, la moitié du temps requis par une base. La LED de chaque emplacement batterie, opère comme la LED de chargement de la base, avec une lumière clignotante indiquant que la charge rapide est en place et stable durant la charge lente finale ou lorsque le cycle de charge rapide est terminé.



### NOTE

Si vous insérez une batterie dans le chargeur quatre emplacements et qu'aucune LED ne s'allume, la batterie doit être trop froide. Les batteries doivent être à 0°C ou plus pour être chargées. N'essayez pas de charger de batteries froides, si vous les placez dans le chargeur elle diminuerait la charge des autres batteries déjà présentes.

### Schéma 5. Utilisation du Chargeur 4 Emplacements

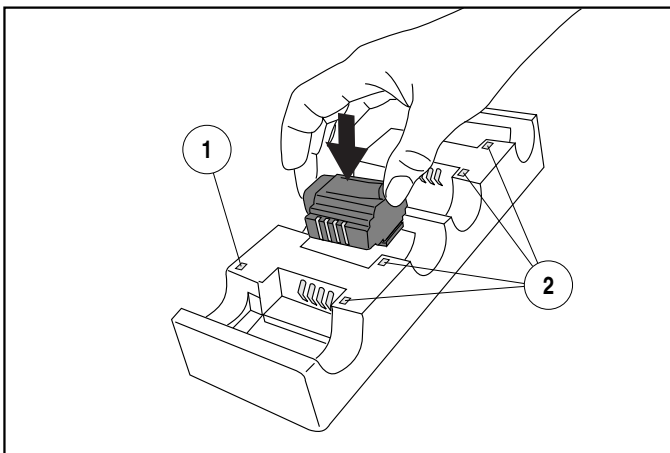

1. LED d'alimentation

2. LEDS de charge de la base

## Comment Scanner

Le Schéma 6 illustre les différentes astuces pour vous aider à avoir de meilleurs résultats de scan :

1. Appliquer un angle entre le scanner et le code. Ne pas tenir le scanner perpendiculairement au code à barres.
2. Le faisceau du scanner doit entièrement traverser le code à barres. Le scanner ne peut pas lire correctement si le code à barre n'est pas entièrement scanné.

**Schéma 6. Les Astuces Pour Scanner**

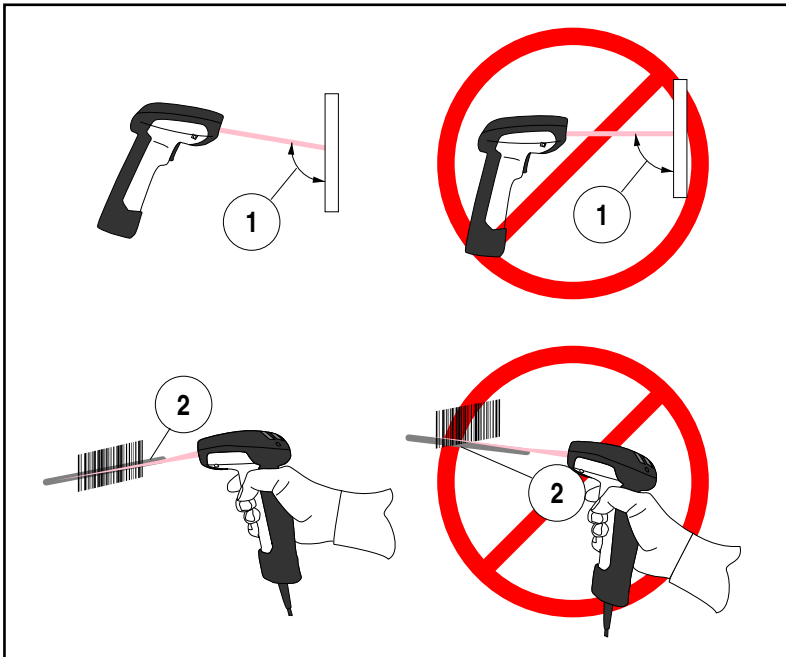

## Profondeur de Champs

Il y a quatre différentes profondeurs de champs pour ce scanner. En fonction du type de modèle de votre scanner, vous aurez besoin de placer le pistolet à une distance déterminée du code à barres pour obtenir des résultats optimum en terme de " scanning ". Les diagrammes suivants fournissent les informations relatives aux profondeurs de champs pour chacun des modèles quand vous scannez un code à barres : Grade A, Code 39 : portée standard (SR), Haute densité (HD), Longue portée (LR) et Extra Long Range (XLR).

## Définition d'un Mil

Un " mil " équivaut à 0.00254 cm. Dans le contexte des illustrations de cette section, un mil représente la taille de l'élément (barre ou espace le plus petit). Ainsi, un code à barres de 5 mils devra avoir son élément le plus petit d'une largeur de 5 mils (soit environ 0.0127 cm).

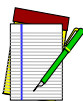

### NOTE

Les mesures sont basées sur les modèles standards SR avec l'angle de lecture de 28° de largeur (contrairement au demi-angle de 14°). Se référer au manuel de programmation pour plus de détail concernant les caractéristique du demi-angle.

Ces spécifications peuvent changer sans avertissement.

## Schéma 7. Profondeur de Champ (SR)

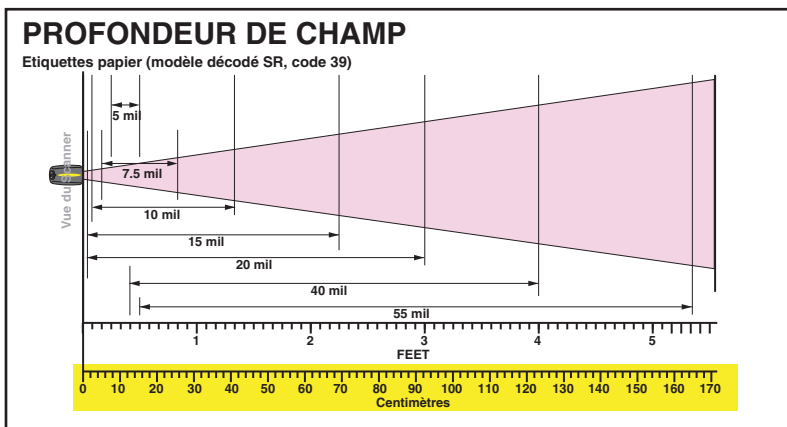



Voir la section intitulée " Définition d'un Mil " pour plus d'information sur la lecture de ce diagramme. Les mesures sont basées sur des modèles HD avec un angle de lecture de  $28^\circ$  (contrairement au demi angle de  $14^\circ$ ). Se référer au manuel de programmation pour plus de détails concernant les caractéristiques du demi angle.

**NOTE**

Ces spécifications peuvent changer sans avertissement.

**Schéma 8. Profondeur de champ (HD)**

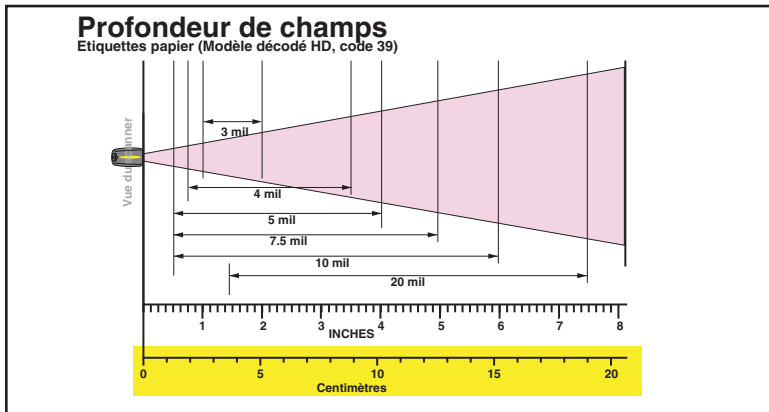



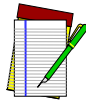

Voir la section intitulée " Définition d'un Mil " pour plus d'informations concernant la lecture de ce diagramme. Les mesures sont basées sur des modèles LR avec un angle de lecture de 14° (contrairement à l'angle de lecture de 28°). Se référer au manuel de programmation pour plus d'information concernant le demi angle.

**NOTE**

Ces spécifications peuvent être changées sans avertissement.

**Schéma 9. Profondeurs de Champs (LR)**

**PROFONDEURS DE CHAMPS**

Etiquettes papier (Modèle décodé LR, code 39)

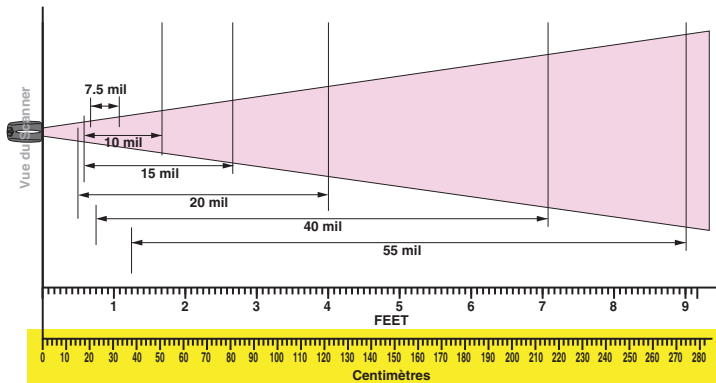

Etiquettes Réfléctives (Modèle décodé LR, Code 39)

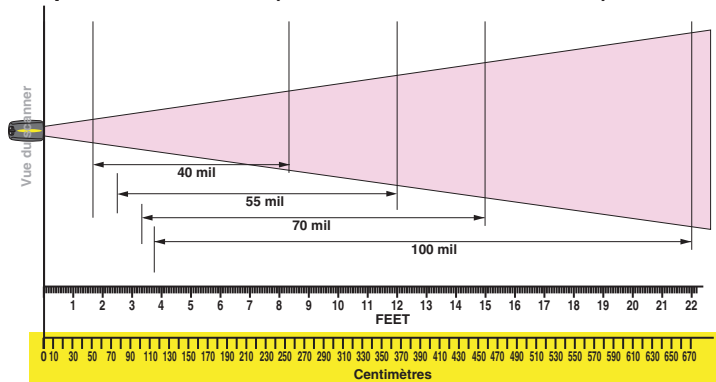

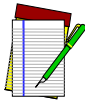

Voir la section intitulée " Définition d'un Mil " pour plus d'informations concernant la lecture de ce diagramme. Les mesures sont basées sur des modèles XLR avec un angle de scan de 10°.

**NOTE**

Ces spécifications peuvent être changées sans avertissement.

### Schéma 10. Profondeur de Champ (XLR)

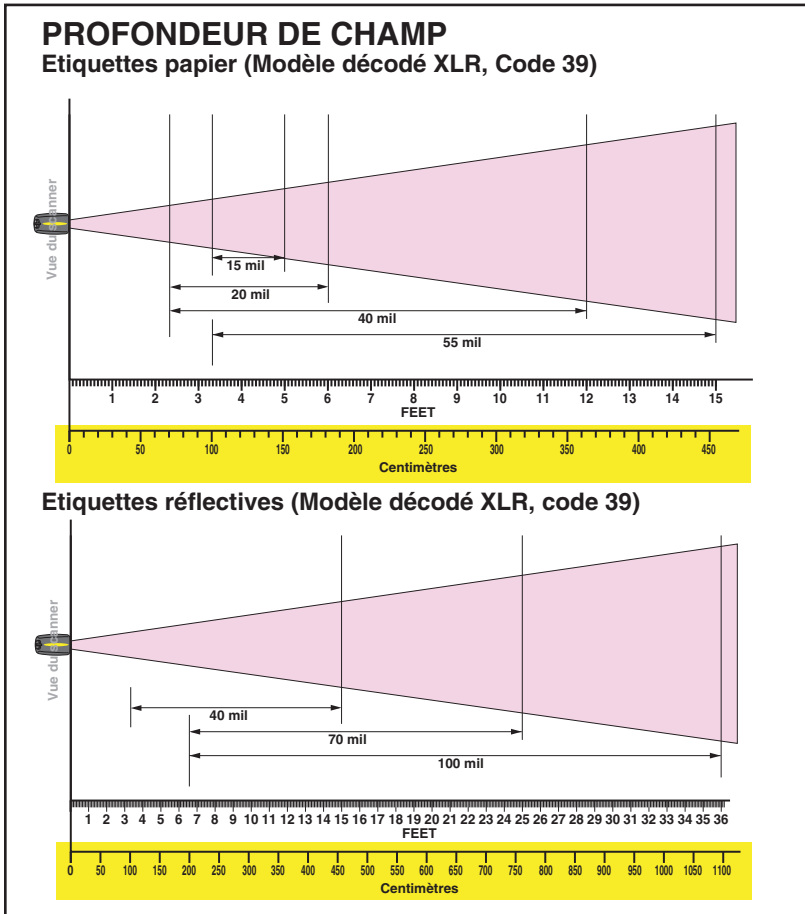

## Indicateurs : LED et Beeper

La LED de la base, la LED du scanner et le Beeper sont utilisés pour annoncer l'état du système et représenter les autres signaux usuels.

Les tableaux ci dessous répertorient les fonctions des divers indicateurs.



### NOTE

Certain indicateurs beeper ou LED peuvent être supprimés ou modifiés par la programmation du scanner. Les tableaux indiquent le comportement par défaut des indicateurs, chaque cellule ombrée représente des caractéristiques programmables.

Table 1. Les fonctions de la LED verte du scanner





INDICATEUR LED	DUREE	COMMENTAIRES
Indication de désactivation	100 Ms allumé, 900 Ms éteint 	Indique que le scanner a été désactivé
Indication de bonne lecture	500 ms allumé 	Indique qu'un code a été lu et décodé
Indication du mode programmation	500 ms allumé, 500 ms éteint flashes continus 	Indique que le scanner est en mode de programmation
Indication d'éléments à remplacer (FRU)	Variable. Longs flashes suivit de multiples courts flashes. 	Permet aux services techniques d'identifier les éléments en erreurs (FRU)
Indicateur de batterie faible	2 Flashes à 100 ms allumés et 350 ms éteint 	A lieu lorsque on appui sur la gâchette avant que le laser soit allumé. Indique que la batterie a besoin d'être rechargée.

**Table 2. Les fonctions de la LED jaune du scanner**



INDICATEUR LED	DUREE	COMMENTAIRES
Indication laser allumé	Stable 	Le LED jaune est allumée lorsque le laser est allumé.



**Table 3. Les fonctions BEEPER du scanner**

INDICATIONS HAUT PARLEUR	DUREE	COMMENTAIRES
Le scanner n'est pas " relié "	Six Beeps, 20 ms on, 20 ms off 	Indique que le code a été lu avant que le scanner soit connecté à la base
Beep de bonne lecture	100 ms (courts)   250 ms (moyens) ▬ 500 ms (longs) ▬▬	Ces 3 fonctions programmables sont disponibles. Elles indiquent que le code a bien été lu et décodé.
Bip de lecture partielle	20 ms 	Un très court beep est entendu lorsque l'un des deux codes a été décodé.
Beep d'acquiescement de la base	100 ms (courts))   250 ms (moyens) ▬ 500 ms (longs) ▬▬	Indique le succès de la transmission du code (configurable), une réussite de changement de canal, ou un transmission réussie d'une nouvelle configuration au HOTE.

INDICATIONS HAUT PARLEUR	DUREE	COMMENTAIRES
Beep d'erreur de transmission	Fort, puis bas, puis fort, puis bas.. 	Indique l'échec de transmission à l'HOTE
Beep de connexion	Faible, puis moyen, et fort 	Indique que le scanner a été lié à la base avec succès
Beep de déconnexion	Fort, puis moyen, et faible. 	Indique que le scanner a bien été déconnecté de la base
Indication d'éléments à remplacer (FRU)	Variable. Consiste en une longue tonalité suivi de multiples petites 	Permet au service technique d'identifier les erreurs (Élément en FRU)

**Table 4. Fonction LED de la Base**

INDICATEUR LED	DUREE	COMMENTAIRES
TX / RX (Emission / Réception)	Illuminée pour une période variable <sup>a</sup> 	Indique la communication venant ou allant à la base
	Rapides flash continus à la mise sous tension 	Indique une radio défectueuse
	Variable. Long flashs suivis de multiples flashs courts. 	Permet au service technique d'identifier les éléments en erreur (FRU)

INDICATEUR LED	DUREE	COMMENTAIRES
Charge (Batterie)	Flash continus 	Lorsqu'un scanner est emboîté dans la base, il indique que la batterie est en charge rapide
	Illuminée et constamment 	Lorsqu'un scanner est emboîté dans la base, il indique que sa batterie est quasiment chargée.
	Non illuminée	Un scanner n'est pas présent ou incorrectement inséré dans la base. Cela peut vouloir dire que la température de la batterie est inférieure à 0°C (trop froide pour être chargée).
Alimentation	Illuminé et constamment 	Indique l'alimentation OK

- a. La Led reste allumée lorsque le scanner est en cours de lecture du code et ce, jusqu'à ce qu'un TX/RX intervienne. La durée de l'allumage de la LED est dépendante de la longueur du message.

---

---

**Les  
Symbologies  
Actives**

Les symbologies actives des codes ( disponibles) dans la configuration standard sont :

- Code 39 (C39)
- Code 128 (C128)
- 2 parmi 5 entrelacé (I2of5)

Votre scanner devrait être pré programmé avec ces paramètres standards, à moins que ...

... il vous a été envoyé programmé avec une configuration spécifique.

... Vous ou un autre utilisateur ait effectué des changements, dans la programmation du scanner.

**Augmenter les  
Performances  
de Lecture  
Pour Code  
Difficile a Lire**

Les scanners décodés peuvent être programmés pour décoder des codes de très faible qualité par l'activation du système avancé de décodage " Quadralogic TM . Pour sélectionner cette caractéristique, voir Le Guide de Programmation.

La programmation du scanner peut être effectuée en utilisant votre PC et le Kit de programmation " The Configuration Express™ On-Screen " .



**NOTE**

**Les informations concernant les manuels, les kits et logiciels de programmation de ce produit sont disponibles sur notre site Web. Voir la dernière page de ce guide pour notre adresse internet.**

## Schéma 11. Etiquetage et Nomenclature du Scanner

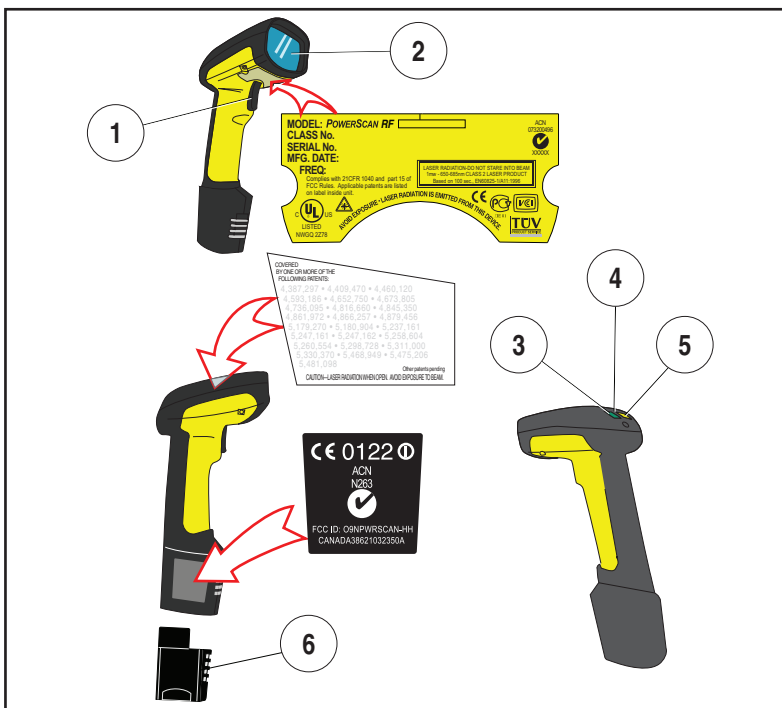

- |              |                          |
|--------------|--------------------------|
| 1. Gâchette  | 4. Crochet de suspension |
| 2. Fenêtre   | 5. LED jaune             |
| 3. LED verte | 6. Batterie              |



### NOTE

Le Schéma 11, ci-dessus, est montré SEULEMENT l'emplacement des étiquettes. Pour des raisons de contrôle, des licences et autres informations en vigueur, regardez les étiquettes sur le produit lui-même, ou contactez votre service commercial ou après-vente habituel.



Le scanner PowerScan RF est certifié conforme aux conditions requises par la norme DHHS/CDRH 21CFR sous chapitre J pour les scanner de classe II. Les produits de classe II ne sont pas considérés comme dangereux. Le lecteur possède une diode laser d'une longueur d'onde de 650-670 nanomètres. Il a été conçu pour que l'accès à des niveaux dangereux de lumière laser ne soit pas possible pendant l'utilisation normale, l'entretien par l'utilisateur ou les fonctions de dépannage recommandées.



### ATTENTION

Si l'appareil émet un point unique rouge lorsque vous appuyez sur la gâchette, plutôt qu'un ligne, ne regardez pas le faisceau ou n'essayez pas de réparer le scanner, arrêtez immédiatement et retournez l'appareil à Datalogic. Excepté lorsque vous utilisez le mode " Marker Beam " un seul point est projeté momentanément.



### ATTENTION

Ne pas essayer d'ouvrir ni de réparer un quelconque composant de la cavité optique. L'ouverture ou la réparation des composants de la cavité optique par un personnel non qualifié peut entraîner la violation des réglementations relatives à la sécurité laser. L'optique de système ne peut être réparé qu'en usine.

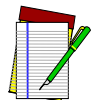

### NOTE

Le scanner PowerScan RF ne peut être utilisé qu'avec la Base Datalogic, Model : " PowerScan RF Base Station ".

---

---

## Interference de la Radio Frequence

Cet appareil est conforme au paragraphe 15 du règlement FCC. Les opérations sont soumises aux deux conditions suivantes :

1. Cet appareil ne doit pas causer d'interférences nuisibles, et
2. Il doit accepter n'importe quelle interférence reçue, y compris les interférences pouvant provoquer un dysfonctionnement.

Cet appareil numérique de classe 13 est conforme aux normes Canadiennes de réglementation des équipements provoquant des interférences.

Cet équipement a été testé et déclaré conforme aux limites des appareils de Classe B, conformément au paragraphe 15 du règlement FCC.

Ces normes permettent d'assurer une protection raisonnable contre les interférences nuisibles lorsque l'appareil est utilisé dans un environnement commercial. Cet équipement génère, utilise et peut émettre de l'énergie haute fréquence et, s'il n'est pas installé et utilisé d'après ces instructions, il peut causer des interférences nuisibles aux communications radio. Cependant, il n'y a aucune garantie que des interférences ne se produiront pas dans une installation résidentielle. Si cet équipement cause des interférences nuisibles à la réception radio ou télévision, qui peuvent être déterminées par éteindre / rallumer l'équipement, l'utilisateur est encouragé à essayer de corriger ces interférences par une ou plusieurs des mesures suivantes :

- Réorientez ou bougez l'antenne de réception.
- Augmentez la distance de séparation entre l'équipement et le récepteur.
- Connectez l'équipement à une source d'alimentation différente de celle à laquelle est connecté le récepteur.
- Consultez un revendeur ou un technicien spécialisé en TV/ Radio pour toute aide.

---

## Maintenance

La fenêtre de scan nécessite un nettoyage régulier pour enlever les salissures, la poussière et autre débris. Afin d'assurer une performance optimale, nettoyez le vitre du scanner en utilisant un tissu doux imprégné d'alcool isopropyl (ou un équivalent). Voir la Schéma 12. Le corps du scanner peut aussi être nettoyé en utilisant cette méthode.

### Schéma 12. Nettoyage de la Fenetre du Scanner

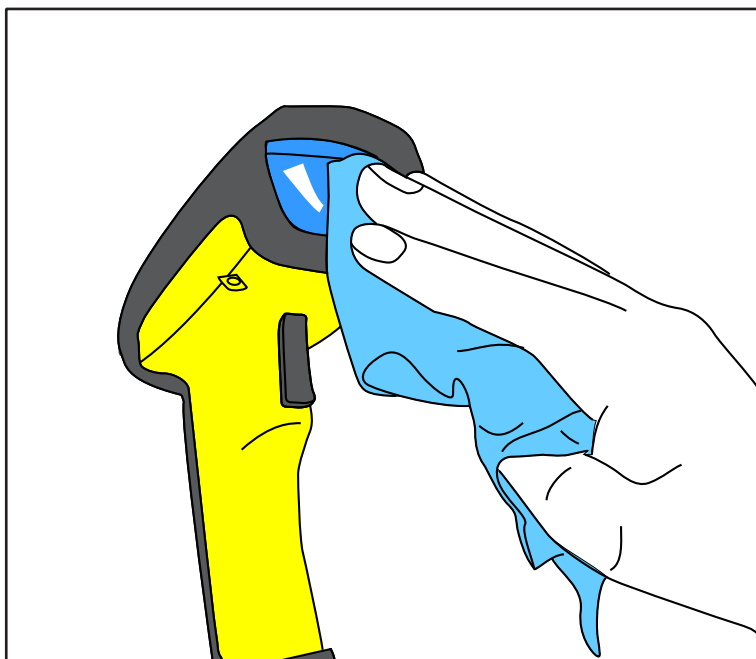

## Depannage

Dépannez votre scanner RF en suivant les étapes suivantes :

Pour le système RF, assurez vous que :

- Le batterie est chargée. Voir "Chargement et maintenance de la batterie" en page 67.
- Le batterie est bien installée. Voir "Installation de la Batterie" en page 62.
- Le scanner est lié à la base désignée. Voir "Liaison du Scanner a la Base" en page 65.

- 
- Le scanner est à une distance raisonnable de sa base, sans obstruction majeure entre l'unité radio tel qu'un mur épais ou une machine lourde. (Au moment de l'écriture de ce manuel, la portée maximum en champs libre est de 45 mètres).
  - Il n'y a pas de signal d'interférence local avec un autre équipement en radio fréquence. Consultez le Manuel du système concernant la sélection des canaux alternatifs.
  - La base est bien alimentée. Vous pouvez vérifier l'adaptateur AC de la base en utilisant un adaptateur AC présentant un fonctionnement correcte.
  - La câble interface de la base est connecté à l'HOTE. Consultez votre Directeur Technique ou référez vous au manuel de votre système HOST pour identifier le câble correct de connexion à votre scanner. Si nécessaire, vérifiez le câble interface en utilisant un câble présentant un fonctionnement correcte.

Si le problème est lié à la lecture, vérifiez que ...

- Les codes à barres que vous êtes en train d'essayer de lire sont d'une qualité satisfaisante. Les vérificateurs de codes à barres sont disponibles chez votre revendeur si vous avez besoin d'un compte rendu détaillé concernant votre étiquette. Les codes à barres qui sont endommagés ( froissés, salis, ou déchirés) peuvent être la cause d'une mauvaise lecture ou d'une non lecture. Si la qualité du code à barres paraît être un problème, essayez de voir si le scanner lit un des exemples de code des pages suivantes.
- Le système de décodage avancé Quadralogic TM est optimalement paramétré sur votre système. (Voir "Augmenter les Performances de Lecture Pour Code Difficile a Lire" en page 79.)

---

## Exemplaires de Codes a Barres

Utilisez ces codes à barres de test afin de définir la capacité de lecture concernant les différentes symbologies représentées.

Code 128



Code 39



2 parmi 5 entrelacé



2 parmi 5 standard



Codabar



Code 93



MSI/Plessey

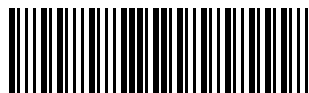

14476925 4

UPC-A



0 00112 23344 0

UPC-A avec 2 caractères Add-on



0 60992 01118 7 4 9

UPC-A avec 5 caractères Add-on



0 08029 51041 8 6 9 0 0 0

UPC-E



0 998875 0

EAN-8



0021 0126

EAN-13



1 101234 567891

---

## ITALIANO INDICE

Disimballo e ispezione del lettore .....	89
Riferimenti .....	89
Istruzioni per l'utilizzo rapido .....	89
Installazione della batteria .....	90
Verifica funzionale del lettore .....	91
Power Supply .....	91
Collegamento del modulo base al terminale host .....	91
Collegamento del lettore al modulo base .....	93
Verifica del collegamento lettore/modulo base .....	94
Utilizzo di PowerScan RF .....	95
Caricamento e manutenzione della batteria .....	95
Smaltimento delle batterie .....	96
Caricabatterie a 4 vani .....	97
Come effettuare la lettura .....	98
Profondità di campo .....	99
Segnalazioni acustiche e luminose (LED) .....	103
Simbologie abilitate .....	106
Scansione avanzata per codici a barre di difficile lettura .....	107
Avvertenze sul laser .....	108
Disturbi in radiofrequenza .....	109
Manutenzione .....	110
Risoluzione dei problemi .....	111
Codici a barre campione .....	112

---

## **Datalogic Scanning, Inc.**

959, Terry Street  
Eugene, Oregon 87402  
Telefono (541) 683-5700  
Telefax (541) 345-7140

Datalogic, il logo Datalogic, Quadralogic II e PowerScan sono marchi registrati di Datalogic Scanning, Inc. Tutti gli altri marchi di fabbrica e nomi commerciali cui si farà qui riferimento appartengono ai rispettivi proprietari.

Tutti i diritti riservati. La documentazione o le procedure qui descritte non possono essere parzialmente riprodotte o trasmesse in qualsiasi forma o modo, senza previo consenso scritto di Datalogic Scanning, Inc. Ai proprietari di prodotti Datalogic Scanning, Inc. viene con la presente garantita licenza revocabile non esclusiva a riprodurre e trasmettere questa documentazione per fini interni. L'acquirente non dovrà rimuovere né alterare alcun avviso di proprietà, comprese le indicazioni di diritto d'autore, contenute in questa documentazione e dovrà assicurarsi che tutti gli avvisi appaiano su tutte le riproduzioni di questa documentazione.

In caso di futuri aggiornamenti di questo manuale, sarà possibile acquistare la versione stampata contattando il Servizio Clienti Datalogic. La versione elettronica potrà essere scaricata dal sito web Datalogic ([www.scanning.datalogic.com](http://www.scanning.datalogic.com)) o distribuita su supporto appropriato. Se visitate il nostro sito e volete esprimere un commento o fornire suggerimenti su questa o altre pubblicazioni Datalogic, fatecelo sapere attraverso la pagina "Contact Datalogic".

### **RINUNCIA**

Per garantire che le informazioni incluse in questo manuale risultino complete e precise sono state adottate misure ragionevoli. Tuttavia, Datalogic si riserva il diritto di cambiare qualsiasi specifica in qualsiasi momento senza preavviso.



---

## Disimballo e ispezione del lettore

Dopo aver disimballato il vostro nuovo lettore, controllate il contenuto dell'imballo per assicurarvi che siano presenti tutti i componenti ordinati:

- Lettore manuale PowerScan RF
- Pacco/i batteria
- Guida dell'operatore (questo manuale)
- Eventuali accessori opzionali (il lettore può essere acquistato con o senza kit accessori)

Se l'imballo contiene componenti sbagliati o mancano componenti, contattate il vostro rivenditore. In caso di componenti danneggiati, sporgete immediatamente reclamo presso il corriere. Conservare l'imballo del lettore per un'eventuale spedizione.

## Riferimenti

Per ulteriori informazioni su questo prodotto, le pubblicazioni pertinenti, il software e gli accessori, visitate il nostro sito web indicato sulla retrocopertina di questo manuale.

## Istruzioni per l'utilizzo rapido

Per configurare il lettore RF eseguire le operazioni indicate di seguito. Ognuna di esse è descritta dettagliatamente in questo manuale.

- Installazione della batteria
- Verifica funzionale del lettore
- Collegamento del modulo base al terminale host
- Collegamento del lettore al modulo base
- Verifica del collegamento lettore/modulo base

## Installazione della batteria



**NOTA**

Per garantire la massima autonomia, le batterie devono sempre risultare completamente cariche prima dell'utilizzo iniziale (Vedere "Caricamento e manutenzione della batteria" a pag. 95).

Orientare la batteria come indicato in Figura 1, quindi spingerla dentro il lettore fino allo scatto in posizione. Per togliere la batteria, premere sulle alette ai lati della base della batteria ed estrarla dal lettore.

**Figura 1. Installazione della batteria**

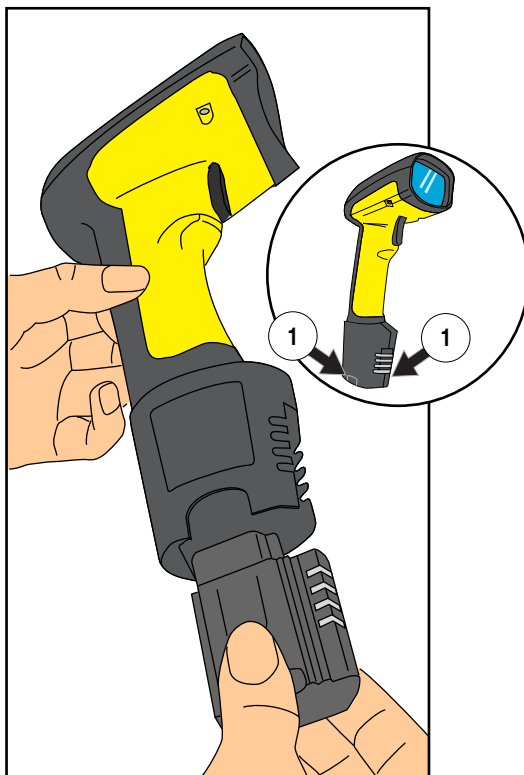

1. Alette di rilascio batteria

## Verifica funzionale del lettore

Dopo aver inserito una batteria carica nel lettore, effettuare la lettura dei codici a barre riportati sul retro del manuale, corrispondenti alle simbologie per le quali è programmato il lettore. Se non sapete come fare, consultate la sezione "Come effettuare la lettura". Il sistema può rispondere con una o più segnalazioni acustiche e luminose, in base a come sono stati programmati il lettore e la stazione base (vedere Segnalazioni acustiche e luminose (LED) per ulteriori informazioni). Se il lettore non legge i codici a barre campione per i quali è stato programmato, vedere la sezione Risoluzione dei problemi.

## Alimentazione

Questi modelli devono essere alimentati con alimentatori omologati di classe II o classe III LPS (Limited Power Source, sorgente di corrente limitata).

Affinché il certificato di sicurezza sia valido, le sorgenti di alimentazione di classe III devono essere conformi a IEC/EN60950-1 (serie EN 60335, EN60065 o relativi).

Tensione ingresso: 100 - 240 VAC

Tensione uscita: 9 - 10 VDC

Consumo massimo: 2.0 A

Potenza massima: 20 W

Per il caricabatterie a 4 slot

Tensione ingresso: 100 - 240 VAC

Tensione uscita: 12 VDC

Consumo massimo: 2.5 A

Potenza massima: 30 W

## Collegamento del modulo base al terminale host



**NOTA**

**il cavo di interfaccia (I/F) deve essere collegato al modulo base prima di attivare il sistema poiché esso determina il tipo di interfaccia (RS-232, IBM, tastiera, ecc.) impostato dal modulo base al momento dell'accensione.**

1. Collegare il cavo I/F al modulo base (Figura 2A). Inserire il cavo I/F nel connettore e quindi fissarlo ruotando il fermo a molla sopra il cavo fino all'aggancio in posizione (Figura 2B). Per scollegare il cavo, premere il fermo per rilasciarlo (sulla parte opposta al gancio della parete in plastica), e rialzarlo per liberare il cavo (Figura 2C):

**Figura 2. Collegamento/scollegamento del cavo di interfaccia (I/F)**

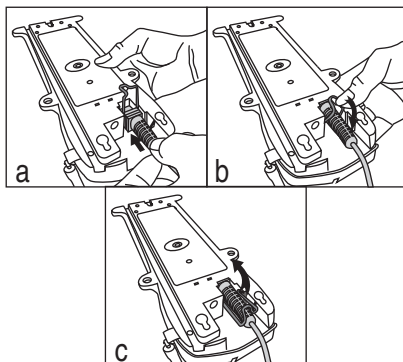

2. Consultare il manuale del terminale host per determinare i parametri di comunicazione necessari (ad esempio parità, baud rate, ecc.) e, se necessario, modificare i parametri predefiniti per adattarli a quelli richiesti. La programmazione del lettore e può essere effettuata utilizzando:

- Software di programmazione Configurator Express™
- Guida di programmazione del lettore di codici a barre PowerScan®



**NOTA**

Vedere la sez. Riferimenti per ulteriori informazioni su come richiedere il software ed i manuali per questo prodotto.



**ATTENZIONE**

Consultare il manuale del terminale host per determinare se questo deve essere disattivato prima di collegare apparecchiature periferiche. Verificare che la procedura adottata sia corretta per evitare danni ai dispositivi o anomalie funzionali del sistema.

3. Collegare il cavo I/F alla porta appropriata del terminale host (consultare il manuale del terminale per determinare i requisiti hardware).

4. Collegare il cavo di alimentazione dell'adattatore di corrente al modulo base e quindi inserire l'adattatore in una presa di corrente (Figura 3). Il LED di alimentazione del modulo base si illumina quando l'unità è alimentata correttamente.

**Figura 3. Collegamento di alimentazione del modulo base**

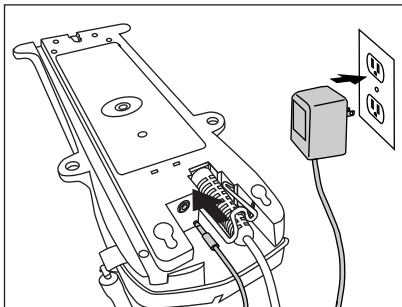

5. Accendere il terminale host.
6. Verificare la comunicazione verso il terminale puntando il lettore già collegato verso i codici a barre campione riportati al fondo di questo manuale e premere la levetta di comando (vedere Come effettuare la lettura per suggerimenti su come leggere i codici a barre). Verificare che il lettore/modulo base comunichino correttamente con il terminale host. In caso contrario, consultare la sezione Risoluzione dei problemi. Se l'invio dei dati è corretto, il sistema è pronto per l'utilizzo.

### **Collegamento del lettore al modulo base**

Per collegare un lettore ad un modulo base è sufficiente leggere il codice a barre di identificazione del modulo base prescelto. Durante la ricerca del giusto canale di comunicazione con il modulo base, il lettore emette un breve segnale acustico. Quando il modulo base risponde alla richiesta, il segnalatore acustico del lettore può emettere un segnale di "collegamento accettato" o "collegamento negato" (vedere la sezione Segnalazioni acustiche e luminose (LED) per ulteriori informazioni).

---

La configurazione di sistema del modulo base può essere scaricata automaticamente sul lettore. Questa funzione è configurabile e può essere disabilitata. Vedere il Manuale del sistema per ulteriori informazioni su tale funzione. Lo scaricamento dei dati determina un leggero ritardo del segnale di conferma del collegamento.



**ATTENZIONE**

**Poiché un lettore nuovo o sostitutivo può avere una configurazione personalizzata o una programmazione speciale, il trasferimento di una configurazione potenzialmente più datata da un modulo base può risultare indesiderabile. In questo caso, consultare il Manuale di sistema o il software di programmazione su schermo Configurator Express™ e valutare la possibilità di caricare la configurazione aggiornata del lettore sul modulo base prima di effettuare il collegamento.**

**Verifica del  
collegamento  
lettore/modulo  
base**

Puntare il lettore collegato verso un codice a barre campione riportato al fondo di questo manuale e premere la levetta di comando (vedere Come effettuare la lettura per suggerimenti sulla lettura dei codici a barre). Durante la lettura, osservare il LED TX/RX (trasmissione/ricezione) del modulo base e/o il LED verde del lettore. Mentre i due dispositivi comunicano, gli indicatori devono lampeggiare brevemente. Se non viene segnalata alcuna comunicazione, consultare la sezione Risoluzione dei problemi del Manuale di sistema.

Se il lettore è programmato opportunamente, la comunicazione può anche essere indicata da un secondo tono di conferma<sup>1</sup> emesso dopo il segnale di lettura corretta. Se dopo un segnale di "lettura corretta" viene emesso un segnale di errore trasmissione (trillo) anziché un singolo tono di ricezione, significa che probabilmente si è verificato un errore di comunicazione tra i dispositivi<sup>2</sup>. In tale evenienza, consultare le sezioni Utilizzo di PowerScan RF e Risoluzione dei problemi per le opportune procedure da adottare.

- 
1. Vedere Segnalazioni acustiche e luminose (LED) per ulteriori informazioni sui toni emessi dal segnalatore acustico.
  2. Un "trillo" viene emesso anche quando il modulo base è configurato diversamente rispetto al lettore o quando l'interfaccia del sistema non supporta la simbologia (tipo di codice a barre) di cui viene effettuata la lettura.

## Utilizzo di PowerScan RF

Questa sezione descrive i seguenti argomenti:

- Caricamento e manutenzione della batteria
- Come effettuare la lettura
- Segnalazioni acustiche e luminose (LED)

### Caricamento e manutenzione della batteria



**NOTA**

Quando il lettore è in uso, la condizione di batteria scarica viene indicata attraverso una segnalazione ripetuta di doppio lampeggio del LED verde del lettore ogni volta che si preme la levetta di comando prima che il laser sia attivato.

Questa segnalazione può essere disabilitata mediante programmazione speciale. Vedere Segnalazioni acustiche e luminose (LED) per ulteriori informazioni.

Collocare il lettore sul modulo base come indicato in Figura 4, verificando che la batteria risulti correttamente innestata sui contatti metallici del modulo. Il LED di carica del modulo base lampeggia per indicare che la batteria è sotto carica.

**Figura 4. Caricamento della batteria**

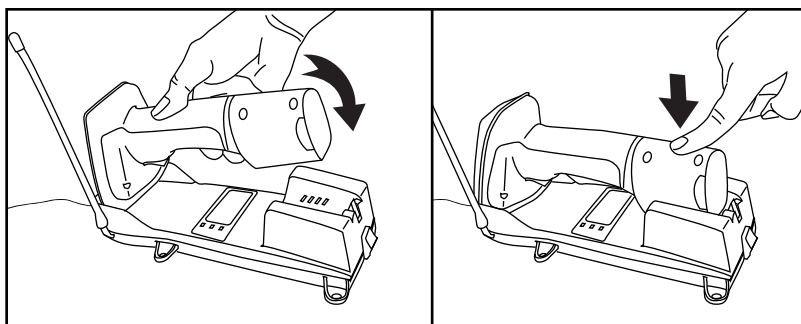

---

Un lampeggio rapido indica che il caricamento avviene correttamente. Il caricamento viene effettuato rapidamente quando la temperatura della batteria è compresa tra 10 °C e 46 °C e/o la carica della batteria oscilla tra 2.0 e 3.2V. Il tempo di caricamento è inferiore a 4,2 ore. Il caricamento rapido termina con la batteria approssimativamente al 90-95% della sua capacità. Il LED di carica resta acceso stabilmente con carica di mantenimento o al completamento del ciclo di carica.

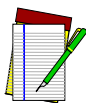

**NOTA**

**È possibile mettere un lettore sotto carica sul modulo base e utilizzare al tempo stesso un altro lettore.**



**NOTA**

**La batteria non può caricarsi se ha una temperatura inferiore a 0° C. Se la batteria inserita sul modulo base è troppo fredda, il LED di carica non si illumina.**

Le batterie all'idrato di nickel-metallo (NiMH) mantengono la carica più a lungo se vengono scaricate almeno una volta alla settimana. Per ottenere il massimo numero di cicli di carica/scarica delle batterie ricaricabili, è necessario che si verifichino le reazioni chimiche corrispondenti. Se la batteria viene rimossa dal lettore per essere immagazzinata, questa deve essere completamente carica. Le batterie perdono la capacità di mantenere la carica se inutilizzate per lunghi periodi di tempo (settimane, mesi o più).

Tipicamente, le batterie fornite hanno una carica pari al 30% della capacità. Per garantire il massimo rendimento, caricare completamente la batteria prima dell'utilizzo.

Conservare le batterie in un luogo fresco ed asciutto. Non lasciare la batteria alla luce diretta del sole o a temperature inferiori a 0° C o superiori a 38° C.

## **Smaltimento delle batterie**

Attualmente non esistono normative internazionali per lo smaltimento delle batterie NiMH, perciò quando queste non sono più in grado di mantenere la carica, possono essere smaltite nel modo più appropriato, preferibilmente presso un centro di riciclaggio.



## Caricabatterie a 4 vani

Se avete un caricabatterie a 4 vani, le batterie vengono inserite per il caricamento come indicato in Figura 5. Con questo accessorio è possibile effettuare una carica rapida del 90% in appena due ore, la metà del tempo richiesto per il caricamento sul modulo base. I LED di ogni vano del caricabatterie agiscono allo stesso modo del LED di carica del modulo base, cioè lampeggio rapido per indicare l'esecuzione della carica rapida e luce fissa con carica di mantenimento o al termine del ciclo rapido di carica.



### NOTA

Se inserendo una batteria sul caricabatterie a 4 vani non si accende alcun LED, probabilmente la batteria è troppo fredda. Per potersi caricare, le batterie devono essere ad una temperatura di 0° C o superiore. Non tentate di caricare batterie fredde poiché esse possono ostacolare il caricamento di altre batterie già presenti nel dispositivo.

Figura 5. Utilizzo del caricabatterie a 4 vani.

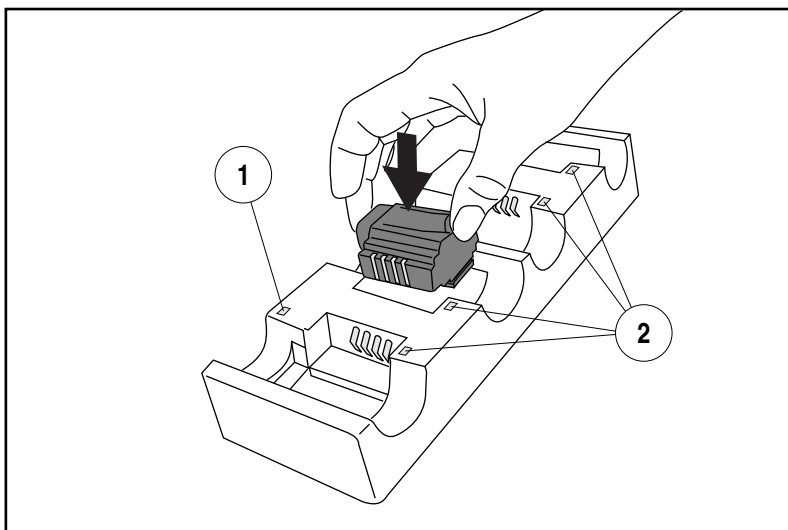

1. LED di alimentazione

2. LED di carica

## Come effettuare la lettura

La Figura 6 illustra alcuni suggerimenti per ottenere i migliori risultati di lettura:

1. Il lettore deve essere puntato verso il codice a barre in modo leggermente inclinato. Non tenere il lettore perpendicolare al codice a barre.
2. Il raggio laser deve attraversare l'intero codice a barre. Il lettore non può leggere correttamente se non effettua la scansione dell'intero codice a barre.

**Figura 6. Suggerimenti per eseguire la lettura**

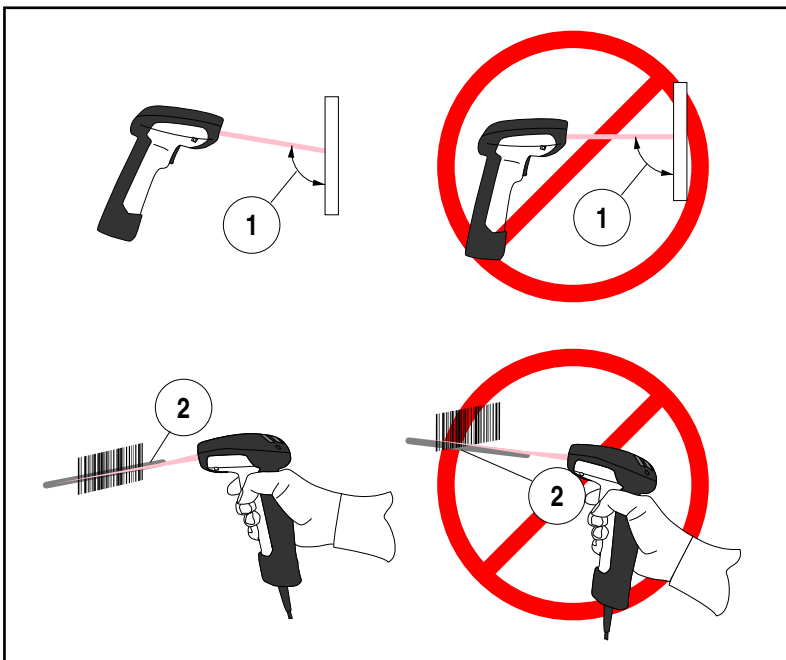

## Profondità di campo

Attualmente il lettore è disponibile in quattro modelli. In base al modello, il lettore deve essere tenuto ad una distanza appropriata dal codice a barre per ottenere i migliori risultati di lettura. I diagrammi riportati di seguito forniscono informazioni sulla profondità di campo di ogni modello per la lettura di codici a barre di tipo A e Code 39: standard (SR), alta densità (HD), lungo raggio (LR) e raggio extra (ELR).

## Definizione di "mil"

Un "mil" corrisponde a 0,254 millimetri. Relativamente alle illustrazioni di questa sezione, un "mil" rappresenta l'ampiezza minima di un singolo elemento del codice a barre. Pertanto, un codice a barre da 5 mil contiene elementi di ampiezza minima pari a 5 "mil" (0,127 mm).

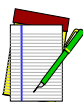

### NOTA

Le misure si basano su modelli SR configurati con angolo di scansione standard di 28° (in contrapposizione alla configurazione ad angolo ristretto di 14°). Fare riferimento al Manuale di programmazione per ulteriori informazioni sulla configurazione ad angolo ristretto. Le specifiche possono essere modificate senza preavviso.

Figura 7. Profondità di campo (SR)

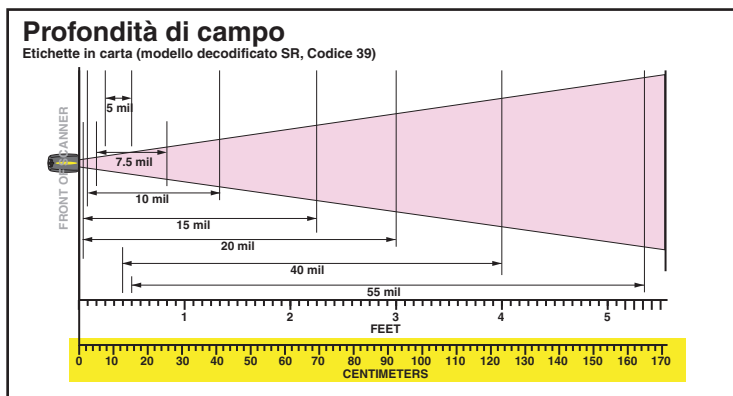



**NOTA**

Vedere la sezione Definizione di "mil" per ulteriori informazioni sull'interpretazione di questo grafico. Le misure si basano su modelli HD configurati con angolo di scansione standard di 28° (in contrapposizione alla configurazione ad angolo ristretto di 14°). Fare riferimento al Manuale di programmazione per ulteriori informazioni sulla configurazione ad angolo ristretto.

Le specifiche possono variare senza preavviso.

**Figura 8. Profondità di campo (HD)**

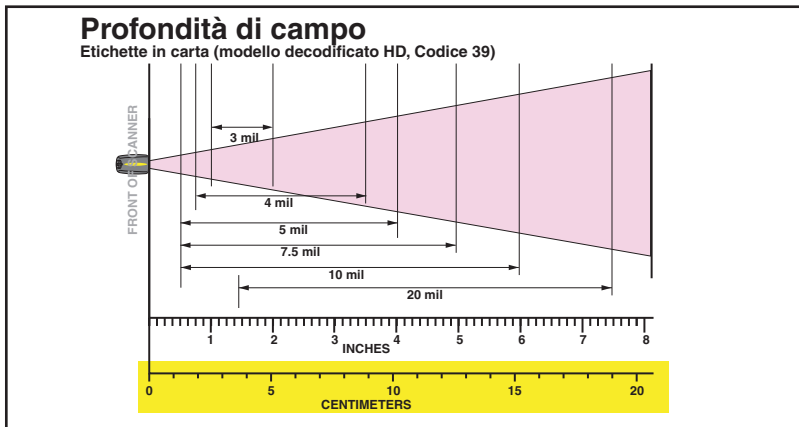



Vedere la sezione Definizione di "mil" per ulteriori informazioni sull'interpretazione di questo grafico. Le misure si basano su modelli HD configurati con angolo di scansione standard di 28° (in contrapposizione alla configurazione ad angolo ristretto di 14°). Fare riferimento al Manuale di programmazione per ulteriori informazioni sulla configurazione ad angolo ristretto.

**NOTA**

Le specifiche possono variare senza preavviso.

**Figura 9. Profondità di campo (LR)**

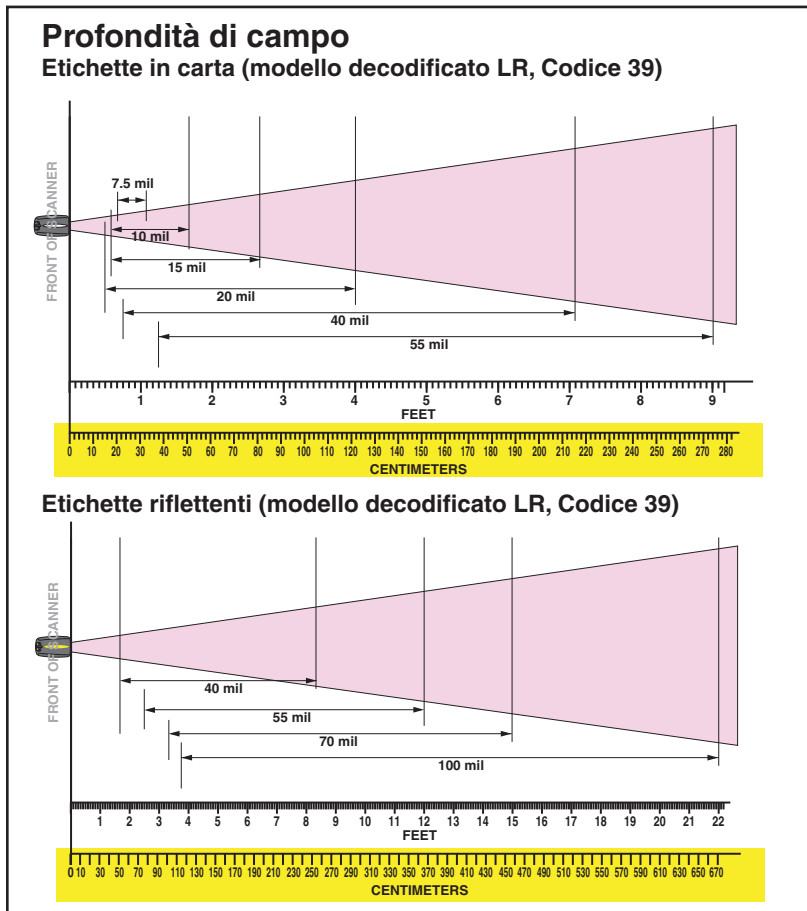



Vedere la sezione Definizione di "mil" per ulteriori informazioni sull'interpretazione di questo grafico. Le misure si basano su modelli XLR configurati con angolo di scansione di 10°.

**NOTA**

Le specifiche possono variare senza preavviso.

**Figura 10. Profondità di campo (XLR)**

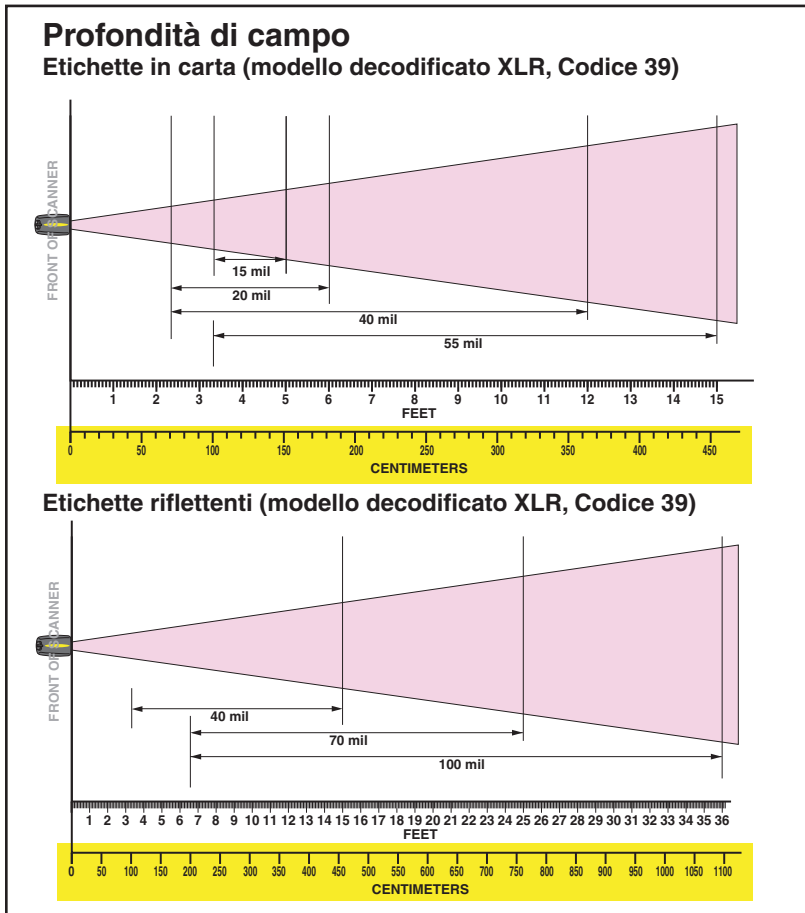





## Segnalazioni acustiche e luminose (LED)

Gli indicatori LED del modulo base ed i LED e il segnalatore acustico del lettore vengono utilizzati per segnalare lo stato operativo del sistema e per fornire altre indicazioni utili. Le tabelle che seguono riportano le funzioni predefinite di ogni indicatore.

	<p><b>Alcune segnalazioni acustiche o luminose possono essere disabilitate o modificate attraverso la programmazione del lettore. Le tabelle riportano il comportamento predefinito degli indicatori e le righe con sfondo colorato corrispondono alle funzioni programmabili.</b></p>
<b>NOTA</b>	

**Tabella 1. Funzioni del LED verde del lettore**

Indicazione	Durata	Significato
Disattivato	100ms acceso, 900 ms spento 	Il lettore è stato disattivato
Lettura effettuata	500 ms acceso 	Codice a barre letto e decodificato.
Modalità programmazione	500ms acceso, 500 ms spento lampeggio continuo. 	Il lettore è in modalità programmazione.
Unità FRU (Field Replaceable Unit)	Variabile. Accensione prolungata seguita da lampeggi multipli brevi. 	Permette ai tecnici riparatori di identificare gli errori dell'unità FRU.
Batteria scarica	100 ms acceso, 350 ms spento, per due volte 	Si verifica quando si preme la levetta di comando prima che il laser sia attivato. Indica che la batteria deve essere ricaricata.





**Tabella 2. Funzioni del LED giallo del lettore**

Indicazione	Durata	Significato
Laser attivo	<p>Acceso</p> 	Il LED giallo si illumina ogni volta che il laser è attivo.



**Tabella 3. Funzioni del segnalatore acustico del lettore**



Segnalazione	Durata	Significato
Lettore non collegato	<p>6 suoni di 20 ms ad intervalli di 20 ms</p> 	Indica che il codice a barre è stato letto prima che il lettore fosse collegato al modulo base.
Lettura corretta	<p>100 ms (breve)</p> <p style="text-align: center;"> </p> <p>250 ms (medio)</p> <p style="text-align: center;">■</p> <p>500 ms (lungo)</p> <p style="text-align: center;">▬</p>	Sono disponibili tre funzioni programmabili. Indica che il codice a barre è stato letto e decodificato.
Lettura parziale	<p>20 ms</p> <p style="text-align: center;"> </p>	Suono molto breve (bip) emesso quando viene letto correttamente uno dei codici di una coppia di codici a barre.
Riconoscimento modulo base	<p>100 ms (breve)</p> <p style="text-align: center;"> </p> <p>250 ms (medio)</p> <p style="text-align: center;">■</p> <p>500 ms (lungo)</p> <p style="text-align: center;">▬</p>	Indica la corretta trasmissione del codice a barre al terminale host (configurabile), un corretto cambio di canale o una corretta trasmissione di una nuova configurazione al terminale host.



Segnalazione	Durata	Significato
Errore di trasmissione	Alto, basso, alto, basso 	Indica che la trasmissione al terminale non è andata a buon fine.
Connessione	Basso, medio, alto. 	Indica che il lettore si è connesso correttamente al modulo base.
Disconnessione	Alto, medio, basso 	Indica che il lettore si è disconnesso correttamente dal modulo base.
Unità FRU	Variabile. Consiste in un lungo segnale seguito da segnali brevi multipli. 	Permette ai tecnici di identificare gli errori di unità FRU.

**Tabella 4. Funzioni dei LED del modulo base**

Indicazione	Durata	Significato
TX/RX (trasmissione / ricezione)	Acceso per un tempo variabile. <sup>a</sup> 	Indica comunicazione da/verso il modulo base.
	Lampeggio rapido continuo all'accensione. 	Indica un guasto del circuito radio.
	Variabile. Consiste in una lunga accensione seguita da lampeggi brevi multipli. 	Permette ai tecnici di identificare gli errori di unità FRU.

Indicazione	Durata	Significato
Carica (batteria)	Lampeggio continuo 	Quando il lettore è inserito nel modulo base, indica che la batteria si è in fase di carica rapida.
	Acceso 	Quando il lettore è inserito nel modulo base, indica che la batteria è quasi o completamente carica.
	Spento	Il lettore non è presente oppure è inserito male nel modulo. Inoltre, può indicare che la batteria è al di sotto di 0° C (troppo fredda per caricarsi).
Alimentazione	Acceso 	Indica che l'unità è alimentata.

- a. Il LED resta acceso mentre l'unità analizza il codice che richiede un'operazione TX/RX. La durata di accensione dipende dalla lunghezza del messaggio.

### Simbologie abilitate

Le simbologie abilitate di codici a barre predefinite dal costruttore sono:

- Code 39 (C39)
- Code 128 (C128)
- Interleaved 2 of 5 (I 2 of 5)

Il lettore deve risultare già pre-programmato con queste impostazioni predefinite, tranne che nei seguenti casi:

...il lettore è stato programmato dal costruttore con impostazioni speciali richieste dal cliente

...l'utente ha apportato modifiche alla programmazione del lettore.

## Scansione avanzata per codici a barre di difficile lettura

I lettori a decodifica possono essere programmati per la lettura di codici a barre di qualità molto scadente attivando la decodifica avanzata Quadrologic II™. Per attivare questa funzione, consultare la Guida di programmazione.

La programmazione del lettore può essere effettuata anche mediante il PC e il kit di programmazione Configurator Express™.



NOTA

Informazioni su manuali, kit e software di programmazione per questo prodotto sono disponibili sul nostro sito web (vedi retrocopertina).

### Figura 11. Etichette e nomenclatura del lettore

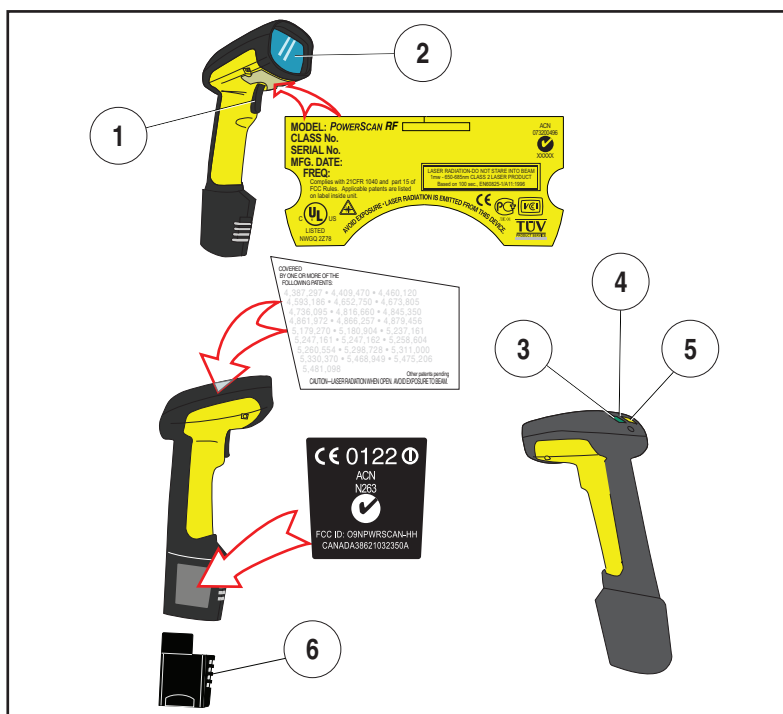

- |                          |               |
|--------------------------|---------------|
| 1. Levetta di comando    | 4. Gancio     |
| 2. Finestra di scansione | 5. LED giallo |
| 3. LED verde             | 6. Batteria   |



**NOTA**

La Figura 11 illustra SOLO la posizione dell'etichetta. Per le normative vigenti, brevetti e altre informazioni pertinenti, vedere le etichette sul prodotto o consultare il rivenditore o un centro di assistenza.

## Avvertenze sul laser

Il lettore di codici a barre PowerScan RF è certificato negli Stati Uniti per la conformità ai requisiti dello standard DHHS/CRH 21CFR Subchapter J for Class II laser products (SR and LR) and Class IIIa (XLR).

I prodotti di classe II e IIIa non sono considerati pericolosi. Il lettore è dotato di un laser VLD (Visible Laser Diode) con una lunghezza d'onda di 650-670 nanometri ed è progettato in modo tale da non consentire l'esposizione a livelli pericolosi di luce laser durante il normale utilizzo, la manutenzione o gli interventi di assistenza.



**ATTENZIONE**

**Nella improbabile evenienza che il laser emetta un fascio concentrato e brillante anziché una linea di scansione, non guardare direttamente il fascio luminoso né cercare di riparare il dispositivo. Interrompere l'operazione e consegnare il dispositivo al rivenditore. Nota: in modalità Marker Beam, l'unità emette un breve fascio di puntamento seguito dalla normale linea di scansione e tale comportamento non è da considerarsi anomalo.**



**ATTENZIONE**

**Non aprire o manipolare i componenti nella cavità ottica. L'apertura o la manipolazione di tali elementi da parte di personale non autorizzato può costituire una violazione delle normative di sicurezza sull'utilizzo dei laser. Il sistema ottico può essere riparato esclusivamente dal costruttore.**



**NOTA**

**Il lettore PowerScan<sup>®</sup> RF deve essere utilizzato congiuntamente ad un modulo base modello PowerScan RF.**

---

## Disturbi in radiofrequenza

Questo dispositivo è conforme alla sez. 15 delle norme FCC. L'utilizzo è subordinato alle due condizioni seguenti:

1. Il dispositivo non deve causare interferenze dannose, e
2. Il dispositivo deve sopportare le interferenze captate, incluse quelle che possono determinare un funzionamento anomalo.

Questo dispositivo digitale di Classe A è conforme alle normative canadesi ICES-003.

Cet appareil numérique de classe A est conforme à la norme NMB-003 du Canada.

Questa apparecchiatura è stata collaudata e giudicata conforme ai limiti per i dispositivi digitali di Classe B, descritti nella sez. 15 delle norme FCC. Tali limiti sono fissati per fornire una ragionevole protezione da disturbi dannosi in un'installazione residenziale. Questa apparecchiatura genera, utilizza e può irradiare radiofrequenze e, se non installata ed utilizzata secondo le istruzioni fornite, può generare interferenze dannose sulle trasmissioni radio.

Comunque, non è escluso che in particolari installazioni non possano verificarsi interferenze. Nel caso in cui questo dispositivo provochi disturbi dannosi sulle trasmissioni radiotelevisive, condizione rilevabile accendendo e quindi spegnendo il dispositivo, l'operatore deve cercare di eliminare l'interferenza adottando una o più delle seguenti contromisure:

- Orientare o collocare diversamente l'antenna ricevente.
- Aumentare la distanza tra il dispositivo e il ricevitore.
- Collegare il dispositivo ad una presa di corrente di un circuito diverso da quello a cui è collegato il ricevitore.
- Consultare il rivenditore od un tecnico radio/tv qualificato.

---

## Manutenzione

Il vetro del lettore deve essere pulito saltuariamente per rimuovere tracce di sporcizia, polvere ed altre impurità. Per ottenere un funzionamento ottimale, pulire la finestra di scansione con un panno morbido o una salvietta per occhiali inumidita con alcool isopropilico (o equivalente). Vedere la Figura 12. Anche il corpo del lettore può essere pulito con la stessa modalità.

**Figura 12. Pulizia della finestra di scansione**

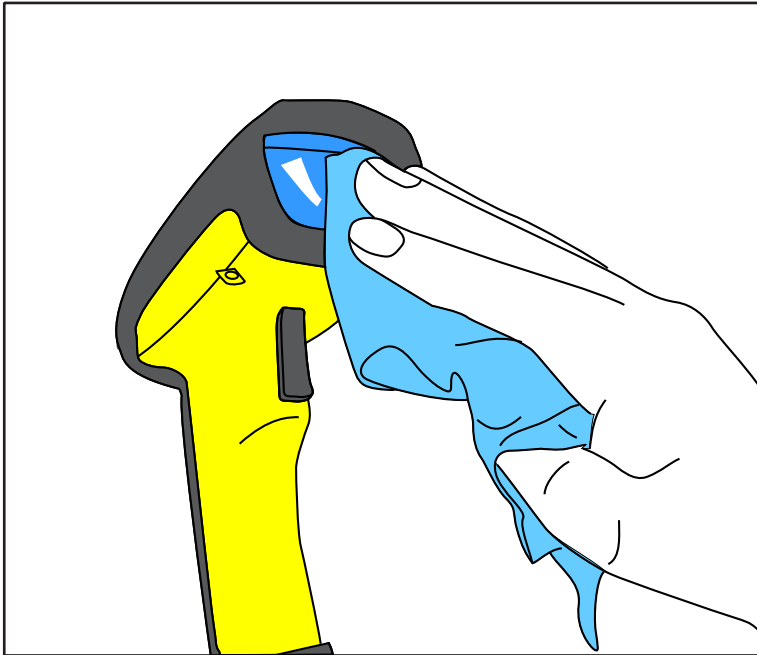

---

## Risoluzione dei problemi

Provate ad eliminare eventuali malfunzionamenti del sistema di lettura in radiofrequenza effettuando i seguenti controlli:

- Per il sistema RF, verificare che:
- La batteria sia carica. Vedere “Caricamento e manutenzione della batteria” a pag. 95.
- La batteria sia correttamente installata. Vedere “Installazione della batteria” a pag. 90.
- Il lettore sia collegato al modulo base prescelto. Vedere “Collegamento del lettore al modulo base” a pag. 93.
- Il lettore si trovi a distanza adeguata dal modulo base, senza ostacoli considerevoli tra le unità radio, come muri spessi o macchinari pesanti (al momento della redazione, la distanza massima di visibilità è di circa 45 m).
- Non vi siano interferenze locali di segnale con altre apparecchiature azionate mediante radiofrequenze. Consultare la sezione relativa alla selezione di canali alternativi del Manuale di sistema.
- Il modulo base sia acceso. Verificare eventuali malfunzionamenti dell'adattatore CA del modulo base utilizzando un adattatore di provata efficienza.
- Il cavo di interfaccia con il modulo base sia collegato saldamente al terminale host. Consultare il responsabile del supporto tecnico o il manuale del sistema host per determinare la connessione appropriata per il lettore. Se necessario, verificare il funzionamento del cavo di interfaccia utilizzando un cavo di provata efficienza.

Se il problema interessa la scansione, verificare che.....

- I codici a barre siano di qualità adeguata. Per una precisa identificazione dei dettagli delle etichette è possibile munirsi di appositi verificatori disponibili presso il rivenditore. I codici a barre danneggiati (piegati, con sbavature d'inchiostro o strappati) possono rendere difficoltosa o impossibile la lettura. Se il problema sembra essere imputabile alla qualità del codice a barre, verificare se il lettore riesce a leggere uno dei codici campione riportati nelle pagine successive.
- Le impostazioni programmabili di decodifica avanzata Quadralogic II™ siano configurate in modo ottimale per il sistema.

---

(Vedere “Scansione avanzata per codici a barre di difficile lettura” a pag. 107.)

## Codici a barre campione

Utilizzare questi codici a barre di riferimento per verificare la funzionalità del lettore nella lettura delle diverse simbologie rappresentate.

Code 128



Code 39



Interleaved 2 of 5



Standard 2 of 5



Codabar



Code 93





MSI/Plessey



14476925 4

UPC-A



0 00112 23344 0

UPC-A con 2 cifre aggiuntive



0 60992 01118 7 4 9

UPC-A con 5 cifre aggiuntive



0 8029 51041 8 6 9 0 0 0

UPC-E



0 998875 0

EAN-8



0021 0126

EAN-13



1 101234 567891

---

# NOTE

## DECLARATION OF CONFORMITY



Datalogic hereby declares that the Equipment specified below has been tested and found compliant to the following Directives and Standards:

**Directives:** EMC 89/336/EEC  
Low Voltage 73/23/EEC  
R&TTE 1999/5/EC

**Standards:** EN 300 683:1997 - Radio  
EN 300 220-3:2000 - Radio Immunity  
EN 60950:2000 - ITE Safety  
EN 60825-1/A2:2001 - Laser Safety

**Equipment Type:** Barcode Scanning Equipment

**Product Model Name:** PowerScan RF Handheld Scanner and Base Station

**Placed into EU Service:** April 2007 under the Datalogic trademark. Jan. 2001 under the PSC trademark.

**Serial No. Sequence:** Handheld = Rxxxxxx Base Station = BSxxxxxx

**Responsible Manufacturer:** Datalogic Scanning, Inc. 959 Terry St. Eugene, OR USA

### Declaration of Conformity with Regard to the R&TTE Directive 1999/5/EC

English: This equipment is in compliance with the essential requirements & other relevant provisions of Directive 1999/5/EC.  
Nederlands: Deze apparatuur voldoet aan de essentiële vereisten en andere relevante voorzieningen van EU-richtlijn 1999/5/EC.  
Suomalainen: Tämä laite noudattaa direktiivin 1999/5/EC keskeisiä vaatimuksia ja sen muita olennaisia määräyksiä.  
Français: Cet équipement répond aux exigences et provisions de la Directive 1999/5/EC.  
Deutsch: Diese Geräte entsprechen den Anforderungen und anderen relevanten Bestimmungen der Richtlinie 1999/5/EC.  
Italiano: Questa apparecchiatura rispetta i requisiti essenziali e le altre clausole rilevanti della Direttiva 1999/5/CE.  
Dansk: Dette udstyret er i samsvar med de grundlæggende kravene og andre relevante forskrifter i 1999/5/EC-direktivet.  
Português: Este equipamento está de acordo com os requisitos essenciais e outras provisões relevantes da Diretiva 1999/5/EC.  
Español: Este equipo cumple con los requisitos esenciales y otras provisiones relevantes de la Directiva 1999/5/EC.  
Svenska: Denna utrustning uppfyller de väsentliga kraven och andra relevanta förordningar i Direktiv 1999/5/EC.  
Norsk: Dette utstyret er i samsvar med de grunnleggende krav og andre relevante bestemmelser i EU-direktiv 1999/5/EF  
Islenska: Þetta tæki er samkvæmt grunnkröfum og öðrum viðeigandi ákvaðum Tilskipunar 1999/5/CE.



### **Australia**

Datalogic Scanning Pty Ltd  
North Ryde, Australia  
Telephone: [61] (2) 9870 3200  
Fax: [61] (2) 9878 8688

### **France and Benelux**

Datalogic Scanning Sarl  
LES ULIS Cedex, France  
Telephone: [33].01.64.86.71.00  
Fax: [33].01.64.46.72.44

### **Germany**

Datalogic Scanning GmbH  
Darmstadt, Germany  
Telephone: 49 (0) 61 51/93 58-0  
Fax: 49 (0) 61 51/93 58 58

### **Italy**

Datalogic Scanning SpA  
Vimercate (MI), Italy  
Telephone: [39] (0) 39/62903.1  
Fax: [39] (0) 39/6859496

### **Japan**

Datalogic Scanning KK  
Shinagawa, Tokyo, Japan  
Telephone: 81 (0)3 3491 6761  
Fax: 81 (0)3 3491 6656

### **Latin America**

Datalogic Scanning, Inc  
Miami, Florida, USA  
Telephone: (305) 591-3222  
Fax: (305) 591-3007

### **Spain and Portugal**

Datalogic Scanning Sarl Sucursal en España  
Madrid, Spain  
Telephone: 34 91 746 28 60  
Fax: 34 91 742 35 33

### **United Kingdom**

Datalogic Scanning LTD  
Watford, England  
Telephone: 44 (0) 1923 809500  
Fax: 44 (0) 1923 809 505



[www.scanning.datalogic.com](http://www.scanning.datalogic.com)

### **Datalogic Scanning, Inc.**

959 Terry Street  
Eugene, OR 97402  
Telephone: (541) 683-5700  
Fax: (541) 345-7140

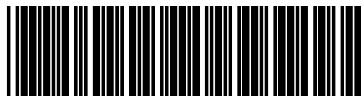

## Free Manuals Download Website

<http://myh66.com>

<http://usermanuals.us>

<http://www.somanuals.com>

<http://www.4manuals.cc>

<http://www.manual-lib.com>

<http://www.404manual.com>

<http://www.luxmanual.com>

<http://aubethermostatmanual.com>

Golf course search by state

<http://golfingnear.com>

Email search by domain

<http://emailbydomain.com>

Auto manuals search

<http://auto.somanuals.com>

TV manuals search

<http://tv.somanuals.com>