



Magellan[®] 1400i

Omni-Directional Imaging Scanner



Product Reference Guide

Datalogic Scanning, Inc.

959 Terry Street
Eugene, Oregon 97402
Telephone: (541) 683-5700
Fax: (541) 345-7140

An Unpublished Work - All rights reserved. No part of the contents of this documentation or the procedures described therein may be reproduced or transmitted in any form or by any means without prior written permission of Datalogic Scanning, Inc. or its subsidiaries or affiliates ("Datalogic" or "Datalogic Scanning"). Owners of Datalogic products are hereby granted a non-exclusive, revocable license to reproduce and transmit this documentation for the purchaser's own internal business purposes. Purchaser shall not remove or alter any proprietary notices, including copyright notices, contained in this documentation and shall ensure that all notices appear on any reproductions of the documentation.

Should future revisions of this manual be published, you can acquire printed versions by contacting your Datalogic representative. Electronic versions may either be downloadable from the Datalogic website (www.scanning.datalogic.com) or provided on appropriate media. If you visit our website and would like to make comments or suggestions about this or other Datalogic publications, please let us know via the "Contact Datalogic" page.

Disclaimer

Datalogic has taken reasonable measures to provide information in this manual that is complete and accurate, however, Datalogic reserves the right to change any specification at any time without prior notice.

Datalogic is a registered trademark of Datalogic S.p.A. and the Datalogic logo is a trademark of Datalogic S.p.A. all licensed to Datalogic Scanning, Inc. All other trademarks and trade names referred to herein are property of their respective owners.

This product may be covered by one or more of the following patents: 4603262 • 4639606 • 4652750 • 4672215 • 4699447 • 4709369 • 4749879 • 4786798 • 4792666 • 4794240 • 4798943 • 4799164 • 4820911 • 4845349 • 4861972 • 4861973 • 4866257 • 4868836 • 4879456 • 4939355 • 4939356 • 4943127 • 4963719 • 4971176 • 4971177 • 4991692 • 5001406 • 5015831 • 5019697 • 5019698 • 5086879 • 5115120 • 5144118 • 5146463 • 5179270 • 5198649 • 5200597 • 5202784 • 5208449 • 5210397 • 5212371 • 5212372 • 5214270 • 5229590 • 5231293 • 5232185 • 5233169 • 5235168 • 5237161 • 5237162 • 5239165 • 5247161 • 5256864 • 5258604 • 5258699 • 5260554 • 5274219 • 5296689 • 5298728 • 5311000 • 5327451 • 5329103 • 5330370 • 5347113 • 5347121 • 5371361 • 5382783 • 5386105 • 5389917 • 5410108 • 5420410 • 5422472 • 5426507 • 5438187 • 5440110 • 5440111 • 5446271 • 5446749 • 5448050 • 5463211 • 5475206 • 5475207 • 5479011 • 5481098 • 5491328 • 5493108 • 5504350 • 5508505 • 5512740 • 5541397 • 5552593 • 5557095 • 5563402 • 5565668 • 5576531 • 5581707 • 5594231 • 5594441 • 5598070 • 5602376 • 5608201 • 5608399 • 5612529 • 5629510 • 5635699 • 5641958 • 5646391 • 5661435 • 5664231 • 5666045 • 5671374 • 5675138 • 5682028 • 5686716 • 5696370 • 5703347 • 5705802 • 5714750 • 5717194 • 5723852 • 5750976 • 5767502 • 5770847 • 5786581 • 5786585 • 5787103 • 5789732 • 5796222 • 5804809 • 5814803 • 5814804 • 5821721 • 5822343 • 5825009 • 5834708 • 5834750 • 5837983 • 5837988 • 5852286 • 5864129 • 5869827 • 5874722 • 5883370 • 5905249 • 5907147 • 5923023 • 5925868 • 5929421 • 5945670 • 5959284 • 5962838 • 5979769 • 6000619 • 6006991 • 6012639 • 6016135 • 6024284 • 6041374 • 6042012 • 6045044 • 6047889 • 6047894 • 6056198 • 6065676 • 6069696 • 6073849 • 6073851 • 6094288 • 6112993 • 6129279 • 6129282 • 6134039 • 6142376 • 6152368 • 6152372 • 6155488 • 6166375 • 6169614 • 6173894 • 6176429 • 6188500 • 6189784 • 6213397 • 6223986 • 6230975 • 6230976 • 6237852 • 6244510 • 6259545 • 6260763 • 6266175 • 6273336 • 6276605 • 6279829 • 6290134 • 6290135 • 6293467 • 6303927 • 6311895 • 6318634 • 6328216 • 6332576 • 6332577 • 6343741 • 6454168 • 6478224 • 6568598 • 6578765 • 6705527 • 6974084 • 6991169 • 7051940 • 7170414 • 7172123 • 7201322 • 7204422 • 7215493 • 7224540 • 7234641 • 7243850 • 601 26 118.6 • AU703547 • D312631 • D313590 • D320011 • D320012 • D323492 • D330707 • D330708 • D330709 • D330710 • D330711 • D330712 • D330713 • D330714 • D330715 • D330716 • D330717 • D330718 • D330719 • D330720 • D330721 • D330722 • D330723 • D330724 • D330725 • D330726 • D330727 • D330728 • D330729 • D330730 • D330731 • D330732 • D330733 • D330734 • D330735 • D330736 • D330737 • D330738 • D330739 • D330740 • D330741 • D330742 • D330743 • D330744 • D330745 • D330746 • D330747 • D330748 • D330749 • D330750 • D330751 • D330752 • D330753 • D330754 • D330755 • D330756 • D330757 • D330758 • D330759 • D330760 • D330761 • D330762 • D330763 • D330764 • D330765 • D330766 • D330767 • D330768 • D330769 • D330770 • D330771 • D330772 • D330773 • D330774 • D330775 • D330776 • D330777 • D330778 • D330779 • D330780 • D330781 • D330782 • D330783 • D330784 • D330785 • D330786 • D330787 • D330788 • D330789 • D330790 • D330791 • D330792 • D330793 • D330794 • D330795 • D330796 • D330797 • D330798 • D330799 • D330800 • D330801 • D330802 • D330803 • D330804 • D330805 • D330806 • D330807 • D330808 • D330809 • D330810 • D330811 • D330812 • D330813 • D330814 • D330815 • D330816 • D330817 • D330818 • D330819 • D330820 • D330821 • D330822 • D330823 • D330824 • D330825 • D330826 • D330827 • D330828 • D330829 • D330830 • D330831 • D330832 • D330833 • D330834 • D330835 • D330836 • D330837 • D330838 • D330839 • D330840 • D330841 • D330842 • D330843 • D330844 • D330845 • D330846 • D330847 • D330848 • D330849 • D330850 • D330851 • D330852 • D330853 • D330854 • D330855 • D330856 • D330857 • D330858 • D330859 • D330860 • D330861 • D330862 • D330863 • D330864 • D330865 • D330866 • D330867 • D330868 • D330869 • D330870 • D330871 • D330872 • D330873 • D330874 • D330875 • D330876 • D330877 • D330878 • D330879 • D330880 • D330881 • D330882 • D330883 • D330884 • D330885 • D330886 • D330887 • D330888 • D330889 • D330890 • D330891 • D330892 • D330893 • D330894 • D330895 • D330896 • D330897 • D330898 • D330899 • D330900 • D330901 • D330902 • D330903 • D330904 • D330905 • D330906 • D330907 • D330908 • D330909 • D330910 • D330911 • D330912 • D330913 • D330914 • D330915 • D330916 • D330917 • D330918 • D330919 • D330920 • D330921 • D330922 • D330923 • D330924 • D330925 • D330926 • D330927 • D330928 • D330929 • D330930 • D330931 • D330932 • D330933 • D330934 • D330935 • D330936 • D330937 • D330938 • D330939 • D330940 • D330941 • D330942 • D330943 • D330944 • D330945 • D330946 • D330947 • D330948 • D330949 • D330950 • D330951 • D330952 • D330953 • D330954 • D330955 • D330956 • D330957 • D330958 • D330959 • D330960 • D330961 • D330962 • D330963 • D330964 • D330965 • D330966 • D330967 • D330968 • D330969 • D330970 • D330971 • D330972 • D330973 • D330974 • D330975 • D330976 • D330977 • D330978 • D330979 • D330980 • D330981 • D330982 • D330983 • D330984 • D330985 • D330986 • D330987 • D330988 • D330989 • D330990 • D330991 • D330992 • D330993 • D330994 • D330995 • D330996 • D330997 • D330998 • D330999 • D331000 • D331001 • D331002 • D331003 • D331004 • D331005 • D331006 • D331007 • D331008 • D331009 • D331010 • D331011 • D331012 • D331013 • D331014 • D331015 • D331016 • D331017 • D331018 • D331019 • D331020 • D331021 • D331022 • D331023 • D331024 • D331025 • D331026 • D331027 • D331028 • D331029 • D331030 • D331031 • D331032 • D331033 • D331034 • D331035 • D331036 • D331037 • D331038 • D331039 • D331040 • D331041 • D331042 • D331043 • D331044 • D331045 • D331046 • D331047 • D331048 • D331049 • D331050 • D331051 • D331052 • D331053 • D331054 • D331055 • D331056 • D331057 • D331058 • D331059 • D331060 • D331061 • D331062 • D331063 • D331064 • D331065 • D331066 • D331067 • D331068 • D331069 • D331070 • D331071 • D331072 • D331073 • D331074 • D331075 • D331076 • D331077 • D331078 • D331079 • D331080 • D331081 • D331082 • D331083 • D331084 • D331085 • D331086 • D331087 • D331088 • D331089 • D331090 • D331091 • D331092 • D331093 • D331094 • D331095 • D331096 • D331097 • D331098 • D331099 • D331100 • D331101 • D331102 • D331103 • D331104 • D331105 • D331106 • D331107 • D331108 • D331109 • D331110 • D331111 • D331112 • D331113 • D331114 • D331115 • D331116 • D331117 • D331118 • D331119 • D331120 • D331121 • D331122 • D331123 • D331124 • D331125 • D331126 • D331127 • D331128 • D331129 • D331130 • D331131 • D331132 • D331133 • D331134 • D331135 • D331136 • D331137 • D331138 • D331139 • D331140 • D331141 • D331142 • D331143 • D331144 • D331145 • D331146 • D331147 • D331148 • D331149 • D331150 • D331151 • D331152 • D331153 • D331154 • D331155 • D331156 • D331157 • D331158 • D331159 • D331160 • D331161 • D331162 • D331163 • D331164 • D331165 • D331166 • D331167 • D331168 • D331169 • D331170 • D331171 • D331172 • D331173 • D331174 • D331175 • D331176 • D331177 • D331178 • D331179 • D331180 • D331181 • D331182 • D331183 • D331184 • D331185 • D331186 • D331187 • D331188 • D331189 • D331190 • D331191 • D331192 • D331193 • D331194 • D331195 • D331196 • D331197 • D331198 • D331199 • D331200 • D331201 • D331202 • D331203 • D331204 • D331205 • D331206 • D331207 • D331208 • D331209 • D331210 • D331211 • D331212 • D331213 • D331214 • D331215 • D331216 • D331217 • D331218 • D331219 • D331220 • D331221 • D331222 • D331223 • D331224 • D331225 • D331226 • D331227 • D331228 • D331229 • D331230 • D331231 • D331232 • D331233 • D331234 • D331235 • D331236 • D331237 • D331238 • D331239 • D331240 • D331241 • D331242 • D331243 • D331244 • D331245 • D331246 • D331247 • D331248 • D331249 • D331250 • D331251 • D331252 • D331253 • D331254 • D331255 • D331256 • D331257 • D331258 • D331259 • D331260 • D331261 • D331262 • D331263 • D331264 • D331265 • D331266 • D331267 • D331268 • D331269 • D331270 • D331271 • D331272 • D331273 • D331274 • D331275 • D331276 • D331277 • D331278 • D331279 • D331280 • D331281 • D331282 • D331283 • D331284 • D331285 • D331286 • D331287 • D331288 • D331289 • D331290 • D331291 • D331292 • D331293 • D331294 • D331295 • D331296 • D331297 • D331298 • D331299 • D331300 • D331301 • D331302 • D331303 • D331304 • D331305 • D331306 • D331307 • D331308 • D331309 • D331310 • D331311 • D331312 • D331313 • D331314 • D331315 • D331316 • D331317 • D331318 • D331319 • D331320 • D331321 • D331322 • D331323 • D331324 • D331325 • D331326 • D331327 • D331328 • D331329 • D331330 • D331331 • D331332 • D331333 • D331334 • D331335 • D331336 • D331337 • D331338 • D331339 • D331340 • D331341 • D331342 • D331343 • D331344 • D331345 • D331346 • D331347 • D331348 • D331349 • D331350 • D331351 • D331352 • D331353 • D331354 • D331355 • D331356 • D331357 • D331358 • D331359 • D331360 • D331361 • D331362 • D331363 • D331364 • D331365 • D331366 • D331367 • D331368 • D331369 • D331370 • D331371 • D331372 • D331373 • D331374 • D331375 • D331376 • D331377 • D331378 • D331379 • D331380 • D331381 • D331382 • D331383 • D331384 • D331385 • D331386 • D331387 • D331388 • D331389 • D331390 • D331391 • D331392 • D331393 • D331394 • D331395 • D331396 • D331397 • D331398 • D331399 • D331400 • D331401 • D331402 • D331403 • D331404 • D331405 • D331406 • D331407 • D331408 • D331409 • D331410 • D331411 • D331412 • D331413 • D331414 • D331415 • D331416 • D331417 • D331418 • D331419 • D331420 • D331421 • D331422 • D331423 • D331424 • D331425 • D331426 • D331427 • D331428 • D331429 • D331430 • D331431 • D331432 • D331433 • D331434 • D331435 • D331436 • D331437 • D331438 • D331439 • D331440 • D331441 • D331442 • D331443 • D331444 • D331445 • D331446 • D331447 • D331448 • D331449 • D331450 • D331451 • D331452 • D331453 • D331454 • D331455 • D331456 • D331457 • D331458 • D331459 • D331460 • D331461 • D331462 • D331463 • D331464 • D331465 • D331466 • D331467 • D331468 • D331469 • D331470 • D331471 • D331472 • D331473 • D331474 • D331475 • D331476 • D331477 • D331478 • D331479 • D331480 • D331481 • D331482 • D331483 • D331484 • D331485 • D331486 • D331487 • D331488 • D331489 • D331490 • D331491 • D331492 • D331493 • D331494 • D331495 • D331496 • D331497 • D331498 • D331499 • D331500 • D331501 • D331502 • D331503 • D331504 • D331505 • D331506 • D331507 • D331508 • D331509 • D331510 • D331511 • D331512 • D331513 • D331514 • D331515 • D331516 • D331517 • D331518 • D331519 • D331520 • D331521 • D331522 • D331523 • D331524 • D331525 • D331526 • D331527 • D331528 • D331529 • D331530 • D331531 • D331532 • D331533 • D331534 • D331535 • D331536 • D331537 • D331538 • D331539 • D331540 • D331541 • D331542 • D331543 • D331544 • D331545 • D331546 • D331547 • D331548 • D331549 • D331550 • D331551 • D331552 • D331553 • D331554 • D331555 • D331556 • D331557 • D331558 • D331559 • D331560 • D331561 • D331562 • D331563 • D331564 • D331565 • D331566 • D331567 • D331568 • D331569 • D331570 • D331571 • D331572 • D331573 • D331574 • D331575 • D331576 • D331577 • D331578 • D331579 • D331580 • D331581 • D331582 • D331583 • D331584 • D331585 • D331586 • D331587 • D331588 • D331589 • D331590 • D331591 • D331592 • D331593 • D331594 • D331595 • D331596 • D331597 • D331598 • D331599 • D331600 • D331601 • D331602 • D331603 • D331604 • D331605 • D331606 • D331607 • D331608 • D331609 • D331610 • D331611 • D331612 • D331613 • D331614 • D331615 • D331616 • D331617 • D331618 • D331619 • D331620 • D331621 • D331622 • D331623 • D331624 • D331625 • D331626 • D331627 • D331628 • D331629 • D331630 • D331631 • D331632 • D331633 • D331634 • D331635 • D331636 • D331637 • D331638 • D331639 • D331640 • D331641 • D331642 • D331643 • D331644 • D331645 • D331646 • D331647 • D331648 • D331649 • D331650 • D331651 • D331652 • D331653 • D331654 • D331655 • D331656 • D331657 • D331658 • D331659 • D331660 • D331661 • D331662 • D331663 • D331664 • D331665 • D331666 • D331667 • D331668 • D331669 • D331670 • D331671 • D331672 • D331673 • D331674 • D331675 • D331676 • D331677 • D331678 • D331679 • D331680 • D331681 • D331682 • D331683 • D331684 • D331685 • D331686 • D331687 • D331688 • D331689 • D331690 • D331691 • D331692 • D331693 • D331694 • D331695 • D331696 • D331697 • D331698 • D331699 • D331700 • D331701 • D331702 • D331703 • D331704 • D331705 • D331706 • D331707 • D331708 • D331709 • D331710 • D331711 • D331712 • D331713 • D331714 • D331715 • D331716 • D331717 • D331718 • D331719 • D331720 • D331721 • D331722 • D331723 • D331724 • D331725 • D331726 • D331727 • D331728 • D331729 • D331730 • D331731 • D331732 • D331733 • D331734 • D331735 • D331736 • D331737 • D331738 • D331739 • D331740 • D331741 • D331742 • D331743 • D331744 • D331745 • D331746 • D331747 • D331748 • D331749 • D331750 • D331751 • D331752 • D331753 • D331754 • D331755 • D331756 • D331757 • D331758 • D331759 • D331760 • D331761 • D331762 • D331763 • D331764 • D331765 • D331766 • D331767 • D331768 • D331769 • D331770 • D331771 • D331772 • D331773 • D331774 • D331775 • D331776 • D331777 • D331778 • D331779 • D331780 • D331781 • D331782 • D331783 • D331784 • D331785 • D331786 • D331787 • D331788 • D331789 • D331790 • D331791 • D331792 • D331793 • D331794 • D331795 • D331796 • D331797 • D331798 • D331799 • D331800 • D331801 • D331802 • D331803 • D331804 • D331805 • D331806 • D331807 • D331808 • D331809 • D331810 • D331811 • D331812 • D331813 • D331814 • D331815 • D331816 • D331817 • D331818 • D331819 • D331820 • D331821 • D331822 • D331823 • D331824 • D331825 • D331826 • D331827 • D331828 • D331829 • D331830 • D331831 • D331832 • D331833 • D331834 • D331835 • D331836 • D331837 • D331838 • D331839 • D331840 • D331841 • D331842 • D331843 • D331844 • D331845 • D331846 • D331847 • D331848 • D331849 • D331850 • D331851 • D331852 • D331853 • D331854 • D331855 • D331856 • D331857 • D331858 • D331859 • D331860 • D331861 • D331862 • D331863 • D331864 • D331865 • D331866 • D331867 • D331868 • D331869 • D331870 • D331871 • D331872 • D331873 • D331874 • D331875 • D331876 • D331877 • D331878 • D331879 • D331880 • D331881 • D331882 • D331883 • D331884 • D331885 • D331886 • D331887 • D331888 • D331889 • D331890 • D331891 • D331892 • D331893 • D331894 • D331895 • D331896 • D331897 • D331898 • D331899 • D331900 • D331901 • D331902 • D331903 • D331904 • D331905 • D331906 • D331907 • D331908 • D331909 • D331910 • D331911 • D331912 • D331913 • D331914 • D331915 • D331916 • D33

Table of Contents

| | |
|---|------|
| About This Manual | 1-1 |
| Manual Conventions | 1-1 |
| Connecting the Scanner | 1-2 |
| Programming | 1-3 |
| Using the Programming Bar Codes | 1-3 |
| Resetting the Standard Product Defaults | 1-3 |
| LED and Beeper Indicators | 1-4 |
| Error Codes | 1-5 |
| Double Read Timeout | 2-1 |
| PDF Double Read Timeout | 2-2 |
| Label Gone Timeout | 2-4 |
| PDF Label Gone Timeout | 2-4 |
| Sleep Mode | 2-5 |
| LED and Beeper Indicators | 2-7 |
| Power On Alert | 2-7 |
| Good Read: When to Indicate | 2-8 |
| Good Read Beep Control | 2-9 |
| Good Read Beep Frequency | 2-9 |
| Good Read Beep Length | 2-10 |
| Good Read Beep Volume | 2-11 |
| Productivity Index Reporting (PIR) | 2-11 |
| Scanning Features | 2-12 |
| Aiming Pointer | 2-12 |
| Targeted Scanning Mode | 2-12 |
| Wake Up Intensity | 2-15 |
| Interface Selection | 3-3 |
| Interface Features | 3-7 |
| RS-232 Interface Features | 3-9 |
| ACK NAK Error Handling | 3-23 |
| IBM-USB Interface Features | 3-24 |
| IBM | 3-25 |
| Wand Emulation | 3-26 |
| Keyboard Wedge | 3-30 |
| USB Keyboard | 3-30 |
| Data Editing Overview | 4-1 |
| Please Keep In Mind... | 4-1 |
| Global Prefix/Suffix | 4-2 |
| AIM ID | 4-4 |
| Label ID | 4-5 |
| Case Conversion | 4-11 |
| Character Conversion | 4-12 |
| UPC-A | 5-1 |
| Disable/Enable UPC-A | 5-1 |
| Check Digit Transmission | 5-2 |
| Expand UPC-A to EAN-13 | 5-2 |
| Number System Transmission | 5-3 |
| UPC-A Minimum Reads | 5-3 |
| UPC-A In-store Minimum Reads | 5-4 |
| UPC-E | 5-5 |
| Disable/Enable UPC-E | 5-5 |
| Check Digit Transmission | 5-5 |
| Number System Digit | 5-6 |
| Expand UPC-E to UPC-A | 5-6 |
| Expand UPC-E to EAN13 | 5-7 |

| | |
|--|------|
| Minimum Reads | 5-7 |
| GTIN | 5-8 |
| Expand UPC/EAN to GTIN | 5-8 |
| EAN-13 | 5-9 |
| Disable/Enable EAN-13 | 5-9 |
| Check Digit Transmission | 5-9 |
| EAN-13 Flag 1 Character | 5-10 |
| ISBN | 5-10 |
| Minimum Reads | 5-11 |
| EAN-8 | 5-12 |
| Disable/Enable EAN-8 | 5-12 |
| Check Digit Transmission | 5-12 |
| Minimum Reads | 5-13 |
| Enable EAN Two-Label | 5-14 |
| Enable EAN Two-Label Combined | 5-14 |
| Add-ons | 5-15 |
| RSS-14 | 5-17 |
| Disable/Enable RSS-14 | 5-17 |
| RSS-14 UCC/EAN 128 Emulation | 5-17 |
| Minimum Reads | 5-18 |
| RSS-14 2D Component | 5-19 |
| RSS Expanded | 5-20 |
| Disable/Enable RSS Expanded | 5-20 |
| RSS Expanded UCC/EAN 128 Emulation | 5-20 |
| Length Control | 5-21 |
| RSS Expanded Length 1, Length 2 Programming Instructions | 5-22 |
| Minimum Reads | 5-23 |
| RSS Expanded 2D Component | 5-24 |
| RSS Limited | 5-24 |
| Disable/Enable RSS Limited | 5-24 |
| RSS Limited UCC/EAN 128 Emulation | 5-25 |
| Minimum Reads | 5-25 |
| RSS Limited 2D Component | 5-26 |
| Code 39 | 5-27 |
| Disable/Enable Code 39 | 5-27 |
| Check Character Calculation | 5-27 |
| Check Character Transmit | 5-28 |
| Start/Stop Characters | 5-28 |
| Code 39 Full ASCII | 5-29 |
| Length Control | 5-30 |
| Code 39 Length 1, Length 2 Programming Instructions | 5-31 |
| Quiet Zones | 5-31 |
| Code 39 Stitching | 5-32 |
| Minimum Reads | 5-32 |
| Pharmacode 39 | 5-33 |
| Disable/Enable Pharmacode 39 | 5-33 |
| Start/Stop Characters | 5-33 |
| Check Character Transmit | 5-34 |
| Code 128 and UCC/EAN 128 | 5-35 |
| Transmit Function Characters | 5-36 |
| Length Control | 5-37 |
| Code 128 Length 1, Length 2 Programming Instructions | 5-38 |
| Code 128 Conversion to Code 39 | 5-38 |
| Code 128 Stitching | 5-39 |
| Minimum Reads | 5-39 |
| Interleaved 2 of 5 | 5-40 |
| Disable/Enable Interleaved 2 of 5 | 5-40 |
| Check Digit Calculation | 5-40 |
| Check Digit Transmit | 5-41 |
| Length Control | 5-42 |

| | |
|--|------|
| Interleaved 2 of 5 Length 1, Length 2 Programming Instructions | 5-43 |
| Interleaved 2 of 5 Stitching | 5-44 |
| Minimum Reads | 5-45 |
| Codabar | 5-46 |
| Disable/Enable Codabar | 5-46 |
| Check Character Verification | 5-46 |
| Check Character Transmit | 5-47 |
| Length Control | 5-48 |
| Codabar Length 1, Length 2 Programming Instructions | 5-49 |
| Start/Stop Character Type | 5-50 |
| Start/Stop Character Transmission | 5-50 |
| Start/Stop Character Match | 5-51 |
| Codabar Stitching | 5-51 |
| Minimum Reads | 5-52 |
| Code 93 | 5-53 |
| Disable/Enable Code 93 | 5-53 |
| Length Control | 5-54 |
| Code 93 Length 1, Length 2 Programming Instructions | 5-55 |
| Code 93 Stitching | 5-56 |
| Minimum Reads | 5-56 |
| MSI/Plessey | 5-57 |
| Disable/Enable MSI/Plessey | 5-57 |
| Check Digit Verification | 5-57 |
| Check Digit Transmit | 5-58 |
| Number of Check Characters | 5-58 |
| Length Control | 5-59 |
| MSI/Plessey Length 1, Length 2 Programming Instructions | 5-60 |
| MSI/Plessey Stitching | 5-61 |
| Minimum Reads | 5-62 |
| Standard 2 of 5 | 5-63 |
| Disable/Enable Standard 2 of 5 | 5-63 |
| Check Digit Verification | 5-63 |
| Check Digit Transmit | 5-64 |
| Length Control | 5-65 |
| Standard 2 of 5 Length 1, Length 2 Programming Instructions | 5-66 |
| Standard 2 of 5 Stitching | 5-67 |
| Minimum Reads | 5-68 |
| PDF417 | 5-69 |
| Disable/Enable PDF417 | 5-69 |
| PDF417 Minimum Reads | 5-69 |
| Length Control | 5-70 |
| PDF417 Length 1, Length 2 Programming Instructions | 5-71 |
| Micro PDF417 | 5-72 |
| Disable/Enable Micro PDF417 | 5-72 |
| Micro PDF 128 Emulation | 5-73 |
| Micro PDF417 Minimum Reads | 5-74 |
| Length Control | 5-75 |
| Micro PDF417 Length 1, Length 2 Programming Instructions | 5-76 |
| Optical and Read Performance Parameters | A-1 |
| Scanner Dimensions | A-1 |
| Physical Properties | A-2 |
| Electrical Parameters | A-2 |
| Environmental Parameters | A-2 |
| Other Parameters | A-2 |
| Standard Cable Pinouts (Primary Interface Cables) | B-1 |
| RS-232 | B-1 |
| IBM Port 5B/9B/17 | B-1 |
| IBM USB | B-2 |
| USB & USB Keyboard | B-2 |
| Wand Emulation | B-2 |

| | |
|--------------------------------------|-----|
| Keyboard Wedge | B-2 |
| Standard Feature Defaults | D-1 |
| Keyboard Model Cross Reference | E-1 |
| Accepting RS-232 Commands | F-1 |

Chapter 1

Getting Started

The Magellan® 1400i Omni-Directional Imaging Scanner offers hands-free scanning for small, easily handled items and handheld scanning for bulkier items. Its aggressive imaging performance and intuitive operation reduces user training and speeds checkout for better customer service.

About This Manual

This manual presents advanced user information which includes connection, programming, product and cable specifications, and other useful references. For additional information, such as installation, maintenance, troubleshooting and warranty information, see the Quick Reference Guide (QRG). Copies of other publications for this product are downloadable free of charge from the website listed on the back cover of this manual.

On leaving the factory, units are programmed for the most common terminal and communications settings. If you need to change these settings, custom programming can be accomplished by scanning the bar codes in this guide.

Bold text and a yellow-highlighted background indicates the most common default setting for a feature/option.

Manual Conventions

The symbols listed below are used in this manual to notify the reader of key issues or procedures that must be observed when using the scanner:



NOTE

Notes contain information necessary for properly diagnosing, repairing and operating the scanner.



CAUTION

The CAUTION symbol advises you of actions that could damage equipment or property.

Connecting the Scanner

The scanner kit you ordered to match your interface should provide a compatible cable for your installation. Use the appropriate instructions below to connect the scanner to the terminal, PC or other host device.

Upon completing the connection via the appropriate interface instructions below, proceed to the [Interface Related Features](#) section of this manual and scan the bar code to select the correct interface type.

RS-232 Serial Connection — Turn off power to the terminal/PC and connect the scanner to the terminal/PC serial port via the RS-232 cable as shown in [Figure 1](#). If the terminal will not support POT (Power Off the Terminal) to supply scanner power, use the approved power supply (AC Adapter). Plug the AC Adapter barrel connector into the socket on the RS-232 cable connector and the AC Adapter plug into a standard power outlet.

Figure 1. RS-232 Serial or USB Connection using A/C Adapter

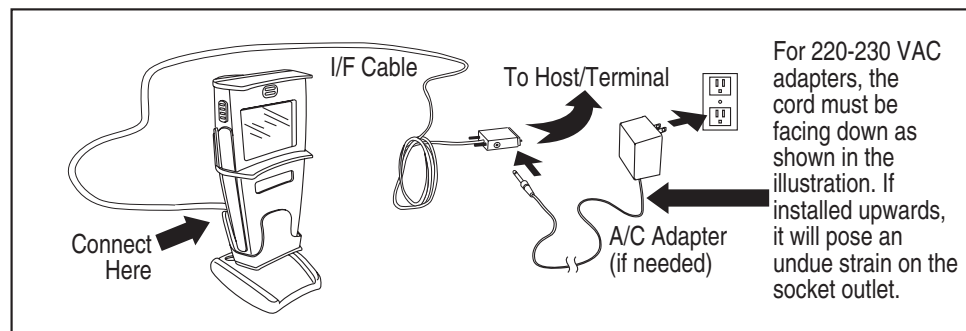

USB Connection — Connect the scanner to a USB port on the terminal/PC using the correct USB cable for the interface type you ordered. Reference [Figure 1](#) and [Figure 2](#).



NOTE

USB installations may require a power connection via an approved A/C Adapter as shown in [Figure 1](#). For example, this would be the case if the scanner is connected along with a number of other devices to a non-powered USB hub.

Figure 2. Other Connection Types

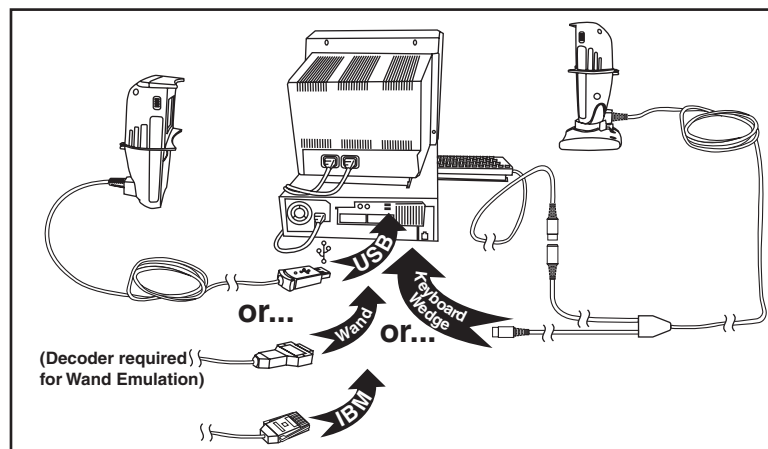

Wand Emulation Connection — Connect the scanner to the appropriate port on the terminal/PC via a decoder¹ using the correct cable for the interface type you ordered. Reference [Figure 2](#).

IBM Connection — Connect the scanner to the IBM port on the terminal/PC using the correct IBM cable. Reference [Figure 2](#).

Keyboard Wedge Connection — Before connection, turn off power to the terminal/PC. The Keyboard Wedge cable has a 'Y' connection from the scanner. Connect the female to the male end from the keyboard and the remaining end at the keyboard port at the terminal/PC. Reference [Figure 2](#).

Programming

The scanner is typically factory-configured with a set of default features standard to the interface type you ordered. After scanning the interface bar code from the [Interface Related Features](#) section, you can select other options and customize your scanner through use of the instructions and programming bar codes available in that section and also the [Data Editing](#) and [Symbologies](#) chapters of this manual.

Using the Programming Bar Codes

This manual contains feature descriptions and bar codes which allow you to reconfigure your scanner. Some programming bar code labels, like the label below for resetting defaults, require only the scan of that single label to enact the change. Most of the programming labels in this manual, however, require the scanner to be placed in Programming Mode prior to scanning them. Scan a START/END bar code once to enter Programming Mode. Once the scanner is in Programming Mode, you can scan a number of parameter settings before scanning the START/END bar code a second time, which will then accept your changes, exit Programming Mode and return the scanner to normal operation.

Resetting the Standard Product Defaults

If you are unsure of what programming options are in your scanner, or you've changed some options and want the factory settings restored, scan the *Standard Product Default Settings* bar code below (you do not have to scan START/END bar codes when scanning the Standard Product Default Settings bar code). This will copy the factory configuration for the currently active interface to the current configuration.



Standard Product Default Settings

The programming section lists the factory default settings for each of the menu commands for the standard RS-232 interface in **BOLD** text on the following pages. Exceptions to default settings for the other interfaces can be found in [Appendix D, Default Settings](#).

1. Wand Emulation requires a decoder.

LED and Beeper Indicators

The scanner's beeper sounds and its green LED illuminates to indicate various functions or errors on the scanner. The tables below list these indications. One exception to the behaviors listed in the tables is that the scanner's functions are programmable, and may or may not be turned on. For example, certain indications, such as the power-up beep can be disabled using programming bar code labels.

Green LED Indications

| LED INDICATION | INDICATION | COMMENT |
|----------------------|---|--|
| Power-on indication | Bright green flash | Indicates the scanner has finished all its power up tests and is now ready for operation. |
| Good Read Indication | Bright green flash | Indicates a bar code has been read and decoded. |
| Scanner Ready | Constant dim green | The scanner is ready for operation. |
| Sleep Mode | Constant green flash (100mS on, 1900mS off) | The scanner is in Sleep Mode. To wake the scanner up, move an object in front of its window or press the button atop the unit. |
| Host Disable | Constant green flash at 1 Hz (100mS on, 900mS off) | The scanner is disabled due to receiving a disable command from the POS terminal. |
| Diagnostics | Varies (see "Error Codes" on page 1-5 for more information) | The LED can provide diagnostic feedback if the scanner discovers a problem during SelfTest. |

BEEPER FUNCTIONS

| BEEPER INDICATION | INDICATION | COMMENT |
|------------------------------|---|---|
| Power On Beep | Single beep | The Power-On LED indication is a configurable feature which can be enabled or disabled. When enabled, this beep indicates the scanner has finished all its power up tests and is now ready for operation. |
| Good Read Indication | Single beep | The good read beep indication is configurable. Options include: Enable/disable, frequency, duration and volume. See the Product Reference Guide (PRG) for more information. |
| Diagnostics | Varies (see "Error Codes" on page 1-5 for more information) | The Beeper can provide diagnostic feedback if the scanner discovers a problem during SelfTest. |
| Programming Mode Indications | Varies (see the Product Reference Guide for more information about scanner programming) | The Beeper will sound as programming bar code labels are scanned, indicating progress during scanner configuration. |

Error Codes

Upon startup, if the scanner flashes its indicator LED or sounds an unexpected series of beep tones (other than normal power-up indications), this means the scanner has not passed its automatic Selftest and has entered FRU¹ isolation mode. If the scanner is reset or the button is pressed, the sequence will be repeated. The following table describes the LED flashes/beep codes associated with an error found.

| NUMBER OF LED FLASHES/ BEEPS | ERROR | CORRECTIVE ACTION |
|------------------------------|--------------------------|---------------------------------|
| 1 | Configuration | Contact Helpdesk for assistance |
| 2 | Interface PCB | |
| 6 | Main PCB | |
| 10 | Button Error | |
| 11 | Near Field Imager Module | |
| 12 | Far Field Imager Module | |
| 13 | Software ID Failure | |
| 14 | CPLD/Code Mismatch | |

1. Field Replaceable Unit (FRU)

NOTES

Chapter 2





General Features

Double Read Timeout

The Double Read Timeout feature sets a time limit that determines how much time must pass before reading the same label again (e.g. two identical items in succession).

|  | START / END |
|---|--|
| PROGRAMMING BAR CODES | |
| 0.1 Second |  |
|  | 0.2 Second |
| 0.3 Second |  |
|  | 0.4 Second |
| 0.5 Second |  |
|  | 0.6 Second DEFAULT |

Double Read Timeout – cont.

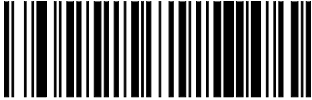
|  | START / END |
|---|--|
| PROGRAMMING BAR CODES | |
| 0.7 Second |  |
|  | 0.8 Second |
| 0.9 Second |  |
|  | 1 Second |



PDF Double Read Timeout







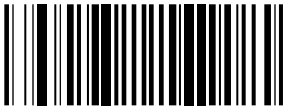

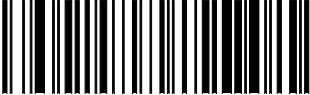
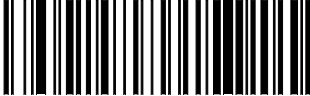

This double read timer value is used **ONLY** when scanning PDF417 bar codes.

NOTE

The PDF Double Read Timeout feature sets a time limit that determines how much time must pass before reading the same PDF417 label again (e.g. two identical PDF417 bar codes in succession).

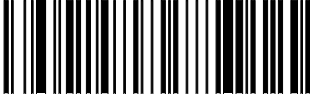

|  | START / END |
|---|--|
| PROGRAMMING BAR CODES | |
| 1.5 Seconds |  |

PDF Double Read Timeout – cont.

|  | START / END |
|---|--|
| PROGRAMMING BAR CODES | |
|  | 1.6 Seconds |
| <p style="text-align: center;">1.8 Seconds DEFAULT</p> |  |
|  | 1.9 Seconds |
| <p style="text-align: center;">2 Seconds</p> |  |
|  | 2.1 Seconds |
| <p style="text-align: center;">2.2 Seconds</p> |  |
|  | 2.3 Seconds |
| <p style="text-align: center;">2.4 Seconds</p> |  |
|  | 2.55 Seconds |



Label Gone Timeout

This feature sets the time after the last label segment is seen before the scanner prepares for a new label.

| | |
|---|--|
| START / END |  |
| PROGRAMMING BAR CODES | |
| <p>Sets the label gone timeout duration using hex values from 000 to 255 in increments of ten milliseconds (10ms or 0.01 seconds). To configure this feature, scan the “START/END” bar code above to place the unit in Programming Mode, then the “Set Label Gone Timeout,” followed by three digits (zero padded) from the Alphanumeric table in Appendix C, Alpha-Numeric Pad representing the desired time value. Exit programming mode by scanning the “START/END” bar code again.</p> <p style="text-align: center;">DEFAULT SETTING FOR THIS FEATURE: 200 milliseconds (020)</p> | |
|  | Set Label Gone Timeout |

PDF Label Gone Timeout

This setting specifies how long the [Label Gone Timeout](#) timer runs when specifically collecting PDF label segments prior to discarding data.





| | |
|--|--|
| START / END |  |
| PROGRAMMING BAR CODES | |
| <p>Sets the label gone timeout duration using hex values from 001 to 255 in increments of ten milliseconds (10ms or 0.01 seconds). To configure this feature, scan the “START/END” bar code above to place the unit in Programming Mode, then the “Set PDF Label Gone Timeout,” followed by three digits (zero padded) from the Alphanumeric table in Appendix C, Alpha-Numeric Pad representing the desired time value. Exit programming mode by scanning the “START/END” bar code again.</p> <p style="text-align: center;">DEFAULT SETTING FOR THIS FEATURE: 1.5 Seconds (150)</p> | |
|  | Set PDF Label Gone Timeout |

Sleep Mode

This feature specifies the amount of time with no bar code reads before the scanner enters sleep mode.

| | |
|---|--|
|  | START / END |
| PROGRAMMING BAR CODES | |
| 15 Seconds DEFAULT |  |
|  | 30 Seconds |
| 1 Minute |  |
|  | 2 Minutes |
| 3 Minutes |  |
|  | 4 Minutes |
| 5 Minutes |  |



Sleep Mode – cont.

| START / END |  |
|---|--|
| PROGRAMMING BAR CODES | |
|  | 6 Minutes |
| 7 Minutes |  |
|  | 8 Minutes |
| 9 Minutes |  |
|  | 10 Minutes DEFAULT |
| 12 Minutes |  |
|  | 15 Minutes |
| 30 Minutes |  |
|  | 1 Hour |

LED and Beeper Indicators

Power On Alert

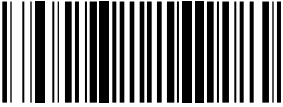
Disables or enables the indication (a single beep) that the scanner has finished all its power up tests and is now ready for operation.

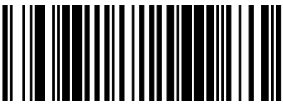
| | |
|---|---|
|  | START / END |
| PROGRAMMING BAR CODES | |
| Disable |  |
|  | Enable DEFAULT |

Good Read: When to Indicate





This feature specifies when the scanner will provide indication (beep and/or flash its green LED) upon successfully reading a bar code. Choices are:

- Good Read = Indicate after decode
- Good Read = Indicate after transmit
- Good Read = Indicate after CTS goes inactive, then active





This option (Indicate after CTS goes inactive, then active), which uses CTS, is only valid for RS-232 interfaces.

NOTE

| | |
|--|--|
|  | START / END |
| PROGRAMMING BAR CODES | |
| After Decode DEFAULT |  |
|  | After Transmit |
| After CTS goes inactive, then active |  |





Good Read Beep Control

This feature enables/disables the scanner's ability to beep upon a successful decode of a bar code.

| | |
|---|---|
|  | START / END |
| PROGRAMMING BAR CODES | |
| Disable |  |
|  | Enable DEFAULT |

Good Read Beep Frequency

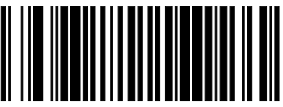
Adjusts the good read beep to sound at a selectable low, medium or high frequency, selectable from the list below. (Controls the beeper's pitch/tone.)

| | |
|---|---|
|  | START / END |
| PROGRAMMING BAR CODES | |
| Low |  |
|  | Medium DEFAULT |
| High |  |



Good Read Beep Length

Specifies the duration of a good read beep.

|  | START / END |
|---|--|
| PROGRAMMING BAR CODES | |
| 60msec DEFAULT |  |
|  | 80msec |
| 100msec |  |
|  | 120msec |
| 140msec |  |
|  | 160msec |
| 180msec |  |
|  | 200msec |

Good Read Beep Volume

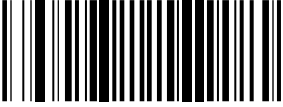
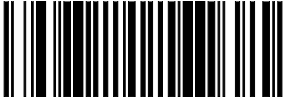
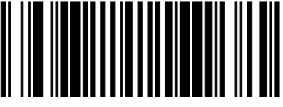
Selects the beeper volume (loudness) upon a good read beep. There are three selectable volume levels.

| | |
|---|---|
|  | START / END |
| PROGRAMMING BAR CODES | |
| Low |  |
|  | Medium |
| High DEFAULT |  |



Productivity Index Reporting (PIR)

When PIR is enabled, label quality data is appended to decoded data before being presented to the POS. The PIR feature allows the scanner to provide information to an external computer, indicating how easy the label was to read.



NOTE

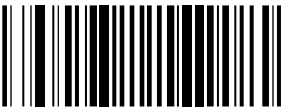

This value-added feature is a factory-programmed option. Contact your dealer for information about upgrading your system to include this advanced capability.

| | |
|---|--|
|  | START / END |
| PROGRAMMING BARCODES | |
| Disable DEFAULT |  |
|  | Enable |

Scanning Features

Aiming Pointer

This feature enables/disables the Aiming Pointer for all symbologies.

| | |
|---|--|
| START / END |  |
| PROGRAMMING BAR CODES | |
|  | Disable DEFAULT |
| Enable always on |  |

Targeted Scanning Mode

Upon pressing the button, the scanner will project an aiming pattern to assist in centering over the bar code. Scanning then takes place as soon as the button is released.



When add-ons are enabled and a bar code is being read while in Targeted Mode, position the pointer at or near the end of the base label to ensure the scanner will read both the base and add-on label.

NOTE

Targeted Scanning Mode will read bar codes in any orientation.

The scanner will return to full pattern Omni-directional Mode after either of the following has occurred:





- Good Read + Target Mode: Linger Time has elapsed.
- Target Mode: Active Time + Target Mode: Linger Time has elapsed.

Configuration options for Targeted Scanning Mode are:

- Target Mode: Active Time
- Target Mode: Linger Time

Target Mode: Active Time

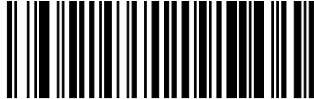
Specifies the time duration the scanner attempts to decode labels while in the targeted mode of operation.

| | |
|--|--|
|  | START / END |
| PROGRAMMING BAR CODES | |
| Extra Short Duration |  |
|  | Short Duration |
| Medium Duration DEFAULT |  |
|  | Long Duration |

Target Mode: Linger Time

Specifies the time duration the scanner remains in the targeted mode of operation after reading a bar code or after **Target Mode: Active Time** has expired, before reverting to Omni-directional Mode. The linger timer starts upon a good read or upon timeout of **Target Mode: Active Time**; whichever is earliest. A button press at any time will reset the process back to the start.



NOTE









Active Time and Linger Time settings are totally independent from one another.

During the period Linger Time is active, no bar codes can be read, no matter what mode the scanner is in.







| | |
|---|--|
| START / END |  |
| PROGRAMMING BAR CODES | |
|  | Short Duration |
| Medium Duration DEFAULT |  |
|  | Long Duration |

Wake Up Intensity

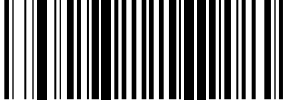
This feature indicates the percentage of ambient light change which will trigger the scanner to wake up from Sleep Mode. Lower settings provide greater sensitivity.

|  | START / END |
|---|--|
| PROGRAMMING BAR CODES | |
| 5% |  |
|  | 8% |
| 10% DEFAULT |  |
|  | 15% |
| 20% |  |
|  | 25% |
| 30% |  |
|  | 35% |

Wake Up Intensity – cont.

|  | START / END |
|---|---|
| PROGRAMMING BAR CODES | |
| 40% |  |
|  | 50% |
| 60% |  |
|  | 70% |
| 80% |  |

Chapter 3

Interface Related Features

At the time of this writing, the Scanner supports the interfaces listed in [Table 3-1](#). Select the desired interface type from the table, then reference the page number given for the customizable features section associated with each interface. See [Table 3-2](#) for a description of each Keyboard Wedge interface type (A through Y as listed).

Table 3-1. Interfaces Supported

| RS-232 | Page | Keyboard Wedge | Page |
|--|------|--|------|
| RS-232 Standard | 3-9 | Keyboard Wedge H^a | |
| RS-232 Wincor-Nixdorf | 3-9 | Keyboard Wedge I^a | 3-30 |
| IBM | | Keyboard Wedge J^a | 3-30 |
| IBM 4683 Port 5B | 3-24 | Keyboard Wedge K^a | 3-30 |
| IBM 4683 Port 9B | 3-24 | Keyboard Wedge L^a | 3-30 |
| IBM 4683 Port 17 | 3-24 | Keyboard Wedge M^a | 3-30 |
| USB | | Keyboard Wedge N^a | 3-30 |
| IBM USB | 3-24 | Keyboard Wedge N^a | 3-30 |
| USB Keyboard | 3-24 | Keyboard Wedge O^a | 3-30 |
| Wand Emulation | | Keyboard Wedge P^a | 3-30 |
| Wand Emulation | 3-26 | Keyboard Wedge Q^a | 3-30 |
| Keyboard Wedge | 3-30 | Keyboard Wedge R^a | 3-30 |
| Keyboard Wedge A^a | 3-30 | Keyboard Wedge S^a | 3-30 |
| Keyboard Wedge B^a | 3-30 | Keyboard Wedge T^a | 3-30 |
| Keyboard Wedge C^a | 3-30 | Keyboard Wedge U^a | 3-30 |
| Keyboard Wedge D^a | 3-30 | Keyboard Wedge V^a | 3-30 |
| Keyboard Wedge E^a | 3-30 | Keyboard Wedge W^a | 3-30 |
| Keyboard Wedge F^a | 3-30 | Keyboard Wedge X^a | 3-30 |
| Keyboard Wedge G^a | 3-30 | Keyboard Wedge Y^a | 3-30 |

a. Consult [Table](#) for more information regarding keyboard interface types.



The correct interface cable is included for the scanner interface type you ordered.

NOTE

Table 3-2. Keyboard Wedge Interface Reference

| I/F Type | PCs Supported |
|----------|--|
| A | PC/XT w/Alternate Key Encoding |
| B | AT, PS/2 25-286, 30-286, 50, 50Z, 60, 70, 80, 90 & 95 w/Alternate Key Encoding |
| C | PS/2 25 and 30 w/Alternate Key Encoding |
| D | PC/XT w/Standard Key Encoding |
| E | AT, PS/2 25-286, 30-286, 50, 50Z, 60, 70, 80, 90 & 95 w/Standard Key Encoding |
| F | PS/2 25 and 30 w/Standard Key Encoding |
| G | IBM 3xxx w/122 keyboard |
| H | IBM 3xxx w/102 keyboard |
| I | PS/55 5530T w/104 keyboard |
| J | NEC 9801 |
| K | WYSE 30/30+ WY-30 Keyboard 83 Keys |
| L | WYSE 60/85/99 GT/150/160/285 Style IBM Enhanced PC, 520/520ES Style IBM Enhanced PC FR WYSE 55/65/65 ES/120/185/325 Style IBM Enhanced PC |
| M | WYSE 60/85/99 GT/150/160/285 ANSI Keyboard 105 Keys, 520/520 ES ANSI Keyboard 105 Keys WYSE 55/65/65 ES/120/185/325 ANSI Keyboard 105 Keys |
| N | WYSE 60/85/99 GT/150/160/285 ASCII Kbd, 520/520 ES ASCII Kbd WYSE 55/65/65 ES/120/185/325 ASCII Keyboard |
| O | WYSE 60/85/99 GT/150/160/285 ANSI W285 Keyboard 105 Keys, 520/520 ES ANSI W285 Keyboard 105 Keys WYSE 55/65/65 ES/120/185/325 ANSI W285 Keyboard 105 Keys |
| P | WYSE WINTERM 3320 SE |
| Q | IBM 3153 IBM 316X, 3179/3180/319X/3270 |
| R | IBM 3151/3152-010, 347X/348X |
| S | DIGITAL VT 220/320/330/340/350/382 |
| T | DIGITAL VT420 |
| U | DIGITAL VT 510/520 IBM ANSI Style Keyboard |
| V | DIGITAL VT 510/520 IBM PC Style Keyboard |
| W | SUN SPARC 5/10 |
| X | SUN 420/440, ITX |
| Y | WYSE 370/355 Style Enhanced IBM PC |

**NOTE**

Reference [Appendix E, Keyboard Function Key Mappings](#) for more information about keyboards.









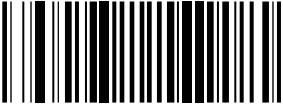

Interface Selection

| | |
|---|---|
| START / END |  |
| PROGRAMMING BAR CODES | |
|  | RS-232 Standard |
| RS-232 Wincor-Nixdorf |  |
|  | IBM 4683 Port 5B |
| IBM 4683 Port 9B |  |
|  | IBM 4683 Port 17 |
| IBM USB |  |
|  | USB Keyboard |
| Wand Emulation |  |
|  | Keyboard Wedge A |







Interface Selection — cont.

| | |
|---|--|
| START / END |  |
| PROGRAMMING BAR CODES | |
|  | Keyboard Wedge B |
| Keyboard Wedge C |  |
|  | Keyboard Wedge D |
| Keyboard Wedge E |  |
|  | Keyboard Wedge F |
| Keyboard Wedge G |  |
|  | Keyboard Wedge H |
| Keyboard Wedge I |  |
|  | Keyboard Wedge J |

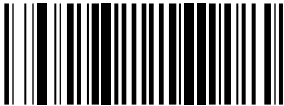
Interface Selection – cont.

| | |
|---|--|
|  | <p>START / END</p> |
| <p>PROGRAMMING BAR CODES</p> | |
| <p>Keyboard Wedge K</p> |  |
|  | <p>Keyboard Wedge L</p> |
| <p>Keyboard Wedge M</p> |  |
|  | <p>Keyboard Wedge N</p> |
| <p>Keyboard Wedge O</p> |  |
|  | <p>Keyboard Wedge P</p> |
| <p>Keyboard Wedge Q</p> |  |
|  | <p>Keyboard Wedge R</p> |
| <p>Keyboard Wedge S</p> |  |



Interface Selection — cont.

| | |
|---|---|
|  | START / END |
| PROGRAMMING BAR CODES | |
| Keyboard Wedge T |  |
|  | Keyboard Wedge U |
| Keyboard Wedge V |  |
|  | Keyboard Wedge W |
| Keyboard Wedge X |  |
|  | Keyboard Wedge Y |

Interface Features

Obey/Ignore Host Commands

When set to ignore host commands, the scanner will ignore all host commands except for the minimum set necessary to keep the interface active and transmit labels. For normal operation of the interface, select Obey Host Commands.



| | |
|---|---|
| START / END |  |
| PROGRAMMING BAR CODES | |
|  | Obey Host Commands DEFAULT |
| Ignore Host Commands |  |

Interface Features – cont.

Host Transmission Buffers

Specifies the number of host transmission(s) that may be buffered. By buffering data from a bar code, the scanner can continue to read a new bar code while the old one is being transmitted to the host. Selecting BUFFERS = 1 means that the first bar code must be transmitted before a new one can be read. A selection of BUFFERS = 2 means that a new bar code can be read while data from the first bar code is transmitted.









When a DISABLE SCANNER command is received from the host, the scanner will continue to transmit all data that is buffered.

| | |
|---|---|
| START / END |  |
| PROGRAMMING BAR CODES | |
|  | Host Transmission Buffers = 1 |
| Host Transmission Buffers = 2 DEFAULT |  |

RS-232 Interface Features

| | |
|---|--|
| START / END |  |
| PROGRAMMING BAR CODES | |
|  | 1200 Baud |
| 2400 Baud |  |
|  | 4800 Baud |
| 9600 Baud DEFAULT |  |
|  | 19200 Baud |
| 38400 Baud |  |
|  | 57600 Baud |
| 115200 Baud |  |

RS-232 Interface Features – cont.

| | |
|---|--|
| START / END |  |
| PROGRAMMING BAR CODES | |
|  | 7 Data Bits |
| 8 Data Bits DEFAULT |  |
|  | 1 Stop Bit DEFAULT |
| 2 Stop Bits |  |
|  | Parity = None DEFAULT |
| Parity = Even |  |
|  | Parity = Odd |





RS-232 Interface Features – cont.

Hardware Flow Control

Disable Hardware Control— The scanner transmits to the host regardless of any activity on the CTS line.

Enable CTS Flow Control— The CTS signal controls transmission of data to the host.

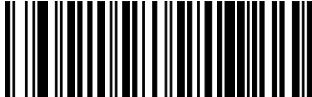
Enable CTS Scan Control— The CTS line must be active for the scanner to read and transmit data. While the CTS line is inactive, the scanner remains in a host-disabled state; following a successful label transmission, the CTS signal must transition to inactive and then to active to enable scanning for the next label.

| | |
|---|--|
| START / END |  |
| PROGRAMMING BAR CODES | |
|  | Disable Hardware Control DEFAULT |
| Enable CTS Flow Control |  |
|  | Enable CTS Scan Control |



RS-232 Interface Features – cont.

Intercharacter Delay

This delay is inserted after each data character transmitted. If the transmission speed is too high, the system may not be able to receive all characters. You may need to adjust the delay to make the system work properly.



| START / END |  |
|---|--|
| PROGRAMMING BAR CODES | |
|  | Inter-Char Delay = No Delay DEFAULT |
| Interchar Delay = 10 msec |  |
|  | Interchar Delay = 20 msec |
| Interchar Delay = 30 msec |  |
|  | Interchar Delay = 40 msec |
| Interchar Delay = 50 msec |  |
|  | Interchar Delay = 60 msec |
| Interchar Delay = 70 msec |  |

Intercharacter Delay – cont.

| | |
|---|---|
| START / END |  |
| PROGRAMMING BAR CODES | |
|  | Interchar Delay = 80 msec |
| Interchar Delay = 90 msec |  |

Software Flow Control



Disables/Enables software control using XON/XOFF characters.

| | |
|--|---|
| START / END |  |
| PROGRAMMING BAR CODES | |
|  | Disable Software Flow Control DEFAULT |
| Enable Software Flow Control |  |

RS-232 Interface Features – cont.

Host Echo

When enabled, this feature passes all data through the scanner to the host as it comes in. This feature is used for applications where “daisy chaining” of RS-232 devices onto the same cable is necessary. If, for example, one of the devices in the chain is a terminal where someone is entering data while another person is simultaneously scanning a bar code requiring transmission to the host, the scanner will wait for the RS-232 channel to be quiet for a specified period of time (set via *RS-232 Host Echo Quiet Interval*). The scanner can be set to observe this delay before sending its data in order to avoid RS-232 transmission conflicts.

| | |
|---|---|
| START / END |  |
| PROGRAMMING BAR CODES | |
|  | Disable Host Echo DEFAULT |
| Enable Host Echo |  |





RS-232 Interface Features – cont.

Host Echo Quiet Interval

This setting specifies the time interval of RS-232 channel inactivity which must transpire before the scanner will break the host echo loop to transmit the bar code data that has just been scanned to the host.



| START / END |  |
|---|--|
| PROGRAMMING BAR CODES | |
|  | Host Echo Quiet Interval = 0msec |
| <p data-bbox="331 730 691 789">Host Echo Quiet Interval = 10msec DEFAULT</p> |  |
|  | Host Echo Quiet Interval = 20msec |
| <p data-bbox="342 1033 683 1058">Host Echo Quiet Interval = 30msec</p> |  |
|  | Host Echo Quiet Interval = 40msec |
| <p data-bbox="342 1325 683 1350">Host Echo Quiet Interval = 50msec</p> |  |
|  | Host Echo Quiet Interval = 60msec |
| <p data-bbox="342 1612 683 1638">Host Echo Quiet Interval = 70msec</p> |  |

Host Echo Quiet Interval – cont.

| | |
|---|--|
| START / END |  |
| PROGRAMMING BAR CODES | |
|  | Host Echo Quiet Interval = 80msec |
| Host Echo Quiet Interval = 90msec |  |
|  | Host Echo Quiet Interval = 100msec |

Signal Voltage: Normal/TTL



Specifies whether the RS-232 interface provides TTL levels on the output pins TxD and RTS.

| | |
|---|--|
| START / END |  |
| PROGRAMMING BAR CODES | |
|  | Signal Voltage: Normal RS-232 DEFAULT |
| Signal Voltage: TTL |  |

RS-232 Interface Features – cont.



RS-232 Invert

Enables/disables inversion of RS-232 TXD and RXD signals.

| | |
|---|---|
| START / END |  |
| PROGRAMMING BAR CODES | |
|  | Disable RS-232 Invert DEFAULT |
| Enable RS-232 Invert |  |

Beep on ASCII BEL



Enables/disables ability of scanner to beep (sound a good read tone) on receiving an ASCII BEL (07 hex).

| | |
|---|---|
| START / END |  |
| PROGRAMMING BAR CODES | |
|  | Enable Beep on ASCII BEL DEFAULT |
| Disable Beep on ASCII BEL |  |

RS-232 Interface Features – cont.

Beep on Not on File

Select for the host to beep (or not) when a not-on-file (host command) condition is detected by the host.





| | |
|---|--|
| START / END |  |
| PROGRAMMING BAR CODES | |
|  | Disable Beep on Not On File |
| Enable Beep on Not On File DEFAULT |  |

RS-232 Interface Features – cont.

ACK NAK Options

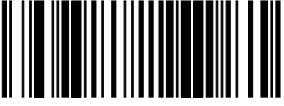

This enables/disables the ability of the scanner to support the RS-232 ACK/NAK protocol. When configured, the scanner and/or host sends an “ACK” when it receives data properly, and sends “NAK” when the data is in error. Selections for this option are:

- Disable
- Enable for label transmission — the scanner expects an ACK/NAK response from the host when a label is sent
- Enable for host-command acknowledge — the scanner will respond with ACK/NAK when the host sends a command
- Enable for label transmission and host-command acknowledge



| | |
|---|---|
| START / END |  |
| PROGRAMMING BAR CODES | |
|  | Disable ACK NAK DEFAULT |
| Enable ACK NAK for Transmission |  |
|  | Enable ACK NAK for host command acknowledge |
| Enable ACK NAK for transmission and host command |  |

RS-232 Interface Features – cont.

ACK Character

| | |
|--|--|
| START / END |  |
| PROGRAMMING BAR CODES | |
| <p>Sets the ACK character from the set of ASCII characters or any decimal value from 000 to 255. Pad entries of less than three digits with zeros, as in "005". To configure this feature, scan the "START/END" bar code above to place the unit in Programming Mode, then the "Set ACK Character," followed by the digits from the Alphanumeric table in Appendix C, Alpha-Numeric Pad representing your desired character. Exit programming mode by again scanning the "START/END" bar code above.</p> <p style="text-align: center;">DEFAULT SETTING FOR THIS FEATURE: 006 (ACK)</p> | |
|  | Set ACK Character |



NAK Character

| | |
|--|--|
| START / END |  |
| PROGRAMMING BAR CODES | |
| <p>Sets the NAK character from the set of ASCII characters or any decimal value from 000 to 255. Pad entries of less than three digits with zeros, as in "005". To configure this feature, scan the "START/END" bar code above to place the unit in Programming Mode, then the "Set NAK Character," followed by the digits from the Alphanumeric table in Appendix C, Alpha-Numeric Pad representing your desired character. Exit programming mode by again scanning the "START/END" bar code above.</p> <p style="text-align: center;">DEFAULT SETTING FOR THIS FEATURE: 021 (!)</p> | |
|  | Set NAK Character |

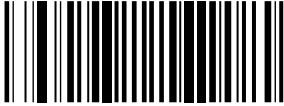

RS-232 Interface Features – cont.

Retry on ACK NAK Timeout

Enables/disables retry after the configurable ACK NAK Timeout Value (set in the following feature) has expired.

| | |
|---|---|
| START / END |  |
| PROGRAMMING BAR CODES | |
|  | Disable Retry on ACK NAK Timeout |
| Enable Retry on ACK NAK Timeout DEFAULT |  |

ACK NAK Timeout Value

| | |
|--|---|
| START / END |  |
| PROGRAMMING BAR CODES | |
| <p>This item specifies the time the scanner will wait for an ACK character from the host following a label transmission. 000 = Infinite timeout 001 - 075 = Timeout in 200-millisecond increments To configure this feature, scan the "START/END" bar code above to place the unit in Programming Mode, then the "Set ACK NAK Timeout Value," followed by the two digits (zero padded) from the Alphanumeric table in Appendix C, Alpha-Numeric Pad representing your desired value. Exit programming mode by again scanning the "START/END" bar code above. DEFAULT SETTING FOR THIS FEATURE: 001 (200 msec)</p> | |
|  | Set ACK NAK Timeout Value |

RS-232 Interface Features – cont.

ACK NAK Retry Count

START / END



PROGRAMMING BAR CODES

This feature sets the number of times for the scanner to retry a label transmission under a retry condition.

000 = No retry

001 - 254 = Retry for the specified number of times

255 = Retry forever

To configure this feature, scan the “START/END” bar code above to place the unit in Programming Mode, then the “Set ACK NAK Retry Count,” followed by the three digits (zero padded) from the Alphanumeric table in [Appendix C, Alpha-Numeric Pad](#) representing your desired retry count. Exit programming mode by again scanning the “START/END” bar code above

DEFAULT SETTING FOR THIS FEATURE: 003



Set ACK NAK Timeout Value

RS-232 Interface Features – cont.





ACK NAK Error Handling

This item specifies the method the scanner will use to handle errors detected while waiting to receive the ACK character from the host. Errors include unrecognized host commands and communication errors such as parity or framing errors. Choices are:

00 = Ignore errors detected (recommended setting)

01 = Process error as valid ACK character (risk of lost label data)



02 = Process error as valid NAK character (risk of duplicate label data)

| | |
|---|--|
| START / END |  |
| PROGRAMMING BAR CODES | |
|  | Ignore Errors Detected DEFAULT |
| Process error as valid ACK character |  |
|  | Process error as valid NAK character |

RS-232 Interface Features – cont.

Transmission Failure Indication

Enables/disables bad-label indication upon transmission failure.

| | |
|---|--|
| START / END |  |
| PROGRAMMING BAR CODES | |
|  | Disable Transmission Error Indication |
| Enable Transmission Error Indication DEFAULT |  |



IBM-USB Interface Features

IBM-USB Device usage

The IBM-USB protocol allows for the scanner to be identified as one of two different types of bar code scanners. Depending on what other scanners you may already have connected to a IBM-USB POS, you may need to change this setting to enable all devices to communicate.

Options are:



- Table Top Scanner
- Handheld Scanner

| | |
|---|--|
| START / END |  |
| PROGRAMMING BAR CODES | |
|  | Configure as Table Top Scanner |
| Configure as Handheld Scanner DEFAULT |  |

IBM

IBM Transmit Labels in Code 39 Format

This feature enables/disables scanner's ability to set a symbology identifier for a specified label to Code 39 before transmitting that label data to an IBM host. This applies to: Code 128, Codabar and Code 93 for IBM USB; Code 128, Codabar and Code 93 for IBM Port 5B; and Codabar and Code 93 for IBM Port 9B.

| | |
|---|---|
| START / END |  |
| PROGRAMMING BAR CODES | |
|  | Disable Convert to Code 39 DEFAULT |
| Enable Convert to Code 39 |  |

Wand Emulation

Supported Symbologies

The Wand Emulation interface will transmit bar code data as a wand device would. This interface will transmit the following bar code symbologies:

- UPC/EAN
- UPC/EAN with add-ons
- Code 39
- Full ASCII Code 39
- Interleaved 2 of 5
- Codabar
- Code 128

Pharmacode 39 is transmitted as Code 39. All other bar code symbology types read by the scanner will be transmitted as Code 128.

Wand Emulation Bar Code Format

The following format settings are required for the wand emulation interface. These settings have been pre-configured at the factory for Wand Emulation scanners.



- UPC-A bar codes must include all 12 digits.
- UPC-E bar codes must contain 8 digits, including a system digit, 6 data digits, and the check digit.
- EAN-13 bar codes must have all 13 digits.
- EAN-8 bar codes must include all 8 digits.
- Code 39, Code 39 Full ASCII, and Pharmacode 39 bar codes must NOT contain start / stop characters.
- Codabar bar codes must include the start / stop characters, presented in the ABCD format.
- Interleaved 2 of 5 bar codes must have an even number of digits.

Wand Emulation – cont.

Bar/Space Polarity

Low/High — Black will be transmitted as a low voltage level (0 to +0.7V) and space as high level (+2.4 to +5.25V).

High/Low — Black will be transmitted as a high voltage level (+2.4 to +5.25V) and space as low level (0 to +0.7V).



| | |
|---|---|
| START / END |  |
| PROGRAMMING BAR CODES | |
|  | Bar/Space = Low/High |
| Bar/Space = High/Low DEFAULT |  |

Wand Idle State

This feature specifies the level of the wand output signal when idle. TTL logic levels:

High voltage level (+2.4 to +5.25V)

Low voltage level (0 to +0.7V).

| | |
|---|---|
| START / END |  |
| PROGRAMMING BAR CODES | |
|  | Wand Idle State = Low DEFAULT |
| Wand Idle State = High |  |



Wand Emulation – cont.

Signal Speed

The speed of the transmission can be set. This selects the width of the minimum narrow bar.



330 microseconds

660 microseconds

| START / END | |
|---|--|
| PROGRAMMING BAR CODES | |
|  | Signal Speed = 330mS |
| Signal Speed = 660mS DEFAULT |  |

Transmit Trailing Noise



The transmission of noise pulses after the label may be enabled or disabled.

| START / END | |
|---|--|
| PROGRAMMING BAR CODES | |
|  | Disable Trailing Noise |
| Enable Trailing Noise DEFAULT |  |

Wand Emulation – cont.

Transmit Leading Noise





The transmission of noise pulses before the bar code may be enabled or disabled.

| | |
|---|---|
| START / END |  |
| PROGRAMMING BAR CODES | |
|  | Disable Leading Noise |
| Enable Leading Noise DEFAULT |  |

Symbology Conversion

Wand Emulation can convert all bar codes to a single symbology. Choices are:

- No Conversion
- Convert to Code 39
- Convert to Code 128

| | |
|---|---|
| START / END |  |
| PROGRAMMING BAR CODES | |
|  | No Symbology Conversion DEFAULT |
| Convert to C39 |  |
|  | Convert to C128 |

Keyboard Wedge

and

USB Keyboard

As a keyboard interface, the scanner supports most popular PCs and IBM terminals. The installation of the wedge is a fairly simple process that doesn't require any changes of software or hardware.



NOTE

All of the options in this section apply to the Keyboard Wedge, however, only some apply to USB Keyboard.

Keyboard Layout

The Keyboard Layout option supports many countries. For details about Keyboard Layout, please refer to your operating system manual.

| START / END |  |
|---|--|
| PROGRAMMING BAR CODES | |
|  | USA DEFAULT |
| Belgium |  |
|  | Britain |
| Denmark |  |
|  | France |
| Germany |  |

Keyboard Wedge – cont.





| | |
|---|---|
| START / END |  |
| PROGRAMMING BAR CODES | |
|  | Italy |
| Norway |  |
|  | Portugal |
| Spain |  |
|  | Sweden |
| Switzerland |  |
|  | Japan 106 Key |
| Hungary |  |
|  | Czech |

Keyboard Wedge – cont.

| | |
|---|--|
| START / END |  |
| PROGRAMMING BAR CODES | |
|  | Slovakia |
| Romania |  |
|  | Croatia |
| Poland |  |

Caps Lock State

Specifies the format in which the scanner sends character data.

| | |
|---|--|
| START / END |  |
| PROGRAMMING BAR CODES | |
|  | Disable Caps Lock DEFAULT |
| Caps Lock "ON" |  |
|  | Shift Lock "ON" |

Keyboard Wedge – cont.



Power-On Simulation



This feature does not apply to the USB Keyboard interface.

NOTE

All PCs check the keyboard status during the power-on Selftest. It is recommended that you enable this function if you are working without a keyboard installation. It simulates keyboard timing and passes the keyboard status to the PC during power-on.





| | |
|---|--|
| START / END |  |
| PROGRAMMING BAR CODES | |
|  | Disable Power-on Simulation DEFAULT |
| Enable Power-on Simulation |  |

Keyboard Wedge – cont.

Control Characters

Specifies how the scanner transmits ASCII control characters to the host. Choices are:

- Disable Control Characters
- Enable transmission of control characters to host
- Send characters between 00H and 1FH according to a special function-key mapping table. (This is used to send keys that are not in the normal ASCII set; a unique set is provided for each available scancode set. Reference [Appendix E, Keyboard Function Key Mappings.](#))

| | |
|---|---|
| START / END |  |
| PROGRAMMING BAR CODES | |
|  | Disable Control Characters DEFAULT |
| Enable Transmission of Control Characters |  |
|  | Enable Function Key Mapping |

Keyboard Wedge – cont.



Wedge Quiet Interval



NOTE

This feature does not apply to the USB Keyboard interface.

Quiet Interval is the amount of time to look for keyboard activity before the scanner breaks the keyboard connection in order to transmit data to the host.

| | |
|---|---|
| START / END |  |
| PROGRAMMING BAR CODES | |
| <p>Selectable from 000 (no interval) to 255 in 10 msec increments. To configure this feature, scan the “START/END” bar code above to place the unit in Programming Mode, then the Set Wedge Quiet Interval bar code followed by the three digits (zero padded) from the Alphanumeric table in Appendix C. Alpha-Numeric Pad representing your desired length. Exit programming mode by again scanning the “START/END” bar code above.</p> | |
| <p>DEFAULT SETTING FOR THIS FEATURE: 010 (100 msec)</p> | |
|  | Set Wedge Quiet Interval |

Keyboard Wedge – cont.

Intercharacter Delay



NOTE

This feature does not apply to the USB Keyboard interface.

START / END



PROGRAMMING BAR CODES

One-half of the delay specified below is inserted between scancodes within each character. If the transmission speed is too high, the system may not be able to receive all characters. You may need to adjust the delay to make the system work properly. Selectable from 000 to 255 in 10msec increments. To configure this feature, scan the “START/END” bar code above to place the unit in Programming Mode, then the “Set Intercharacter Delay,” followed by the three digits (zero padded) from the Alphanumeric table in [Appendix C, Alpha-Numeric Pad](#) representing your desired length. Exit programming mode by again scanning the “START/END” bar code above/

DEFAULT SETTING FOR THIS FEATURE:

000 (No Delay)



Set Intercharacter Delay

Chapter 4

Data Editing

Data Editing Overview



CAUTION

It is not recommended to use these features with IBM or Wand Emulation interfaces.

When a bar code is scanned, additional information can be sent to the host computer along with the bar code data. This combination of bar code data and supplementary user-defined data is called a “message string.” The features in this chapter can be used to build specific user-defined data into a message string.

There are several types of selectable data characters that can be sent before and after scanned data. You can specify if they should be sent with all symbologies, or only with specific symbologies. [Figure 4-1](#) shows the available elements you can add to a message string:

Figure 4-1. Breakdown of a Message String

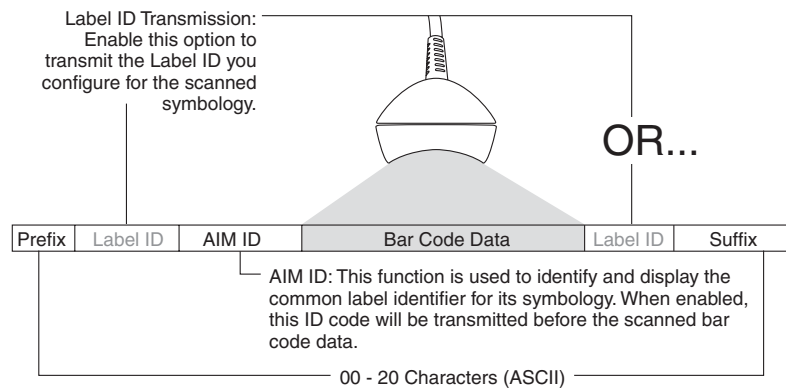

Please Keep In Mind...

- Modifying a message string is not a mandatory requirement. Data editing is sophisticated feature allowing highly customizable output for advanced users. Factory default settings for data editing is typically set to NONE.
- A prefix or suffix may be applied (reference the [Symbologies](#) chapter for these settings) across all symbologies (set via the Global features in this chapter).
- You can add any character from the [ASCII Chart](#) (from 00-FF) on the inside back cover of this manual as a prefix, suffix or Label ID.

- Enter prefixes and suffixes in the order in which you want them to appear on the output.

Global Prefix/Suffix

Up to 20 ASCII characters may be added as a prefix (in a position before the bar code data) and/or as a suffix (in a position following the bar code data) as indicated in [Figure 4-2](#).

Figure 4-2. Prefix and Suffix Positions

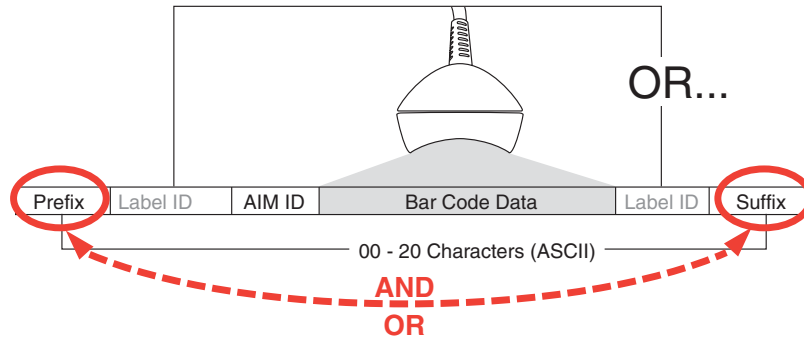

Example: Setting a Prefix

In this example, we'll set a prefix for all symbologies.

1. Determine which ASCII character(s) are to be added to scanned bar code data. In this example, we'll add a dollar sign ('\$') as a prefix.
2. Scan the START bar code.
3. Scan the SET PREFIX bar code.
4. Reference the [ASCII Chart](#) on the inside back cover of this manual, to find the hex value assigned to the desired character. The corresponding hex number for the '\$' character is 24. To enter this selection code, scan the '2' and '4' bar codes from [Appendix C, Alpha-Numeric Pad](#).
5. Scan the END bar code to exit Programming Mode.



If less than the expected string of 20 characters are selected, scan the END bar code twice to accept the selections and exit Programming Mode.



NOTE

6. The resulting message string would appear as follows:

Scanned bar code data:12345

Resulting message string output: \$12345

Global Prefix/Suffix – cont.

| | |
|--|---|
| START / END |  |
| PROGRAMMING BARCODES | |
| <p>Sets up to 20 characters each from the set of ASCII characters or any hex value from 0 to FF. To configure this feature, scan the “START/END” bar code above to place the unit in Programming Mode, then the “Set Prefix” or “Set Suffix,” followed by the digits from the Alphanumeric table in Appendix C, Alpha-Numeric Pad representing your desired character(s). Reference the section, "Example: Setting a Prefix", for more information. Exit programming mode by scanning the “START/END” barcode again (scan “START/END” twice if less than 20 characters have been selected).</p> <p style="text-align: center;">DEFAULT SETTING PREFIX: 00 (None) DEFAULT SETTING SUFFIX: 0D (CR)</p> | |
|  | Set Prefix |
| Set Suffix |  |

AIM ID

AIM (Automatic Identification Manufacturers) label identifiers are assigned from a globally standardized list — as opposed to custom label ID characters you select yourself — and can be included with scanned bar code data. AIM label identifiers consist of three characters as follows:



- A close brace character (ASCII ‘}’), followed by...
- A code character (see the table below), followed by...
- A modifier character (the modifier character is symbol dependent)

| SYMBOLGY | CHAR | SYMBOLGY | CHAR |
|--------------------|------|----------------------------|----------------|
| UPC/EAN | E | Code 128/EAN 128 | C |
| Code 39 | A | MSI/Plessey | M |
| Codabar | F | RSS (RSS-14, RSS Expanded) | e |
| Interleaved 2 of 5 | I | Standard 2 of 5 | S |
| Code 93 | G | ISBN | X ^a |

a. ISBN (X with a 0 modifier character)

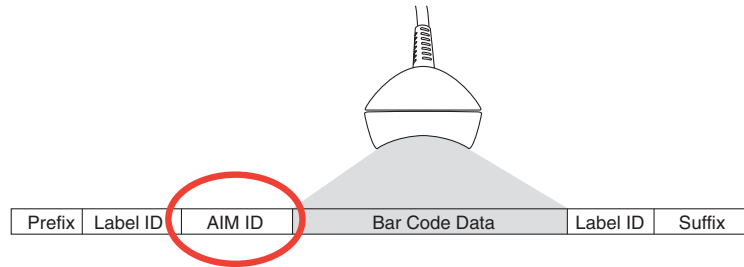
Figure 4-3. AIM ID



| | |
|---|--|
| START / END |  |
| PROGRAMMING BARCODES | |
|  | Disable AIM ID DEFAULT |
| Enable AIM ID |  |

Label ID

A Label ID is a customizable code of up to two ASCII characters (00-FF hex), used to identify a bar code (symbology) type. See [Appendix D, Default Settings](#), for a listing for common symbologies. It can be appended previous to or following the transmitted bar code data depending upon how this option is enabled. This feature provides options for configuring custom Label IDs individually per symbology. If you wish to program the scanner to always include an industry standard label identifier for ALL symbology types, see the previous feature, [AIM ID](#).

To configure a Label ID:

1. Scan the START bar code.
2. Select Label ID position as either BEFORE or AFTER by scanning the appropriate bar code.
3. Scan a bar code to select the symbology for which you wish to configure a custom Label ID.
4. Determine the desired character(s) (you may choose either one or two) which will represent the Label ID for the selected symbology. Next, turn to the [ASCII Chart](#) on the inside back cover of this manual and find the equivalent hex digits associated with your choice of Label ID. For example, if you wish to select an equal sign (=) as a Label ID, the chart indicates its associated hex characters as 3D.
5. Turn to [Appendix C, Alpha-Numeric Pad](#) and scan the bar codes representing the hex characters determined in the previous step. For the example given, the characters '3' and 'D' would be scanned.
6. Scan the END bar code to exit programming mode.

Figure 4-4. Label ID Position Options

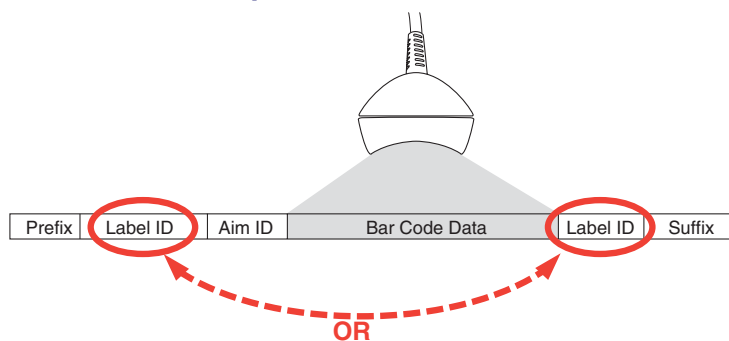

Label ID – cont.

| | |
|---|--|
| START / END |  |
| PROGRAMMING BARCODES | |
|  | Label ID Transmission: Disable |
| Label ID Position: Before Bar Code Data DEFAULT |  |
|  | Label ID Position: After Bar Code Data |
| Set UPC-A Label ID Character(s) |  DEFAULT SETTING FOR THIS FEATURE: A (41 hex) |
|  DEFAULT SETTING FOR THIS FEATURE: A (41 hex) | Set UPC-A w/P2 Addon Label ID Character(s) |
| Set UPC-A w/P5 Addon Label ID Character(s) |  DEFAULT SETTING FOR THIS FEATURE: A (41 hex) |
|  DEFAULT SETTING FOR THIS FEATURE: A (41 hex) | Set UPC-A w/C128 Addon Label ID Character(s) |
| Set UPC-E Label ID Character(s) |  DEFAULT SETTING FOR THIS FEATURE: E (45 hex) |

Label ID – cont.

| START / END |  |
|---|---|
| PROGRAMMING BARCODES | |
|  DEFAULT SETTING FOR THIS FEATURE: E (45 hex) | Set UPC-E w/P2 Addon Label ID Character(s) |
| Set UPC-E w/P5 Addon Label ID Character(s) |  DEFAULT SETTING FOR THIS FEATURE: E (45 hex) |
|  DEFAULT SETTING FOR THIS FEATURE: E (45 hex) | Set UPC-E w/C128 Addon Label ID Character(s) |
| Set EAN-8 Label ID Character(s) |  DEFAULT SETTING FOR THIS FEATURE: FF (4646 hex) |
|  DEFAULT SETTING FOR THIS FEATURE: FF (4646 hex) | Set EAN-8 w/P2 Addon Label ID Character(s) |
| Set EAN-8 w/P5 Addon Label ID Character(s) |  DEFAULT SETTING FOR THIS FEATURE: FF (4646 hex) |
|  DEFAULT SETTING FOR THIS FEATURE: FF (4646 hex) | Set EAN-8 w/C128 Addon Label ID Character(s) |
| Set EAN-13 Label ID Character(s) |  DEFAULT SETTING FOR THIS FEATURE: F (46 hex) |

Label ID – cont.

| START / END |  |
|---|--|
| PROGRAMMING BARCODES | |
|  DEFAULT SETTING FOR THIS FEATURE: F (46 hex) | Set EAN-13 w/P2 Addon Label ID Character(s) |
| Set EAN-13 w/P5 Addon Label ID Character(s) |  DEFAULT SETTING FOR THIS FEATURE: F (46 hex) |
|  DEFAULT SETTING FOR THIS FEATURE: F (46 hex) | Set EAN-13 w/C128 Addon Label ID Character(s) |
| Set ISBN Label ID Character(s) |  DEFAULT SETTING FOR THIS FEATURE: I (49 hex) |
|  DEFAULT SETTING FOR THIS FEATURE: IA (4941 hex) | Set IATA Label ID Character(s) |
| Set GTIN Label ID Character(s) |  DEFAULT SETTING FOR THIS FEATURE: G (47 hex) |
|  DEFAULT SETTING FOR THIS FEATURE: G2 (4732 hex) | Set GTIN w/P2 addon Label ID Character(s) |
| Set GTIN w/P5 addon Label ID Character(s) |  DEFAULT SETTING FOR THIS FEATURE: G5 (4735 hex) |

Label ID – cont.

| | | |
|---|---|---|
| START / END | |  |
| PROGRAMMING BARCODES | | |
|  | Set GTIN w/C128 addon Label ID Character(s) | |
| DEFAULT SETTING FOR THIS FEATURE: G8 (4738 hex) | | |
| Set RSS-14 Label ID Character(s) |  | |
| DEFAULT SETTING FOR THIS FEATURE: R4 (5234 hex) | | |
|  | Set RSS Expanded Label ID Character(s) | |
| DEFAULT SETTING FOR THIS FEATURE: RX (5258 hex) | | |
| Set RSS Limited Label ID Character(s) |  | |
| DEFAULT SETTING FOR THIS FEATURE: RL (524C hex) | | |
|  | Set Code 39 Label ID Character(s) | |
| DEFAULT SETTING FOR THIS FEATURE: * (2A hex) | | |
| Set Pharmacode 39 Label ID Character(s) |  | |
| DEFAULT SETTING FOR THIS FEATURE: A (41 hex) | | |
|  | Set Code 128 Label ID Character(s) | |
| DEFAULT SETTING FOR THIS FEATURE: # (23 hex) | | |
| Set I 2 of 5 Label ID Character(s) |  | |
| DEFAULT SETTING FOR THIS FEATURE: i (69 hex) | | |

Label ID – cont.

| | |
|---|---|
| START / END |  |
| PROGRAMMING BARCODES | |
|  DEFAULT SETTING FOR THIS FEATURE: % (25 hex) | Set Codabar Label ID Character(s) |
| Set Code 93 Label ID Character(s) |  DEFAULT SETTING FOR THIS FEATURE: & (26 hex) |
|  DEFAULT SETTING FOR THIS FEATURE: @ (40 hex) | Set Code 11 Label ID Character(s) |
| Set MSI/Plessey Label ID Character(s) |  DEFAULT SETTING FOR THIS FEATURE: @ (40 hex) |
|  DEFAULT SETTING FOR THIS FEATURE: s (73 hex) | Set Std 2 of 5 Label ID Character(s) |
| Set PDF417 Label ID Character(s) |  DEFAULT SETTING FOR THIS FEATURE: P (5000 hex) |
|  DEFAULT SETTING FOR THIS FEATURE: mP (6D50 hex) | Set Micro PDF417 Label ID Character(s) |





Case Conversion

This feature can convert scanned bar code data to either all lower case (a through z) or all upper case (A through Z) characters.



Case conversion affects ONLY scanned bar code data, and does not affect Label ID, Prefix, Suffix, or other appended data.

NOTE

| | |
|--|---|
| START / END |  |
| PROGRAMMING BARCODES | |
|  | Disable DEFAULT |
| Convert to Upper Case |  |
|  | Convert to Lower Case |

Character Conversion

Character conversion is an eight byte configuration item. The eight bytes are 4 character pairs represented in hexadecimal ASCII values. The first character in the pair is the character that will be converted. The second character in the pair is the character to convert to. If the character to convert in a pair is **FE**, then no conversion is done.

For example, if you have the character conversion configuration item set to the following:

41423132FFFFFFFF

The first pair is **4142** or AB (**41** hex is an ASCII capital A, **42** hex is an ASCII capital B) and the second pair is **3132** or 12 (**31** hex is an ASCII 1, **32** is an ASCII 2). The other two pairs are **FFFF** and **FFFF**.

With the label, AG15TA81, it would look as follows after the character conversion:
BG25TB82.

The A characters were converted to the B character and the 1 characters were converted to the numeral 2 character. Nothing is done with the last two character pairs, since they are all **FE**.



To set Character Conversion:

1. Scan the START/END bar code.
2. Scan the Character Conversion bar code.
3. Determine the desired string. Up to sixteen positions can be determined as in the above example. Next, turn to the [ASCII Chart](#) on the inside back cover of this manual and find the equivalent hex digits needed to fulfill the string.
4. Turn to [Appendix C, Alpha-Numeric Pad](#) and scan the bar codes representing the hex characters determined in the previous step.
5. Scan the START/END bar code to exit Programming Mode.



If less than the expected string of 16 characters are selected, scan the START/END bar code twice to accept the selections and exit Programming Mode.

NOTE

| | |
|--|--|
| START / END |  |
| PROGRAMMING BARCODES | |
|  DEFAULT SETTING FOR THIS FEATURE: FFFFFFFFFFFFFFFF hex (no conversion) | Character Conversion |

Chapter 5

Symbologies

The scanner supports the following symbologies (bar code types). Options for each symbology are included in this chapter.



- | | |
|-----------------------|-------------------------------|
| ·UPC-A | ·Pharmacode 39 |
| ·UPC-E | ·Transmit Function Characters |
| ·EAN-13 | ·Interleaved 2 of 5 |
| ·EAN-8 | ·Codabar |
| ·RSS-14 | ·Code 93 |
| ·RSS Expanded | ·MSI/Plessey |
| ·RSS Limited | ·Standard 2 of 5 |
| ·Code 39 | |
| 2D Symbologies | |
| ·PDF417 | ·Micro PDF417 |

Factory Defaults— for the standard RS-232 interface are indicated in bold text throughout this section. Reference [Appendix D, Default Settings](#) for default exceptions for your interface.

UPC-A

Disable/Enable UPC-A

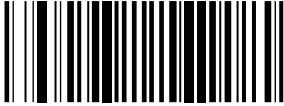

When disabled, the scanner will not read UPC-A bar codes.

| | |
|---|---|
| START / END |  |
| PROGRAMMING BAR CODES | |
|  | Disable UPC-A |
| Enable UPC-A DEFAULT |  |

UPC-A — continued



Check Digit Transmission

Enable this option to transmit the check digit along with UPC-A bar code data.

| | |
|---|--|
| START / END |  |
| PROGRAMMING BAR CODES | |
|  | Don't Send Check Digit |
| Send Check Digit DEFAULT |  |

Expand UPC-A to EAN-13

Expands UPC-A data to the EAN-13 data format. Selecting this feature also changes the symbology ID to match those required for EAN-13.

| | |
|---|--|
| START / END |  |
| PROGRAMMING BAR CODES | |
|  | Don't Expand to EAN-13 DEFAULT |
| Expand to EAN-13 |  |

UPC-A – continued



Number System Transmission

This feature enables/disables transmission of UPC-A System Number.

| | |
|---|---|
| START / END |  |
| PROGRAMMING BAR CODES | |
|  | Disable Number System Transmission |
| Enable Number System Transmission DEFAULT |  |

UPC-A Minimum Reads

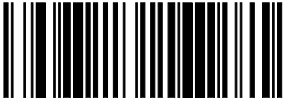
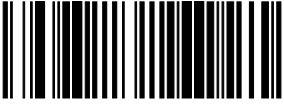
This feature specifies the minimum number of consecutive times a UPC-A label must be decoded before it is accepted as a good read.

| | |
|---|---|
| START / END |  |
| PROGRAMMING BAR CODES | |
|  | Minimum = 1 Read DEFAULT |
| Minimum = 2 Reads |  |
|  | Minimum = 3 Reads |
| Minimum = 4 Reads |  |

UPC-A — continued

UPC-A In-store Minimum Reads

This feature specifies the minimum number of consecutive times an in-store printed label must be decoded before it is accepted as a good read.



| | |
|---|---|
| START / END |  |
| PROGRAMMING BAR CODES | |
|  | Minimum = 1 Read DEFAULT |
| Minimum = 2 Reads |  |
|  | Minimum = 3 Reads |
| Minimum = 4 Reads |  |

UPC-E

The following options apply to the UPC-E symbology.



Disable/Enable UPC-E

When disabled, the scanner will not read UPC-E bar codes.

| | |
|---|---|
| START / END |  |
| PROGRAMMING BAR CODES | |
|  | Disable UPC-E |
| Enable UPC-E DEFAULT |  |

Check Digit Transmission

Enable this option to transmit the check digit along with UPC-E bar code data.

| | |
|---|---|
| START / END |  |
| PROGRAMMING BAR CODES | |
|  | Don't Send Check Digit |
| Send Check Digit DEFAULT |  |

UPC-E — continued



Number System Digit

The Number System Digit (NSD) which is always a zero (0) in the leading position can be optionally included (or not) with scanned bar code data.

| | |
|---|--|
| START / END |  |
| PROGRAMMING BAR CODES | |
|  | Exclude Number System Digit DEFAULT |
| Include Number System Digit |  |

Expand UPC-E to UPC-A

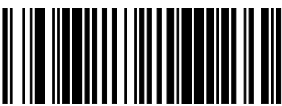

Enables/disables expansion of UPC-E labels to UPC-A. Selecting this feature also changes the symbology ID to match those required for UPC-A.

| | |
|---|--|
| START / END |  |
| PROGRAMMING BAR CODES | |
|  | Don't Expand UPC-E to UPC-A DEFAULT |
| Expand UPC-E to UPC-A |  |

UPC-E – continued





Expand UPC-E to EAN13

Enables/disables expansion of UPC-E labels to EAN-13. Selecting this feature also changes the symbology ID to match those required for EAN-13.

| START / END |  |
|---|---|
| PROGRAMMING BAR CODES | |
|  | Don't Expand UPC-E to EAN-13 DEFAULT |
| Expand UPC-E to EAN-13 |  |

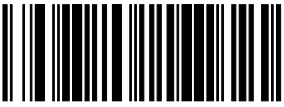
Minimum Reads

This feature specifies the minimum number of consecutive times a UPC-E label must be decoded before it is accepted as a good read.



| START / END |  |
|---|---|
| PROGRAMMING BAR CODES | |
|  | Minimum = 1 Read |
| Minimum = 2 Reads DEFAULT |  |
|  | Minimum = 3 Reads |
| Minimum = 4 Reads |  |

GTIN

The following options apply to the GTIN label data format.

Expand UPC/EAN to GTIN

When this feature is enabled, the scanner will translate UPC/EAN labels to the 14 digit GTIN format.



| | |
|---|--|
| START / END |  |
| PROGRAMMING BAR CODES | |
|  | Don't Expand to GTIN DEFAULT |
| Expand to GTIN |  |

EAN-13

The following options apply to the EAN-13 symbology.



Disable/Enable EAN-13

When disabled, the scanner will not read EAN-13 bar codes.

| | |
|---|---|
| START / END |  |
| PROGRAMMING BAR CODES | |
|  | Disable EAN-13 |
| Enable EAN-13 DEFAULT |  |

Check Digit Transmission



Enable this option to transmit the check digit along with EAN-13 bar code data.

| | |
|---|---|
| START / END |  |
| PROGRAMMING BAR CODES | |
|  | Don't Send Check Digit |
| Send Check Digit DEFAULT |  |

EAN-13 – continued

EAN-13 Flag 1 Character

Enables/disables transmission of an EAN/JAN13 Flag1 character.

| | |
|---|--|
| START / END |  |
| PROGRAMMING BAR CODES | |
|  | Don't Transmit EAN-13 Flag 1 Char |
| Transmit EAN-13 Flag 1 Char DEFAULT |  |



ISBN

When enabled, this feature truncates the leading three digits from labels that contain ISBN (International Standard Book Number) and appends an ISBN check character to the end of the label. These codes are used for books and magazines. Labels with ISBN codes start with "978".

Example:

Bar code data: "9789572222720"





Output: "9572222724"

| | |
|---|--|
| START / END |  |
| PROGRAMMING BAR CODES | |
|  | Disable ISBN DEFAULT |
| Enable ISBN |  |

EAN-13 – continued

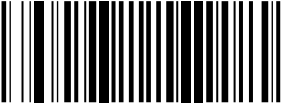
Minimum Reads

This feature specifies the minimum number of consecutive times an EAN-13 label must be decoded before it is accepted as a good read.



| START / END |  |
|---|--|
| PROGRAMMING BAR CODES | |
|  | Minimum = 1 Read DEFAULT |
| Minimum = 2 Reads |  |
|  | Minimum = 3 Reads |
| Minimum = 4 Reads |  |

EAN-8

The following options apply to the EAN-8 symbology.

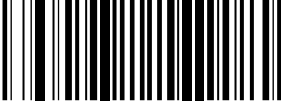

Disable/Enable EAN-8

When disabled, the scanner will not read EAN-8 bar codes.

| | |
|---|--|
| START / END |  |
| PROGRAMMING BAR CODES | |
|  | Disable EAN-8 |
| Enable EAN-8 DEFAULT |  |



Check Digit Transmission

Enable this option to transmit the check Digit along with EAN-8 bar code data.

| | |
|---|--|
| START / END |  |
| PROGRAMMING BAR CODES | |
|  | Don't Send Check Digit |
| Send Check Digit DEFAULT |  |





EAN-8 – continued

Expand EAN-8 to EAN-13— Expands EAN-8 data to the EAN-13 data format. Selecting this feature also changes the symbology ID to match those required for EAN-13.

| | |
|---|---|
| START / END |  |
| PROGRAMMING BAR CODES | |
|  | Don't Expand to EAN-13 DEFAULT |
| Expand to EAN-13 |  |



Minimum Reads

This feature specifies the minimum number of consecutive times an EAN-8 label must be decoded before it is accepted as a good read.

| | |
|---|---|
| START / END |  |
| PROGRAMMING BAR CODES | |
|  | Minimum = 1 Read DEFAULT |
| Minimum = 2 Reads |  |
|  | Minimum = 3 Reads |
| Minimum = 4 Reads |  |



Enable EAN Two-Label

Enables/disables the ability of the scanner to decode EAN two-label pairs.

| | |
|---|--|
| START / END |  |
| PROGRAMMING BAR CODES | |
|  | Disable EAN Two-Label |
| Enable EAN Two-Label |  |

Enable EAN Two-Label Combined

Enables/disables the transmitting of an EAN two label pair as one label.

| | |
|---|--|
| START / END |  |
| PROGRAMMING BAR CODES | |
|  | Disable EAN Two-Label Combined |
| Enable EAN Two-Label Combined |  |



NOTE

Contact Customer Support for advanced programming of Two-Label Pairs.

Add-ons

Add-ons (or supplemental characters) are commonly added to the end of UPC/EAN bar codes. The scanner will read the add-ons if they are enabled and in the field of view. Three add-on types are supported: 2-digit, 5-digit and Code 128 add-ons. Supported options are:

None— This option directs the scanner to ignore add-on portion of a UPC/EAN bar code but still read the main portion of the bar code.

2 Digits— The scanner will optionally read 2-digit add-ons with the UPC/EAN label.

5 Digits— The scanner will optionally read 5-digit add-ons with the UPC/EAN label.

Code 128 Add-on— The scanner will optionally read Code 128 add-ons with the UPC/EAN label.



NOTE

Contact Customer Support for advanced programming of optional and conditional add-ons.

Add-ons – continued



| START / END |  |
|---|--|
| PROGRAMMING BAR CODES | |
|  | Disable Optional 2-Digit Add-ons DEFAULT |
| Enable Optional 2-Digit Add-ons |  |
|  | Disable Optional 5-Digit Add-ons DEFAULT |
| Enable Optional 5-Digit Add-ons |  |
|  | Disable Optional Code 128 Add-ons DEFAULT |
| Enable Optional Code 128 Add-ons |  |

RSS-14

The following options apply to the RSS-14 symbology.



Disable/Enable RSS-14

When this feature is disabled, the scanner will not read RSS-14 bar codes.

| | |
|---|---|
| START / END |  |
| PROGRAMMING BAR CODES | |
|  | Disable RSS-14 DEFAULT |
| Enable RSS-14 |  |

RSS-14 UCC/EAN 128 Emulation





When enabled, RSS-14 bar codes will be translated to the UCC/EAN 128 label data format.

| | |
|---|---|
| START / END |  |
| PROGRAMMING BAR CODES | |
|  | Disable RSS-14 UCC/EAN 128 Emulation DEFAULT |
| Enable RSS-14 UCC/EAN 128 Emulation |  |

RSS-14 – continued

Minimum Reads

This feature specifies the minimum number of consecutive times an RSS-14 label must be decoded before it is accepted as a good read.

| | |
|---|--|
| START / END |  |
| PROGRAMMING BAR CODES | |
|  | Minimum = 1 Read DEFAULT |
| Minimum = 2 Reads |  |
|  | Minimum = 3 Reads |
| Minimum = 4 Reads |  |

RSS-14 – continued



RSS-14 2D Component

This setting enables/disables RSS-14/Micro PDF417 composite labels.



Both RSS-14 and Micro PDF417 must be enabled to read these composite labels.

NOTE



| | |
|---|---|
| START / END |  |
| PROGRAMMING BAR CODES | |
|  | Disable RSS-14 2D Component DEFAULT |
| Enable always on RSS-14 2D Component |  |

RSS Expanded

The following options apply to the RSS Expanded symbology.

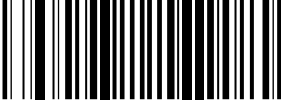

Disable/Enable RSS Expanded

When this feature is disabled, the scanner will not read RSS Expanded bar codes.

| | |
|---|--|
| START / END |  |
| PROGRAMMING BAR CODES | |
|  | Disable RSS Expanded DEFAULT |
| Enable RSS Expanded |  |

RSS Expanded UCC/EAN 128 Emulation

When enabled, RSS Expanded bar codes will be translated to the UCC/EAN 128 label data format.

| | |
|---|--|
| START / END |  |
| PROGRAMMING BAR CODES | |
|  | Disable RSS Expanded UCC/EAN 128 Emulation DEFAULT |
| Enable RSS Expanded UCC/EAN 128 Emulation |  |

RSS Expanded – continued

Length Control

Fixed Length Decoding— When fixed length decoding is enabled, the scanner will decode a bar code if the label length matches one of the configurable fixed lengths.



Variable Length Decoding— When variable length decoding is enabled, the scanner will decode a bar code if the label length falls in the range of the configurable minimum and maximum length.

Configuring Fixed Length Decoding:

1. Scan the START/END bar code.
2. Scan the Fixed Length Decoding bar code.
3. Scan the START/END bar code.
4. Set Length 1 to the first fixed length by following the [RSS Expanded Length 1, Length 2 Programming Instructions](#) below.
5. Set Length 2 to the second fixed length (or to '000' if there is only one fixed length) by following the [RSS Expanded Length 1, Length 2 Programming Instructions](#) below.

Configuring Variable Length Decoding:

1. Scan the START/END bar code.
2. Scan the Variable Length Decoding bar code.
3. Scan the START/END bar code.
4. Set Length 1 to the first variable length by following the [RSS Expanded Length 1, Length 2 Programming Instructions](#) below.
5. Set Length 2 to the second variable length by following the [RSS Expanded Length 1, Length 2 Programming Instructions](#) below.

| | |
|---|---|
| START / END |  |
| PROGRAMMING BAR CODES | |
|  | Variable Length Decoding DEFAULT |
| Fixed Length Decoding |  |

RSS Expanded – continued

RSS Expanded Length 1, Length 2 Programming Instructions

1. Scan the START/END bar code.
2. Scan either the Set Length 1 or Set Length 2 bar code.
3. Turn to [Appendix C, Alpha-Numeric Pad](#) and scan the three digits (zero padded) representing the length in decimal notation.



For RSS Expanded bar codes, only the data characters are included in the length calculations.

NOTE



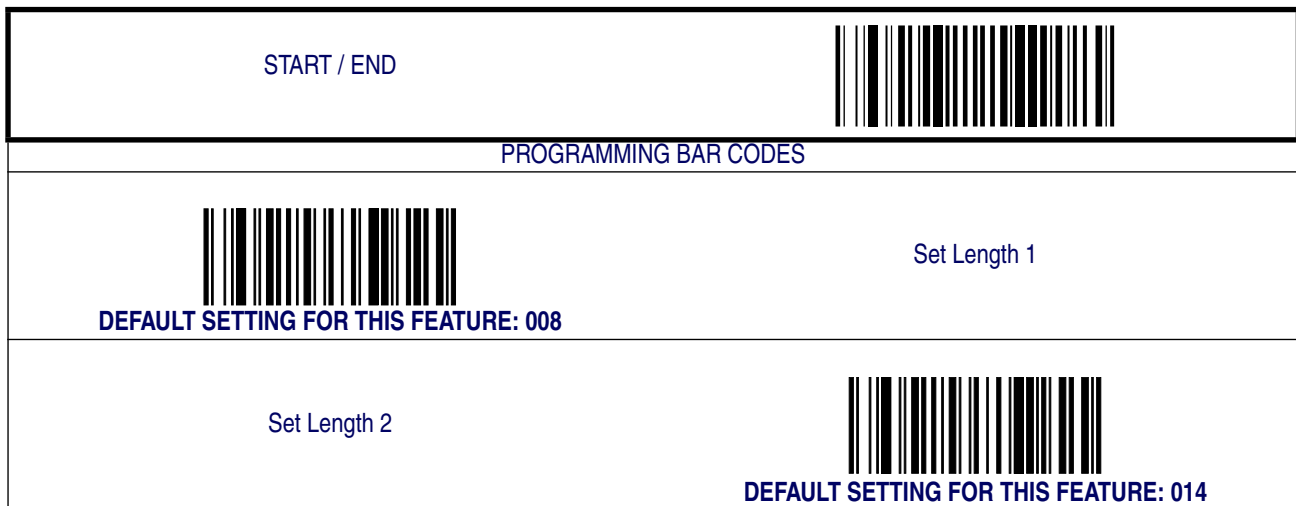

4. Scan the START/END bar code.

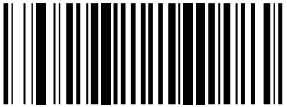

RSS Expanded – continued

Minimum Reads

This feature specifies the minimum number of consecutive times an RSS Expanded label must be decoded before it is accepted as a good read.

| START / END |  |
|--|--|
| PROGRAMMING BAR CODES | |
|  | Minimum = 1 Read DEFAULT |
| Minimum = 2 Reads |  |
|  | Minimum = 3 Reads |
| Minimum = 4 Reads |  |

RSS Expanded – continued



RSS Expanded 2D Component

This setting enables/disables RSS Expanded/Micro PDF417 composite labels.



Both **RSS Expanded** and **Micro PDF417** must be enabled to read these composite labels.

NOTE

| | |
|---|--|
| START / END |  |
| PROGRAMMING BAR CODES | |
|  | Disable RSS Expanded 2D Component DEFAULT |
| Enable always on RSS Expanded 2D Component |  |

RSS Limited

The following options apply to the RSS Limited symbology.

Disable/Enable RSS Limited



When this feature is disabled, the scanner will not read RSS Limited bar codes.

| | |
|---|--|
| START / END |  |
| PROGRAMMING BAR CODES | |
|  | Disable RSS Limited DEFAULT |
| Enable RSS Limited |  |

RSS Limited – continued





RSS Limited UCC/EAN 128 Emulation

When enabled, RSS Limited bar codes will be translated to the UCC/EAN 128 label data format.

| | |
|---|---|
| START / END |  |
| PROGRAMMING BAR CODES | |
|  | Disable RSS Limited UCC/EAN 128 Emulation DEFAULT |
| Enable RSS Limited UCC/EAN 128 Emulation |  |

Minimum Reads

This feature specifies the minimum number of consecutive times an RSS Limited label must be decoded before it is accepted as a good read.

| | |
|---|---|
| START / END |  |
| PROGRAMMING BAR CODES | |
|  | Minimum = 1 Read DEFAULT |
| Minimum = 2 Reads |  |
|  | Minimum = 3 Reads |
| Minimum = 4 Reads |  |

RSS Limited – continued



RSS Limited 2D Component

This setting enables/disables RSS Limited/Micro PDF417 composite labels.



Both RSS Limited and Micro PDF417 must be enabled to read these composite labels.

NOTE



| | |
|---|--|
| START / END |  |
| PROGRAMMING BAR CODES | |
|  | Disable RSS Limited 2D Component DEFAULT |
| Enable always on RSS Limited 2D Component |  |

Code 39

The following options apply to the Code 39 symbology.



Disable/Enable Code 39

When this feature is disabled, the scanner will not read Code 39 bar codes.

| | |
|---|---|
| START / END |  |
| PROGRAMMING BAR CODES | |
|  | Disable Code 39 |
| Enable Code 39 DEFAULT |  |

Check Character Calculation

When enabled, the scanner will calculate the check character of the labels. Turn this option on only when a checksum is present in the Code 39 labels.

| | |
|---|---|
| START / END |  |
| PROGRAMMING BAR CODES | |
|  | Disable Check Char Calculation DEFAULT |
| Enable Check Char Calculation |  |

Code 39 – continued



Check Character Transmit

Enable this option to transmit the check character with scanned bar code data.

| | |
|---|--|
| START / END |  |
| PROGRAMMING BAR CODES | |
|  | Disable Check Char Transmission |
| Enable Check Char Transmission DEFAULT |  |

Start/Stop Characters

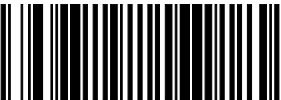

Enables/disables transmission of Code39 start and stop characters.

| | |
|---|--|
| START / END |  |
| PROGRAMMING BAR CODES | |
|  | Don't Transmit Start/Stop Characters DEFAULT |
| Transmit Start/Stop Characters |  |

Code 39 — continued

Code 39 Full ASCII

Enables/disables the translation of Code 39 characters to Code 39 full-ASCII characters.

| | |
|---|---|
| START / END |  |
| PROGRAMMING BAR CODES | |
|  | Disable Code 39 Full ASCII DEFAULT |
| Enable Code 39 Full ASCII |  |

Code 39 — continued

Length Control

Fixed Length Decoding— When fixed length decoding is enabled, the scanner will decode a bar code if the label length matches one of the configurable fixed lengths.



Variable Length Decoding— When variable length decoding is enabled, the scanner will decode a bar code if the label length falls in the range of the configurable minimum and maximum length.

Configuring Fixed Length Decoding:

1. Scan the START/END bar code.
2. Scan the Fixed Length Decoding bar code.
3. Scan the START/END bar code.
4. Set Length 1 to the first fixed length by following the [Code 39 Length 1, Length 2 Programming Instructions](#) below.
5. Set Length 2 to the second fixed length (or to '000' if there is only one fixed length) by following the [Code 39 Length 1, Length 2 Programming Instructions](#) below.

Configuring Variable Length Decoding:

1. Scan the START/END bar code.
2. Scan the Variable Length Decoding bar code.
3. Scan the START/END bar code.
4. Set Length 1 to the first variable length by following the [Code 39 Length 1, Length 2 Programming Instructions](#) below.
5. Set Length 2 to the second variable length by following the [Code 39 Length 1, Length 2 Programming Instructions](#) below.

| | |
|---|--|
| START / END |  |
| PROGRAMMING BAR CODES | |
|  | Variable Length Decoding DEFAULT |
| Fixed Length Decoding |  |

Code 39 – continued

Code 39 Length 1, Length 2 Programming Instructions



1. Scan the START/END bar code.
2. Scan either the Set Length 1 or Set Length 2 bar code.
3. Turn to [Appendix C, Alpha-Numeric Pad](#) and scan the three digits (zero padded) representing the length in decimal notation.



NOTE



For Code 39 bar codes, all check, data and full ASCII shift characters (even if full ASCII is enabled) are included in the length calculations. Start/Stop characters are not included.

4. Scan the START/END bar code.

| | |
|---|--|
| START / END |  |
| PROGRAMMING BAR CODES | |
|  DEFAULT SETTING FOR THIS FEATURE: 003 | Set Length 1 |
| Set Length 2 |  DEFAULT SETTING FOR THIS FEATURE: 050 |

Quiet Zones



This feature enables/disables the requirement that quiet zones must be present for Code 39 bar codes.

| | |
|---|---|
| START / END |  |
| PROGRAMMING BAR CODES | |
|  | Don't require Quiet Zones DEFAULT |
| Require Quiet Zones |  |

Code 39 – continued





Code 39 Stitching

Enables/disables stitching for Code 39 labels. When parts of a Code 39 bar code are presented to the scanner with this feature enabled, the bar code parts will be assembled by the scanner's software, and the data will be decoded if all bar code proofing requirements are met.

| | |
|---|--|
| START / END |  |
| PROGRAMMING BAR CODES | |
|  | Disable Code 39 Stitching DEFAULT |
| Enable Code 39 Stitching |  |

Minimum Reads

This feature specifies the minimum number of consecutive times a Code 39 label must be decoded before it is accepted as a good read.



| | |
|---|--|
| START / END |  |
| PROGRAMMING BAR CODES | |
|  | Minimum = 1 Read DEFAULT |
| Minimum = 2 Reads |  |
|  | Minimum = 3 Reads |
| Minimum = 4 Reads |  |

Pharmacode 39

The following options apply to the Pharmacode 39 symbology.

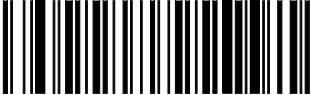

Disable/Enable Pharmacode 39

When this feature is disabled, the scanner will not read Pharmacode 39 bar codes.

| | |
|---|---|
| START / END |  |
| PROGRAMMING BAR CODES | |
|  | Disable Pharmacode 39 DEFAULT |
| Enable Pharmacode 39 |  |

Start/Stop Characters



Enables or disables transmission of Pharmacode 39 start/stop characters.

| | |
|---|---|
| START / END |  |
| PROGRAMMING BAR CODES | |
|  | Don't Transmit Start/Stop Characters DEFAULT |
| Transmit Start/Stop Characters |  |

Pharmacode 39 – continued

Check Character Transmit

Enable this option to transmit the check character with scanned bar code data.







| | |
|---|--|
| START / END |  |
| PROGRAMMING BAR CODES | |
|  | Disable Check Char Transmission |
| Enable Check Char Transmission DEFAULT |  |

Code 128 and UCC/EAN 128

The following options apply to the Code 128 and EAN 128 symbologies.

Code 128— When this feature is disabled, the scanner will not read Code 128 bar codes.

UCC/EAN 128— Enables/disables ability of scanner to translate UCC/EAN 128 labels to the EAN 128 data format.

| | |
|---|---|
| START |  |
| STATE | BARCODE |
| Disable Code 128 |  |
| Enable Code 128 |  |
| Transmit EAN128 labels in Code128 data format |  |
| Transmit EAN128 labels in EAN128 data format |  |
| END |  |



Code 128 and UCC/EAN 128 – continued

Transmit Function Characters

Enables/disables transmission of Code128 function characters 1, 2, 3, and 4.

Function codes are transmitted as follows:

- FNC1 = 80 hex
- FNC2 = 81 hex
- FNC3 = 82 hex
- FNC4 = 83 hex

| | |
|---|---|
| START / END |  |
| PROGRAMMING BAR CODES | |
|  | Don't Transmit Function Characters DEFAULT |
| Transmit Function Characters |  |

Code 128 and UCC/EAN 128 — continued

Length Control

Fixed Length Decoding— When fixed length decoding is enabled, the scanner will decode a bar code if the label length matches one of the configurable fixed lengths.



Variable Length Decoding— When variable length decoding is enabled, the scanner will decode a bar code if the label length falls in the range of the configurable minimum and maximum length.

Configuring Fixed Length Decoding:

1. Scan the START bar code.
2. Scan the Fixed Length Decoding bar code.
3. Scan the END bar code.
4. Set Length 1 to the first fixed length by following the [Code 128 Length 1, Length 2 Programming Instructions](#) below.
5. Set Length 2 to the second fixed length (or to '000' if there is only one fixed length) by following the [Code 128 Length 1, Length 2 Programming Instructions](#) below.

Configuring Variable Length Decoding:

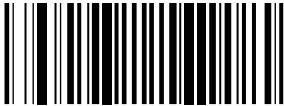
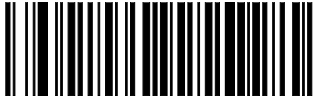
1. Scan the START bar code.
2. Scan the Variable Length Decoding bar code.
3. Scan the END bar code.
4. Set Length 1 to the first variable length by following the [Code 128 Length 1, Length 2 Programming Instructions](#) below.
5. Set Length 2 to the second variable length by following the [Code 128 Length 1, Length 2 Programming Instructions](#) below.

| | |
|---|---|
| START / END |  |
| PROGRAMMING BAR CODES | |
|  | Variable Length Decoding DEFAULT |
| Fixed Length Decoding |  |

Code 128 and UCC/EAN 128 – continued

Code 128 Length 1, Length 2 Programming Instructions



1. Scan the START bar code.
2. Scan either the Set Length 1 or Set Length 2 bar code.
3. Turn to [Appendix C, Alpha-Numeric Pad](#) and scan the three digits (zero padded) representing the length in decimal notation.



For Code 128 bar codes, only the data characters are included in the length calculations.



NOTE

4. Scan the END bar code.

| | |
|--|---|
| START / END |  |
| PROGRAMMING BAR CODES | |
|  DEFAULT SETTING FOR THIS FEATURE: 001 | Set Length 1 |
| Set Length 2 |  DEFAULT SETTING FOR THIS FEATURE: 080 |

Code 128 Conversion to Code 39



Enables/disables expansion of Code 128 labels to Code 39.

| | |
|---|--|
| START / END |  |
| PROGRAMMING BAR CODES | |
|  | Disable DEFAULT |
| Enable |  |

Code 128 and UCC/EAN 128 — continued



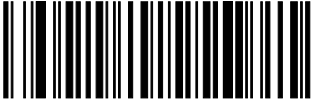

Code 128 Stitching

Enables/disables stitching for Code 128 labels. When parts of a Code 128 bar code are presented to the scanner with this feature enabled, the bar code parts will be assembled by the scanner's software, and the data will be decoded if all bar code proofing requirements are met.

| START / END |  |
|---|---|
| PROGRAMMING BAR CODES | |
|  | Disable Code 128 Stitching DEFAULT |
| Enable Code 128 Stitching |  |

Minimum Reads

This feature specifies the minimum number of consecutive times a Code 128 label must be decoded before it is accepted as a good read.



| START / END |  |
|---|---|
| PROGRAMMING BAR CODES | |
|  | Minimum = 1 Read DEFAULT |
| Minimum = 2 Reads |  |
|  | Minimum = 3 Reads |
| Minimum = 4 Reads |  |

Interleaved 2 of 5

The following options apply to the Interleaved 2 of 5 (I 2 of 5) symbology.

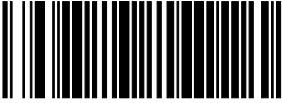

Disable/Enable Interleaved 2 of 5

When this feature is disabled, the scanner will not read Interleaved 2 of 5 bar codes.

| | |
|---|--|
| START / END |  |
| PROGRAMMING BAR CODES | |
|  | Disable Interleaved 2 of 5 DEFAULT |
| Enable Interleaved 2 of 5 |  |

Check Digit Calculation

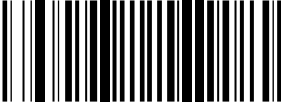

When enabled, the scanner will calculate the check digit of the labels.

| | |
|---|--|
| START / END |  |
| PROGRAMMING BAR CODES | |
|  | Disable Check Digit Calculation DEFAULT |
| Enable Check Digit Calculation |  |

Interleaved 2 of 5 – continued

Check Digit Transmit

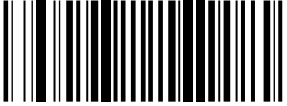
Enable this option to transmit the check digit with scanned bar code data.

| | |
|---|---|
| START / END |  |
| PROGRAMMING BAR CODES | |
|  | Disable Check Digit Calculation DEFAULT |
| Enable Check Digit Calculation |  |

Interleaved 2 of 5 – continued

Length Control

Fixed Length Decoding— When fixed length decoding is enabled, the scanner will decode a bar code if the label length matches one of the configurable fixed lengths.



Variable Length Decoding— When variable length decoding is enabled, the scanner will decode a bar code if the label length falls in the range of the configurable minimum and maximum length.

Configuring Fixed Length Decoding:

1. Scan the START bar code.
2. Scan the Fixed Length Decoding bar code.
3. Scan the END bar code.
4. Set Length 1 to the first fixed length by following the [Interleaved 2 of 5 Length 1, Length 2 Programming Instructions](#) below.
5. Set Length 2 to the second fixed length (or to '000' if there is only one fixed length) by following the [Interleaved 2 of 5 Length 1, Length 2 Programming Instructions](#) below.

Configuring Variable Length Decoding:

1. Scan the START bar code.
2. Scan the Variable Length Decoding bar code.
3. Scan the END bar code.
4. Set Length 1 to the first variable length by following the [Interleaved 2 of 5 Length 1, Length 2 Programming Instructions](#) below.
5. Set Length 2 to the second variable length by following the [Interleaved 2 of 5 Length 1, Length 2 Programming Instructions](#) below.

| | |
|---|--|
| START / END |  |
| PROGRAMMING BAR CODES | |
|  | Variable Length Decoding DEFAULT |
| Fixed Length Decoding |  |

Interleaved 2 of 5 – continued

Interleaved 2 of 5 Length 1, Length 2 Programming Instructions



1. Scan the START bar code.
2. Scan either the Set Length 1 or Set Length 2 bar code.
3. Turn to [Appendix C, Alpha-Numeric Pad](#) and scan the three digits (zero padded) representing the length in decimal notation.



For Interleaved 2 of 5 bar codes, lengths must be an even number. Additionally, all check and data characters are included in the length calculations.

NOTE

4. Scan the END bar code.

| | |
|--|---|
| START / END |  |
| PROGRAMMING BAR CODES | |
|  DEFAULT SETTING FOR THIS FEATURE: 006 | Set Length 1 |
| Set Length 2 |  DEFAULT SETTING FOR THIS FEATURE: 050 |

Interleaved 2 of 5 – continued

Interleaved 2 of 5 Stitching

Enables/disables stitching for Interleaved 2 of 5 labels. When parts of an Interleaved 2 of 5 bar code are presented to the scanner with this feature enabled, the bar code parts will be assembled by the scanner's software, and the data will be decoded if all bar code proofing requirements are met.



Only functions when **Fixed Length Decoding** is enabled.





NOTE

| | |
|-------------------------------------|---|
| START / END | |
| PROGRAMMING BAR CODES | |
| | Disable Interleaved 2 of 5 Stitching DEFAULT |
| Enable Interleaved 2 of 5 Stitching | |

Interleaved 2 of 5 – continued

Minimum Reads

This feature specifies the minimum number of consecutive times an Interleaved 2 of 5 label must be decoded before it is accepted as a good read.



| START / END |  |
|---|--|
| PROGRAMMING BAR CODES | |
|  | Minimum = 1 Read DEFAULT |
| Minimum = 2 Reads |  |
|  | Minimum = 3 Reads |
| Minimum = 4 Reads |  |

Codabar

The following options apply to the Codabar symbology.

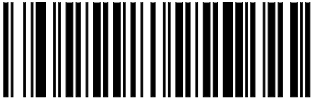

Disable/Enable Codabar

When this feature is disabled, the scanner will not read Codabar bar codes.

| | |
|---|--|
| START / END |  |
| PROGRAMMING BAR CODES | |
|  | Disable Codabar DEFAULT |
| Enable Codabar |  |

Check Character Verification

When enabled, the scanner will verify the check character of the labels.

| | |
|---|--|
| START / END |  |
| PROGRAMMING BAR CODES | |
|  | Disable Check Char Verification DEFAULT |
| Enable Check Char Verification |  |

Codabar — continued

Check Character Transmit

Enable this option to transmit the check character with scanned bar code data.

| | |
|---|---|
| START / END |  |
| PROGRAMMING BAR CODES | |
|  | Disable Check Char Transmission |
| Enable Check Char Transmission DEFAULT |  |

Codabar — continued

Length Control

Fixed Length Decoding— When fixed length decoding is enabled, the scanner will decode a bar code if the label length matches one of the configurable fixed lengths.



Variable Length Decoding— When variable length decoding is enabled, the scanner will decode a bar code if the label length falls in the range of the configurable minimum and maximum length.

Configuring Fixed Length Decoding:

1. Scan the START bar code.
2. Scan the Fixed Length Decoding bar code.
3. Scan the END bar code.
4. Set Length 1 to the first fixed length by following the [Codabar Length 1, Length 2 Programming Instructions](#) below.
5. Set Length 2 to the second fixed length (or to '000' if there is only one fixed length) by following the [Codabar Length 1, Length 2 Programming Instructions](#) below.

Configuring Variable Length Decoding:

1. Scan the START bar code.
2. Scan the Variable Length Decoding bar code.
3. Scan the END bar code.
4. Set Length 1 to the first variable length by following the [Codabar Length 1, Length 2 Programming Instructions](#) below.
5. Set Length 2 to the second variable length by following the [Codabar Length 1, Length 2 Programming Instructions](#) below.

| | |
|---|--|
| START / END |  |
| PROGRAMMING BAR CODES | |
|  | Variable Length Decoding DEFAULT |
| Fixed Length Decoding |  |

Codabar – continued

Codabar Length 1, Length 2 Programming Instructions



1. Scan the START bar code.
2. Scan either the Set Length 1 or Set Length 2 bar code.
3. Turn to [Appendix C, Alpha-Numeric Pad](#) and scan the three digits (zero padded) representing the length in decimal notation.



For Codabar bar codes, all start, stop, check and data characters are included in the length calculations.



NOTE

4. Scan the END bar code.

| | |
|--|---|
| START / END |  |
| PROGRAMMING BAR CODES | |
|  DEFAULT SETTING FOR THIS FEATURE: 003 | Set Length 1 |
| Set Length 2 |  DEFAULT SETTING FOR THIS FEATURE: 050 |

Quiet Zones





This feature enable/disables the requirement that quiet zones must be present for Codabar bar codes.

| | |
|---|---|
| START / END |  |
| PROGRAMMING BAR CODES | |
|  Don't require Quiet Zones DEFAULT | |
| Require Quiet Zones |  |

Codabar – continued



Start/Stop Character Type

Codabar has four pairs of Start/Stop patterns. Select one pair to match your application.

| | |
|---|---|
| START / END |  |
| PROGRAMMING BAR CODES | |
|  | Start/Stop Type: ABCD/TN*E |
| Start/Stop Type: ABCD/ABCD |  |
|  | Start/Stop Type: abcd/tn*e |
| Start/Stop Type: abcd/abcd DEFAULT |  |

Start/Stop Character Transmission



The transmission of start and end characters of Codabar is selected below.

| | |
|---|--|
| START / END |  |
| PROGRAMMING BAR CODES | |
|  | Disable Start/Stop Char Transmission |
| Enable Start/Stop Char Transmission DEFAULT |  |

Codabar – continued

Start/Stop Character Match

This feature enables/disables the requirement that start and stop characters match.

| | |
|---|---|
| START / END |  |
| PROGRAMMING BAR CODES | |
|  | Disable Start/Stop Char Match DEFAULT |
| Enable Start/Stop Char Match |  |



Codabar Stitching

Enables/disables stitching for Codabar labels. When parts of a Codabar label are presented to the scanner with this feature enabled, the bar code parts will be assembled by the scanner's software, and the data will be decoded if all bar code proofing requirements are met.



Only functions when [Fixed Length Decoding](#) is enabled.





NOTE

| | |
|---|---|
| START / END |  |
| PROGRAMMING BAR CODES | |
|  | Disable Codabar Stitching DEFAULT |
| Enable Codabar Stitching |  |

Codabar — continued

Minimum Reads

This feature specifies the minimum number of consecutive times a Codabar label must be decoded before it is accepted as a good read.



| | |
|---|--|
| START / END |  |
| PROGRAMMING BAR CODES | |
|  | Minimum = 1 Read DEFAULT |
| Minimum = 2 Reads |  |
|  | Minimum = 3 Reads |
| Minimum = 4 Reads |  |

Code 93

The following options apply to the Code 93 symbology.

Disable/Enable Code 93

When this feature is disabled, the scanner will not read Code 93 bar codes.

| | |
|---|---|
| START / END |  |
| PROGRAMMING BAR CODES | |
|  | Disable Code 93 DEFAULT |
| Enable Code 93 |  |

Code 93 – continued

Length Control

Fixed Length Decoding— When fixed length decoding is enabled, the scanner will decode a bar code if the label length matches one of the configurable fixed lengths.



Variable Length Decoding— When variable length decoding is enabled, the scanner will decode a bar code if the label length falls in the range of the configurable minimum and maximum length.

Configuring Fixed Length Decoding:

1. Scan the START/END bar code.
2. Scan the Fixed Length Decoding bar code.
3. Scan the START/END bar code.
4. Set Length 1 to the first fixed length by following the [Code 93 Length 1, Length 2 Programming Instructions](#) below.
5. Set Length 2 to the second fixed length (or to '000' if there is only one fixed length) by following the [Code 93 Length 1, Length 2 Programming Instructions](#) below.

Configuring Variable Length Decoding:

1. Scan the START/END bar code.
2. Scan the Variable Length Decoding bar code.
3. Scan the START/END bar code.
4. Set Length 1 to the first variable length by following the [Code 93 Length 1, Length 2 Programming Instructions](#) below.
5. Set Length 2 to the second variable length by following the [Code 93 Length 1, Length 2 Programming Instructions](#) below.

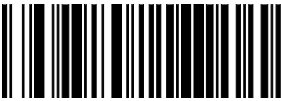
| | |
|---|--|
| START / END |  |
| PROGRAMMING BAR CODES | |
|  | Variable Length Decoding DEFAULT |
| Fixed Length Decoding |  |

Code 93 — continued

Code 93 Length 1, Length 2 Programming Instructions



1. Scan the START bar code.
2. Scan either the Set Length 1 or Set Length 2 bar code.
3. Turn to [Appendix C, Alpha-Numeric Pad](#) and scan the three digits (zero padded) representing the length in decimal notation.



For Code 93 bar codes, only the data characters are included in the length calculations.

NOTE



4. Scan the END bar code.

| | |
|--|---|
| START / END |  |
| PROGRAMMING BAR CODES | |
|  DEFAULT SETTING FOR THIS FEATURE: 001 | Set Length 1 |
| Set Length 2 |  DEFAULT SETTING FOR THIS FEATURE: 050 |

Code 93 – continued





Code 93 Stitching

Enables/disables stitching for Code 93 bar codes. When parts of a Code 93 label are presented to the scanner with this feature enabled, the bar code parts will be assembled by the scanner's software, and the data will be decoded if all bar code proofing requirements are met.

| | |
|---|--|
| START / END |  |
| PROGRAMMING BAR CODES | |
|  | Disable Code 93 Stitching DEFAULT |
| Enable Code 93 Stitching |  |

Minimum Reads

This feature specifies the minimum number of consecutive times a Code 93 label must be decoded before it is accepted as a good read.



| | |
|---|--|
| START / END |  |
| PROGRAMMING BAR CODES | |
|  | Minimum = 1 Read DEFAULT |
| Minimum = 2 Reads |  |
|  | Minimum = 3 Reads |
| Minimum = 4 Reads |  |

MSI/Plessey

The following options apply to the MSI/Plessey symbology.



Disable/Enable MSI/Plessey

When this feature is disabled, the scanner will not read MSI/Plessey bar codes.

| | |
|---|---|
| START / END |  |
| PROGRAMMING BAR CODES | |
|  | Disable MSI/Plessey DEFAULT |
| Enable MSI/Plessey |  |

Check Digit Verification



This feature specifies whether one or two check digits are to be calculated and verified.

| | |
|---|---|
| START / END |  |
| PROGRAMMING BAR CODES | |
|  | Disable Check Digit Verification DEFAULT |
| Enable Check Digit Verification |  |

MSI/Plessey – continued



Check Digit Transmit

When this option is enabled, the scanner will transmit one-digit or two-digit check digits, depending upon the setting for check digit verification.

| | |
|---|--|
| START / END |  |
| PROGRAMMING BAR CODES | |
|  | Disable Check Digit Transmission |
| Enable Check Digit Transmission DEFAULT |  |

Number of Check Characters

Specifies number of MSI/Plessey check characters to be calculated and verified

| | |
|---|--|
| START / END |  |
| PROGRAMMING BAR CODES | |
|  | 1 Check Character DEFAULT |
| 2 Check Characters |  |

MSI/Plessey – continued

Length Control

Fixed Length Decoding— When fixed length decoding is enabled, the scanner will decode a bar code if the label length matches one of the configurable fixed lengths.



Variable Length Decoding— When variable length decoding is enabled, the scanner will decode a bar code if the label length falls in the range of the configurable minimum and maximum length.

Configuring Fixed Length Decoding:

1. Scan the START/END bar code.
2. Scan the Fixed Length Decoding bar code.
3. Scan the START/END bar code.
4. Set Length 1 to the first fixed length by following the [MSI/Plessey Length 1, Length 2 Programming Instructions](#) below.
5. Set Length 2 to the second fixed length (or to '000' if there is only one fixed length) by following the [MSI/Plessey Length 1, Length 2 Programming Instructions](#) below.

Configuring Variable Length Decoding:

1. Scan the START/END bar code.
2. Scan the Variable Length Decoding bar code.
3. Scan the START/END bar code.
4. Set Length 1 to the first variable length by following the [MSI/Plessey Length 1, Length 2 Programming Instructions](#) below.
5. Set Length 2 to the second variable length by following the [MSI/Plessey Length 1, Length 2 Programming Instructions](#) below.

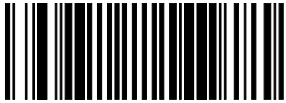
| | |
|---|---|
| START / END |  |
| PROGRAMMING BAR CODES | |
|  | Variable Length Decoding DEFAULT |
| Fixed Length Decoding |  |

MSI/Plessey – continued

MSI/Plessey Length 1, Length 2 Programming Instructions



1. Scan the START bar code.
2. Scan either the Set Length 1 or Set Length 2 bar code.
3. Turn to [Appendix C, Alpha-Numeric Pad](#) and scan the three digits (zero padded) representing the length in decimal notation.



NOTE

For MSI/Plessey bar codes, all check and data characters are included in the length calculations.

4. Scan the END bar code.

| | |
|--|---|
| START / END |  |
| PROGRAMMING BAR CODES | |
|  DEFAULT SETTING FOR THIS FEATURE: 004 | Set Length 1 |
| Set Length 2 |  DEFAULT SETTING FOR THIS FEATURE: 016 |

MSI/Plessey – continued



MSI/Plessey Stitching

Enables/disables stitching for MSI/Plessey bar codes. When parts of an MSI/Plessey label are presented to the scanner with this feature enabled, the bar code parts will be assembled by the scanner's software, and the data will be decoded if all bar code proofing requirements are met.



Only functions when [Fixed Length Decoding](#) is enabled.

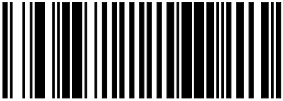



NOTE

| | |
|---|--|
| START / END |  |
| PROGRAMMING BAR CODES | |
|  | Disable MSI/Plessey Stitching DEFAULT |
| Enable MSI/Plessey Stitching |  |

MSI/Plessey – continued

Minimum Reads

This feature specifies the minimum number of consecutive times an MSI/Plessey label must be decoded before it is accepted as a good read.



| START / END |  |
|---|--|
| PROGRAMMING BAR CODES | |
|  | Minimum = 1 Read DEFAULT |
| Minimum = 2 Reads |  |
|  | Minimum = 3 Reads |
| Minimum = 4 Reads |  |

Standard 2 of 5

The following options apply to the Standard 2 of 5 symbology.



Disable/Enable Standard 2 of 5

When this feature is disabled, the scanner will not read Standard 2 of 5 bar codes.

| | |
|---|---|
| START / END |  |
| PROGRAMMING BAR CODES | |
|  | Disable Std 2 of 5 DEFAULT |
| Enable Std 2 of 5 |  |

Check Digit Verification



When enabled, the scanner will verify the check digit of the labels.

| | |
|---|---|
| START / END |  |
| PROGRAMMING BAR CODES | |
|  | Disable Check Digit Verification DEFAULT |
| Enable Check Digit Verification |  |

Standard 2 of 5 – continued

Check Digit Transmit

When this option is enabled, the scanner will transmit the check digit.

| | |
|---|--|
| START / END |  |
| PROGRAMMING BAR CODES | |
|  | Disable Check Digit Transmission |
| Enable Check Digit Transmission DEFAULT |  |

Standard 2 of 5 — continued

Length Control

Fixed Length Decoding— When fixed length decoding is enabled, the scanner will decode a bar code if the label length matches one of the configurable fixed lengths.



Variable Length Decoding— When variable length decoding is enabled, the scanner will decode a bar code if the label length falls in the range of the configurable minimum and maximum length.

Configuring Fixed Length Decoding:

1. Scan the START/END bar code.
2. Scan the Fixed Length Decoding bar code.
3. Scan the START/END bar code.
4. Set Length 1 to the first fixed length by following the [Standard 2 of 5 Length 1, Length 2 Programming Instructions](#) below.
5. Set Length 2 to the second fixed length (or to '000' if there is only one fixed length) by following the [Standard 2 of 5 Length 1, Length 2 Programming Instructions](#) below.

Configuring Variable Length Decoding:

1. Scan the START/END bar code.
2. Scan the Variable Length Decoding bar code.
3. Scan the START/END bar code.
4. Set Length 1 to the first variable length by following the [Standard 2 of 5 Length 1, Length 2 Programming Instructions](#) below.
5. Set Length 2 to the second variable length by following the [Standard 2 of 5 Length 1, Length 2 Programming Instructions](#) below.

| | |
|---|---|
| START / END |  |
| PROGRAMMING BAR CODES | |
|  | Variable Length Decoding DEFAULT |
| Fixed Length Decoding |  |

Standard 2 of 5 – continued

Standard 2 of 5 Length 1, Length 2 Programming Instructions



1. Scan the START bar code.
2. Scan either the Set Length 1 or Set Length 2 bar code.
3. Turn to [Appendix C, Alpha-Numeric Pad](#) and scan the three digits (zero padded) representing the length in decimal notation.



For Standard 2 of 5 bar codes, all check and data characters are included in the length calculations.

NOTE

4. Scan the END bar code.

| | |
|--|---|
| START / END |  |
| PROGRAMMING BAR CODES | |
|  DEFAULT SETTING FOR THIS FEATURE: 008 | Set Length 1 |
| Set Length 2 |  DEFAULT SETTING FOR THIS FEATURE: 050 |

Standard 2 of 5 – continued

Standard 2 of 5 Stitching

Enables/disables stitching for Standard 2 of 5 bar codes. When parts of a Standard 2 of 5 label are presented to the scanner with this feature enabled, the bar code parts will be assembled by the scanner's software, and the data will be decoded if all bar code proofing requirements are met.



Only functions when **Fixed Length Decoding** is enabled.





NOTE

| | |
|---|--|
| START / END |  |
| PROGRAMMING BAR CODES | |
|  | Disable Std 2 of 5 Stitching DEFAULT |
| Enable Std 2 of 5 Stitching |  |

Standard 2 of 5 – continued

Minimum Reads

This feature specifies the minimum number of consecutive times a Standard 2 of 5 label must be decoded before it is accepted as a good read.



| | |
|---|---|
| START / END |  |
| PROGRAMMING BAR CODES | |
|  | Minimum = 1 Read DEFAULT |
| Minimum = 2 Reads |  |
|  | Minimum = 3 Reads |
| Minimum = 4 Reads |  |

PDF417

The following options apply to the PDF417 symbology.



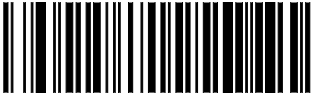

Disable/Enable PDF417

When this feature is disabled, the scanner will not read PDF417 bar codes.

| | |
|---|---|
| START / END |  |
| PROGRAMMING BAR CODES | |
|  | Disable PDF417 DEFAULT |
| Enable PDF417 |  |

PDF417 Minimum Reads

This feature specifies the minimum number of consecutive times a PDF417 label must be decoded before it is accepted as a good read.

| | |
|---|---|
| START / END |  |
| PROGRAMMING BAR CODES | |
|  | Minimum = 1 Read DEFAULT |
| Minimum = 2 Reads |  |
|  | Minimum = 3 Reads |
| Minimum = 4 Reads |  |

PDF417 – continued

Length Control

Fixed Length Decoding— When fixed length decoding is enabled, the scanner will decode a bar code if the label length matches one of the configurable fixed lengths.



Variable Length Decoding— When variable length decoding is enabled, the scanner will decode a bar code if the label length falls in the range of the configurable minimum and maximum length.

Configuring Fixed Length Decoding:

1. Scan the START/END bar code.
2. Scan the Fixed Length Decoding bar code.
3. Set Length 1 to the first fixed length by following the [PDF417 Length 1, Length 2 Programming Instructions](#) below.
4. Set Length 2 to the second fixed length (or to '000' if there is only one fixed length) by following the [PDF417 Length 1, Length 2 Programming Instructions](#) below.
5. Scan the START/END bar code.

Configuring Variable Length Decoding:

1. Scan the START/END bar code.
2. Scan the Variable Length Decoding bar code.
3. Set Length 1 to the first variable length by following the [PDF417 Length 1, Length 2 Programming Instructions](#) below.
4. Set Length 2 to the second variable length by following the [PDF417 Length 1, Length 2 Programming Instructions](#) below.
5. Scan the START/END bar code.

| | |
|---|--|
| START / END |  |
| PROGRAMMING BAR CODES | |
|  | Variable Length Decoding DEFAULT |
| Fixed Length Decoding |  |

PDF417 – continued

PDF417 Length 1, Length 2 Programming Instructions



1. Scan the START bar code.
2. Scan either the Set Length 1 or Set Length 2 bar code.
3. Turn to [Appendix C, Alpha-Numeric Pad](#) and scan the three digits (zero padded) representing the length in decimal notation.



NOTE

Length 2 is the maximum label length if in variable length mode, or the second fixed length if in fixed length mode. Length includes the bar code's check and data characters.

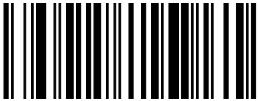
4. Scan the END bar code.



| | |
|--|---|
| START / END |  |
| PROGRAMMING BAR CODES | |
|  DEFAULT SETTING FOR THIS FEATURE: 001 | Set Length 1 |
| Set Length 2 |  DEFAULT SETTING FOR THIS FEATURE: 800 |

Micro PDF417

The following options apply to the Micro PDF417 symbology.

Disable/Enable Micro PDF417

When this feature is disabled, the scanner will not read Micro PDF417 bar codes.



| | |
|---|--|
| START / END |  |
| PROGRAMMING BAR CODES | |
|  | Disable Micro PDF417 DEFAULT |
| Enable Micro PDF417 |  |

Micro PDF417 — continued

Micro PDF 128 Emulation

Specifies which Label I.D. to use for Micro PDF labels when Code 128 or EAN128 emulation is active.





- If **Micro PDF 128 Emulation** is disabled, and **AIM ID** is enabled, and the scanner is performing EAN128 or Code 128 emulation; the MicroPDF AIM I.D. type is used (]L3,]L4 or]L5).
- If **Micro PDF 128 Emulation** is disabled, and the scanner is performing EAN128 or Code 128 emulation; the scanned label type is recognized as MicroPDF.
- If **Micro PDF 128 Emulation** is enabled, and **AIM ID** is enabled, and the scanner is performing EAN128 or Code 128 emulation; the Code 128 / EAN 128 AIM I.D. type is used (]C0,]C1 or]C2).
- If **Micro PDF 128 Emulation** is enabled, and the scanner is performing EAN128 or Code 128 emulation; the label type is changed to either EAN128 or Code 128.

| | |
|--|---|
| START / END |  |
| PROGRAMMING BAR CODES | |
|  | Disable Micro PDF 128 Emulation DEFAULT |
| Enable Micro PDF 128 Emulation |  |

Micro PDF417 – continued

Micro PDF417 Minimum Reads

This feature specifies the minimum number of consecutive times a Micro PDF417 label must be decoded before it is accepted as a good read.

| | |
|---|---|
| START / END |  |
| PROGRAMMING BAR CODES | |
|  | Minimum = 1 Read DEFAULT |
| Minimum = 2 Reads |  |
|  | Minimum = 3 Reads |
| Minimum = 4 Reads |  |

Micro PDF417 — continued

Length Control

Fixed Length Decoding— When fixed length decoding is enabled, the scanner will decode a bar code if the label length matches one of the configurable fixed lengths.



Variable Length Decoding— When variable length decoding is enabled, the scanner will decode a bar code if the label length falls in the range of the configurable minimum and maximum length.

Configuring Fixed Length Decoding:

1. Scan the START/END bar code.
2. Scan the Fixed Length Decoding bar code.
3. Set Length 1 to the first fixed length by following the [Micro PDF417 Length 1, Length 2 Programming Instructions](#) below.
4. Set Length 2 to the second fixed length (or to '000' if there is only one fixed length) by following the [Micro PDF417 Length 1, Length 2 Programming Instructions](#) below.
5. Scan the START/END bar code.

Configuring Variable Length Decoding:

1. Scan the START/END bar code.
2. Scan the Variable Length Decoding bar code.
3. Set Length 1 to the first variable length by following the [Micro PDF417 Length 1, Length 2 Programming Instructions](#) below.
4. Set Length 2 to the second variable length by following the [Micro PDF417 Length 1, Length 2 Programming Instructions](#) below.
5. Scan the START/END bar code.

| | |
|---|---|
| START / END |  |
| PROGRAMMING BAR CODES | |
|  | Variable Length Decoding DEFAULT |
| Fixed Length Decoding |  |

Micro PDF417 – continued

Micro PDF417 Length 1, Length 2 Programming Instructions

1. Scan the START bar code.
2. Scan either the Set Length 1 or Set Length 2 bar code.
3. Turn to [Appendix C, Alpha-Numeric Pad](#) and scan the three digits (zero padded) representing the length in decimal notation.



NOTE

Length 2 is the maximum label length if in variable length mode, or the second fixed length if in fixed length mode. Length includes the bar code's check and data characters.

4. Scan the END bar code.

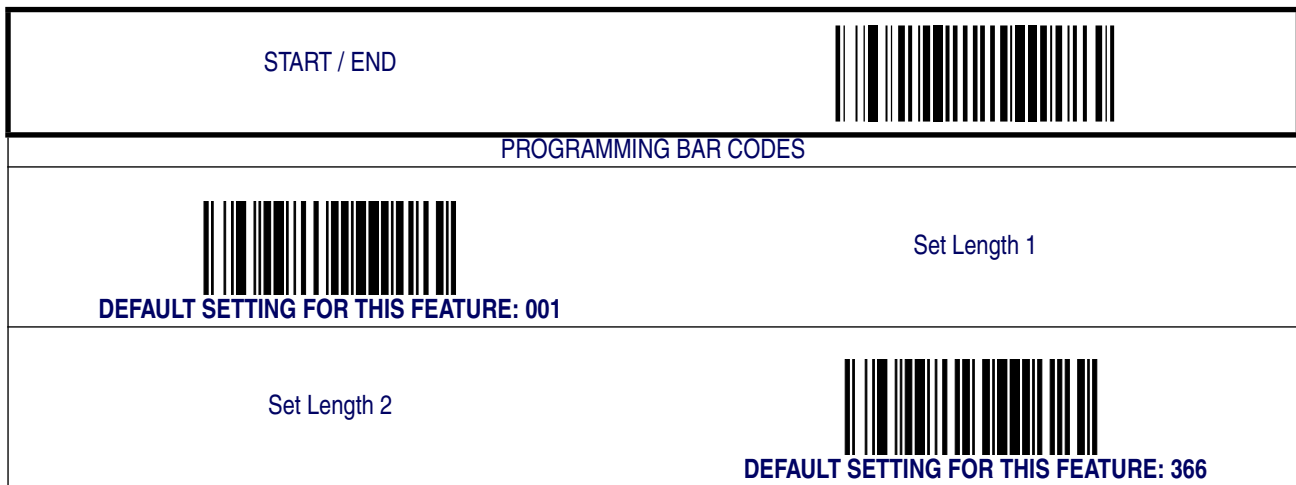

Chapter A

Product Specifications

Optical and Read Performance Parameters

| Parameter | Specification |
|-------------------------------------|--------------------------------|
| Scan Volume | 80 cubic inches |
| Scan Pattern | 100 lines |
| Scan Rate | 1170 Digital Scan Lines/second |
| Minimum Resolution | 5 mil |
| Depth of Field (100% UPC Labels) | 0 ~ 8" |
| Minimum Print Contrast Ratio | 25% |
| Skew (Yaw) | $\pm 75^\circ$ |
| Pitch | $\pm 65^\circ$ |
| Roll | Between 0 and 360° |

Scanner Dimensions

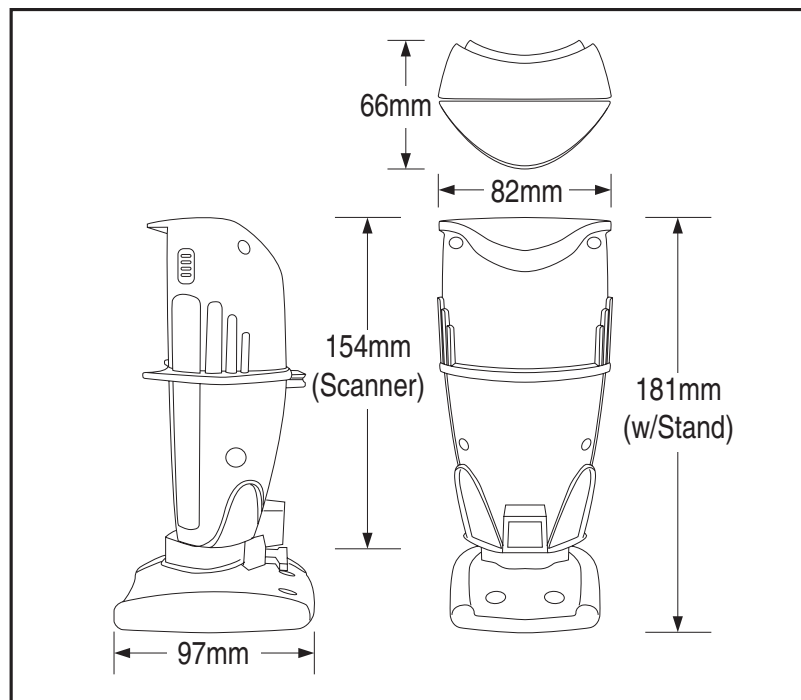

Physical Properties

| Parameter | Specification |
|-----------------------------------|--|
| Dimensions (Scanner only): | 66mm x 82mm x 154mm (2.6" x 3.23" x 6") |
| Dimensions (Scanner w/ Stand): | 97mmx 82mm x 181mm (3.82" x 3.23" x 7.13") |
| Weight (Scanner) | 9 oz. |
| Weight (Base Station) | 15.7 oz. |

Electrical Parameters

| Parameter | Specification |
|-------------------------|--|
| Operating Voltage | (Two Models) 5V unit = 5.0V ± 5% 12V unit = 8-14V ± 5% |
| Input Current | |
| Operating (idle) | <350mA |
| Operating (label read) | <450 mA |
| Surge Current (< 30 ms) | <650mA |

Environmental Parameters

| Parameter | Specification |
|--------------------------------|---|
| Mechanical Shock | Multi 1.2m drops |
| Contaminants Water and Dust | IP52 |
| Temperature Ranges: | |
| Operating | 32° F to +104° F (0° C to +40° C) |
| Storage | -40° F to +158° F (-40° C to + 70°C) |
| Ambient Light Indoor | <6000 lux |
| Ambient Light Outdoor | <86,100 lux |
| Humidity | 5 to 95% non-condensing |
| Beeper/Speaker | 70-85dBA at a distance of 3'-3" (1 meter) |
| Vibration | Retail/Office |

Other Parameters

| Parameter | Specification |
|-------------|------------------|
| EAS Support | YES (Checkpoint) |

Chapter B

Cable Pinouts

Standard Cable Pinouts (Primary Interface Cables)

RS-232

- 1
- 2 CTS
- 3
- 4 RTS
- 5 RXD
- 6 TXD
- 7
- 8 VCC IN
- 9 GND
- 10

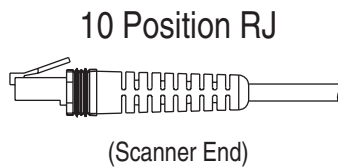
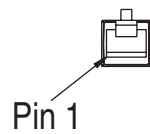

IBM Port 5B/9B/17

- 1
- 2
- 3
- 4 DATA -
- 5
- 6 DATA +
- 7
- 8 VCC_IN
- 9 GND
- 10

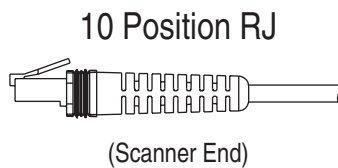
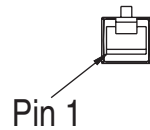

IBM USB

- 1
- 2
- 3
- 4 D -
- 5
- 6 D +
- 7
- 8 VIN
- 9 GND
- 10

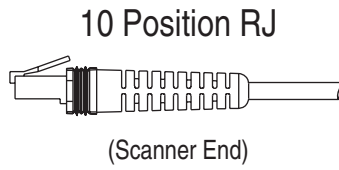
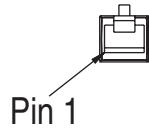

USB & USB Keyboard

- 1
- 2
- 3
- 4 D -
- 5
- 6 D +
- 7
- 8 VBUS_VIN
- 9 GND
- 10

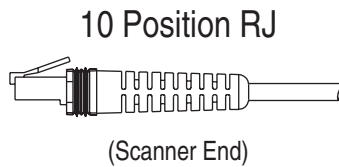
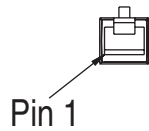

Wand Emulation

- 1
- 2
- 3 WAND~
- 4
- 5
- 6
- 7
- 8 VCC_IN
- 9 GND
- 10

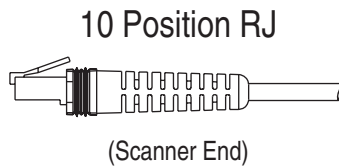
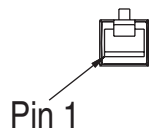

Keyboard Wedge

- 1
- 2 KB_DATA
- 3 AT_CLK
- 4 KB_CLK
- 5
- 6 AT_DATA
- 7
- 8 VCC_IN
- 9 GND
- 10

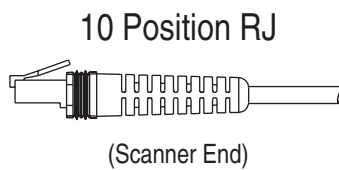
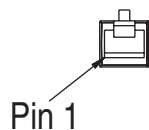

Chapter C

Alpha-Numeric Pad



A



B



C



D



E

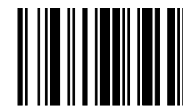

F

Alpha-Numeric Pad



Appendix D

Default Settings

Standard Feature Defaults

The table immediately below lists the default settings for the standard RS-232 interface.

| Feature | Std. RS-232 Setting | Interface-Specific Exceptions | Page # |
|-----------------------------|---------------------|--|--------|
| Double Read Timeout | 0.6 Second | | 2-1 |
| Label Gone Timeout | 200 msec | | 2-4 |
| Sleep Mode | 10 minutes | | 2-5 |
| Power On Alert | Enable | | 2-7 |
| Good Read: When to Indicate | After Decode | | 2-8 |
| Good Read Beep Control | Enable | | 2-9 |
| Good Read Beep Frequency | Medium | | 2-9 |
| Good Read Beep Length | 60 msec | | 2-10 |
| Good Read Beep Volume | High | | 2-11 |
| Target Mode: Active Time | Medium Duration | | 2-13 |
| Target Mode: Linger Time | Medium Duration | | 2-14 |
| Wake Up Intensity | 10% | | 2-15 |
| Interface Selection | RS-232 Std. | Interface as required IBM Default: IBM Port 9B Wincor/Nixdorf Default: RS-232-WN Keyboard Wedge Default: USB Keyboard | 3-3 |

| Feature | Std. RS-232 Setting | Interface-Specific Exceptions | Page # |
|---------------------------------|---------------------------|---|--------|
| Obey/Ignore Host Commands | Obey Host Commands | | 3-7 |
| Host Transmission Buffers | Buffers=2 | IBM: Buffers=1 Wincor/Nixdorf: Buffers=1 | 3-8 |
| Baud Rate | 9600 Baud | | 3-9 |
| Data Bits | 8 Data Bits | | 3-10 |
| Stop Bits | 1 Stop Bit | | 3-10 |
| Parity | Parity=None | Wincor/Nixdorf: Parity=Odd | 3-10 |
| Hardware Flow Control | Disable | Wincor/Nixdorf: CTS Flow Control | 3-11 |
| Intercharacter Delay | No Delay | | 3-12 |
| Software Flow Control | Disable | | 3-13 |
| Host Echo | Disable | | 3-14 |
| Host Echo Quiet Interval | 10 msec | | 3-15 |
| Signal Voltage: Normal/TTL | Normal RS-232 | | 3-16 |
| RS-232 Invert | Disable | | 3-17 |
| Beep on ASCII BEL | Enable | | 3-17 |
| Beep on Not on File | Enable | | 3-18 |
| ACK NAK Options | Disable | | 3-19 |
| ACK Character | ACK | | 3-20 |
| NAK Character | ! | | 3-20 |
| Retry on ACK NAK Timeout | Enable | | 3-21 |
| ACK NAK Timeout Value | 200 msec | | 3-21 |
| ACK NAK Retry Count | 3 | | 3-22 |
| ACK NAK Error Handling | Ignore Errors Detected | | 3-23 |
| Transmission Failure Indication | Enable | | 3-24 |
| IBM-USB Device usage | — | IBM-USB: Configure as Handheld Scanner | 3-24 |

| Feature | Std. RS-232 Setting | Interface-Specific Exceptions | Page # |
|---|---------------------|--------------------------------------|--------|
| IBM Transmit Labels in Code 39 Format | — | IBM: Disable | 3-25 |
| Wand Emulation: Bar/Space Polarity | — | Wand Emulation: Bar/Space = High/Low | 3-27 |
| Wand Emulation: Wand Idle State | — | Wand Emulation: Low | 3-27 |
| Wand Emulation: Signal Speed | — | Wand Emulation: 660 msec | 3-28 |
| Wand Emulation: Transmit Leading Noise | — | Wand Emulation: Enable | 3-29 |
| Wand Emulation: Transmit Trailing Noise | — | Wand Emulation: Enable | 3-28 |
| Wand Emulation: Symbology Conversion | — | Wand Emulation: No Conversion | 3-29 |
| Keyboard Wedge/USB Keyboard: Keyboard Layout | — | KBW/USB KB: USA | 3-30 |
| Keyboard Wedge/USB Keyboard: Caps Lock State | — | KBW/USB KB: Disable | 3-32 |
| Keyboard Wedge/USB Keyboard: Power-On Simulation | — | KBW/USB KB: Disable | 3-33 |
| Keyboard Wedge/USB Keyboard: Control Characters | — | KBW/USB KB: Disable | 3-34 |
| Keyboard Wedge/USB Keyboard: Wedge Quiet Interval | — | KBW/USB KB: 100 msec | 3-35 |
| Keyboard Wedge/USB Keyboard: Intercharacter Delay | — | KBW/USB KB: No Delay | 3-36 |
| Global Prefix | None | | 4-2 |
| Global Suffix | CR | IBM: No Suffix | 4-2 |
| AIM ID | Disable | | 4-4 |

| Feature | Std. RS-232 Setting | Interface-Specific Exceptions | Page # |
|------------------------------|--|--|--------|
| Label ID | Label ID Position: Before Bar Code Data | IBM: Disable Keyboard Wedge: Disable | 4-5 |
| UPC-A Label ID | A | | 4-6 |
| UPC-A w/P2 Addon Label ID | A | | 4-6 |
| UPC-A w/P5 Addon Label ID | A | | 4-6 |
| UPC-A w/C128 Addon Label ID | A | | 4-6 |
| UPC-E Label ID | E | Wincor/Nixdorf: 'C' | 4-6 |
| UPC-E w/P2 Addon Label ID | E | | 4-7 |
| UPC-E w/P5 Addon Label ID | E | | 4-7 |
| UPC-E w/C128 Addon Label ID | E | | 4-7 |
| EAN-8 Label ID | FF | Wincor/Nixdorf: 'B' | 4-7 |
| EAN-8 w/P2 Addon Label ID | FF | | 4-7 |
| EAN-8 w/P5 Addon Label ID | FF | | 4-7 |
| EAN-8 w/C128 Addon Label ID | FF | | 4-7 |
| EAN-13 Label ID | F | Wincor/Nixdorf: 'F' | 4-7 |
| EAN-13 w/P2 Addon Label ID | F | | 4-8 |
| EAN-13 w/P5 Addon Label ID | F | | 4-8 |
| EAN-13 w/C128 Addon Label ID | F | | 4-8 |
| ISBN Label ID | I | Wincor/Nixdorf: 'A' | 4-8 |
| GTIN Label ID | G | | 4-8 |
| GTIN w/P2 addon Label ID | G2 | | 4-8 |

| Feature | Std. RS-232 Setting | Interface-Specific Exceptions | Page # |
|--------------------------------|------------------------|-------------------------------|--------|
| GTIN w/P5 addon Label ID | G5 | | 4-8 |
| GTIN w/C128 addon Label ID | G6 | | 4-9 |
| RSS-14 Label ID | R4 | Wincor/Nixdorf: 'E' | 4-9 |
| RSS Expanded Label ID | RX | Wincor/Nixdorf: 'E' | 4-9 |
| Code 39 Label ID | * | | 4-9 |
| Pharmacode 39 Label ID | A | | 4-9 |
| Code 128 Label ID | # | Wincor/Nixdorf: 'K' | 4-9 |
| I 2 of 5 Label ID | i | Wincor/Nixdorf: 'I' | 4-9 |
| Codabar Label ID | % | Wincor/Nixdorf: 'N' | 4-10 |
| Code 93 Label ID | & | Wincor/Nixdorf: 'L' | 4-10 |
| MSI/Plessey Label ID | @ | Wincor/Nixdorf: 'O' | 4-10 |
| Std 2 of 5 Label ID | i | Wincor/Nixdorf: 'H' | 4-10 |
| PDF 417 Label ID | P | Wincor/Nixdorf: 'Q' | 4-10 |
| Case Conversion | Disable | | 4-11 |
| Character Conversion | No Conversion | | 4-12 |
| Disable/Enable UPC-A | Enable | | 5-1 |
| UPC-A Check Digit Transmission | Send Check Digit | | 5-2 |
| Expand UPC-A to EAN-13 | Don't Expand to EAN-13 | | 5-2 |
| System Number Transmission | Enable | | 5-3 |
| UPC-A Minimum Reads | 1 | | 5-3 |

| Feature | Std. RS-232 Setting | Interface-Specific Exceptions | Page # |
|---------------------------------|-----------------------|-------------------------------|--------|
| In-store Minimum Reads | 1 | | 5-4 |
| Disable/Enable UPC-E | Enable | | 5-5 |
| Check Digit Transmission | Send Check Digit | | 5-5 |
| Number System Digit | Exclude System Number | | 5-6 |
| Expand to UPC-E to UPC-A | Don't Expand | | 5-6 |
| Expand UPC-E to EAN13 | Don't Expand | | 5-7 |
| UPC-E Minimum Reads | 2 | | 5-7 |
| Disable/Enable GTIN | Disable | | 5-8 |
| Expand UPC/EAN to GTIN | Don't Expand | | 5-8 |
| Disable/Enable EAN-13 | Enable | | 5-9 |
| EAN-13 Check Digit Transmission | Send Check Digit | | 5-9 |
| EAN-13 Flag 1 Character | Transmit | | 5-10 |
| ISBN | Disable | | 5-10 |
| EAN-13 Minimum Reads | 1 | | 5-11 |
| Disable/Enable EAN-8 | Enable | | 5-12 |
| EAN-8 Check Digit Transmission | Send Check Digit | | 5-12 |
| Expand EAN-8 to EAN-13 | Don't Expand | | 5-13 |
| EAN-8 Minimum Reads | 1 | | 5-13 |
| Enable EAN Two-Label | Disable | | 5-14 |
| Enable EAN Two-Label Combined | Disable | | 5-14 |
| Optional 2-Digit Addons | Disable | | 5-16 |

| Feature | Std. RS-232 Setting | Interface-Specific Exceptions | Page # |
|-------------------------------------|---------------------|-------------------------------|--------|
| Optional 5-Digit Addons | Disable | | 5-16 |
| Optional Code 128 Add-ons | Disable | | 5-16 |
| Disable/Enable RSS-14 | Disable | | 5-17 |
| RSS-14 UCC/EAN 128 Emulation | Disable | | 5-17 |
| RSS-14 Minimum Reads | 1 | | 5-18 |
| Disable/Enable RSS Expanded | Disable | | 5-20 |
| RSS Expanded UCC/EAN 128 Emulation | Disable | | 5-20 |
| RSS Expanded Length Control | Variable Length | | 5-21 |
| RSS Expanded Length 1 | 1 | | 5-22 |
| RSS Expanded Length 2 | 74 | | 5-22 |
| RSS Expanded Minimum Reads | 1 | | 5-23 |
| Disable/Enable Code 39 | Enable | | 5-27 |
| Code 39 Check Character Calculation | Disable | | 5-27 |
| Code 39 Check Character Transmit | Enable | | 5-28 |
| Code 39 Start/Stop Characters | Don't Transmit | | 5-28 |
| Code 39 Full ASCII | Disable | | 5-29 |
| Code 39 Length Control | Variable Length | | 5-30 |
| Code 39 Length 1 | 3 | | 5-31 |
| Code 39 Length 2 | 50 | | 5-31 |
| Code 39 Quiet Zones | Don't Require | | 5-31 |
| Code 39 Stitching | Disable | | 5-32 |

| Feature | Std. RS-232 Setting | Interface-Specific Exceptions | Page # |
|---|---------------------|-------------------------------|--------|
| Code 39 Minimum Reads | 1 | | 5-32 |
| Disable/Enable Pharmacode 39 | Disable | | 5-33 |
| Pharmacode 39 Start/Stop Characters | Don't Transmit | | 5-33 |
| Pharmacode 39 Check Character Transmit | Enable | | 5-34 |
| Disable/Enable Code 128 | Enable | | 5-35 |
| Transmit UCC/EAN128 labels in EAN 128 data format | Disable | | 5-35 |
| Code 128 Transmit Function Characters | Don't Transmit | | 5-36 |
| Code 128 Length Control | Variable Length | | 5-37 |
| Code 128 Length 1 | 1 | | 5-38 |
| Code 128 Length 2 | 80 | | 5-38 |
| Code 128 Conversion to Code 39 | Disable | | 5-38 |
| Code 128 Stitching | Disable | | 5-39 |
| Code 128 Minimum Reads | 1 | | 5-39 |
| Disable/Enable Interleaved 2 of 5 | Disable | | 5-40 |
| I 2 of 5 Check Digit Calculation | Disable | | 5-40 |
| I 2 of 5 Check Digit Transmit | Enable | | 5-47 |
| I 2 of 5 Length Control | Variable Length | | 5-42 |
| I 2 of 5 Length 1 | 6 | | 5-43 |
| I 2 of 5 Length 2 | 50 | | 5-43 |
| Interleaved 2 of 5 Stitching | Disable | | 5-44 |
| I 2 of 5 Minimum Reads | 1 | | 5-45 |

| Feature | Std. RS-232 Setting | Interface-Specific Exceptions | Page # |
|---|----------------------------|-------------------------------|--------|
| Disable/Enable Codabar | Disable | | 5-46 |
| Codabar Check Character Verification | Disable | | 5-46 |
| Codabar Check Character Transmit | Enable | | 5-47 |
| Codabar Length Control | Variable Length | | 5-48 |
| Codabar Length 1 | 3 | | 5-49 |
| Codabar Length 2 | 50 | | 5-49 |
| Codabar Quiet Zones | Don't Require | | 5-49 |
| Codabar Start/Stop Character Type | Start/Stop Type: abcd/abcd | | 5-50 |
| Codabar Start/Stop Character Transmission | Enable | | 5-50 |
| Codabar Start/Stop Character Match | Disable | | 5-51 |
| Codabar Stitching | Disable | | 5-51 |
| Codabar Minimum Reads | 1 | | 5-52 |
| Disable/Enable Code 93 | Disable | | 5-53 |
| Code 93 Length Control | Variable Length | | 5-54 |
| Code 93 Length 1 | 1 | | 5-55 |
| Code 93 Length 2 | 50 | | 5-55 |
| Code 93 Stitching | Disable | | 5-56 |
| Code 93 Minimum Reads | 1 | | 5-56 |
| Disable/Enable MSI/Plessey | Disable | | 5-57 |
| MSI/Plessey Check Digit Verification | Disable | | 5-57 |
| MSI/Plessey Check Digit Transmit | 1-Digit | | 5-58 |

| Feature | Std. RS-232 Setting | Interface-Specific Exceptions | Page # |
|-------------------------------------|---------------------|-------------------------------|--------|
| Number of Check Characters | 1 Check Character | | 5-58 |
| MSI/Plessey Length Control | Variable Length | | 5-65 |
| MSI/Plessey Length 1 | 4 | | 5-60 |
| MSI/Plessey Length 2 | 16 | | 5-60 |
| MSI/Plessey Stitching | Disable | | 5-61 |
| MSI/Plessey Minimum Reads | 1 | | 5-62 |
| Disable/Enable Standard 2 of 5 | Disable | | 5-63 |
| Std 2 of 5 Check Digit Verification | Disable | | 5-63 |
| Std 2 of 5 Check Digit Transmit | Enable | | 5-64 |
| Std 2 of 5 Length Control | Variable Length | | 5-65 |
| Std 2 of 5 Length 1 | 8 | | 5-66 |
| Std 2 of 5 Length 2 | 50 | | 5-66 |
| Standard 2 of 5 Stitching | Disable | | 5-67 |
| Std 2 of 5 Minimum Reads | 1 | | 5-68 |
| Disable/Enable PDF417 | Disable | | 5-69 |
| PDF417 Length Control | Variable Length | | 5-70 |
| PDF417 Length 1 | 1 | | 5-71 |
| PDF417 Length 2 | 600 | | 5-71 |
| PDF417 Minimum Reads | 1 | | 5-69 |

Appendix E

Keyboard Function Key Mappings

Keyboard Model Cross Reference

Table E-1 summarizes the keyboard models, their defined protocol, scancode set, and some unique features. The remaining tables in this chapter provide the function key maps associated with each of the scancode sets.

Table E-1. Keyboard Model Cross Reference

| Model Type | I/F ID | Transmission Protocol | Scancode Set | Func. Key Map Support | Use Country Mode |
|--|---------|-----------------------|-----------------|-----------------------|------------------|
| PC/XT Foreign ALT Mode | Wedge A | PC/XT | Scan Set 1 | No | No |
| AT; PS/2 25-286; PS/2 30-286; PS/2 50, 50Z; PS/2 60,70,80,90,95 Foreign ALT Mode | Wedge B | AT/PS2 | Scan Set 2 | No | No |
| PS/2 25 and 30 Foreign ALT Mode | Wedge C | AT/PS2 | Scan Set 1 | No | No |
| PC/XT U.S. Mode | Wedge D | PC/XT | Scan Set 1 | Yes | No |
| AT; PS/2 25-286; PS/2 30-286; PS/2 50, 50Z; PS/2 60,70,80,90,95 U.S. Mode + specific country support | Wedge E | AT/PS2 | Scan Set 2 | Yes | Yes |
| PS/2 25 and 30 U.S. Mode | Wedge F | AT/PS2 | Scan Set 1 | Yes | No |
| IBM 3xxx Terminals (122-key keyboard) | Wedge G | AT/PS2 | Scan Set 3 | Yes | No |
| IBM 3xxx Terminals (102-key keyboard) | Wedge H | AT/PS2 | Scan Set 3 | Yes | No |
| PS55 5530T with JAPANESE DOS (TDOS) | Wedge I | AT/PS2 | Japanese DOS | Yes | No |
| NEC 9801 | Wedge J | NEC 9801 | NEC 9801 | Yes | No |

Table E-2. Scanset 1 Function Key Map

| ASCII (hex) | ASCII code | Key | Scancode |
|-------------|------------|----------------------------|----------|
| 00 | NUL | ALT right Make | E0h 38h |
| 01 | SOH | ALT right Break | E0h B8h |
| 02 | STX | ALT left Make | 38h |
| 03 | ETX | ALT left Break | B8h |
| 04 | EOT | CTRL left Make | 1Dh |
| 05 | ENQ | CTRL left Break | 9Dh |
| 06 | ACK | CTRL right Make | E0h 1Dh |
| 07 | BEL | CTRL right Break | E0h 9Dh |
| 08 | BS | BS | 0Eh |
| 09 | HT | TAB right | 0Fh |
| 0A | LF | RIGHT arrow (inner keypad) | 4Dh + E0 |
| 0B | VT | TAB left | 0Fh + S |
| 0C | FF | Enter (inner keypad) | 1Ch + E0 |
| 0D | CR | CR | 1Ch |
| 0E | SO | INSERT (inner keypad) | 52h + E0 |
| 0F | SI | PAGE UP (inner keypad) | 49h + E0 |
| 10 | DLE | PAGE DOWN (inner keypad) | 51h + E0 |
| 11 | DC1 | HOME (inner keypad) | 47h + E0 |
| 12 | DC2 | LEFT arrow (inner keypad) | 4Bh + E0 |
| 13 | DC3 | DOWN arrow (inner keypad) | 50h + E0 |
| 14 | DC4 | UP arrow (inner keypad) | 48h + E0 |

Table E-3. Scanset 2 Function Key Map

| ASCII (hex) | ASCII code | Key | Scancode |
|-------------|------------|----------------------------|-------------|
| 00 | NUL | ALT right Make | E0h 11h |
| 01 | SOH | ALT right Break | E0h F0h 11h |
| 02 | STX | ALT left Make | 11h |
| 03 | ETX | ALT left Break | F0h 11h |
| 04 | EOT | CTRL left Make | 14h |
| 05 | ENQ | CTRL left Break | F0h 14h |
| 06 | ACK | CTRL right Make | E0h 14h |
| 07 | BEL | CTRL right Break | E0h F0h 14h |
| 08 | BS | BS | 66h |
| 09 | HT | TAB right | 0Dh |
| 0A | LF | RIGHT arrow (inner keypad) | 74h + E0 |
| 0B | VT | TAB left | 0Dh + S |
| 0C | FF | Enter (right keypad) | 5Ah + E0 |
| 0D | CR | CR | 5Ah |
| 0E | SO | INSERT (inner keypad) | 70h + E0 |
| 0F | SI | PAGE UP (inner keypad) | 7Dh + E0 |
| 10 | DLE | PAGE DOWN (inner keypad) | 7Ah + E0 |
| 11 | DC1 | HOME (inner keypad) | 6Ch + E0 |
| 12 | DC2 | LEFT arrow (inner keypad) | 6Bh + E0 |
| 13 | DC3 | DOWN arrow (inner keypad) | 72h + E0 |
| 14 | DC4 | UP arrow (inner keypad) | 75h + E0 |
| 15 | NAK | F6 | 0Bh |
| 16 | SYN | F1 | 05h |
| 17 | ETB | F2 | 06h |

| | | | |
|----|-----|-----|-----|
| 18 | CAN | F3 | 04h |
| 19 | EM | F4 | 0Ch |
| 1A | SUB | F5 | 03h |
| 1B | ESC | ESC | 76h |
| 1C | FS | F7 | 83h |
| 1D | GS | F8 | 0Ah |
| 1E | RS | F9 | 01h |
| 1F | US | F10 | 09h |

Table E-4. Scanset 3, 102-Key Function Key Map

| ASCII (hex) | ASCII code | Key | Scancode |
|-------------|------------|----------------------------|----------|
| 00 | NUL | ALT right Make | 39h |
| 01 | SOH | ALT right Break | F0h 39h |
| 02 | STX | ALT left Make | 19h |
| 03 | ETX | ALT left Break | F0h 19h |
| 04 | EOT | CTRL left Make | 11h |
| 05 | ENQ | CTRL left Break | F0h 11h |
| 06 | ACK | CTRL right Make | 58h |
| 07 | BEL | CTRL right Break | F0h 58h |
| 08 | BS | BS | 66h |
| 09 | HT | TAB right | 0Dh |
| 0A | LF | RIGHT arrow (inner keypad) | 6Ah |
| 0B | VT | TAB left | 0Dh + S |
| 0C | FF | Enter (inner keypad) | 79h |
| 0D | CR | CR | 5Ah |
| 0E | SO | INSERT (inner keypad) | 67h |
| 0F | SI | PAGE UP (inner keypad) | 6Fh |
| 10 | DLE | PAGE DOWN (inner keypad) | 6Dh |
| 11 | DC1 | HOME (inner keypad) | 6Eh |
| 12 | DC2 | LEFT arrow (inner keypad) | 61h |
| 13 | DC3 | DOWN arrow (inner keypad) | 60h |
| 14 | DC4 | UP arrow (inner keypad) | 63h |
| 15 | NAK | F6 | 2Fh |
| 16 | SYN | F1 | 07h |
| 17 | ETB | F2 | 0Fh |
| 18 | CAN | F3 | 17h |
| 19 | EM | F4 | 1Fh |
| 1A | SUB | F5 | 27h |
| 1B | ESC | ESC | 08h |
| 1C | FS | F7 | 37h |
| 1D | GS | F8 | 3Fh |
| 1E | RS | F9 | 47h |
| 1F | US | F10 | 4Fh |

Table E-5. Scanset 3 122-Key Function Key Map

| ASCII (hex) | ASCII code | Key | Scancode |
|-------------|------------|------------------------------|-------------|
| 00 | NUL | ALT Right Make | 39h |
| 01 | SOH | ALT Right Break | F0h 39h |
| 02 | STX | ALT left Make | 19h |
| 03 | ETX | ALT left Break | F0h 19h |
| 04 | EOT | CTRL left (RESET) Make only | 11h |
| 05 | ENQ | CTRL left (RESET) Make/Break | 11h F0h 11h |
| 06 | ACK | ONLINE Enter Make only | 58h |
| 07 | BEL | ONLINE Enter Make/Break | 58h F0h 58h |
| 08 | BS | BS | 66h |
| 09 | HT | TAB right | 0Dh |
| 0A | LF | RIGHT arrow (inner keypad) | 6Ah |
| 0B | VT | TAB left | 0Dh + S |
| 0C | FF | CR (FIELD EXIT) Make only | 5Ah F0h 5Ah |
| 0D | CR | CR (FIELD EXIT) Make/Break | 5Ah |
| 0E | SO | INSERT (inner keypad) | 65h |
| 0F | SI | FIELD + | 79h |
| 10 | DLE | FIELD - | 7Ch |
| 11 | DC1 | HOME (inner keypad) | 62h |
| 12 | DC2 | LEFT arrow (inner keypad) | 61h |
| 13 | DC3 | DOWN arrow (inner keypad) | 60h |
| 14 | DC4 | UP arrow (inner keypad) | 63h |
| 15 | NAK | F6 | 2Fh |
| 16 | SYN | F1 | 07h |
| 17 | ETB | F2 | 0Fh |
| 18 | CAN | F3 | 17h |
| 19 | EM | F4 | 1Fh |
| 1A | SUB | F5 | 27h |
| 1B | ESC | ESC | 08h |
| 1C | FS | F7 | 37h |
| 1D | GS | F8 | 3Fh |
| 1E | RS | F9 | 47h |
| 1F | US | F10 | 4Fh |

Table E-6. Japanese DOS Function Key Map

| ASCII value | ASCII code | Key | Scancode |
|-------------|------------|----------------------------|----------|
| 00h | NUL | ALT right Make | 31h |
| 01h | SOH | ALT right Break | B1h |
| 02h | STX | ALT left Make | 31h |
| 03h | ETX | ALT left Break | B1h |
| 04h | EOT | CTRL left Make | 41h |
| 05h | ENQ | CTRL left Break | C1h |
| 06h | ACK | CTRL right Make | 41h |
| 07h | BEL | CTRL right Break | C1h |
| 08h | BS | BS | 3Eh |
| 09h | HT | TAB right | 3Ch |
| 0Ah | LF | RIGHT arrow (inner keypad) | 4Dh |
| 0Bh | VT | TAB left | 3Ch + S |
| 0Ch | FF | Enter (right keypad) | 60h |
| 0Dh | CR | CR | 3Bh |
| 0Eh | SO | INSERT (inner keypad) | 52h |
| 0Fh | SI | PAGE UP (inner keypad) | 49h |
| 10h | DLE | PAGE DOWN (inner keypad) | 51h |
| 11h | DC1 | HOME (inner keypad) | 4Ch |
| 12h | DC2 | LEFT arrow (inner keypad) | 4Bh |
| 13h | DC3 | DOWN arrow (inner keypad) | 4Ah |
| 14h | DC4 | UP arrow (inner keypad) | 4Eh |
| 15h | NAK | F6 | 6Dh |
| 16h | SYN | F1 | 68h |
| 17h | ETB | F2 | 69h |
| 18h | CAN | F3 | 6Ah |
| 19h | EM | F4 | 6Bh |
| 1Ah | SUB | F5 | 6Ch |
| 1Bh | ESC | ESC | 3Dh |
| 1Ch | FS | F7 | 6Eh |
| 1Dh | GS | F8 | 6Fh |
| 1Eh | RS | F9 | 70h |
| 1Fh | US | F10 | 71h |

Table E-7. NEC 9801-Key Function Key Map

| ASCII value | ASCII code | Key | Scancode |
|-------------|------------|----------------------------|----------|
| 00h | NUL | unused | n/a |
| 01h | SOH | CR | 1Ch |
| 02h | STX | CAPS LOCK ON (make) | 71h |
| 03h | ETX | CAPS LOCK OFF (break) | F1h |
| 04h | EOT | CTRL left Make | 74h |
| 05h | ENQ | CTRL left Break | F4h |
| 06h | ACK | CTRL-C | 60h |
| 07h | BEL | n/a | n/a |
| 08h | BS | BS | 0Eh |
| 09h | HT | TAB right | 0Fh |
| 0Ah | LF | RIGHT arrow (inner keypad) | 3Ch |
| 0Bh | VT | TAB left | 0Fh + S |
| 0Ch | FF | DELETE | 39h |
| 0Dh | CR | CR | 1Ch |
| 0Eh | SO | INSERT (inner keypad) | 38h |
| 0Fh | SI | KATAKANA LOCK ON (Make) | 72h |
| 10h | DLE | KATAKANA LOCK OFF (Break) | F2h |
| 11h | DC1 | HOME (inner keypad) | 3Eh |
| 12h | DC2 | LEFT arrow (inner keypad) | 3Bh |
| 13h | DC3 | DOWN arrow (inner keypad) | 3Dh |
| 14h | DC4 | UP arrow (inner keypad) | 3Ah |
| 15h | NAK | F6 | 67h |
| 16h | SYN | F1 | 62h |
| 17h | ETB | F2 | 63h |
| 18h | CAN | F3 | 64h |
| 19h | EM | F4 | 65h |
| 1Ah | SUB | F5 | 66h |
| 1Bh | ESC | ESC | 00h |
| 1Ch | FS | F7 | 68h |
| 1Dh | GS | F8 | 69h |
| 1Eh | RS | F9 | 6Ah |
| 1Fh | US | F10 | 6Bh |

Chapter F

Host Commands

Accepting RS-232 Commands

The scanner responds to the following RS-232 commands:

| COMMAND | ASCII | HEX | COMMENT |
|------------------------|-------|------|------------------------------------|
| Enable Scanner | E | 0x45 | |
| Disable Scanner | D | 0x44 | |
| Reset Scanner | R | 0x52 | |
| Not On File Indication | F | 0x46 | Long series of beeps |
| Beep Good Read Tone | B | 0x42 | Beeps if Good Read Beep is enabled |
| Force Good Read Tone | | 0x01 | Beeps regardless of beep setting |
| Bel | | 0x07 | Force Good Read Tone |
| Identification request | i | 0x69 | Returns long response ^a |
| Health request | h | 0x68 | Returns long response ^a |
| Status request | s | 0x73 | Returns long response ^a |

a. Call Tech Support for information.

If one of the above commands is received, the scanner will perform the steps indicated for the command. Host commands for other interfaces are also available. Contact Tech Support for more details.

NOTES

Chapter G

Sample Symbols

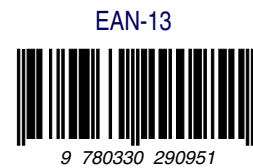
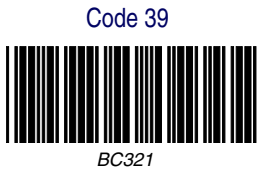

Sample Symbols

RSS-14



RSS Expanded



ASCII Chart

| ASCII Char. | Hex No. | ASCII Char. | Hex No. | ASCII Char. | Hex No. | ASCII Char. | Hex No. |
|-------------|---------|-------------|---------|-------------|---------|-------------|---------|
| NUL | 00 | SP | 20 | @ | 40 | ' | 60 |
| SOH | 01 | ! | 21 | A | 41 | a | 61 |
| STX | 02 | " | 22 | B | 42 | b | 62 |
| ETX | 03 | # | 23 | C | 43 | c | 63 |
| EOT | 04 | \$ | 24 | D | 44 | d | 64 |
| ENQ | 05 | % | 25 | E | 45 | e | 65 |
| ACK | 06 | & | 26 | F | 46 | f | 66 |
| BEL | 07 | ' | 27 | G | 47 | g | 67 |
| BS | 08 | (| 28 | H | 48 | h | 68 |
| HT | 09 |) | 29 | I | 49 | i | 69 |
| LF | 0A | * | 2A | J | 4A | j | 6A |
| VT | 0B | + | 2B | K | 4B | k | 6B |
| FF | 0C | , | 2C | L | 4C | l | 6C |
| CR | 0D | - | 2D | M | 4D | m | 6D |
| SO | 0E | . | 2E | N | 4E | n | 6E |
| SI | 0F | / | 2F | O | 4F | o | 6F |
| DLE | 10 | 0 | 30 | P | 50 | p | 70 |
| DC1 | 11 | 1 | 31 | Q | 51 | q | 71 |
| DC2 | 12 | 2 | 32 | R | 52 | r | 72 |
| DC3 | 13 | 3 | 33 | S | 53 | s | 73 |
| DC4 | 14 | 4 | 34 | T | 54 | t | 74 |
| NAK | 15 | 5 | 35 | U | 55 | u | 75 |
| SYN | 16 | 6 | 36 | V | 56 | v | 76 |
| ETB | 17 | 7 | 37 | W | 57 | w | 77 |
| CAN | 18 | 8 | 38 | X | 58 | x | 78 |
| EM | 19 | 9 | 39 | Y | 59 | y | 79 |
| SUB | 1A | : | 3A | Z | 5A | z | 7A |
| ESC | 1B | ; | 3B | [| 5B | { | 7B |
| FS | 1C | < | 3C | \ | 5C | | 7C |
| GS | 1D | = | 3D |] | 5D | } | 7D |
| RS | 1E | > | 3E | ^ | 5E | ~ | 7E |
| US | 1F | ? | 3F | _ | 5F | DEL | 7F |

Australia

Datalogic Scanning Pty Ltd
North Ryde, Australia
Telephone: [61] (2) 9870 3200
Fax: [61] (2) 9878 8688

France and Benelux

Datalogic Scanning Sarl
LES ULIS Cedex, France
Telephone: [33].01.64.86.71.00
Fax: [33].01.64 46.72.44

Germany

Datalogic Scanning GmbH
Darmstadt, Germany
Telephone: 49 (0) 61 51/93 58-0
Fax: 49 (0) 61 51/93 58 58

Italy

Datalogic Scanning SpA
Vimercate (MI), Italy
Telephone: [39] (0) 39/62903.1
Fax: [39] (0) 39/6859496

Japan

Datalogic Scanning KK
Shinagawa, Tokyo, Japan
Telephone: 81 (0)3 3491 6761
Fax: 81 (0)3 3491 6656

Latin America

Datalogic Scanning, Inc
Miami, Florida, USA
Telephone: (305) 591-3222
Fax: (305) 591-3007

Spain and Portugal

Datalogic Scanning Sarl Sucursal en España
Madrid, Spain
Telephone: 34 91 746 28 60
Fax: 34 91 742 35 33

United Kingdom

Datalogic Scanning LTD
Watford, England
Telephone: 44 (0) 1923 809500
Fax: 44 (0) 1923 809 505



www.scanning.datalogic.com

Datalogic Scanning, Inc.

959 Terry Street
Eugene, OR 97402
Telephone: (541) 683-5700
Fax: (541) 345-7140



Free Manuals Download Website

<http://myh66.com>

<http://usermanuals.us>

<http://www.somanuals.com>

<http://www.4manuals.cc>

<http://www.manual-lib.com>

<http://www.404manual.com>

<http://www.luxmanual.com>

<http://aubethermostatmanual.com>

Golf course search by state

<http://golfingnear.com>

Email search by domain

<http://emailbydomain.com>

Auto manuals search

<http://auto.somanuals.com>

TV manuals search

<http://tv.somanuals.com>