

M-4206 Operator's Manual



CLASS™

DATAMAX®

Copyright Information:

CG Triumvirate is a trademark of Agfa Corporation.

CG Times based upon Times New Roman under license from the Monotype Corporation.

Windows is a registered trademark of the Microsoft Corporation.

All other brand and product names are trademarks, service marks, registered trademarks, or registered service marks of their respective companies.

Firmware (Software) Agreement

The enclosed Firmware (Software) resident in the Printer is owned by Licensor or its suppliers and is licensed for used only on a single printer in the user's Trade or Business. **The User agrees not to, and not to authorize or permit any other person or party to, duplicate or copy the Firmware or the information contained in the non-volatile or programmable memory.** The firmware (Software) is protected by applicable copyright laws and Licensor retains all rights not expressly granted. In no event will Licensor or its suppliers be liable for any damages or loss, including direct, incidental, economic, special, or consequential damages, arising out of the use or inability to use the Firmware (Software).

Information in this document is subject to change without notice and does not represent a commitment on the part of Datamax Barcode Products Corporation. No part of this manual may be reproduced or transmitted in any form or by any means, for any purpose other than the purchaser's personal use, without the expressed written permission of Datamax Corporation.

All rights reserved. Printed in the United States of America.

© Copyright 2002 by Datamax Corporation

Part Number: 88-2300-01

Revision: B

Agency Compliance and Approvals:



UL60950 Information Technology Equipment
C22.2 No. 950-M93



EN60950

For 230 Volt Operation (Europe): Use a cord set, marked "HAR," consisting of a min H05VV-F cord which has a minimum 0.75 square mm diameter conductors, provided with an IEC 320 receptacle and a male plug for the country of installation rated 6A, 250V

Für 230 Volt (Europa): Benützen Sie ein Kabel, das mit "HAR" markiert ist, bestehend mindestens aus einem H05VV-F Kabel, das mindestens 0,75 Quadratmillimeter Drahtdurchmesser hat; sowie eine IEC320 Steckdose und einen für das Land geeigneten Stecker, 6A, 250 Volt.



As an Energy Star Partner, the manufacturer has determined that this product meets the Energy Star guidelines for energy efficiency.



The manufacturer declares under sole responsibility that this product conforms to the following standards or other normative documents:

EMC: EN 55022 (1993) Class B
EN 50024 (1998)



Safety: This product complies with the requirements of EN 60950 /A11:1997

Gost-R

FCC: This device complies with FCC CFR 47 Part 15 Class A.

Note: This equipment has been tested and found to comply with the limits for a Class A digital device, pursuant to Part 15 of the FCC Rules. These limits are designed to provide reasonable protection against harmful interference when the equipment is operated in a commercial environment. This equipment generates, uses, and can radiate radio frequency energy, and if not installed and used in accordance with the instructions in this manual, it may cause harmful interference to radio communications. Operation of this equipment in a residential area is likely to cause harmful interference in which case the user will be required to correct the interference at his own expense.

Important Safety Instructions

This printer has been carefully designed to provide many years of safe, reliable performance. As with all electrical equipment, there are a few basic precautions you should take to avoid hurting yourself or damaging the printer:

Carefully read the installation and operating instructions provided with your printer.

Read and follow all warning instruction labels on the printer.

Place the printer on a flat, firm, solid surface.

To protect your printer from overheating, make sure all openings on the printer are not blocked.

Do not place the printer on or near a heat source.

Do not use your printer near water, or spill liquid into it.

Be certain that your power source matches the rating listed on your printer. If you are unsure, check with your dealer or with your local power company.

Do not place the power cord where it will be walked on. If the power cord becomes damaged or frayed replace it immediately.

Do not insert anything into the ventilation slots or openings on the printer.

Only qualified, trained service technicians should attempt to repair your printer.

Contents

Printer Overview

1.0	Introduction.....	1
1.1	About this Printer	2
1.1.1	Standard Features.....	2
1.1.2	Optional Features.....	3

Getting Started

2.0	Before Using the Printer	5
-----	--------------------------------	---

Setting Up the Printer

3.0	Introduction.....	7
3.1	Connecting the Printer	7
3.1.1	Power Connection	7
3.1.2	Interface Connection.....	8
3.2	Loading Media	9
3.3	Media Sensor Adjustment	12
3.4	Loading Ribbon	13
3.4.1	Ribbon Routing.....	15

Using the Front Panel

4.0	Introduction.....	16
4.1	Lights.....	16
4.2	Buttons	17
4.3	Normal Mode - Button Functions	17
4.4	Express Setup Mode - Button Functions	18
4.5	Printer Setup Mode - Button Functions	19
4.5.1	Printer Setup Menu List	20
4.5.2	Menu Items and Values	21
4.5.3	Step by Step Modification of the Printer Setup	24
4.6	Label Alignment	26
4.6.1	Label Alignment = YES.....	26
4.6.2	Label Alignment = AUTO.....	27
4.6.3	Label Alignment = NO	27
4.6.4	Label Alignment Troubleshooting.....	28

4.7	Calibration Mode – Button Functions	30
4.7.1	Auto Media Sensor Calibration	31
4.7.2	Manual Media Sensor Calibration	32
4.8	Internal Labels	33
4.8.1	Database Configuration and Dot Check Labels	33
4.8.2	Test Label	35
4.8.3	Hex Dump Label	36

Maintenance and Adjustments

5.0	Introduction	37
5.1	Cleaning the Printhead	38
5.2	Media Width Adjustment	39
5.3	Printhead Burn Line Adjustment	40
5.4	Printhead Pressure Adjustment	41
5.5	Printhead Replacement	42
5.6	Darkness Adjustment	43
5.7	Resetting to the Factory Defaults	43
5.8	Downloading Firmware and Fonts	44

Troubleshooting

6.0	Introduction	45
6.1	Troubleshooting Tips	45

Specifications

51

Appendix A

ASCII Control Code Chart	53
--------------------------------	----

Appendix B

Embedded Fonts and Barcodes	55
-----------------------------------	----

Appendix C

Warranty Information	65
----------------------------	----

Glossary

67



Printer Overview

1.0 Introduction



The M-4206 (hereafter referred to as ‘the printer’) is a user-friendly printer that blends quality and durability into an affordable package. The printer, available in direct and optional thermal transfer configurations, uses a unique front panel design to simplify operation, while its USB, RS232 serial, and IEEE 1284 compliant parallel interfaces allow easy connection to your host system.

This manual provides all the information necessary to operate the printer.

To print labels or tags simply refer to the instructions included with the software you have chosen to create the labels. A Windows printer driver can be found on our website (www.datamaxcorp.com) or on the included CD-ROM. If you wish to write a custom program, a copy of the *M-4206 Programmer’s Manual* (part number 88-2301-01) can also be found on the CD-ROM.

1.1 About this Printer

This printer offers the following standard and optional features:

1.1.1 Standard Features

Printing

- Direct Thermal Printing
- On Demand and Batch Printing
- 203 DPI Printhead
- AGFA Scalable Font Engine
- Date and Time Stamp

Memory

- 2 MB FLASH Memory
(256K available to user, designated: Module B)
- 4 MB DRAM Memory

Interfaces

- USB interface
- DB-9 RS-232 serial interface
- IEEE 1284 Centronics parallel interface

Operational

- Simple Media Loading
- Media Tearbar
- Fan-fold media compatible from the bottom and rear of printer

1.1.2 Optional Features

Thermal Transfer

A printing method that uses ribbon to produce exceptional image clarity, as compared to most direct thermal media types. This option must be specified for use with either 'coated side in' ribbon or 'coated side out' ribbon.

Media Cutter

A rotary-type mechanism to automatically cut material with a maximum thickness of .010" (.254 mm) into minimum lengths of 1.25 inches (31.8 mm).

Peel and Present Mechanism (requires the Internal Rewind option)

An output control device that automatically separates printed labels from the backing material and allows subsequent printing to occur only after the removal of a previously printed label. Minimum label length is 1.5 inches (38 mm).

Internal Rewind

An internal mechanism to wind four-inch outer diameter rolls of printed labels, or the label backing material when using the Peel and Present option.

Present Sensor

An output control device that allows subsequent printing to occur only after the removal of a previously printed label.

External Keyboard (specify voltage / country requirement when ordering)

A portable keyboard / display terminal, the DMX Passport™, for stand-alone printing.

External Ethernet Connectivity (uses printer's parallel port)

The DMX100 External Print Server is an external Network Interface Controller (NIC) that enables the printer to provide Ethernet connectivity.

FLASH Memory Expansion (requires new main PCB)

An optional main PCB assembly is available with 4MB Flash memory expansion for International Language Printing Capability (ILPC) and/or additional fonts and graphics.

ILPC

The International Language Print Capability consisting of one of the following:

- CG-Times (western European) Scalable font
- Kanji Gothic B Scalable font
- Simplified Chinese GB Scalable font
- Korean Hangul font



Getting Started

2.0 Before Using the Printer

Removing the Packaging

Inspect the shipping container(s) for damage; if damage is evident notify the shipping company to report the nature and extent of the damage.

The printer is carefully packaged to avoid any damage during transit. In order to operate the printer you will need to remove the packaging materials (i.e., tape and foam) that were placed in the printer for shipment. Complete the following steps prior to connecting power or attempting to load media.

- Ensure that the arrow on the box is pointing up, and then open the box.

- Remove the top piece of packing foam.

- Lift the printer from the box.

- Remove the printer from the plastic bag.

- Remove any tape or additional packing foam from the inside of the printer.

Note: It is a good idea to save all packaging materials in the event that shipping the printer is ever required.

Inspecting the Printer

After removing the printer from the packaging material, check the contents. The following items should be included:

- Printer
- Power Cord
- CD-ROM and Documentation
- Any special or additionally purchased items.



Additional Requirements

The following items are necessary for generating labels from your printer. Contact your customer support or sales representative for advice on which media and software may best be suited for your application.

- Serial, USB or Parallel cable
- Applicable Media
- Applicable Software



Setting Up the Printer

3.0 Introduction

This chapter explains how to connect your printer, load media (and ribbon, if equipped for thermal transfer), and print a configuration label.

3.1 Connecting the Printer

3.1.1 Power Connection

Note: When connecting the AC Power Cord or interface cables to the printer, ensure the Power On/Off Switch is in the 'Off' position.

1. Place the printer on a firm, level surface.
2. Ensure that the Power Switch on the Printer is in the 'Off' position.
3. Connect the AC Power Cord to the receptacle on the back of the Printer, and then plug the AC Power Cord into a properly grounded outlet. (The power supply automatically detects and then adjusts to the applied line voltage; see Section 7.0 for the acceptable voltage ranges.)

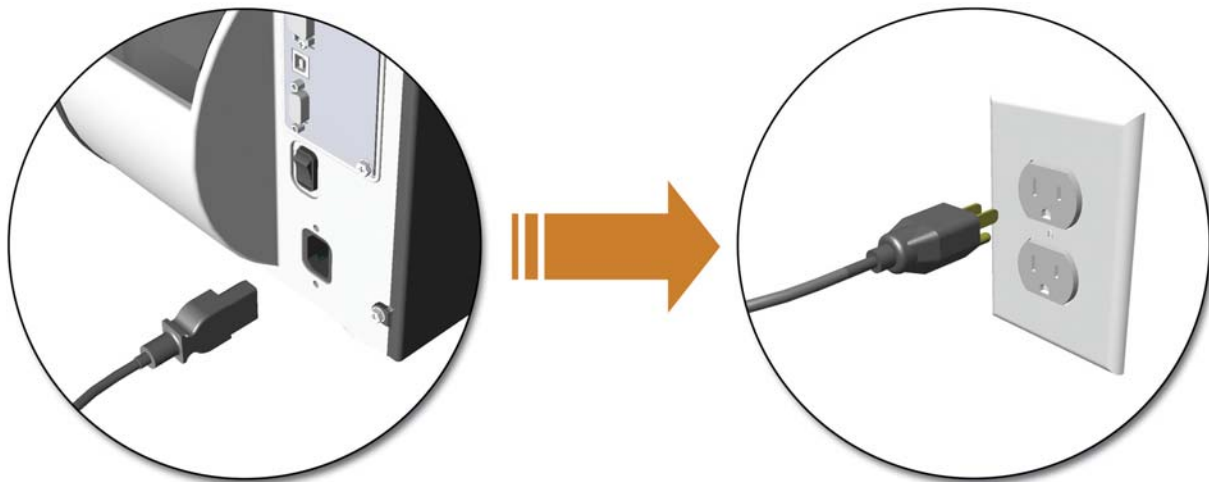

3.1.2 Interface Connection

The printer can be connected to the host via a USB, serial or parallel cable. The Printer will automatically connect to the first port (USB, serial or parallel) that transmits valid data. After this connection has been made, the printer's power must be cycled 'Off' and 'On' to change the interface connection.

USB Connection:

The USB Interface is supported in Windows 95 and greater. Depending upon the operating system of your host computer, installation may differ slightly.

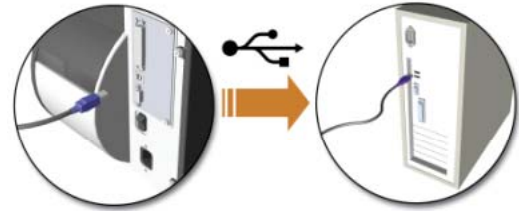

Parallel Connection:

The parallel interface requires a Centronics IEEE 1284 cable with a 36 pin male connector. Bi-directional mode is IEEE 1284 Compliant, using forward and reverse channel communications. In this mode, data can be sent to the host provided it is also IEEE 1284 Compliant and has supporting software.



Serial Connection:

The serial interface supports RS-232C communications via a DB-9 connector. The following list of serial port settings is menu-selectable and must match the host computer's serial port settings; see Chapter 4.

Baud Rate (Default 9600 bps)

Word Length (Default 8 bits)

In addition to the port settings, the serial interface cable wiring must have specific connections (pin-outs) for proper data exchange between the host and printer. The different serial cable pin-outs and part numbers are in the following table (contact your reseller for ordering information).

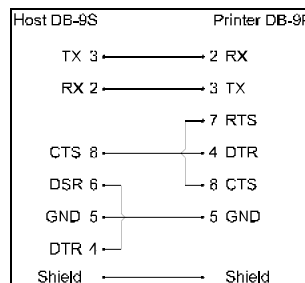
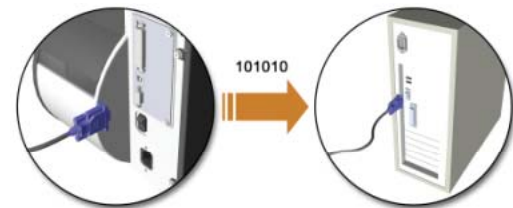

Part # 32-2300-01

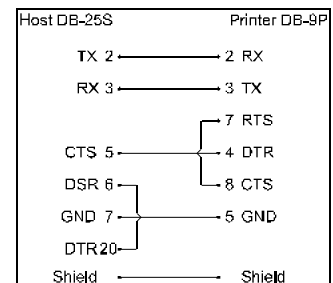

Part # 32-2301-01

3.2 Loading Media

Load media into the printer as follows:

1. Open the media cover and lower the Media Hub Guide and Media Guide.
2. Press in on the Printhead Latch and raise the Printhead Assembly.

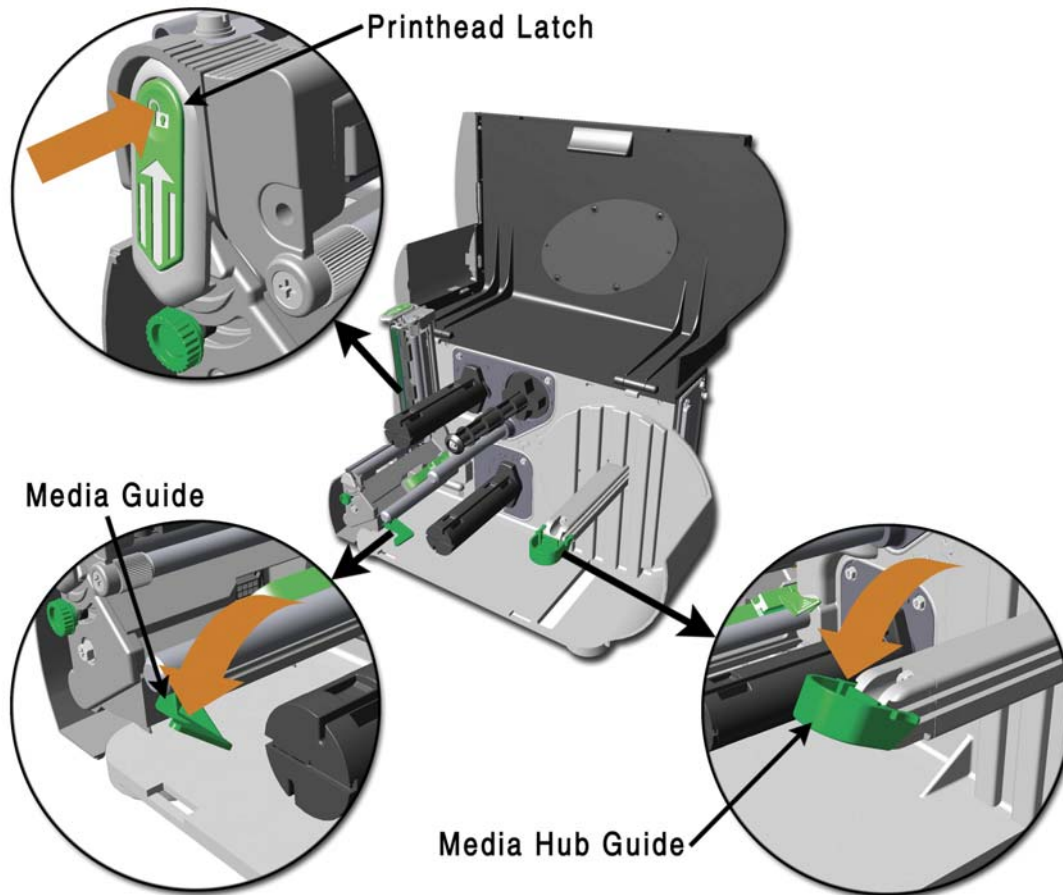

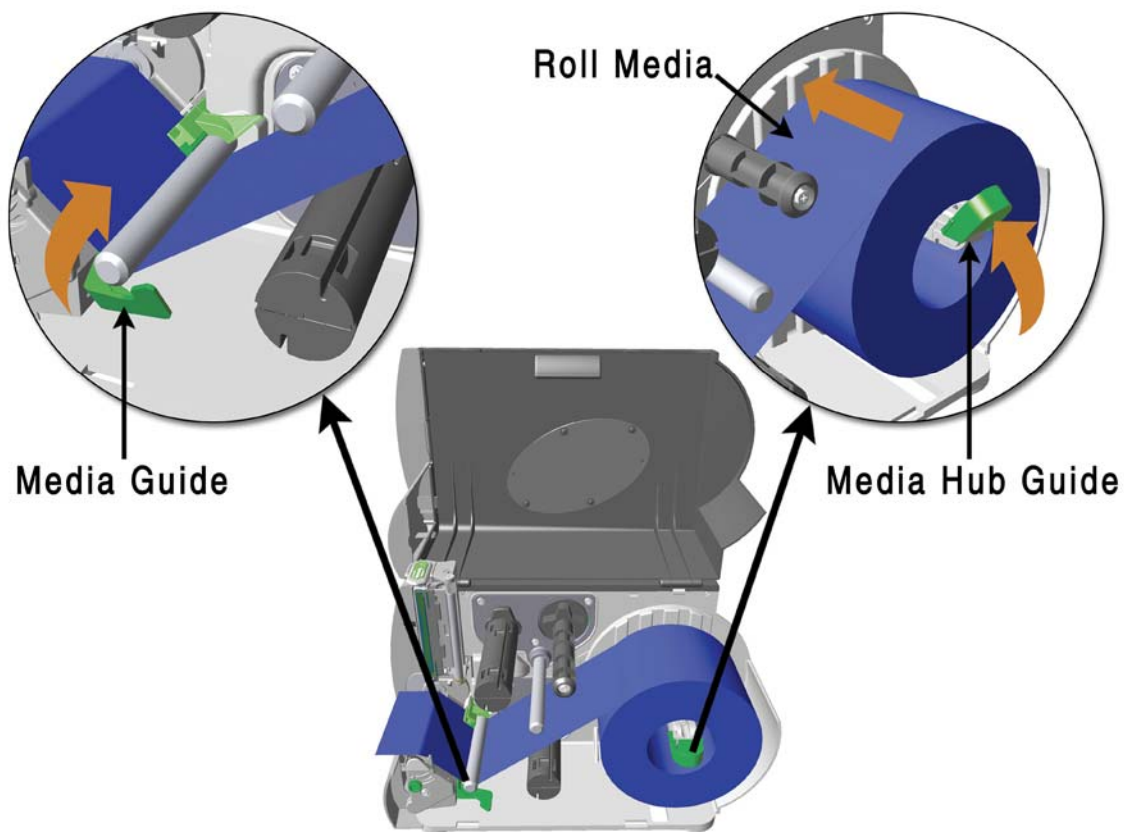

- Slide the Roll Media onto the Media Hub and raise the Media Hub Guide. The Media Hub Guide should be pushed inward so that it is just touching the Roll Media.
- Route the Media through the printer as shown. Raise the Media Guide. The Media Guide should be pushed inward so that it is just touching the edge of the Media.

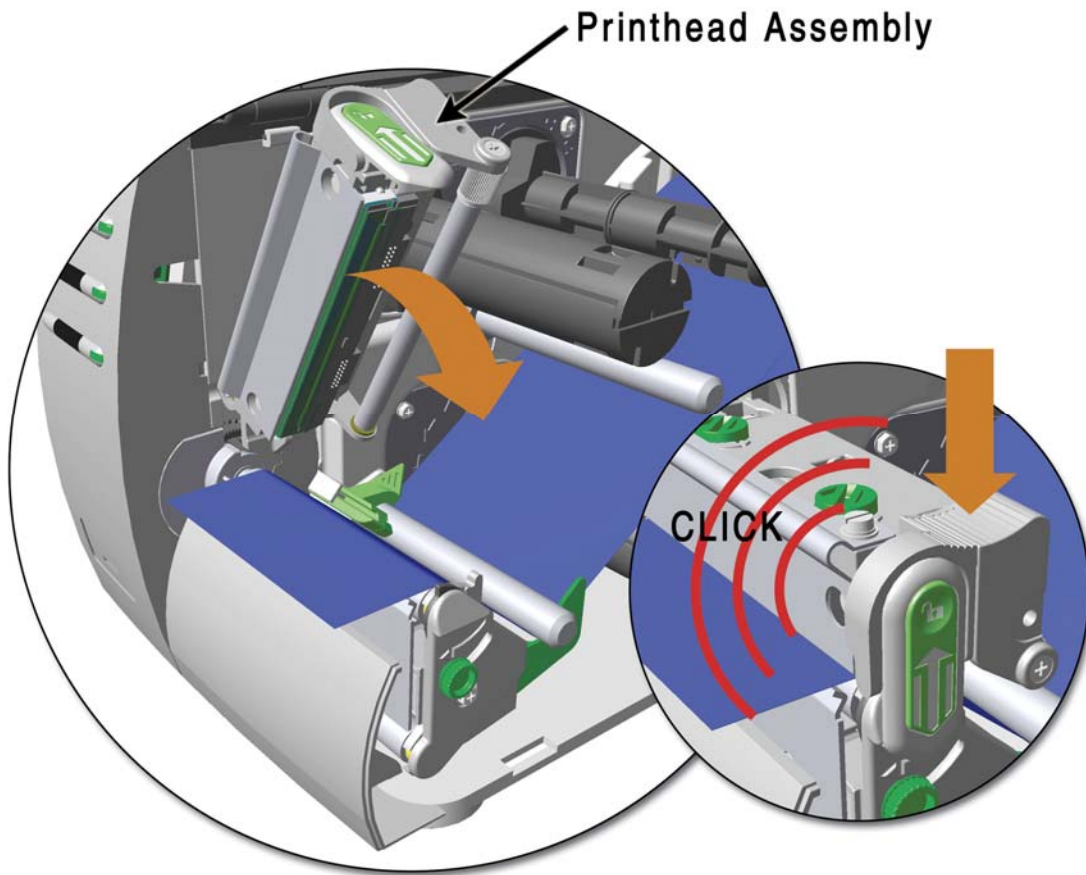

5. Close the Printhead Assembly and press down until it locks into place.



6. Close the cover and press the  FEED button several times to position the media and ensure proper tracking.

If the printer does not correctly sense the top of each label, as denoted by the  ERROR light, it may be necessary to perform the Calibration Procedure, see section 4.7.1.

Note: The printer is factory set to use 4-inch media (and ribbon, if thermal transfer equipped). When using a different width of media/ribbon, please refer to section 5.2.

3.3 Media Sensor Adjustment

The Media Sensor needs to be positioned so that the printer can detect the presence of media and the top-of-form (except for continuous stock, where the TOF is set through the front panel, (see '**CONT FORM LENGTH**', Section 4.5.2). To adjust:

- 1 With media loaded, as described in Section 3.2, grasp the Slide Tab and move the Sensor Eye Mark into position over media according to the table below.
- 2 If loading media, return to the media loading instructions.

<i>Media Sensor Selection and Adjustment</i>		
Media Type	Sensor Eye Mark Position	Sensing Required*
Die-cut	Near the middle of the label	Gap
Notched	Centered over the notch	Gap
Reflective	Centered over the black mark	Reflective
Continuous	Near the middle of the media	Continuous

*See Section 4.5.2 for Sensor Type selection.

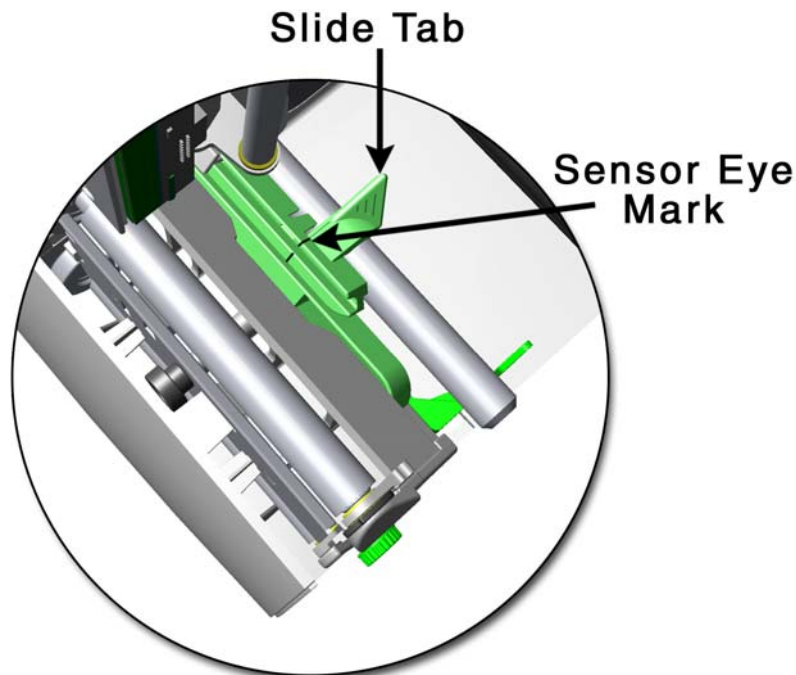

3.4 Loading Ribbon

Ribbon is required with thermal transfer media. It is recommended that the width of the ribbon be slightly wider than the media being used. Depending upon the type of Ribbon Supply Hub (see 3.4.1 for examples), the printer must use either ribbons with the 'coating side in' or ribbons with the 'coating side out'. To load:

Note: Using a ribbon that is slightly wider than your media (and liner, if any) will help protect against printhead wear.

1. Open the media cover. Press in on the Printhead Latch and raise the printhead assembly.

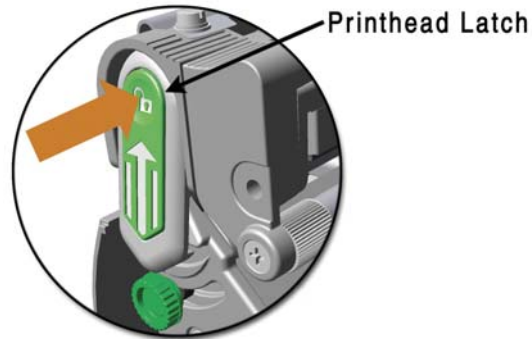

2. Slide the Ribbon Roll onto the Ribbon Supply Hub until it rests against the hub's flange. Ensure the ribbon unwinds in the correct direction (see 3.4.1 for examples). Illustrations depict a 'Coated Side In' assembly.

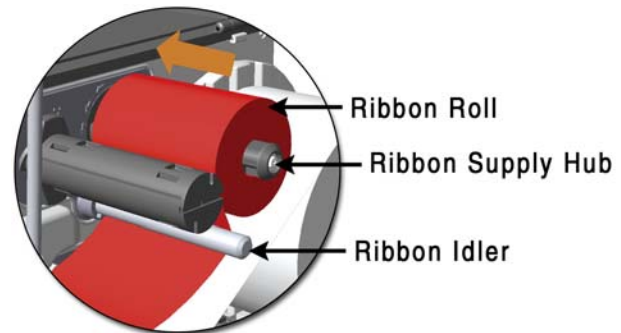

3. Route the ribbon under the Ribbon Idler and then out the front of the printer approximately 12 inches.

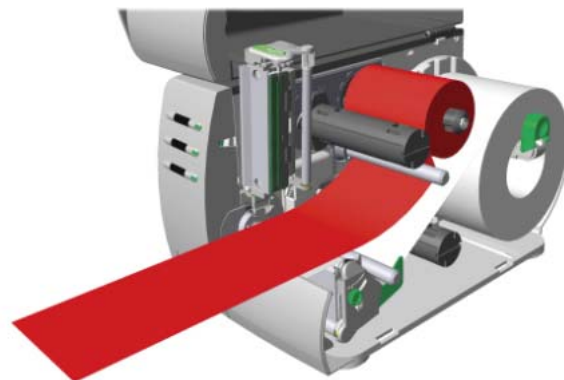

4. Close the Printhead Assembly and press down until it locks into place.

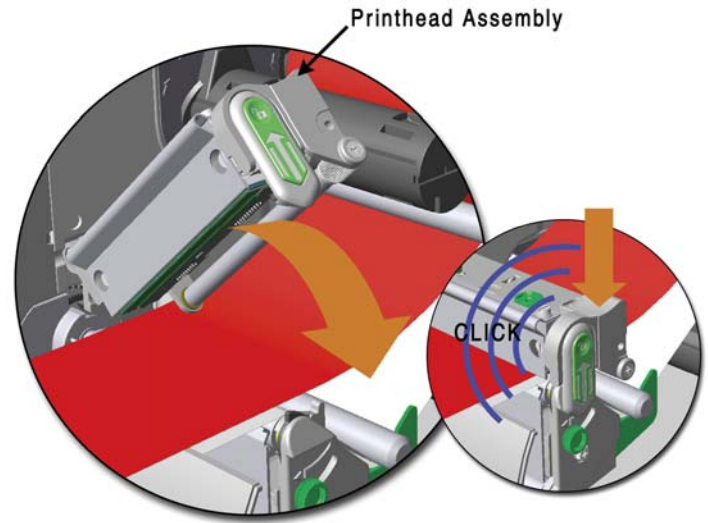

5. Route the ribbon up and then around to the Ribbon Take-Up Hub, winding it several times in a clockwise direction to secure it in place.

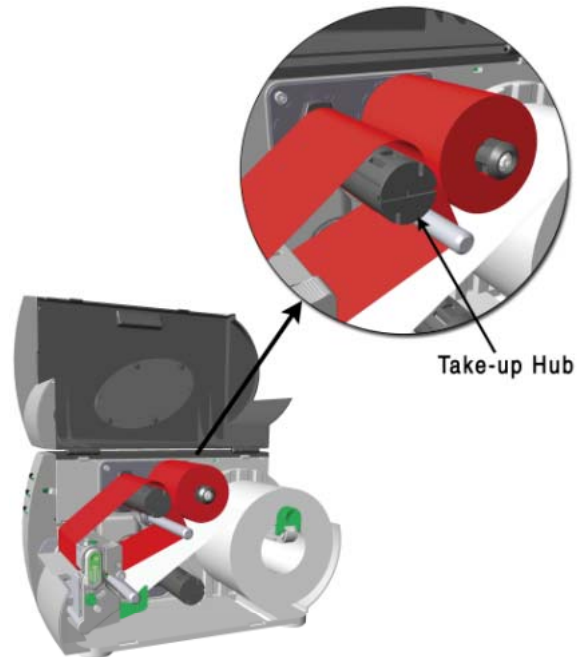

6. Close the cover and press the  FEED button several times to position the ribbon and ensure proper tracking.
7. The 'Media Type' setting within the printer's setup must be set to 'Thermal Transfer' to print using a ribbon, see section 4.5.2.

3.4.1 Ribbon Routing (Coated Side In & Coated Side Out)

Note: Directional Arrows near the Ribbon Supply Hub indicate the correct ribbon route. Ribbon types are available with the ink (coating) layer wound 'in' or 'out'. These types are NOT interchangeable for use with the printer.

Note: Ensure the inked side of the ribbon faces the media and NOT the printhead.

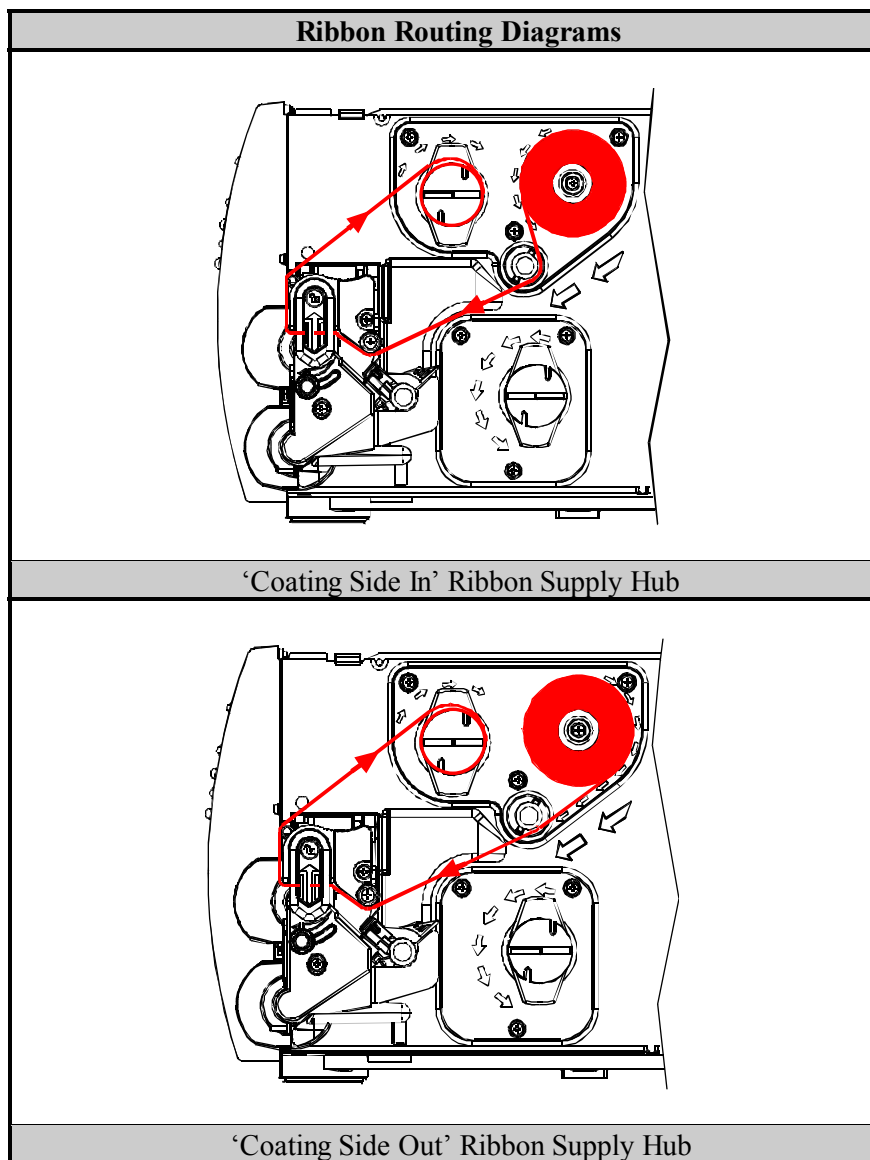

4

Using the Front Panel

4.0 Introduction

The Front Panel consists of three indicator lights and three function buttons. The functions of these lights and controls are listed in the following sections.

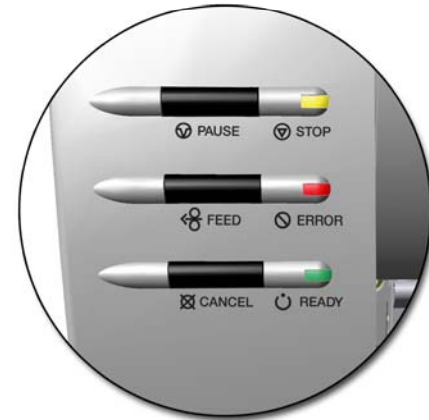

4.1 Lights

(Normal power-up)

Normal Mode

STOP

Solid On: Indicates the printer is in the 'Paused' state

Flashing: (When using the Peel & Present Option) Indicates a label is presented to the operator.

ERROR

Indicates a top of form or mechanical error has occurred

READY

Solid On: Indicates the printer is on and ready for printing

Flashing: Indicates the printer is receiving data from the host

➤ Both the READY and STOP Lights will be on during power-up initialization and a warm reset.

4.2 Buttons

The three buttons,  PAUSE,  FEED, and  CANCEL perform different functions based on the printer's operational mode. The printer operates in one of the following modes:

Normal: Normal printer functions. See Section 4.3.

Express Setup: Allows quick access to the most common printer settings, (Sensor Type, Media Type, and Option Control. See Section 4.4.

Printer Setup: Allows changes to the printer's operational settings. See Section 4.5.





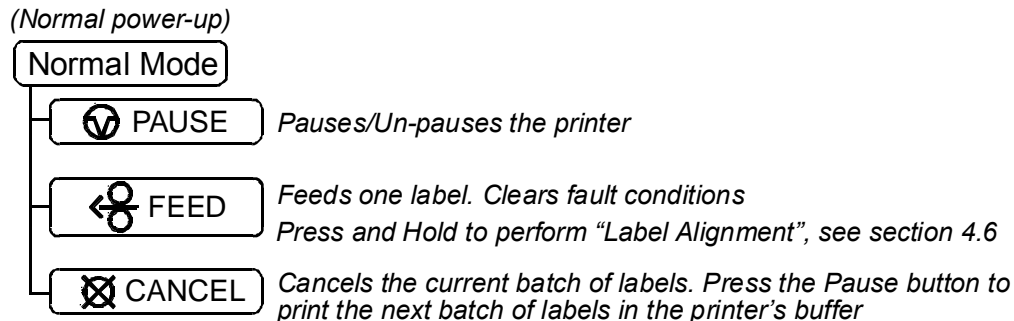

Calibration: Allows the 'calibration' of the media being used for the correct sensing of the top of form. See Section 4.7.

4.3 Normal Mode - Button Functions

In 'Normal' mode, the printer's buttons control normal operations such as pause, feed, and cancel, as well as the test and reset functions by using button combinations as detailed below.



Button Combinations (push buttons simultaneously)

 PAUSE	+	 FEED	Prints the Test Label, see Section 4.8.2.
 PAUSE	+	 CANCEL	Performs a warm reset and returns to the Normal Mode of operation.
 FEED	+	 CANCEL	Produces Database Configuration and Dot Check Labels, see Section 4.8.1

4.4 Express Setup Mode - Button Functions

The Express Setup is a unique printer feature that allows users quick access to the most commonly used printer settings. The selected setting is represented by a specific combination of the printer's indicator lights for each of the three items, (Sensor Type, Media Type, and Option Control). To enter the Express Setup...

Press and Hold the  &  buttons and turn the printer ON. 

Continue to hold the buttons, release when all lights flash, approx. 17 seconds

Use the    buttons for setup.

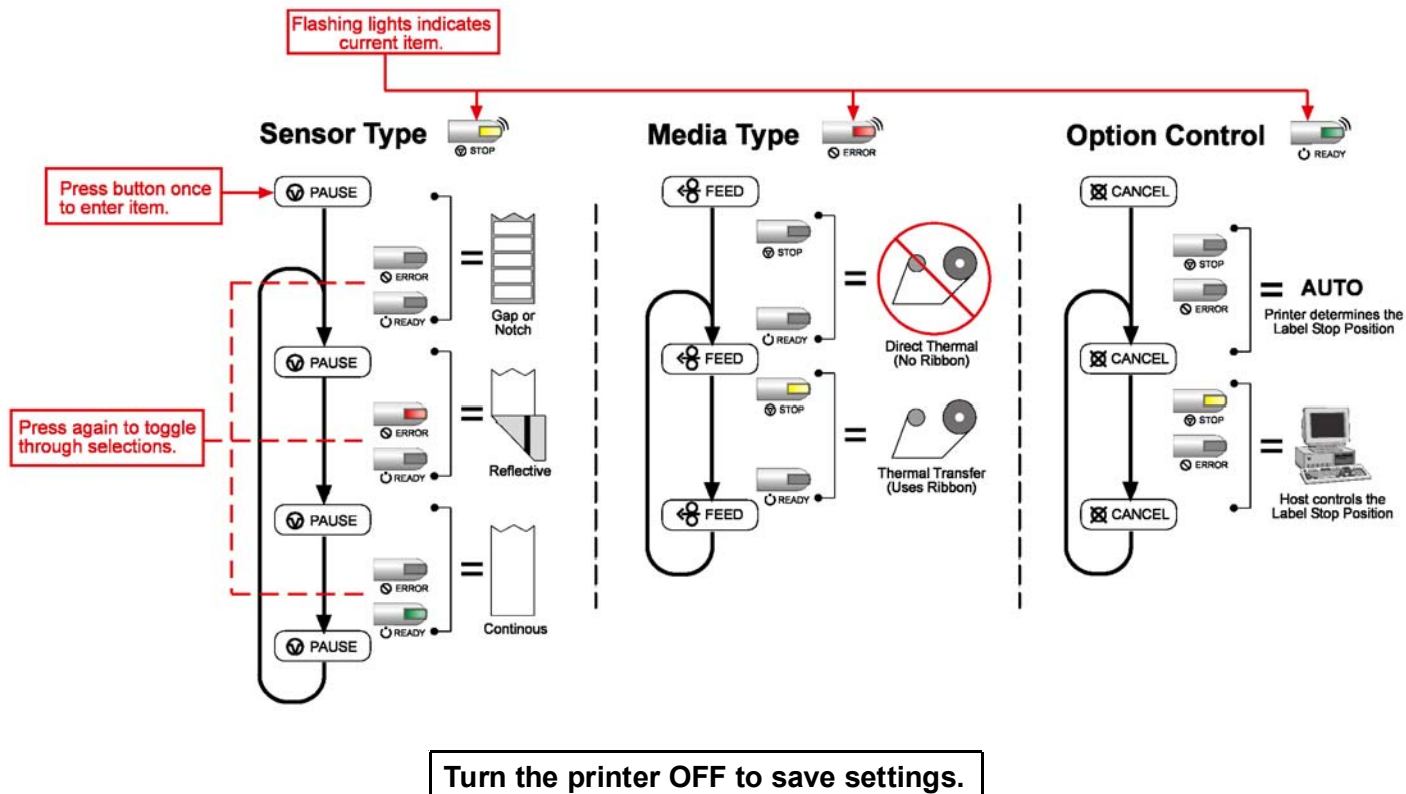

4.5 Printer Setup Mode - Button Functions

In 'Printer Setup' mode, the buttons control the setting of the printer's operational items such as media settings, communications, and options as detailed below.



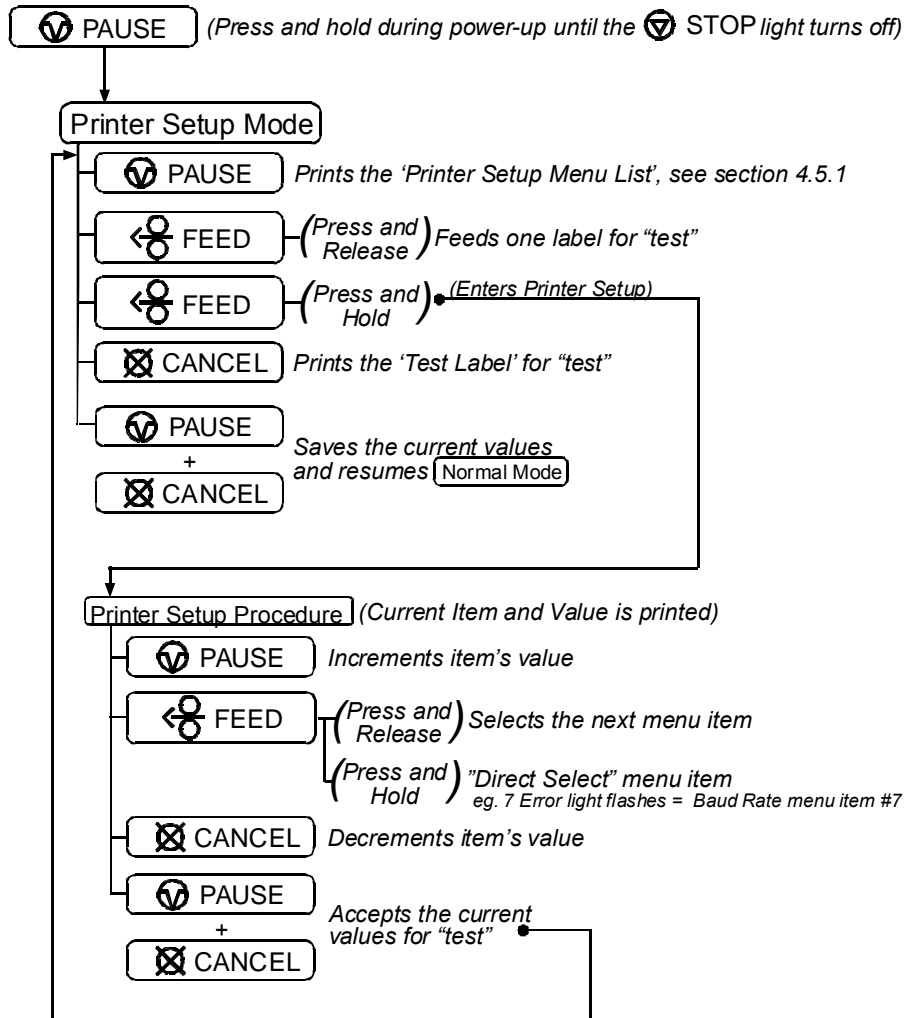

- ☑ **Notes:** It is recommended that the Printer Setup Mode not be entered while in Peel Mode or with the optional Present Sensor enabled. Depending on label size this can cause unpredictable results.
- Printer and cutter faults are disabled during Printer Setup Procedure, but can still occur while printing "test" labels.
- If at any time you wish to discard your changes and revert back to the previous values, simply turn off power to the printer.
- If you wish to restore Factory Defaults see Section 5.7.

To change Printer Setup:



4.5.1 Printer Setup Menu List

The Printer Setup Menu List label, shown below, contains the printer's current values for each menu item that can be modified via the front panel (See Section 4.5.2 for a detailed item description.)

The Menu Item Numbers correspond to the item's position in the Menu List for selection when pressing the  FEED button during the Printer Setup Procedure (see Section 4.5). For example to "Direct Select" the BAUD RATE Menu Item press and hold the  FEED button for 7 flashes of the  ERROR light and then release or for the TOF GAIN item hold  FEED for 12 flashes, etc.

Menu Item Numbers	Values	Menu Items
1)	DIRECT	= MEDIA TYPE
2)	EDGE	= SENSOR TYPE
3)	NO	= PRESENT SENSOR
4)	NO	= CUTTER EQUIPPED
5)	127	= SOP ADJUST, 0.005 in.
6)	127	= PRESENT ADJUST, 0.005 in.
7)	9600	= BAUD RATE, bps
8)	8	= DATA BITS
9)	STD	= CONTROL CODES
10)	100	= CONT FORM LENGTH, 0.01 in.
11)	3	= OOS MAXVOLT, 0.1 Volts
12)	12	= TOF GAIN
13)	10	= TOF DELTA, 0.1 Volts
14)	0	= TOF LOW, 0.1 Volts
15)	426	= LABEL WIDTH, 0.01 in.
16)	64	= SCALABLE FONT, 4KB
17)	128	= INTERNAL MODULE, 4KB
18)	NO	= LABEL ALIGNMENT
19)	100	= ALIGNMENT LENGTH, 0.01 in.
20)	AUTO	= STOP LOCATION
21)	DPL	= INPUT MODE
22)	STANDARD	= DPL EMULATION
23)	10	= HEAT

Note: When using narrow media, the 'Menu Items' column may be truncated.

4.5.2 Menu Items and Values

The table below details the Printer Setup Menu List items with a brief description of the item's function, and the possible values. A "*" denotes the default setting.

<p>1) MEDIA TYPE</p> <p>Sets printing for direct thermal (no ribbon) or thermal transfer (ribbon) media.</p> <p><i>Possible Values:</i></p> <p>* DIRECT THERMAL THERMAL TRANSFER</p>	<p>2) SENSOR TYPE</p> <p>Selects the sensor type used to detect the media's Top Of Form (TOF) mark.</p> <p><i>Possible Values:</i></p> <p>* EDGE: gap / notch TOF marks REFL (Reflective): black marks CONT (Continuous): no TOF marks</p>
<p>3) PRESENT SENSOR</p> <p>Enables/Disables the optional Present Sensor feature.</p> <p><i>Possible Values:</i></p> <p>* AUTO NO YES</p>	<p>4) CUTTER EQUIPPED</p> <p>Enables/Disables the optional Media Cutter feature.</p> <p><i>Possible Values:</i></p> <p>* AUTO NO YES</p>
<p>5) SOP ADJUST</p> <p>Sets the start of print (SOP) location, relative to the top of form.</p> <p><i>Possible Values:</i></p> <p>Range: 0 – 255; nominal = *128 (0 = close to edge; 255 = farthest from edge)</p>	<p>6) PRESENT ADJUST</p> <p>Specifies an additional amount to feed the label after printing.</p> <p><i>Possible Values:</i></p> <p>Range: 0 – 255; nominal = *128 (0 = close to edge; 255 = farthest from edge)</p>
<p>7) BAUD RATE</p> <p>Sets the serial port baud rate. (Must match the host setting).</p> <p><i>Possible Values:</i></p> <p>600 to 38.4k; default = *9600 BPS</p>	<p>8) DATA BITS</p> <p>Sets the serial data word length (Must match the host setting).</p> <p><i>Possible Values:</i></p> <p>* 8 7</p>

<p>9) CONTROL CODES</p> <p>Allows code selection listed in Programmer's manual.</p> <p>Possible Values:</p> <p>* (STD) Standard Codes (ALT) Alternate Codes</p>	<p>10) CONT FORM LENGTH</p> <p>Sets the page (label) size when the 'SENSOR TYPE' is set to continuous media.</p> <p>Possible Values:</p> <p>Range: 0 – 9999; default = *100 (Units = .01 inch)</p>
<p>11) OOS MAXVOLT</p> <p>Sets the media sensor level for the Out Of Stock condition.</p> <p>Possible Values:</p> <p>Range: 0 – 16; nominal = *2 (Units = .1 volt)</p>	<p>12) TOF GAIN</p> <p>Sets media sensor Top of Form gain value.</p> <p>Possible Values:</p> <p>Range: 0 – 15; nominal = *10</p>
<p>13) TOF DELTA</p> <p>Sets the minimum media sensor change required to signify a label gap or mark.</p> <p>Possible Values:</p> <p>Range: 0 – 50; nominal = *10 (Units = .1 volt)</p>	<p>14) TOF LOW</p> <p>Sets the minimum media sensor reading for paper (gap/notch) or mark (reflective).</p> <p>Possible Values:</p> <p>Range: 0 – 50; nominal = *0 (Units = 0.1 volt)</p>
<p>15) LABEL WIDTH</p> <p>Sets the label width.</p> <p>Possible Values:</p> <p>Range: 75 – 426; default = *426 (Units = .01 inch)</p>	<p>16) SCALABLE FONT</p> <p>Sets the number of memory blocks to allocate for scalable fonts.</p> <p>Possible Values:</p> <p>Range: 0 – 128; default = *64 (Units = 4K Bytes)</p>
<p>17) INTERNAL MODULE</p> <p>Sets the number of memory blocks to allocate for the internal RAM module.</p> <p>Possible Values:</p> <p>Range: 0 – 128; default = *128 (Units = 4K Bytes)</p>	<p>18) LABEL ALIGNMENT</p> <p>Sets the label alignment method (<i>see Section 4.6</i>).</p> <p>Possible Values:</p> <p>YES (user manually determines 'ALIGN LENGTH')</p> <p>AUTO (printer determines 'ALIGN LENGTH')</p> <p>* NO (no Label Alignment used)</p>

<p>19) ALIGN LENGTH</p> <p>Leading edge distance of two successive labels. Must be entered if ‘LABEL ALIGNMENT’ is set to Yes (see Section 4.6).</p> <p>Possible Values:</p> <p>0 – 999; default =100* (Units = .01 inch)</p>	<p>20) STOP LOCATION</p> <p>Sets label stopping (and in certain cases the starting) location for different printer configurations.</p> <p>Possible Values:</p> <p>* AUTO (Automatically sets the stop location. Installed options will be ‘auto-sensed’ and the appropriate stop position will automatically be set. Host commands are ignored.)</p> <p>HOST (Sets stop position according to options installed. If no options are installed the printer sets stop location to the next label’s start of print. Host commands will override.)</p>
---	---

<p>21) INPUT MODE</p> <p>Selects between the standard or template interpretation of incoming data.</p> <p>Possible Values:</p> <p>* DPL (printer constructs the label using the standard DPL commands)</p> <p>LINE (printer constructs the label using a preloaded template form)</p>	<p>22) DPL EMULATION</p> <p>This instructs the firmware to process specific DPL data (Start of Print, DPI, and Imaging function) according to the selected printer emulation.</p> <p>Possible Values:</p> <p>* STANDARD</p> <p>ALLEGRO (Allegro Emulation)</p> <p>P PLUS (Prodigy Plus Emulation)</p> <p>PRODIGY (Prodigy Emulation)</p>
---	--





<p>23) HEAT</p> <p>Controls the ‘burn-time’ of the printhead. This is the equivalent of Heat Setting on most label software programs.</p> <p>Possible Values:</p> <p>Range: 0 – 30; default = *10</p>

Note: All of the menu items listed in the previous section are stored in non-volatile memory.

4.5.3 Step by Step Modification of the Printer Setup

The following is an example of Printer Setup modification. Although this example will detail how to modify the serial Baud Rate, the same method can be used to change any of the printer's menu item settings.

Note: It is recommended that the Printer Setup Mode not be entered while in Peel Mode or with the optional Present Sensor enabled. Depending on label size this can cause unpredictable results.

1. With printer 'Off' and properly loaded with media, press and hold the  PAUSE button while powering 'On' the printer. Continue to hold the button until the  STOP light turns off, then release it.
2. Press and hold the  FEED button and count 7 flashes of the  ERROR light, then release it. The following printout should be produced:

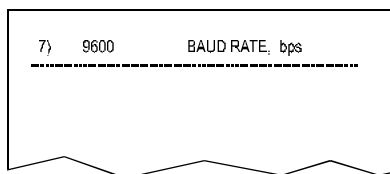



7) 9600 BAUD RATE, bps

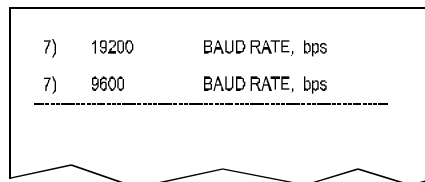

3. Press the  PAUSE button one time to increment to the 19200 bps value. The following printout should be produced:





7) 19200 BAUD RATE, bps
7) 9600 BAUD RATE, bps

4. At this point you will accept the current values for "test" and exit the Printer Setup Procedure by simultaneously and briefly pressing the  PAUSE +  CANCEL buttons. Wait until the  STOP light goes off.

Note: If you wish to discard your changes and revert back to the previous values simply turn off power to the printer before Step 5.

5. Now you can save your changes and resume **Normal Mode** by simultaneously and briefly pressing the  PAUSE +  CANCEL buttons. Wait until the  STOP light goes off.

6. To confirm that your changes have been made press the  FEED +  CANCEL buttons simultaneously, this will print the Database Configuration Label. The label should show the new Baud Rate value of 19200.

```

FRI JANUARY 10, 2003 19:29 010
UER: M4206 - 05.03 01/07/03
BOOT 83-2383-05C
CODE 83-2385-05C
FPGA 83-2384-05A
FONT 83-2386-05C
 256K FLASH MODULE B
SYSTEM FLASH SIZE___2 MBYTES
SYSTEM RAM CHECKS___GOOD
SYSTEM RAM SIZE___4096 KBYTES
SYSTEM RAM AVAIL___3180 KBYTES

AUTO DETECTION
CUTTER___NOT DETECTED
PRESENT SENSOR___NOT DETECTED
CURRENT STOP LOC___TEAR

EXPRESS SETUP
MEDIA SENSOR___EDGE
PRINT METHOD___TRANSFER
OPTION CONTROL___AUTO

INPUT VALUES
PAPER___207
DARKNESS___119
TRAM___157
REFL___0
RIBN___237
TEMP___64
VOLT___218
PRESENT SENSOR___0

CONFIGURATION
SERIAL PORT SELECTED
19.2:  BITS
EDGE
MEDIA TYPE___TRANSFER
CONT FORM LENGTH___0
PRESENT ADJUST___128
SOP ADJUST___128
TOF LOW___0 0
TOF DELTA___10 10
TOF GAIN___7 5
OOS MAXVOLT___3 2
LABEL ALIGNMENT___AUTO
ALIGN LENGTH___611
STOP LOCATION___AUTO
INPUT MODE___DPL
DPL EMULATION___STANDARD
HEAT___10

COUNTER INFORMATION
ABSOLUTE VALUES 1- 7-2003
LENGTH___773 INCHES
TIME___20 HOURS
RESETTABLE VALUES 1- 7-2003
LENGTH___576 INCHES
TIME___10 HOURS

MEMORY CONFIGURATION
INTERNAL MODULE A___128
SCALABLE FONTS___64
LABEL SIZE 0426:11255 IN

```

The new
19200
Baud
Rate

4.6 Label Alignment

The Label Alignment function is intended for use when the label length is less than the distance between the printhead and the media sensor or where label waste at power-up is a concern. Label Alignment (see table below) is not recommended for label lengths greater than 6.5 inches or for media containing 2 or more form lengths.

Label Stock	Label Alignment Setting
Continuous	NO
6.5 inches or less	YES or AUTO
6.5 inches or more	NO
Multiple length labels	NO

The Label Alignment function is chosen via the menu system (see Section 4.5) or by host commands. The three possible modes, YES, AUTO, and NO, are detailed in the following sections.

4.6.1 Label Alignment = YES

In this mode, the operator must supply an 'ALIGN LENGTH' value. This value must be physically measured from leading edge to leading edge of two successive labels, as shown. The measurement must be as accurate as possible. For very short labels, errors as small as 0.01" can result in noticeable print variations on the labels between the media sensor and the printhead.

The measured value must be sent to the printer via the host computer or entered using the Printer Setup Mode (see Section 4.5).

Then, in Normal Mode, press and hold the  FEED button (about 4 seconds). The printer will align the label to the top of form position.

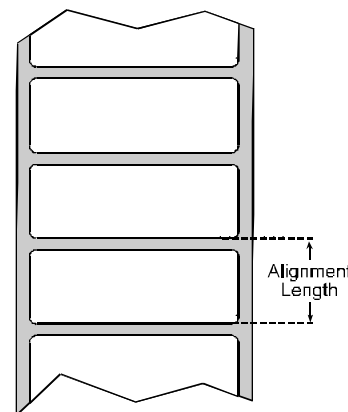



Note: If media with a different label length is subsequently loaded, the 'ALIGN LENGTH' must be recalculated and re-entered.

4.6.2 Label Alignment = AUTO

In this mode, the printer automatically calculates the 'ALIGN LENGTH' thus eliminating the need to physically measure the label. This mode is usually preferred in applications that require frequent media changes to labels of different lengths.

To perform an Auto Alignment, in Normal Mode press and hold the  FEED button (about 4 seconds). The printer will feed labels to calculate the label length. Following the calculation, the printer will save the measurement and align to the top of form position. Auto Alignment can result in wasted labels during the measurement process (the longer the label length the greater the waste).

Auto Alignment with the Present Sensor enabled:





If the printer is equipped with the Present Sensor option and that feature is enabled, while the label length is calculated the printer will pause and illuminate the  STOP light after each movement. The operator must press the  PAUSE button for the alignment to continue. This allows the operator to remove any labels as required; however, labels should not be forcibly removed since they may not actually be positioned for removal, but at an interim position required for measurement.



4.6.3 Label Alignment = NO

When Label Alignment is not enabled (i.e., set to NO), printing begins at the current label position without alignment, assuming the label is at the start of print position. Additionally, if the label length is short, labels between the printhead and the media sensor may be unused.

4.6.4 Label Alignment Troubleshooting

If you experience label alignment problems, the following table offers possible causes and solutions.

Problem	Possible Cause	Solution
Attempting to perform Label Alignment results in no paper movement.	With the Present Sensor enabled, Label Alignment cannot be performed without a Label Length.	<ul style="list-style-type: none"> ➤ Set Label Alignment to AUTO, press and hold  FEED until media moves for the automatic length measurement. <p style="text-align: center;">~OR~</p> <ul style="list-style-type: none"> ➤ Re-measure the Label Alignment Length. Use Printer Setup mode to enter the new length. Print a Database Configuration label to ensure the new length has been set.
First label is wasted during alignment. All labels thereafter print to the correct start of print position.	<p>Alignment Length is too long.</p> <p style="text-align: center;">~OR~</p> <p>For labels whose length and stop position cause them to stop between labels on the media sensor, the alignment function can result in wasted labels.</p>	<ul style="list-style-type: none"> ➤ Set Label Alignment to AUTO, press and hold  FEED until paper moves for automatic Label Alignment length measurement. <p style="text-align: center;">~OR~</p> <ul style="list-style-type: none"> ➤ Re-measure Label Alignment Length, use Menu Setup to set new length, ensure desired length has been set. ➤ Obtain a slightly different label Alignment Length measurement. Using the Label Alignment AUTO mode, hold the  FEED button to force an alignment and label measurement. Ensuring slack in the label stock may result in a slightly different measurement. The Alignment Length may also be set manually via the Setup Menu. Increasing or decreasing the value by 1 or 2 units (in./100) may help to prevent the wasted labels; however, this may result in incorrect print positions for labels that are short in length.
Label Alignment is incorrect. Pressing  FEED successively results in a short label length, one-inch.	Label Alignment Length is not correct. The default Label Alignment Length is 1.00", and will result in this behavior when any larger label length is used without setting the appropriate length.	<ul style="list-style-type: none"> ➤ Set Label Alignment to AUTO. Press and hold  FEED until paper moves for automatic Label Alignment Length measurement. <p style="text-align: center;">~OR~</p> <ul style="list-style-type: none"> ➤ Measure the label length and use the Setup Menu to set the new length. Print a Database Configuration label to ensure the new length has been set.

Problem	Possible Cause	Solution
<p>Label Alignment is incorrect. Pressing  FEED successively results in a label length longer than actual, one-inch.</p>	<p>Label Alignment Length is not correct. The default Label Alignment Length is 1.00", and will result in this behavior when any larger label length is used without setting the appropriate length</p>	<ul style="list-style-type: none"> ➤ Set Label Alignment to AUTO. Press and hold  FEED until paper moves for automatic Label Alignment length measurement. <p style="text-align: center;">~OR~</p> <ul style="list-style-type: none"> ➤ Measure the label length and use the Setup Menu to set the new length. Print a Database Configuration label to ensure the new length has been set.
<p>Tear Mode is selected but the label stop position (present position) is not far enough forward.</p>	<p>Another present position has been determined. Enabling the Present Sensor causes the label stop position (present position) to be approximately 0.1" behind the peel bar.</p> <p style="text-align: center;">~OR~</p> <p>The Present Adjust value is not correct.</p>	<ul style="list-style-type: none"> ➤ Disable the Present Sensor. <p style="text-align: center;">~OR~</p> <ul style="list-style-type: none"> ➤ Ensure the host computer is not providing a Present Distance shorter than is required for the Tear Bar. <p style="text-align: center;">~OR~</p> <ul style="list-style-type: none"> ➤ Use the Setup Menu to modify the Present Adjust value.
<p>Tear Mode is selected but the label stop position (present position) is too far forward.</p>	<p>Another present position has been determined.</p> <p style="text-align: center;">~OR~</p> <p>The Present Adjust value is not correct.</p>	<ul style="list-style-type: none"> ➤ Ensure the host computer is not providing a Present Distance longer than is required for the Tear Bar. <p style="text-align: center;">~OR~</p> <ul style="list-style-type: none"> ➤ Use the Setup Menu to modify the Present Adjust value.
<p>The  ERROR light illuminates during label alignment.</p>	<p>The label supply is empty</p>	<ul style="list-style-type: none"> ➤ Load media.

4.7 Calibration Mode – Button Functions

In 'Calibration' mode, the buttons allow the printer to adjust to the media being used. Calibration can be performed either automatically or manually, as detailed below.

Notes: Before calibrating, ensure that the Printhead Carrier Assembly is latched down, that the cover is closed, and that the media sensor has been set for the appropriate media type, see Section 4.5.2.

Printer and cutter faults are disabled during **Auto Media Calibration** and **Media Sensor Calibration**, but can still occur while printing "test" labels.

If at any time you wish to discard your changes and revert back to the previous calibration simply turn off power to the printer. Also, Factory Defaults can be restored, see Section 5.7

To perform Calibration:

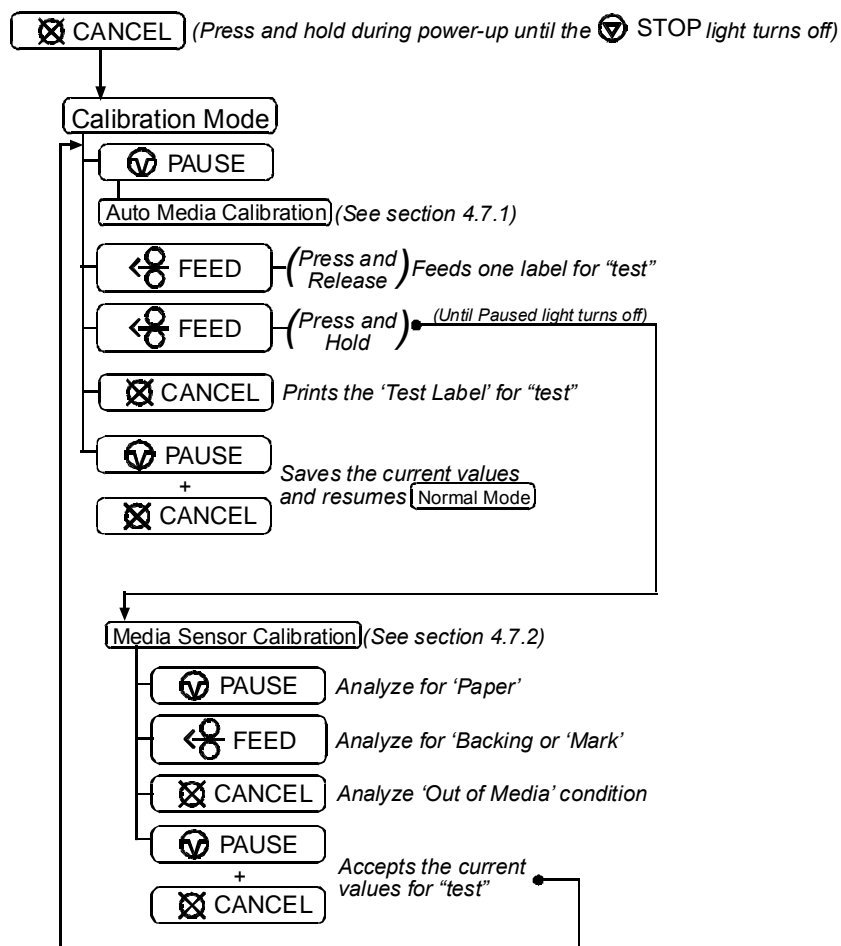





4.7.1 Auto Media Sensor Calibration



Auto Media Sensor Calibration automatically establishes the optimum sensing values for the media you are using in the printer.

✔ Note: Before calibrating, be sure the media sensor is set for the appropriate media type, see Section 4.5.2; also, ensure that the Printhead Carrier Assembly is latched down and the cover is closed.

To automatically calibrate the media sensor:

1. With the desired media loaded, hold the  CANCEL button while powering up the printer. Continue to hold the button until the  STOP light turns off then release it.
2. Next press the  PAUSE button. *The printer will feed approximately ten inches of media to calculate the TOF Delta and Low values to be used.*
3. Upon completion, one of the following lights will flash five times to denote the result of the auto calibration attempt:
 -  STOP light = Successful calibration. Proceed to Step 4.
 -  ERROR light = Unsuccessful calibration, try again. If the calibration continues to fail proceed to Section 4.7.2.

✔ Note: If you wish to discard the changes and revert back to the previous calibration simply turn off the printer before Step 4.

















4. Now save the changes and resume **Normal Mode** by pressing the  PAUSE +  CANCEL buttons simultaneously and briefly. Wait until the  STOP light goes off.



4.7.2 Manual Media Sensor Calibration

The Manual Media Sensor Calibration procedure should be used in cases where the printer continues to suffer from media sensing problems after performing or attempting to perform the Auto Media Sensor Calibration (see Section 4.7.1).

Note: Before calibrating, be sure the media sensor is set for the appropriate media type, see Section 4.5.2; also, ensure that the Printhead Carrier Assembly is latched down and the cover is closed.

To manually calibrate the media sensor:

1. Hold the  CANCEL button and power-up the printer. Continue to hold the button until the  STOP light turns off; then release the button. Next, press and hold the  FEED button, continue to hold the button until the  STOP light turns on; then release the button.
2. Remove all the material from the media sensor, (see Section 3.3 for the sensor's location), close the Printhead Carrier Assembly, and then press the  CANCEL button. *The printer will flash the  ERROR light as it analyzes the no media condition.*
3. Position the backing material or the black (reflective) mark in the media sensor, close the Printhead Carrier Assembly, and then press the  FEED button. *The printer will flash the  ERROR light as it analyzes the top of form mark.*
4. Place the media with the backing attached (if any) in the media sensor, close the Printhead Carrier Assembly, and then press the  PAUSE button. *The printer will flash the  ERROR light as it analyzes the material.*
5. Simultaneously and briefly press the  PAUSE +  CANCEL buttons to accept the calibration for “test” and exit the **Media Sensor Calibration**. One of the following lights will flash five times to denote the result of the manual calibration attempt:
 -  STOP light = Successful calibration. Proceed to Step 6.
 -  ERROR light = Unsuccessful calibration. Retry the procedure beginning at Step 1.
6. Use the  FEED button (feeds a label), and the  CANCEL button (prints a test label) to test the current calibration.

Note: If you wish to discard the changes and revert back to the previous calibration simply turn off the printer before Step 7.
7. Now save the changes and resume **Normal Mode** by pressing the  PAUSE +  CANCEL buttons simultaneously and briefly. Wait until the  STOP light goes off.



4.8 Internal Labels

The following section details the printer's internally generated configuration and test labels.

4.8.1 Database Configuration and Dot Check Labels

The Database Configuration Label provides valuable printer information including the firmware version, memory allocations, enabled options, and label-counter data.

To print the Database Configuration and Dot Check Labels:

With the printer on, loaded with media (at least 4 inches wide) and ribbon (if printing with thermal transfer media), press the  FEED +  CANCEL buttons simultaneously.

The first label printed will be the Database Configuration Label.

```
FRI JANUARY 10, 2003 19:29 010
VER: M4206 - 05.03 01/07/03
BOOT 83-2383-05C
CODE 83-2385-05C
FPGA 83-2384-05A
FONT 83-2386-05C
 256K FLASH MODULE B
SYSTEM FLASH SIZE___2 MBYTES
SYSTEM RAM CHECKS___GOOD
SYSTEM RAM SIZE___4096 KBYTES
SYSTEM RAM AVAIL___3180 KBYTES

AUTO DETECTION
CUTTER___NOT DETECTED
PRESENT SENSOR___NOT DETECTED
CURRENT STOP LOC___TEAR

EXPRESS SETUP
MEDIA SENSOR___EDGE
PRINT METHOD___TRANSFER
OPTION CONTROL___AUTO

INPUT VALUES
PAPER___207
DARKNESS___119
TRAN___157
REFL___0
RIBN___237
TEMP___64
VOLT___218
PRESENT SENSOR___0

CONFIGURATION
SERIAL PORT SELECTED
19.2; 8BITS
EDGE
MEDIA TYPE___TRANSFER
CONT FORM LENGTH___0
PRESENT ADJUST___128
SOP ADJUST___128
TOF LOW___0 0
TOF DELTA___10 10
TOF GAIN___7 5
OOS MAXVOLT___3 2
LABEL ALIGNMENT___AUTO
ALIGN LENGTH___611
STOP LOCATION___AUTO
INPUT MODE___DPL
DPL EMULATION___STANDARD
HEAT___10

COUNTER INFORMATION
ABSOLUTE VALUES 1- 7-2003
LENGTH___773 INCHES
TIME___20 HOURS
RESETTABLE VALUES 1- 7-2003
LENGTH___576 INCHES
TIME___10 HOURS

MEMORY CONFIGURATION
INTERNAL MODULE A___128
SCALABLE FONTS___64
LABEL SIZE___0426:11255 IN
```

The second label printed is the Dot Check Label. This label is used to test the condition of the printhead, as shown below:

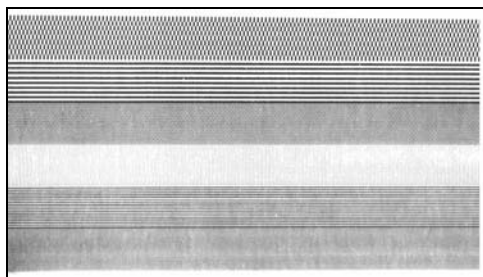

Good Dot Check Label:

Even pattern consistency indicates that the printhead is operating normally.

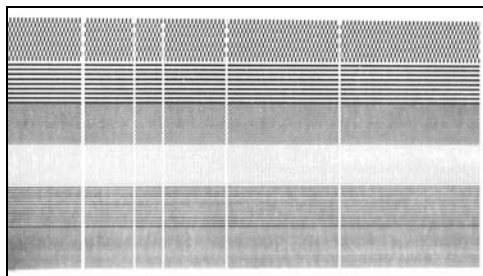



Faulty Dot Check Label:

Streaks in the patterns indicate a dirty or faulty printhead (see Chapter 5).

4.8.2 Test Label

The Test Label is used to evaluate the current printer setup for print quality, label tracking, and print positioning.

To print the Test Label:



With the printer loaded with media (at least 4 inches wide), and ribbon (if printing with thermal transfer media), simultaneously press the  PAUSE +  FEED buttons.



4.8.3 Hex Dump Label

The Hex Dump Label is a useful tool in the diagnosis of problems including communications handshaking and DPL syntax errors. To generate a Hex Dump Label the printer enters into Hex Dump Mode. In this mode, all data sent to the printer will be immediately output in hexadecimal code, along with the printable ASCII equivalents. To decode this information, the *Programmer's Manual* is an essential reference. As a final note, many software programs use bit mapping to construct the label, making diagnosis of this data difficult. Contact Datamax Technical Support with any questions.

To print the Hex Dump Label:

With the printer on, loaded with media (at least 4 inches wide) and ribbon (if printing with thermal transfer media), press and hold the  FEED button while turning the printer on. Continue holding the  FEED button until the  STOP light turns off. Now, all data received by the printer will be output in hexadecimal code, as shown below.

```
0000 02 4C 0D 44 31 31 0D 31 ^L_011.1
0006 36 31 31 30 30 30 30 33 61100003
0010 32 30 30 30 31 30 46 4F 200010F0
0018 4E 54 20 36 3A 20 41 4C NT 6: AL
0020 4C 20 56 41 4C 49 44 20 L VALID
0028 20 20 20 20 20 20 20 20
0030 20 20 20 0D 31 36 31 31 1611
0038 30 30 30 30 32 38 30 30 00002800
0040 30 31 30 20 20 20 20 20 010
0048 20 20 20 43 48 41 52 41 CHARA
0050 43 54 45 52 53 3A 0D 31 CTERS: 1
0058 36 31 31 30 30 30 30 32 61100002
0060 34 30 30 30 31 30 23 24 400010#$
0068 25 26 28 29 2A 2B 2E 2D %&()*+,-
```

To exit the Hex Dump Mode:

Turn the printer off.



Maintenance and Adjustments

5.0 Introduction

This chapter details the cleaning, adjusting, and troubleshooting tips for the printer. The following table outlines the recommended maintenance schedule for the various printer parts.

Area	Method	Interval
Printhead	Turn off the printer before cleaning the printhead. Use solvent* on a cotton swab to clean the printhead from end to end.	After every roll of media.
Platen Roller	Turn the power off. Rotate the platen roller and clean it thoroughly with solvent* and a cotton swab.	After every roll of media.
Peel-Off Roller	Rotate the peel-off roller and clean it thoroughly with solvent* and a cotton swab.	After every roll of media.
Media Path	Solvent*	After every roll of media.
Peel/Tear Bar	Solvent*	As needed
Media Sensor	Air blow	Monthly
Exterior	Mild detergent or desktop cleaner.	As needed
Interior	Brush or vacuum cleaner	As needed.

* It is recommended that a solvent containing isopropyl alcohol be used.



Warning

Isopropyl alcohol is a flammable solvent, always take the proper precautions when using this substance.

5.1 Cleaning the Printhead

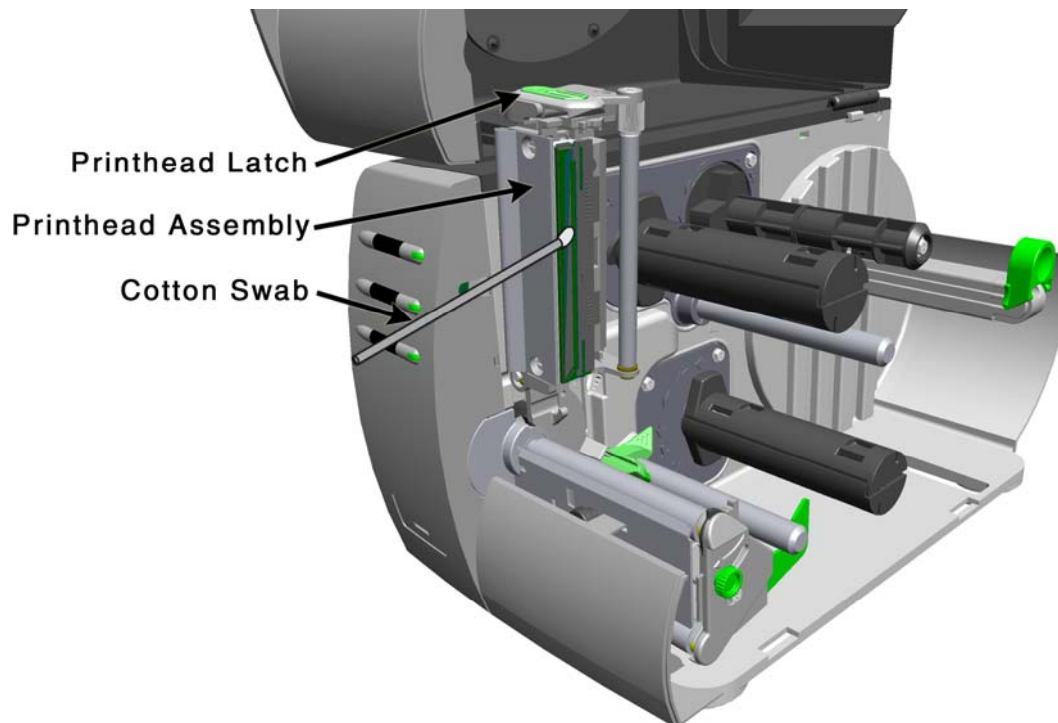

If print quality declines (symptoms include non-compliant bar codes, print dropouts, streaks), the typical cause is debris build-up on the printhead. Furthermore, when the build-up is not removed it may lead to element failure, greatly reducing the life of the printhead. To clean the printhead:

1. Turn 'Off' and unplug the printer.
2. Open the cover. Unlock the Printhead Latch and raise the Printhead Assembly. **Allow the printhead to cool before proceeding.**
3. Move media and ribbon away from the printhead as necessary.
4. Using a Cotton Swab moistened, not soaked, with isopropyl alcohol gently wipe away any build-up on the printhead surface, paying close attention to the Burn Line. Allow the printhead to dry.
5. Replace the ribbon and media. Lower the Printhead Assembly back to the locked position.
6. Close the cover. Plug in and turn 'On' the printer. Feed several labels to normalize tracking.



5.2 Media Width Adjustment

When printing on less than full width media, the printer has a printhead-leveling cam to adjust the right side of the printhead for even pressure distribution. To adjust the leveling cam:

1. With media loaded in the printer, print a label (press the  FEED +  CANCEL buttons simultaneously) and examine it..
2. While observing the printed labels, loosen the Thumbscrew and move it to the left most position. (see Example 1, below).
3. Next, move the Thumbscrew to the right until the printed labels contain a complete, even image (see Example 2). Tighten the Thumbscrew.

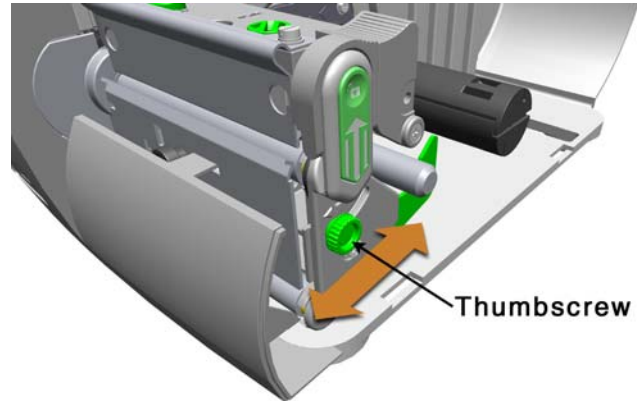

When changing to a different width of label, readjust the Leveling Cam.

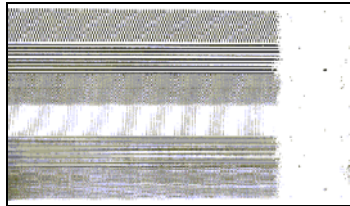

Example 1 – Over adjustment:

Too much adjustment produces an image that fades across the label. To correct this, move the Thumbscrew to the right.

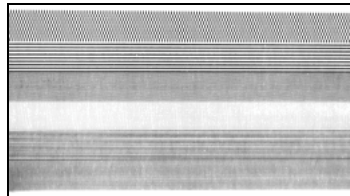

Example 2 – Correct adjustment:

The proper adjustment produces a complete image with even print contrast across the label (see note below).

Note: Under-adjustment of the Leveling Cam: Problems can include ribbon wrinkling, label tracking, and platen roller and printhead wear.



5.3 Printhead Burn Line Adjustment

The Burn Line has been adjusted at the factory for strict compliance using 6.5-mil (.0065 inch) media, ensuring print quality across a majority of media types. In extreme cases, however, if media of a different thickness or rigidity is used (for example, heavy tag stock), print quality can change. Typically, thicker media requires a slight forward adjustment, while thinner media requires a slight backward adjustment.



If you have questions, contact a qualified technician or Datamax Technical Support before proceeding.

To adjust the Burn Line:

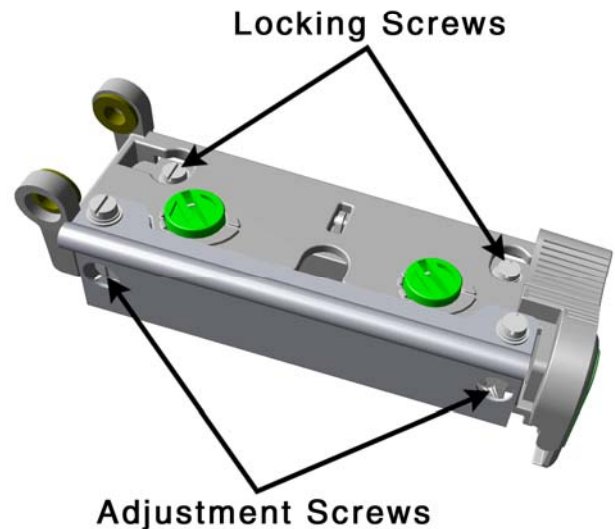

1. Load the printer with your media (and ribbon, if required).
2. Loosen the two Locking Screws approximately $\frac{1}{4}$ turn counter-clockwise.
3. Turn the Adjustment Screws counter-clockwise until the burn line is past the platen roller vertex. Print a test label (press the  PAUSE +  FEED buttons simultaneously). The label should look light and uneven.
4. Tighten the Locking Screws just until they are 'snug' (tight enough to remove any play in the printhead assembly, yet loose enough to allow the Adjustment Screws to move the printhead).
5. Turn each Adjustment Screw clockwise about a $\frac{1}{4}$ turn (or an $\frac{1}{8}$ turn for finer adjustments, see note below). Print another test label and examine the print quality. Repeat this step until the labels are produced with even print contrast and acceptable print quality are produced.
6. Tighten the Locking Screws. Print a final Test label to verify the adjustment.



Note: *When the Locking Screws are 'snug', turning the Adjustment Screws counter-clockwise will NOT move the printhead outward; if you have adjusted the printhead too far inward, restart the entire procedure.*

5.4 Printhead Pressure Adjustment

To accommodate a variety of media types, the pressure applied by the printhead assembly is adjustable. This pressure is factory set to work with most media types, so this adjustment should only be performed after attempting to improve print quality through the use of the (1) heat and/or (2) print speed. When adjusting, use only the minimum pressure necessary for better imaging. To adjust:

1. Load at least 4" (102mm) wide media and ribbon, see Section 3.2.
2. Ensure the Media Width Adjustment is set to its "left most" position, see Section 5.2.
3. Press the  FEED +  CANCEL buttons simultaneously to print a 'Configuration/Dot Check' test label.
4. Turn the Printhead Pressure Adjustment Screws counterclockwise to increase the applied pressure or clockwise to decrease it. Make equal adjustments to each screw to achieve even print contrast across the media.

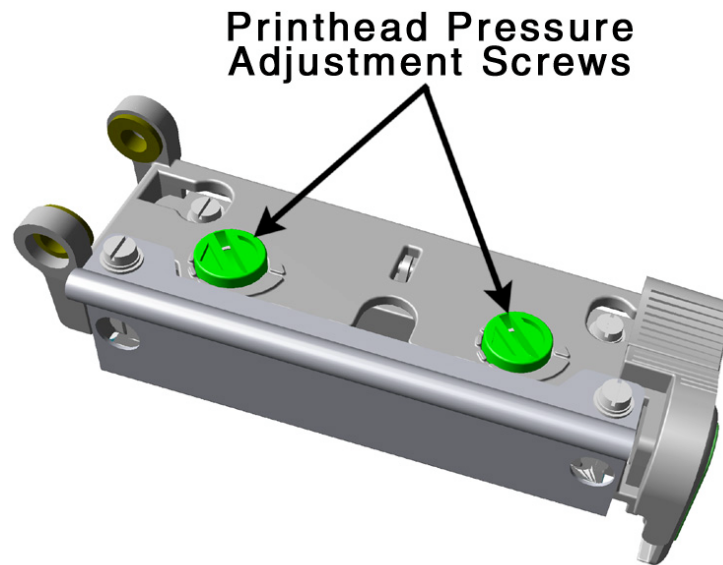

Note: When using narrow media it is sometimes necessary to increase the pressure on the inner (closest to centerplate) Printhead Pressure Adjustment Screw to prevent ribbon smudging.

Note: Excessive pressure can reduce the service life of the printhead and platen roller.
Unequal pressure may cause ribbon and label tracking problems.

5.5 Printhead Replacement

Removal:

Note: Printheads are fragile; use extreme care when handling and never use a sharp object on the surface. If you have questions, contact a qualified technician or Datamax Technical Support before proceeding.

1. Touch a bare metal part of the printer's frame to discharge any static electricity that may be present on your body.
2. Turn 'Off' and unplug the printer. Open the cover; if ribbon is installed, remove it.
3. With the printhead locked in the down position, loosen the Printhead Mounting Screw (it will remain in the assembly).
4. Unlatch the Printhead Assembly. While holding the Printhead, raise the assembly. Disconnect the two cables and then remove the old Printhead.
5. While carefully holding the new Printhead, connect both cables.
6. Position the Printhead onto the Locating Pins in the Printhead Assembly and secure in place with the Printhead Mounting Screw (do not over-tighten).
7. Clean the Printhead (see Section 5.1).
8. Reload ribbon (if removed), lower the printhead assembly, and rotate the printhead latch back, into the locked position.
9. Use the Darkness Adjustment to match the print contrast of the new printhead to that of the old printhead (see Section 5.6).

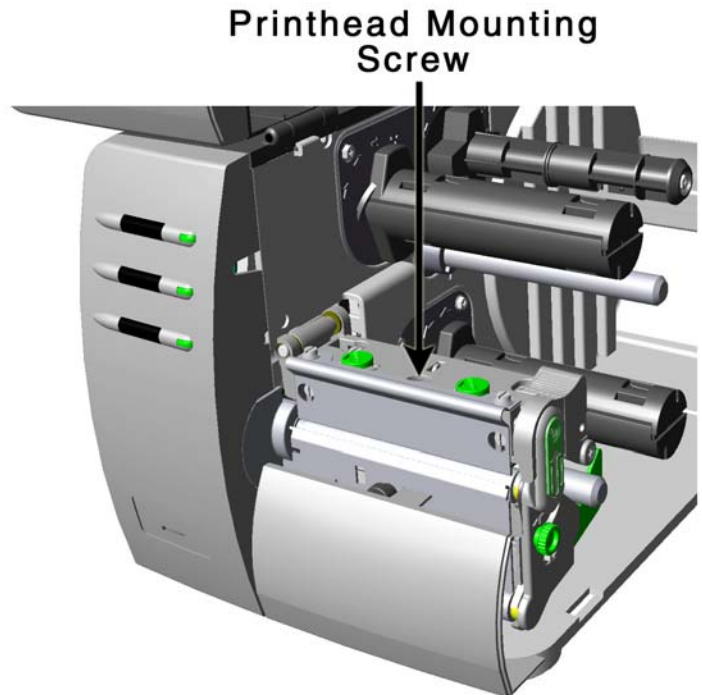

5.6 Darkness Adjustment

The Darkness Adjustment allows the operator to match the print contrast following a printhead replacement. Turning the Darkness Adjustment clockwise will darken the print, while turning it counterclockwise will lighten the print. Compare a label printed with the old printhead and make this adjustment so that the new printhead matches the darkest portion of that label.

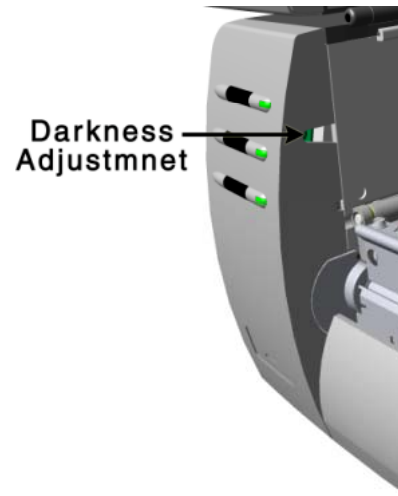

☑ Note: Large increases in the 'Darkness Adjustment' can shorten printhead life. If you need to increase the darkness of the printed labels, try increasing the Heat value and/or slow the Print Speed using your software program or via DPL commands.

5.7 Resetting to the Factory Defaults

With the printer power 'Off,' press and hold all three buttons while turning 'On' the printer. Continue to hold the buttons down until the  STOP light turns off (approximately 17 seconds). The printer will now be set to the 'Factory Defaults.' See Section 4.5.1 for a listing of the factory default settings. Resetting to 'Factory Defaults' will not effect the following settings:

5) SOP ADJUST	12) TOF GAIN
6) PRESENT ADJUST	13) TOF DELTA
11) OOS MAXVOLT	14) TOF LOW





5.8 Downloading Firmware and Fonts

The operating programs and fonts for the printer are stored in Flash memory on the Main PCB. When program updates and/or new features are added, they can be downloaded to the printer as follows:

1. Identify the new version for your model of printer from the Datamax Web site at www.datamaxcorp.com and download it onto your computer's hard drive or a floppy disk.
2. Ensure that the printer is connected to the host, (via parallel port only) and that the power is 'On.' Using the DOS copy command enter:

```
copy filename.dlf lpt1/b
```

Note: Other programs (e.g., hyper-terminal and certain Windows Driver programs) may also be used to download this file.



3. The READY  light will flash during the download.
4. **Following a successful download**, the  STOP Light will illuminate then the printer will perform a 'cold reset.' The previous printer setup will not be affected unless substantial firmware data structure changes have occurred. Print a Database Configuration Label to verify your new firmware version.
 - **Following an unsuccessful download**, the  ERROR Light will illuminate then the printer will perform a 'warm reset' (both the READY  and  STOP lights will be on during power-up initialization). The original firmware will remain operational. If the printer fails to reset, toggle the power 'Off' and 'On.'

Try re-sending the file to the printer. If the failure continues, check the following possible causes:

An invalid or corrupted file is being downloaded - Ensure the file being downloaded is correct and applicable for your printer model.

Possible communications error - Check the cable connection between the host and printer and ensure that a quality, shielded cable is used.

Possible Flash memory problem - Call for service.

If the printer fails to boot-up after an unsuccessful download, turn 'Off' the power. Simultaneously press and hold the  PAUSE +  CANCEL buttons while powering 'On' the printer. Now, try downloading the file to the printer.



Troubleshooting

6.0 Introduction

Occasionally, situations arise that require troubleshooting. Possible problem situations and potential solutions are listed in this section. While not every situation is addressed, you may find some of these tips helpful. After the correction action is taken press the  FEED button to clear the alarm. Contact a qualified service technician for problems that persist or are not covered in this section.

6.1 Troubleshooting Tips

The following table lists the symptoms of the topics covered in the troubleshooting section.

Problem Situation
Unacceptable print quality
The printer does not print or prints several labels at once
The ribbon does not advance
Skips every other label
Unable to print in rotation 4
Prints light on the right side of the label
Printer fails to turn on
Label advances 1-2 inches before a fault indication
Label advances 16 inches before a fault indication
 STOP light flashing
Tracking Problems
Ribbon Smudging with narrow media during label back-feed

Unacceptable print quality

Dirty printhead: Clean the printhead (see Chapter 5).

The temperature setting may be incorrect for the media being used: Use the software program or DPL commands adjust the Heat Setting and Print Speed.

A mismatched incorrect ribbon/media combination is being used: Check the types being used.

Verify that the Media Type is set correctly for the printing method being used (see Chapter 4).

Faulty printhead: Replace it (see Chapter 5) or call for service.

The printer does not print or prints several labels at once:

The labels are incorrectly loaded: See the loading instructions on the inside cover of the printer or Chapter 3.

The media is not calibrated: Calibrate it (see Chapter 4).

The Media Sensor may need to be repositioned (see Chapter 3).

The media sensor or sensor circuitry may be defective: Call for service.

The ribbon does not advance

(The paper advances, but ribbon does not).

The ribbon may be installed incorrectly: Ensure that the ribbon's inked side faces the paper. With most ribbons this can be verified by rubbing paper against the ribbon; the ink should smudge the paper. Or, if using label stock, the sticky side of a label will pull off the ink.

A mismatched ribbon/paper combination is resulting in an insufficient amount of friction between paper and ribbon: Ensure that the correct type of ribbon is being used with the media.

Skips every other label

(Print quality is good, but every other label is skipped).

The label is formatted too close to the top edge of the label: Leave white space equal to 8-dot rows (about .02 inch [.5mm]) at the top of the label.

The media is not calibrated: Calibrate it (see Chapter 4).

The Media Sensor may need to be repositioned (see Chapter 3).

The media sensor or media sensor circuitry may be defective: Call for service.

Unable to print in rotation 4

The characters are formatted outside the dimensions of the label: Check that the row/column values provide enough room for the height of the image being printed.

Prints light on the right side of the label

The media width adjustment is set for a narrower media width than is actually being used: Adjust for the media width (see Chapter 5).

The printhead is not properly aligned: Call for service.

The printhead carrier assembly is not latched down: Latch it.

Printer fails to power on

The AC wall outlet may be faulty: Try another outlet.

A fuse may be blown: Call for service.

The power supply may be faulty: Call for service.

A defective power switch may exist on the printer: Call for service.

Label advances 1-2 inches before a fault indication

The ribbon may be incorrectly installed. Ensure that the ribbon's inked side faces the paper. With most ribbons this can be verified by rubbing paper against the ribbon; the ink should smudge the paper. Or, if using label stock, the sticky side of a label will pull off the ink.

A mismatched ribbon/paper combination is resulting in an insufficient amount of friction between paper and ribbon: Ensure that the correct type of ribbon is being used with the media.

Label advances 16 inches before a fault indication

The media may not be properly loaded: Reload it (see Chapter 3). When loading media ensure that the media hub and media guide are against the media and that gaps or marks in the labels are in line with the media sensor.

The Media Sensor may need to be repositioned (see Chapter 3).

The media sensor or media sensor circuitry may be defective: Call for service.

Ⓢ STOP Light flashing

When the printer is equipped with the Peel and Present Options the Ⓢ STOP light will flash when a label is presented to the operator. This is considered normal.

If the printer is configured to use the Peel and Present option and yet the option is not installed or the option is removed with power on, the Ⓢ STOP light will flash to alert the operator.

Tracking Problems

The media may not be properly loaded: Reload it (see Chapter 3). When loading media ensure that the media hub and media guide are against the media and that gaps or marks in the labels are in line with the media sensor.

The media width adjustment may not be properly set: Readjust for the label width (see Chapter 5).

Ribbon Smudging during label back-feed

When printing with a ribbon, the width of the ribbon must be slightly wider than the label media being used. Ensure the ribbon width is approximately .125" (4mm) to .250" (7mm) wider than the label media.

Increase the inner (closest to centerplate) Printhead Pressure Adjustment Screw counterclockwise to increase the applied pressure (see Chapter 5).



Specifications

Mechanical

Width	9.8" (24.9 cm)
Depth	18.06" (45.9 cm)
Height	10.3" (26.2 cm)
Weight	21.5 lbs. (9.77 kg)
Operating Temperature	40 F to 95 F (4 C to 35 C)
Humidity	10% - 95% non-condensing
AC Input Voltage	90 – 132 or 180 – 264 VAC @ 47–63 Hz, auto-ranging.

Printing

Print Method	Direct Thermal; Thermal Transfer (optional)
Print Speed	2 - 6 IPS (50 - 152 mm/s)
Resolution	203 dpi (8 dots/mm)
Tear Bar	Tear Down
DRAM Memory	4MB
FLASH Memory	2MB

Media/Ribbon

Media Types	Roll-Fed, Die-Cut, Continuous, Fan-Fold
Max. Media Width	4.65" (118 mm)
Min. Media Width	1" (25.4 mm)
Max. Print Width	4.09" (104 mm)
Print Length Range	.25 - 99" (6 - 2475 mm)
Media Thickness Range	.0025 - .01" (.064 mm - .254 mm)
Media Supply Roll Capacity	8" (203 mm) O.D. on 1.5 - 3.0" (38 - 76.2 mm) cores
Ribbon Width Range	1.0 - 4.5" (25 - 114 mm)
Ribbon Roll Capacity	Matched to media: approx. 1476' (450 m) long
Ribbon Core:	1.010" .006" (25.6 mm .2 mm) inner diameter.

Communications

Interface	USB, RS-232 (DB-9), and IEEE 1284 Compliant Centronics Parallel
Baud Speed	600 to 38,400 bits per second (BPS)
Handshaking	Xon/Xoff, CTS, DTR
Parity	Even, Odd, or None
Stop Bits	1 or 2
Data Bits	7 or 8

Fonts

9 Bit Map Fonts; rotated 0, 90, 180, 270 degrees.

Embedded Bar Codes

Code 39, Interleaved 2 of 5, Code 128 A, B & C, Codabar, LOGMARS, UPC-A, UPC-E, UPC 2&5, EAN-8, EAN-13, EAN 2&5, UPC Random Weight, Code 93, Plessey, USCS, Code 128 MOD 43, Postnet, Uss/EAN-128 Random Weight, Telepen, UPS Maxicode, PDF417, DataMatrix, Aztec, QR Code, MicroPDF417, and TLC39

Approved Media

To achieve optimum print quality and maximum printhead life, Datamax specifies the use of *DATAMAX* brand media and ribbons. These supplies are specially formulated for use in our printers; use of non-Datamax supplies may affect the print quality, performance, and life of the printer or its components.

For a current list of approved media and ribbons for use in direct thermal and thermal transfer applications, please contact a Media Representative at (407) 523-5650.

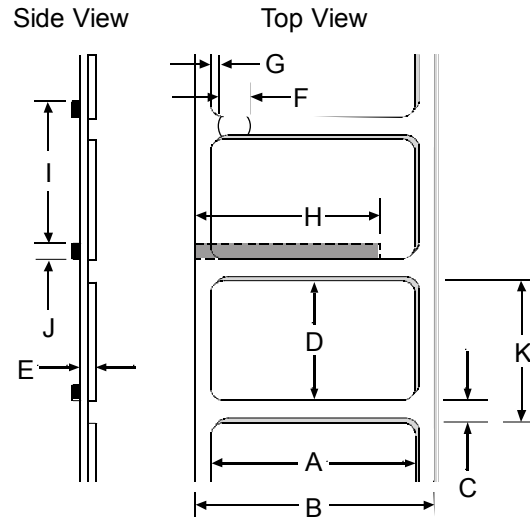

Media Dimensions			
Designator	Description	Maximum ^[1]	Minimum ^[1]
A	label width	4.65	1.00
B	liner width	4.65	1.00
C	gap (or notch) between labels ^[3]	.25	.100
D	label length ^[3]	–	.250
E	media thickness	.0100	.0025
F	notch opening width	.500	.200
G	distance from the media's edge to the media sensor aperture (left justified)	2.250	.200
H	reflective (black) mark width ^[2]	4.65	.500
I	distance between reflective marks ^[3]	–	.500
J	reflective mark length ^[3]	–	.100
K	label repeat distance ^[3]	–	.350

^[1]Units of measure given in inches.

^[2]The reflective (black) mark must be carbon based, placed on the backside of the stock, and the reflectance shall be less than 10% at wavelengths of 950 and 640 nm.

^[3]The maximum allowable length of the combined label and gap (or mark) measurement can not exceed 99.99 inches.



Appendix A

ASCII Control Code Chart

	Char	Dec	Hex	Char	Dec	Hex	Char	Dec	Hex	Char	Dec	Hex
Ctrl @	NUL	0	00		32	20	@	64	40	`	96	60
Ctrl A	SOH	1	01	!	33	21	A	65	41	a	97	61
Ctrl B	STX	2	02	“	34	22	B	66	42	b	98	62
Ctrl C	EXT	3	03	#	35	23	C	67	43	c	99	63
Ctrl D	EOT	4	04	\$	36	24	D	68	44	d	100	64
Ctrl E	ENQ	5	05	%	37	25	E	69	45	e	101	65
Ctrl F	ACK	6	06	&	38	26	F	70	46	f	102	66
Ctrl G	BEL	7	07	‘	39	27	G	71	47	g	103	67
Ctrl H	BS	8	08	(40	28	H	72	48	h	104	68
Ctrl I	HT	9	09)	41	29	I	73	49	i	105	69
Ctrl J	LF	10	0A	*	42	2A	J	74	4A	j	106	6A
Ctrl K	VT	11	0B	+	43	2B	K	75	4B	k	107	6B
Ctrl L	FF	12	0C	,	44	2C	L	76	4C	l	108	6C
Ctrl M	CR	13	0D	-	45	2D	M	77	4D	m	109	6D
Ctrl N	SO	14	0E	.	46	2E	N	78	4E	n	110	6E
Ctrl O	SI	15	0F	/	47	2F	O	79	4F	o	111	6F
Ctrl P	DLE	16	10	0	48	30	P	80	50	p	112	70
Ctrl Q	DC1	17	11	1	49	31	Q	81	51	q	113	71
Ctrl R	DC2	18	12	2	50	32	R	82	52	r	114	72
Ctrl S	DC3	19	13	3	51	33	S	83	53	s	115	73
Ctrl T	DC4	20	14	4	52	34	T	84	54	t	116	74
Ctrl U	NAK	21	15	5	53	35	U	85	55	u	117	75
Ctrl V	SYN	22	16	6	54	36	V	86	56	v	118	76
Ctrl W	ETB	23	17	7	55	37	W	87	57	w	119	77
Ctrl X	CAN	24	18	8	56	38	X	88	58	x	120	78
Ctrl Y	EM	25	19	9	57	39	Y	89	59	y	121	79
Ctrl Z	SUB	26	1A	:	58	3A	Z	90	5A	z	122	7A
Ctrl [Esc	27	1B	;	59	3B	[91	5B	{	123	7B
Ctrl \	FS	28	1C	<	60	3C	\	92	5C		124	7C
Ctrl]	GS	29	1D	=	61	3D]	93	5D	}	125	7D
Ctrl ^	RS	30	1E	>	62	3E	^	94	5E	~	126	7E
Ctrl _	US	31	1F	?	63	3F	_	95	5F		127	7F

Char	Dec	Hex	Char	Dec	Hex	Char	Dec	Hex	Char	Dec	Hex
Ç	128	80	á	160	A0		192	C0	Ó	224	E0
ü	129	81	í	161	A1		193	C1	ß	225	E1
é	130	82	ó	162	A2		194	C2	Ô	226	E2
â	131	83	ú	163	A3		195	C3	Ò	227	E3
ä	132	84	ñ	164	A4		196	C4	ö	228	E4
à	133	85	Ñ	165	A5		197	C5	Õ	229	E5
ã	134	86	a	166	A6	ã	198	C6	µ	230	E6
ç	135	87	°	167	A7	Ã	199	C7	ρ	231	E7
ê	136	88	¿	168	A8		200	C8	ρ	232	E8
è	137	89	®	169	A9		201	C9	Ú	233	E9
è	138	8A		170	AA		202	CA	Û	234	EA
ï	139	8B	1/2	171	AB		203	CB	Ü	235	EB
î	140	8C	1/4	172	AC		204	CC	ý	236	EC
ì	141	8D	ì	173	AD		205	CD	ÿ	237	ED
Ä	142	8E		174	AE		206	CE		238	EE
Å	143	8F	–	175	AF		207	CF		239	EF
É	144	90		176	B0	Ò	208	D0		240	F0
Æ	145	91		177	B1	Ɔ	209	D1	±	241	F1
Æ	146	92	2	178	B2	È	210	D2		242	F2
ô	147	93	3	179	B3	Ë	211	D3	3/4	243	F3
ö	148	94	´	180	B4	Ë	212	D4		244	F4
ò	149	95	Á	181	B5		213	D5		245	F5
û	150	96	Â	182	B6	Í	214	D6	÷	246	F6
ù	151	97	À	183	B7	Î	215	D7	,	247	F7
ÿ	152	98	©	184	B8	Ï	216	D8	°	248	F8
Ö	153	99	1	185	B9		217	D9	¨	249	F9
Û	154	9A		186	BA		218	DA	·	250	FA
Ø	155	9B	»	187	BB		219	DB		251	FB
£	156	9C		188	BC		220	DC		252	FC
Ø	157	9D	¢	189	BD		221	DD		253	FD
x	158	9E	¥	190	BE	ì	222	DE		254	FE
f	159	9F		191	BF		223	DF	€	255	FF

Notes: For the hardware handshake XON/XOFF commands:

XON = Ctrl Q (DC1)

XOFF = Ctrl S (DC3)

The Euro € character has been added to the table above at 255 (FF) as a Datamax standard for resident bit-mapped fonts 0,1,2,3,4,5,6, and 9 (CG Triumvirate).



Appendix B

Embedded Fonts and Barcodes

All character fonts and barcodes available with the printer are described in this section. Each font and barcode has a name associated with it for use in programming. Human-readable fonts have numeric names while barcode fonts have alpha names.

Fonts

Fonts 0 through 8 use the slash zero (Ø) conventions for distinguishing between the zero and the alphabetic O. The slash can be removed with the label formatting command Z. These fonts are non-proportional (monospaced): all of the characters take up the same amount of space when printed.

The Triumvirate font number 9 is a proportional font; each character will take up a different amount of space when printed.

Font	Valid ASCII Characters (decimal)	Use with Record Structure Type
0	32-127,255	Internal Bit-Mapped Fonts
1	32-168, 171, 172, 225,255	
2	32-168, 171, 172, 225,255	
3	32, 35-38, 40-58, 65-90, 128, 142-144, 146, 153, 154, 156, 157, 165, 168, 225,255	
4	32, 35-38, 40-58, 65-90, 128, 142-144, 146, 153, 154, 156, 157, 165, 168, 225,255	
5	32, 35-38, 40-58, 65-90, 128, 142-144, 146, 153, 154, 156, 157, 165, 168, 225,255	
6	32, 35-38, 40-58, 65-90, 128, 142-144, 146, 153, 154, 156, 157, 165, 168, 225,255	
7	32-126	
8	32, 48-57, 60, 62, 67, 69, 78, 83, 84, 88, 90	
9	32-126, 128-169, 171-173, 181-184, 189, 190, 198, 199, 208-216, 222, 224-237, 241, 243, 246-250,255	Smooth Font
9	Dependent upon selected symbol set; see the Programmers Manual.	Downloadable Scalable Font

The table below lists the font sizes. The numbers indicate the number of dots.

FONT	HEIGHT	WIDTH	SPACING
Font 0	7	5	1
Font 1	13	7	2
Font 2	18	10	2
Font 3	27	14	2
Font 4	36	18	3
Font 5	52	18	3
Font 6	64	32	4
Font 7	32	15	5
Font 8	28	15	5

Font 0 96-character alphanumeric, upper and lower case.

```
Font 0
!"#$%&'()*+,-./0123456789:;<=>?@
ABCDEFGHIJKLMNOPQRSTUVWXYZ[\]^_`
abcdefghijklmnopqrstuvwxyz{|}~
!@#%&'()*+,-./0123456789:;<=>?@
```

Font 1 145-character upper and lower case alphanumeric w/ descenders and ascenders.

```
Font 1:
!"#$%&'()*+,-./0123456789:;<=>?@
ABCDEFGHIJKLMNOPQRSTUVWXYZ[\]^_`
abcdefghijklmnopqrstuvwxyz{|}~
ÇüéàáâãäåæçèéëìíîËÆøffóó
ûüÿÜöø£Ø×fa iouñÑªº¼½¾
```

Font 2 138-character alphanumeric, upper and lower case.

```
Font 2:
!"#$%&'()*+,-./0123456789:;<=>?@
ABCDEFGHIJKLMNOPQRSTUVWXYZ[\]^_`
abcdefghijklmnopqrstuvwxyz{|}~
ÇüéàáâãäåæçèéëìíîËÆøffóó
ûüÿÜöø£Ø×fa iouñÑªº¼½¾
```

Font 3 62-character alphanumeric, uppercase.

```
FONT 3:
!"#$%&'()*+,-./0123456789:
ABCDEFGHIJKLMNOPQRSTUVWXYZ
ÇAÆËÖÜ£ØÑ½¾
```

Font 4 62-character
alphanumeric, uppercase.

FONT 4:
\$ % & () * + . - / 0 1 2 3 4 5 6 7 8 9 :
A B C D E F G H I J K L M N O P Q R S T U V W X Y Z
Ç Ä Å Æ Ö Ù £ Ø Ñ Ò Ó

Font 5 62-character
alphanumeric, uppercase.

FONT 5:
\$ % & () * + . - / 0 1 2 3 4 5 6 7 8 9 :
A B C D E F G H I J K L M N O P Q R S T U V W X Y Z
Ç Ä Å Æ Ö Ù £ Ø Ñ Ò Ó

Font 6 62-character alphanumeric, uppercase.

FONT 6:
\$ % & () * + . - /
0 1 2 3 4 5 6 7 8 9 :
A B C D E F G H I J K L
M N O P Q R S T U V W X Y Z
Ç Ä Å Æ Ö Ù £ Ø Ñ Ò Ó

Font 7 OCR-A, size I.

Font 7:
! " # \$ % & ' () * + , - . /
0 1 2 3 4 5 6 7 8 9 : ; < = > ? @
A B C D E F G H I J K L M N O
P Q R S T U V W X Y Z [\] ^ _ `
a b c d e f g h i j k l m n o
p q r s t u v w x y z { | } ~ ¯

Font 8 OCR-B, size III.

Font 8:
0 1 2 3 4 5 6 7 8 9
< > C E N S T X Z |

Font 9 Internal Triumvirate font.

Point sizes are selected by the number in the barcode height.
Larger point sizes can be obtained by increasing the height and width multipliers, 48pt and 72pt fonts are generated by doubling the 24pt and 36pt fonts respectively (see the *Programmer's Manual* for more information).

6 pt ABCDEFGHIJKLMNOPQRSTUVWXYZabcdefghijklmnopqrstuvwxyz0123456789
8 pt ABCDEFGHIJKLMNOPQRSTUVWXYZabcdefghijklmnopqrstuvwxyz
10 pt ABCDEFGHIJKLMNOPQRSTUVWXYZabcdefghijklmnopqrstu
12 pt ABCDEFGHIJKLMNOPQRSTUVWXYZabcdefghijklmnopqr
14 pt ABCDEFGHIJKLMNOPQRSTUVWXYZabcdefghijklmnopqr
18 pt ABCDEFGHIJKLMNOPQRSTUVWXYZabcdefghijklmnopqr
24 pt ABCDEFGHIJKLMNOPQRSTUVWXYZabcdefghijklmnopqr
30 pt ABCDEFGHIJKLMNOPQRSTUVWXYZabcdefghijklmnopqr
36 pt ABCDEFGHIJKLMNOPQRSTUVWXYZabcdefghijklmnopqr
48 pt ABCDEFGHIJKLMNOPQRSTUVWXYZabcdefghijklmnopqr

Barcodes

Bar Code fonts have alpha names (left column in the table below). Uppercase alpha names will print barcodes with human-readable interpretations. Lowercase alpha names will print barcodes only. The table is followed by visual samples.

Bar Code ID	Type	Length	Check-sum	Valid ASCII Characters, decimal value representation
A / a	Code 3 of 9	Varies	No	32, 36, 37, 42, 43, 45-57, 65-90
B / b	UPC-A	11	Yes	48-57 Numeric only Option V used in the 6th & 7th position
C / c	UPC-E	6	Yes	48-57 Numeric only
D / d	Interleaved 2 of 5 (1 2 of 5)	Varies	No	48-57 Numeric only
E / e	Code 128	Varies	M-103	32-127
F / f	EAN-13	12	Yes	48-57 Numeric only. Option V used in the 7th & 8th position
G / g	EAN-8	7	Yes	48-57 Numeric only
H / h	Health Industry Bar Code	Varies	M-43	32, 36-39, 42, 43, 45-57, 65-90
I / i	Codabar	Varies	No	36, 43, 45-58, 65-68
J / j	1 2 of 5 with modulo 10 checksum	Varies	M-10	48-57 Numeric only
K / k	Plessey	Up to 14	M-10	48-57 Numeric only. Option + is Last Character for Second M-11 checksum
L / l	1 2 of 5 with modulo 10 checksum & bearer bars	13	M-10	48-57 Numeric only
M / m	2 digit UPC addendum	2	Yes	48-57 Numeric only
N / n	5 digit UPC addendum	5	Yes	48-57 Numeric only
O / o	Code 93	Varies	No	35-38, 42-58, 65-90, 97-122
p	Postnet	Varies	Yes	48-57 Numeric only
Q / q	UCC/EAN Code 128	19	Yes	48-57 Numeric only
R / r	UCC/EAN Code 128 K-Mart NON EDI bar code	18	Yes	48-57 Numeric only
S / s	UCC/EAN Code 128 Random Weight	34 +	Yes	48-57 Numeric only
T / t	Telepen	Varies	Yes	Alphanumeric
U	UPS MaxiCode	84	Yes	Alphanumeric

Bar Code ID	Type	Length	Check-sum	Valid ASCII Characters, decimal value representation
u	UPS MaxiCode with Byte Count	Specified	Yes	Alphanumeric
v	FIM	1	No	A, B, C, D
z	PDF417	Varies	Yes	All
Z	PDF417 with Byte Count	Specified	Yes	All
W1c	DataMatrix	Varies	Yes	All 8-bit values
W1C	DataMatrix with Byte Count	Specified	Yes	All 8-bit values
W1d	QR Code – Auto format	Varies	Yes	Alphanumeric
W1D	QR Code – Manual format	Varies	Yes	Single-byte or Kanji double-byte
W1f	Aztec	Varies	Yes	All 8-bit values
W1F	Aztec with Byte Count	Specified	Yes	All 8-bit values
W1T	TCIF Linked Barcode 3 of 9 (TLC39)	Varies	No	Alphanumeric
W1z	MicroPDF417	Varies	Yes	All 8-bit values
W1Z	MicroPDF417 with Byte Count	Specified	Yes	All 8-bit values

Barcode A Code 3 of 9



Barcode B UPC-A



Barcode C UPC-E



Barcode D Interleaved 2 of 5



Barcode E Code 128



Barcode F EAN-13



Barcode G EAN-8



Barcode H Health Industry
Barcode (HIBC)



Barcode I Codabar



Barcode J Interleaved 2 of 5
w/module 10 checksum



Barcode K Plessey



Barcode L Interleaved 2 of 5
w/module 10 checksum and
shipping bearer bars



Barcode M 2 Digit UPC
addendum



Barcode N 5 Digit UPC
addendum

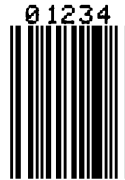

Barcode O Code 93



Barcode p Postnet



Barcode Q UCC/EAN Code 128

Barcode R UCC/EAN Code 128
KMART NON EDI

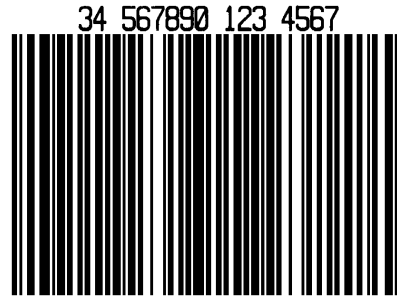

Barcode S UCC/EAN Code 128 Random Weight

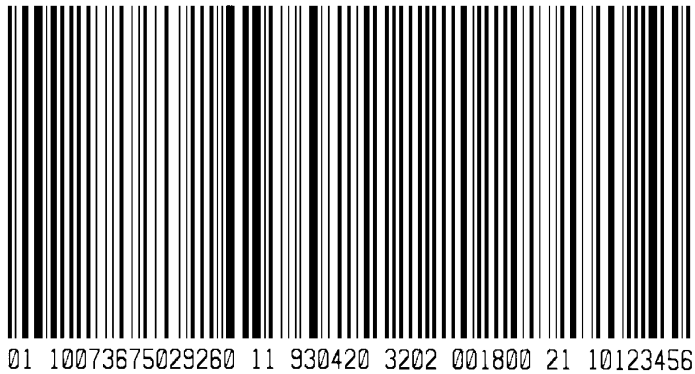

Barcode T Telepen



Barcode u UPS MaxiCode

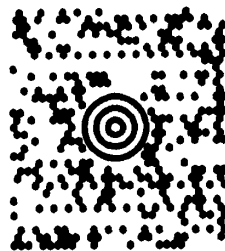

Barcode v FIM

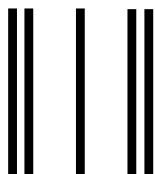

Barcode z PDF417



Bar Code W1c: DataMatrix



Bar Code W1d: QR Code



Bar Code W1f: Aztec



Bar Code W1z: MicroPDF417



Bar Code W1T: TCIF Linked Barcode 3 of 9 (TLC39)





Appendix C

Datamax Barcode Products Limited Warranty Statement

M-Class™ Printer

Printer

Datamax warrants to Purchaser that under normal use and service, the M-Class™ Printer, (with the exception of the thermal printhead) purchased hereunder shall be free from defects in material and workmanship for a period of (365) days from the date of shipment by Datamax.

Expendable and/or consumable items or parts such as lamps, fuses, labels and ribbons are not covered under this warranty. This warranty does not cover equipment or parts which have been misused, altered, neglected, handled carelessly, or used for purposes other than those for which they were manufactured. This warranty also does not cover loss, damages resulting from accident, or damages resulting from unauthorized service.

Thermal Printhead

This warranty is limited to a period of one year, (365 days), or 1,000,000 linear inches of use, whichever comes first, for the M-Class™ thermal printhead. This one year (365 days) warranty is valid only if a Datamax - approved thermal label media is used, as defined in the then current Datamax list of approved thermal/thermal transfer media, a copy of which is available from Datamax. Failure to use Datamax-approved media is justification for invalidation of this thermal printhead warranty. This warranty does not cover printheads which have been misused, altered, neglected, handled carelessly, or damaged due to improper cleaning or unauthorized repairs.

Warranty Service Procedures

If a defect should occur during the warranty period, the defective unit shall be returned, freight and insurance prepaid, in the original shipping containers, to Datamax at: 4501 Parkway Commerce Blvd., Orlando, Florida, 32808. A Return Material Authorization (RMA) number must be issued before the product can be returned. To open an RMA please call the Datamax Customer Service Department at (407) 523-5550. Please include your RMA number on the outside of the box and on the shipping document. Include a contact name, action desired, a detailed description of the problem(s), and examples when possible with the defective unit. Datamax shall not be responsible for any loss or damages incurred in shipping. Any warranty work to be performed by Datamax shall be subject to Datamax's confirmation that such product meets Datamax warranty. In the event of a defect covered by its warranty, Datamax will return the repaired or replaced product to the Purchaser at Datamax's cost.

With respect to a defect in hardware covered by the warranty, the warranty shall continue in effect until the end of the original warranty period, or for sixty (60) days after the repair or replacement, whichever is later.

General Warranty Provisions

Datamax makes no warranty as to the design, capability, capacity or suitability of any of its hardware, supplies, or software.

Software is licensed on an "as is" basis without warranty. Except and to the extent expressly provided in this warranty and in lieu of all other warranties, there are no warranties, expressed or implied, including, but not limited to, any warranties of merchantability or fitness for a particular purpose.

Purchaser shall be solely responsible for the selection, use, efficiency and suitability of Datamax's products.

Limitation of Liability

In no event shall Datamax be liable to the purchaser for any indirect, special or consequential damages or lost profits arising out of or relating to Datamax's products, or the performance or a breach thereof, even if Datamax has been advised of the possibility thereof. Datamax's liability, if any, to the purchaser or to the customer of the purchaser hereunder shall in no event exceed the total amounts paid to Datamax hereunder by the purchaser for a defective product.

In no event shall Datamax be liable to the purchaser for any damages resulting from or related to any failure or delay of Datamax in the delivery or installation of the computer hardware, supplies or software or in the performance of any services.

Some states do not permit the exclusion of incidental or consequential damages, and in those states the foregoing limitations may not apply. The warranties here give you specific legal rights, and you may have other legal rights which vary from state to state.



Glossary

alphanumeric Consisting of alphabetic, numeric, punctuation and other symbols.

backing material The silicon-coated paper carrier material to which labels with adhesive backing are affixed. Also referred to as “liner”.

bar code A representation of alphanumeric information in a pattern of machine-readable marks. The basic categories are divided into one-dimensional (UPC, Code 39, Postnet, etc.) and two-dimensional barcodes (DataMatrix, MaxiCode, PDF417, etc.).

burn line The row of thermal elements in the printhead that create the images on the media.

calibration The process through which sensor readings are entered into the printer for correct sensor function (for example, detection of a given media type) and TOF positioning.

character set The entire complement of alphanumeric symbols contained in a given font.

checksum An alphanumeric error detection method used in many bar code symbologies for informational security.

continuous media An uninterrupted roll or box of label or tag media that contains no gap, notch, or mark to separate individual labels or tags.

core diameter The inside diameter measurement of the cardboard core at the center of a ribbon or media roll.

cutter A mechanical device with a rotary or guillotine type blade used to cut labels or tags following printing.

defaults The functional setting values returned following a factory reset of the printer.

diagnostics Programs used to locate and diagnose hardware problems.

die-cut media Media that has been cut into a pattern using a press, where the excess paper is removed leaving individual labels, with gaps between them, attached to a backing material.

direct thermal The printing method that uses a heat sensitive media and only the heat of the thermal printhead to create an image on the label.

direct thermal media Media coated with special chemicals that react and darken with the application of heat.

DPI (dots per inch) A measurement of print resolution, rated in the number of thermal elements contained in one inch of the printhead. Also referred to as “resolution”.

DPL (Datamax Programming Language) programming commands used specifically for control of and label production in Datamax printers. A complete listing of commands can be found in the *Programmer’s Manual*.

fan-fold Media that is folded and stacked.

feed speed The speed at which the media moves under the printhead in non-printed areas and between labels.

Flash memory Non-volatile memory (does not require printer power to maintain data) that can be erased and reprogrammed, used to hold the printer’s operating programs.

font A set of alphanumeric characters that share a particular typeface.

gap A space between die-cut or notched labels used to sense the top of form.

IPS (inches per second) Imperial measurement of printer speeds.

label A paper or synthetic printing material, typically with a pressure sensitive adhesive backing.

label length The distance from the top of the label to the bottom of the label as it exits the printer.

label repeat The distance from the top of one label to the top of the next label.

label tracking Excessive lateral (side to side) movement of the media as it travels under the printhead.

label width The left to right measurement of the label as it exits the printer.

mark Generalized term to indicate the label top of form light.

media Generalized term for all types of printing stocks, including: roll fed, continuous, die-cut, reflective, and fanfold.

media hub Device in the printer used to support roll media.

media sensor An electronic device equipped with photosensors to detect media and the top of form on die-cut, notched or reflective media.

notched stock Media, typically tag stock, with holes or notches in the material that is used to signal the top of form. The printer must be set to 'gap' to use this media type.

preprinted media Label stock that contains borders, text, or graphics, floodcoating, etc.

perforation Small cuts extending through the backing and/or label material to facilitate their separation. Also referred to as "perf".

print speed The speed at which the media moves under the printhead during the printing process.

reflective media Media imprinted with carbon-based black marks on the underside of the material, which is used to signal the top of form when the 'reflective' sensor is enabled.

registration Repeatable top to bottom alignment of printed labels.

reverse speed The backward rate of media motion into the printer during tear-off, peel and present and cutting operations for positioning the label at the start of print position.

ribbon An extruded polyester tape with several layers of material, one of which is ink-like, used to produce an image on the label. Also referred to as "foil".

ribbon wrinkle An undesirable overlapping of the ribbon during the printing process that leads to voids on the printed label, typically caused by an improper ribbon width adjustment.

roll media A form of media that is wound upon a cardboard core.

start of print The position on the label where the printing actually begins.

tag stock A heavy paper or synthetic printing material, typically featuring a notch or black mark for TOF and no adhesive backing.

thermal transfer The printing method that creates an image by transferring ink from a ribbon onto the media using the heat from the thermal printhead.

TOF (top of form) The start of a new label as indicated by a label gap, notch, mark or programming.

void An undesirable blank space in a printed image.

Free Manuals Download Website

<http://myh66.com>

<http://usermanuals.us>

<http://www.somanuals.com>

<http://www.4manuals.cc>

<http://www.manual-lib.com>

<http://www.404manual.com>

<http://www.luxmanual.com>

<http://aubethermostatmanual.com>

Golf course search by state

<http://golfingnear.com>

Email search by domain

<http://emailbydomain.com>

Auto manuals search

<http://auto.somanuals.com>

TV manuals search

<http://tv.somanuals.com>