



DEFY

You can rely on Defy. To simplify

OWNER'S MANUAL

**MODELS
DGS 125 AND DGS 126**

Gas Stove



Permit Number 000 000

Part No. 067796

Please register your product
at
www.defy.co.za

Please read this manual first.

Dear Customer,

We would like you to obtain best performance with your product that has been manufactured in modern facilities and passed through strict quality control procedures.

Therefore, we advise you to read through this User Manual carefully before using your product and keep it for future reference. If you hand over the product to someone else, deliver the User Manual as well.

The User Manual will help you use the product in a fast and safe way.

- Read the User Manual before installing and starting the product.
 - You must strictly observe the safety instructions.
 - Keep this User Manual within easy reach for future reference.
 - Also read other documents supplied with the product.
- Remember that this User Manual may also be applicable for several other models.
Differences between models are explicitly identified in the manual.

Explanation of symbols

Throughout this User Manual the following symbols are used:

 Important information or useful hints about usage.

 Warning for hazardous situations with regard to life and property.

 Warning for electric shock.

 Warning for risk of fire.

 Warning for hot surfaces.

Table of Contents

1	General information	4	5	How to use the hob	19
	Overview	4		General information about cooking	19
	Technical specifications	5		Using the hobs.....	19
	Accessories supplied with the unit	6	6	How to operate the oven	21
	Injector table.....	7		General information on baking, roasting and grilling	21
2	Safety instructions	8		How to use the electric oven	21
	General safety.....	8		Operating modes.....	22
	Safety when working with electricity.	9		How to operate the oven timer.....	23
	Safety when working with gas	9		How to use the alarm clock.....	24
	Intended use	10		Cooking times table.....	25
	Safety for children	10		Other functions.....	27
3	Installation	11		How to operate the grill	27
	Before installation.....	11		Cooking times table for grilling.....	27
	Installation and connection.....	12	7	Maintenance and care	28
	Gas conversion.....	14		General information	28
	Disposal.....	16		Cleaning the hob.....	28
	Disposing of packaging material.....	16		Cleaning the control panel.....	28
	Disposing of the old product.....	16		Cleaning the oven	28
	Future Transportation.....	16		Removal of oven door.....	29
				Replacing the oven lamp	29
4	Preparation	17	8	Troubleshooting	30
	Tips for saving energy	17			
	Initial operation	17	9	Safety compliance with local requirements	32
	Setting the time	17			
	First cleaning of the appliance	18	10	Cleaning the gas jets	33
	Initial heating	18			
			11	Defy Service Centres	33
			12	Warranty	35
			13	Installer's details	36
				Purchase details	36

1 General information

Overview

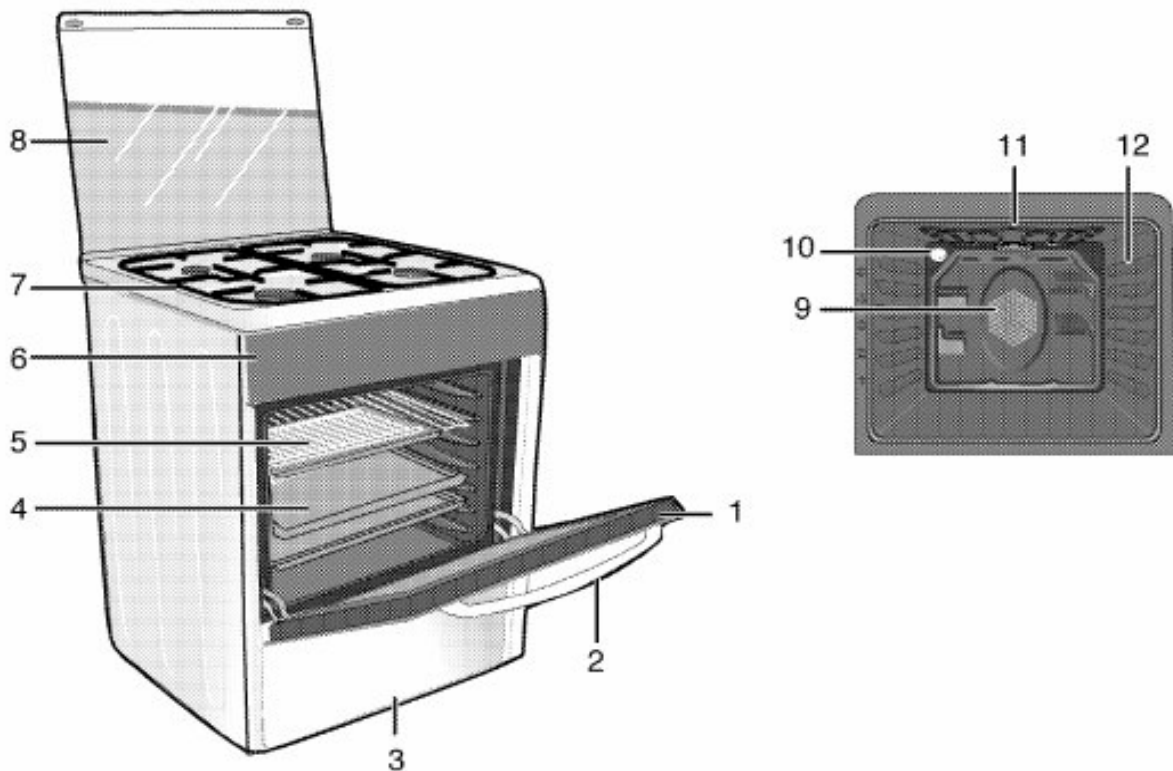

- | | | | |
|---|---------------|----|--------------------------------|
| 1 | Front door | 7 | Burners' plate |
| 2 | Handle | 8 | Top lid |
| 3 | Bottom drawer | 9 | Fan motor (behind steel plate) |
| 4 | Tray | 10 | Lamp |
| 5 | Wire shelf | 11 | Grill heating element |
| 6 | Control panel | 12 | Shelf positions |

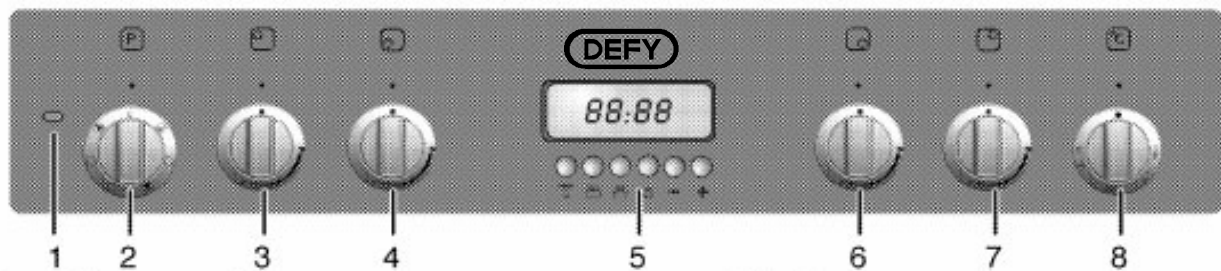

- | | | | |
|---|-------------------------|---|------------------------------|
| 1 | Thermostat lamp | 5 | Digital timer |
| 2 | Function knob | 6 | Auxiliary burner Front right |
| 3 | Normal burner Rear left | 7 | Normal burner Rear right |
| 4 | Rapid burner Front left | 8 | Thermostat knob |

Technical specifications

GENERAL	
External dimensions (height / width / depth)	850 mm/600 mm/600 mm
Voltage / frequency	220-240 V ~ 50 Hz
Total power consumption	2.4 kW
Fuse	min. 16 A
Cable type / section	H05VV-FG 3 x 1,5 mm ²
Cable length	max. 2 m
Gas type / pressure	LPG G 30/28-30 mbar
Total gas consumption	7.9 kW
Converting the gas type / pressure [§] – optional	NG G 20/20 mbar
HOB	
Burners	
Rear left	Normal burner
Power	2000 W
Front left	Rapid burner
Power	2900 W
Front right	Auxiliary burner
Power	1000 W
Rear right	Normal burner
Power	2000 W
OVEN/GRILL	
Main oven	Fan assisted
Energy efficiency class [#]	A
Inner lamp	15–25 W
Grill power consumption	2.2 kW

[#] Basics: Information on the energy label of electrical ovens is given in accordance with the EN 50304 standard. Those values are determined under standard load with bottom-top heater or fan assisted heating (if any) functions.

Energy efficiency class is determined in accordance with the following prioritization depending on whether the relevant functions exist on the product or not. 1-Cooking with eco-fan, 2- Turbo slow cooking, 3- Turbo cooking, 4- Fan assisted bottom/top heating, 5-Top and bottom heating.

^{**} See. *Installation*, page 11.

i Technical specifications may be changed without prior notice to improve the quality of the product.

i Figures in this manual are schematic and may not exactly match your product.

i Values stated on the product labels or in the documentation accompanying it are obtained in laboratory conditions in accordance with relevant standards. Depending on operational and environmental conditions of the product, these values may vary.

Accessories supplied with the unit

i Accessories supplied can vary depending on the product model. All the accessories described in the user manual may not exist on your product.

Baking tray

Can be used for pastries, frozen foods and big roasts.

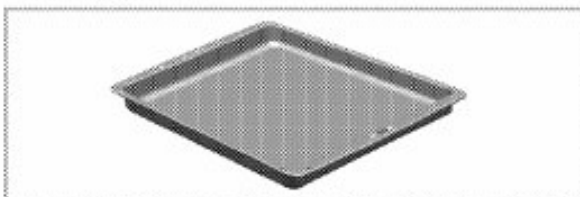

Deep roasting tray

Can be used for pastries, big roasts, foods with liquid content and during grilling as dripping pan.



Pastry tray

It is recommended for pastries such as cookies and biscuits.



Small baking tray

Can be used for small portions. This baking tray is placed onto the wire shelf.

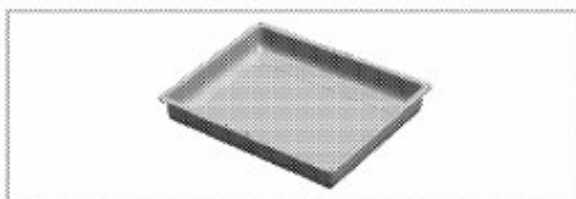

Wire shelf

Can be used for roasting and as deposit for baking, roasting and casserole dishes.

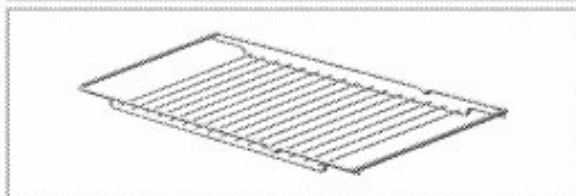
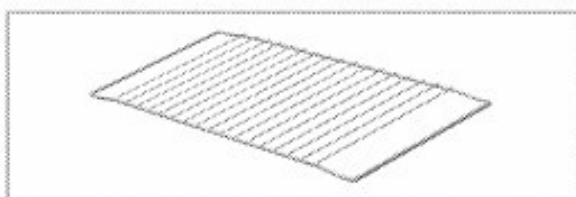

Proper positioning of the wire shelf and tray on sliding shelves

Trays and wire shelves used with the sliding shelf (model dependant) must be positioned correctly with the inner edges of the shelf placed over the pins on the sliding shelf. This holds the shelf firmly in place".

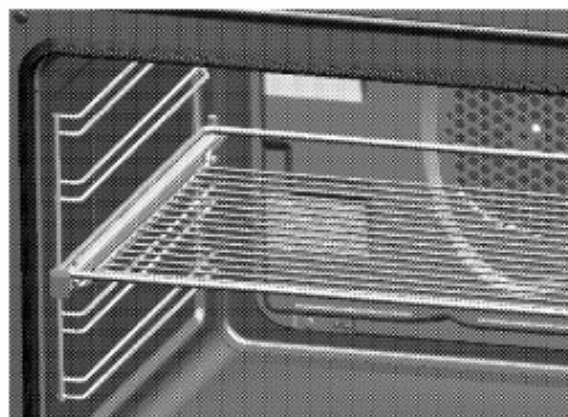
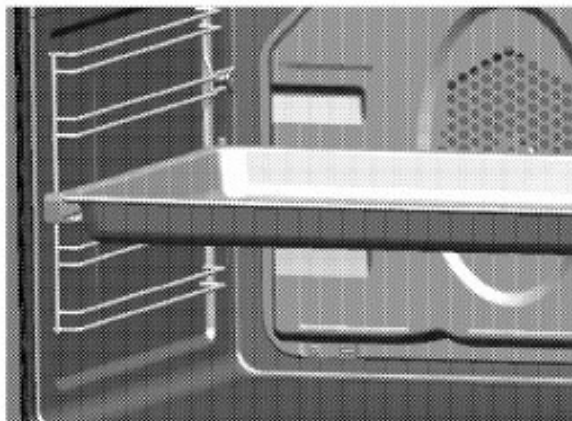

Injector table

Position hob zone	2000 W Rear left	2900 W Front left	1000 W Front right	2000 W Rear right
Gas type / Gas pressure				
G 20/20 mbar	103	115	72	103
G 30/28-30 mbar	72	87	50	72

2 Safety instructions

General safety

- This product is not intended to be used by persons with physical, sensory or mental disorders or unlearned or inexperienced people (including children) unless they are attended by a person who will be responsible for their safety or who will instruct them accordingly for use of the product.
Children must be supervised to prevent them from tampering with the product.
- Connect the product to a grounded outlet/line protected by a fuse of suitable capacity as stated in the "Technical specifications" table. Have the grounding installation made by a qualified electrician while using the product with or without a transformer. Our company shall not be liable for any damages that will arise due to using the product without a grounding installation in accordance with the local regulations.
- Do not operate the product if the power cable or plug is damaged. Call Authorised Service Agent.
- Do not operate the product if it is defective or has any visible damage.
- Do not carry out any repairs or modifications on the product. However, you may remedy some troubles that do not require any repairs or modifications. See *Troubleshooting, page 30*.
- Never wash down the product with water! There is the risk of electric shock!
- Never use the product when your judgement or coordination is impaired by the use of alcohol and/or drugs.
- Product must be disconnected from the mains during installation, maintenance, cleaning and repair procedures.
- Installation and repair procedures must always be performed by Authorised Service Agents. Manufacturer shall not be held responsible for damages arising from procedures carried out by unauthorised persons and may void the warranty.
- Be careful when using alcoholic drinks in your dishes. Alcohol evaporates at high temperatures and may cause fire since it can ignite when it comes into contact with hot surfaces.
- Do not heat closed tins and glass jars in the oven. The pressure that would build-up in the jar may cause it to burst out.
- Do not place any flammable materials close to the product as the sides become hot during use.
- Do not place baking trays, dishes or aluminium foil directly onto the bottom of the oven. The heat accumulation might damage the bottom of the oven.
- Keep all ventilation slots clear of obstructions.
- Product may be hot when it is in use. Never touch the hot burners, the oven interior, elements etc.

Safety instructions.

- Always use heat resistant oven gloves when putting and removing dishes into/from the hot oven.
 - Do not use the product with front door glass removed or cracked.
 - Rear surface of the oven gets hot when it is in use. Make sure that the gas/electrical connection do not contact the rear surface; otherwise, connections can get damaged.
 - Do not trap the mains cable between the oven door and frame and do not route it over the hot surfaces. Otherwise, cable insulation may melt and cause fire as a result of short circuit.
 - Make sure that the product is switched off after every use.
 - Do not close the top cover before the hotplates or burners cool down. Wipe the top cover dry before opening it in order to avoid water leakage to the rear and inner sections of the oven.
-  Product must be installed by a qualified person in accordance with the regulations in force. Otherwise, the warranty shall become void.

Safety when working with electricity

- Any work on electric equipment and systems may only be carried out by authorized qualified persons.
- In case of any damage, switch off the appliance and disconnect it from the mains supply by

removing the fuse or switching off the circuit breaker.

- Ensure that the fuse rating is correct.

Safety when working with gas

- Any works on gas equipment and systems may only be carried out by authorised qualified persons who are Gas Safe registered.
- "Prior to the installation, ensure that the local distribution conditions (nature of the gas and gas pressure) and the adjustment of the appliance are compatible."
- "This appliance is not connected to a combustion products evacuation device. It shall be installed and connected in accordance with current installation regulations. Particular attention shall be given to the relevant requirements regarding ventilation;" See *Before installation, page 11*
- "**CAUTION:**"The use of a gas cooking appliance results in the production of !heat, moisture and products of combustion" in the room in which it is installed. Ensure that the kitchen !is well ventilated especially when the appliance is in use": keep natural ventilation holes open or install a mechanical ventilation device (mechanical extractor hood). Prolonged intensive use of the appliance may call for additional ventilation, for example increasing the level of the mechanical ventilation where present."
- Gas appliances and systems must be regularly checked for proper functioning. Please arrange for annual maintenance.

- Clean the gas burners regularly. The flames should be blue and burn evenly.
- Good combustion is required in gas appliances. In case of incomplete combustion, carbon monoxide (CO) might develop. Carbon monoxide is a colourless, odourless and very toxic gas, which has a lethal effect even in very small doses.
- Request information about gas emergency telephone numbers and safety measures in case of gas smell from you local gas provider.

What to do when you smell gas

-  Risk of explosion and poisoning!
Put out all naked flames and do not smoke, strike matches or do anything that could cause ignition.
Do not operate any electric switches (e.g. light switch, TV, computer, cooker or door bell).
Do not use a telephone or mobile phone.
1. Turn off all valves on gas appliances and gas meter at the main control valve, unless it's in a confined space or cellar.
 2. Open doors and windows.
 3. Check all tubes and connections for tightness. If you still smell gas leave the property.
 4. Warn the neighbours.
 5. Call the fire-brigade. Use a telephone outside the house.
 - 5.1 If you have door or gates that are secured by an electric lock, or entry phone, please open these manually.
 6. Do not re-enter the property until you are told it is safe to do so.

Intended use

This product is designed for domestic use. Commercial use is not admissible. "CAUTION: This appliance is for cooking purposes only. It must not be used for other purposes, for example room heating."

This product should not be used for warming the plates under the grill, drying towels, dish cloths and etc. by hanging them on the handles and for heating purposes.

The manufacturer shall not be liable for any damage caused by improper use or handling errors.

The oven can be used for defrosting, baking, roasting and grilling food.

Safety for children

- Accessible parts of the appliance will become hot whilst the appliance is in use and until the appliance has cooled, children should be kept away.
- "**CAUTION:** Accessible parts may be hot when the grill is in use. Young children should be kept away."
- Do not store any items above the appliance that children may reach.
- The packaging materials will be dangerous for children. Keep the packaging materials away from children. Please dispose of all parts of the packaging according to environmental standards.
- When the door is open, do **not** load any heavy object on it and do **not** allow children to sit on it. It may overturn or door hinges may get damaged.

3 Installation

Before installation

To ensure that critical air gaps are maintained under the appliance, we recommend that this appliance is mounted on a solid base and that the feet do not sink into any carpet or soft flooring.

The kitchen floor must be able to carry the weight of the appliance plus the additional weight of cookware and bakeware and food.

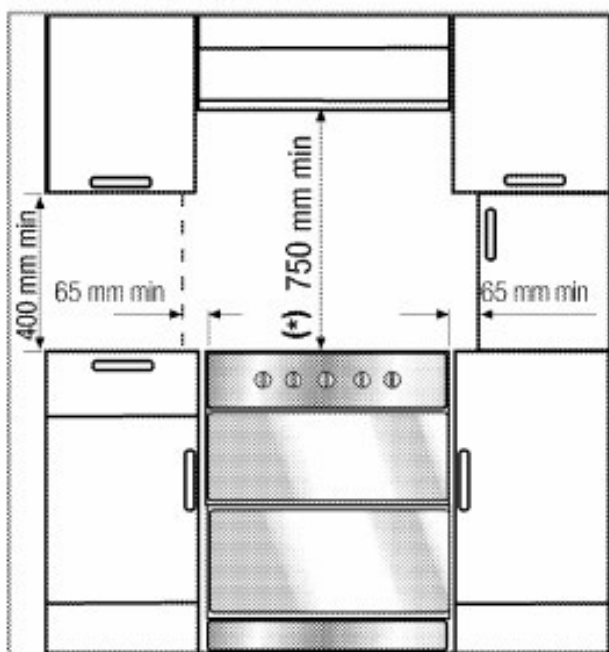

A safety distance must be left between the appliance and the kitchen walls and furniture. See figure (values in mm).

- It can be used with cabinets on either side but in order to have a minimum distance of 400 mm above hotplate level allow a side clearance of 65 mm between the appliance and any wall, partition or tall cupboard.
- It can also be used in a free standing position. Allow a

minimum distance of 750 mm above the hob surface.

- (*) If a cooker hood is to be installed above the cooker, refer to cooker hood manufacturer's instructions regarding installation height (Min 65cm).
- The appliance corresponds to device class 1, i.e. it may be placed with the rear and **one** side to kitchen walls, kitchen furniture or equipment of any size. The kitchen furniture or equipment on the **other** side may only be of the same size or smaller.
- Any kitchen furniture next to the appliance must be heat-resistant (100 °C min.).

i LP Gas Only

Don't install this appliance in a room below ground level unless it is open to ground level on at least one side.

Failure to install appliances correctly is dangerous and could result in prosecution.

Room ventilation

The air for combustion is taken from the room air and the exhaust gases are emitted directly into the room.

Good room ventilation is essential for safe operation of your appliance. If there is no window or door available for room ventilation, an extra ventilation must be installed.

Do not install this appliance in a room below ground level unless it is open to ground level on at least one side.

Failure to install correctly is dangerous and could result in prosecution. Prolonged intensive use of the appliance may call for additional ventilation, for example the opening of a window, or the use of permanent fixed mechanical ventilation system, for example, an extractor fan or cooker hood that ventilates to the outside.

Room size	Ventilation opening
smaller than 5 m ³	min. 100 cm ²
5 m ³ to 10 m ³	min. 50 cm ²
greater than 10 m ³	not required
In the cellar or basement	min. 65 cm ²

Installation and connection

- i** Do not install the appliance next to refrigerators or freezers. The heat emitted by the appliance will lead to an increased energy consumption of cooling appliances.
- Appliance to be installed in accordance with the local authority requirements for gas, electricity and any other authority having jurisdiction.
- Carry the appliance with at least two persons.
- i** **Material damage!**
The door and/or handle must not be used for lifting or moving the appliance.
- The appliance must be placed directly on the floor. It must not be placed onto a base or a pedestal.

Connection to the gas supply

- ⚠** Risk of explosion or poisoning by unprofessional installation.
The appliance may be connected to the gas distribution system only by an authorized qualified person who is Gas Safe registered.
- ⚠** Risk of explosion!
Before starting any work on the gas installation, please shut off the gas supply.
- "The adjustment conditions for this appliance are stated on the label (or data plate)."
- i** Your appliance is adjusted for LP gas.

Connecting the gas hose

- If necessary the gas fittings at the rear of the stove may be changed over, left to right, to suit the location of the gas bottle.

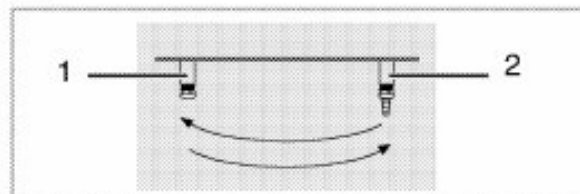

- 1 Plug
 - 2 Hose nozzle
- Have your appliance connected in a way that it will be close to the gas connection and avoid gas leakage.
 - Plastic hose to be used must not be longer than 125 cm.
 - Install the clamp to the hose. Soak one end of the hose (15 mm inner diameter) into boiling water for one minute to soften it.

- Then, slip the softened end of the hose completely onto the sharp hose end of your appliance. Finally, tighten the clamp completely by a screwdriver.
- Repeat the same procedure for the other end of the hose and complete the gas bottle connection.
- Never forget to make the gas leakage control.

⚠ Risk of explosion and suffocation!
LPG bottles must not be stored in the house.

- If you need to use your appliance later with a different type of gas, you must consult the authorised service for the related conversion procedure.

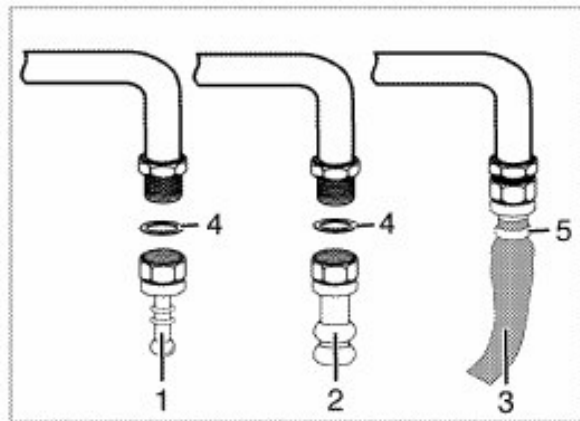
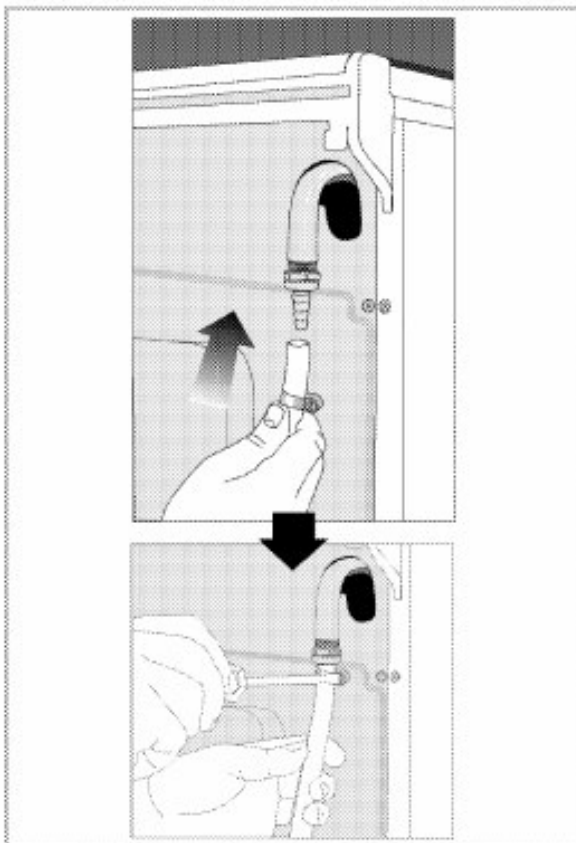

- 1 Hose nozzle-LPG
- 2 Hose nozzle-NG
- 3 Safety hose
- 4 O-ring (seal)
- 5 Clamp

Leakage control at the connection part

- Make sure that all knobs on the appliance are turned off. Make sure that the gas supply is open. Prepare soapy foam and apply it onto the connection edge of the hose for gas leakage control.
- Soapy part will froth if there is a gas leakage. In this case, inspect the gas connection once again.

i Never use a match or lighter to make the gas leakage control.

⚠ Risk of explosion by damage of the safety tube!
The safety tube must not be clamped, bent or trapped or come into contact with hot parts of the appliance.

Connection to the mains supply

i This appliance must be earthed!

Our company shall not be held responsible for any damage caused by using the appliance without earthed socket.

⚠ Risk of electric shock, short circuit or fire by unprofessional installation!

The appliance may be connected to the mains supply only by an authorized qualified person and the appliance is only guaranteed after correct installation.

⚠ Risk of electric shock, short circuit or fire by damage of the mains lead!

The mains lead must not be clamped, bent or trapped or come into contact with hot parts of the appliance.
If the mains lead is damaged, it must be replaced by a qualified electrician.

The mains supply data must correspond to the data specified on the rating plate of the appliance. The rating plate is either seen when the door or the lower cover is opened or it is located at the rear wall of the appliance depending on the appliance type.

The supply cable of the appliance must correspond to the specifications; see technical data table *Technical specifications*, page 5.

i The plug should be easily accessible after installation (but not above the hob).

Plug the mains lead into the socket.

⚠ Risk of electric shock! Before starting any work on the electrical installation, please disconnect the appliance from the mains supply.

- Position appliance up to the kitchen wall.
- To align the appliance with the worktop, adjust the feet turning right or left hand as required.

Final check

1. Check electrical functions.
2. Turn on gas supply.
3. Check gas installations for secure fitting and tightness.
4. Ignite burners and check appearance of the flame.

i The flames should be blue and burn smoothly. If the flames appear yellowish, check secure position of the burner cap or clean the burner. Switch off gas and let burner cool before touching it.

Gas conversion

⚠ Risk of explosion! Before starting any work on the gas installation, please shut off the gas supply.

In order to change your appliance's gas type, change all injectors and make flame adjustment for all valves at reduced flow rate position.

Exchange injector for the burners

1. Take off burner cap and burner body.
2. Unscrew injectors.
3. Fit new injectors.

4. Check all connections for secure fitting and tightness.

i New injectors have their position marked on their packing or injector table on *Injector table, page 7* can be referred to.

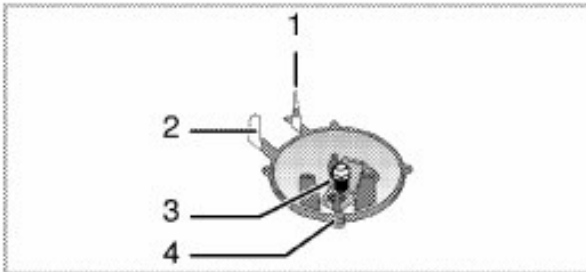

- 1 Flame failure device (model dependant)
- 2 Sparking plug
- 3 Injector
- 4 Burner

i Unless there is an abnormal condition, do not attempt to remove the gas burner taps. You must call an Authorised service agent if it is necessary to change the taps.

Reduced gas flow rate setting for hob taps

1. Ignite the burner that is to be adjusted and turn the knob to the reduced position.
2. Remove the knob from the gas tap.
3. Use an appropriately sized screwdriver to adjust the flow rate adjustment screw.

For LPG (Butane - Propane) turn the screw clockwise.

For the natural gas, you should turn the screw **counter-clockwise** once.

» The normal length of a straight flame in the reduced position should be 6-7 mm.

4. If the flame is higher than the desired position, turn the screw clockwise. If it is smaller turn anticlockwise.

5. For the last control, bring the burner both to high-flame and reduced positions and check whether the flame is on or off.

Depending on the type of gas tap used in your appliance the adjustment screw position may vary.

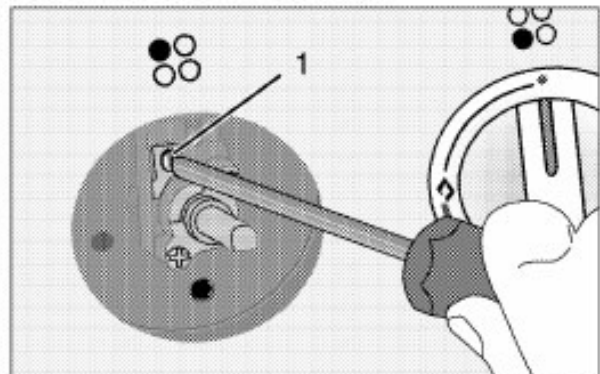

- 1 Flow rate adjustment screw

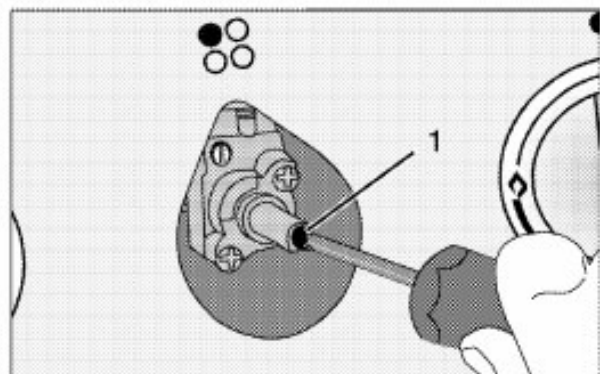

- 1 Flow rate adjustment screw

i If the gas type of the unit is changed, then the rating plate that shows the gas type of the unit must also be changed.

Disposal

Disposing of packaging material

Packaging materials are dangerous to children. Keep packaging materials in a safe place out of reach of children. Packaging materials of the product are manufactured from recyclable materials. Dispose of them properly and sort in accordance with recycled waste instructions. Do not dispose of them with normal domestic waste.

Disposing of the old product





Dispose of the old product in an environmentally friendly manner. This equipment bears the selective sorting symbol for waste electrical and electronic equipment (WEEE). This means that this equipment must be handled pursuant to European Directive 2002/96/EC in order to be recycled or dismantled to minimize its impact on the environment. For further information, please contact local or regional authorities.

Electronic equipments not included in the selective sorting process are potentially dangerous for the environment and human health due to the presence of hazardous substances.

Refer to your local dealer or solid waste collection centre in your area to learn how to dispose of your product. Before disposing of the product, cut off the power cable plug and make the door lock (if any) unusable to avoid dangerous conditions to children.

Future Transportation

- Keep the product's original carton and transport the product in it. Follow the instructions on the carton. If you do not have the original carton, pack the product in bubble wrap or thick cardboard and tape it securely.
- To prevent the wire grill and tray inside the oven from damaging the oven door, place a strip of cardboard onto the inside of the oven door that lines up with the position of the trays. Tape the oven door to the side walls.
- Secure the caps and pan supports with adhesive tape.
- Do not use the door or handle to lift or move the product.
-  Do not place other items on the top of the appliance. The appliance must be transported upright.
-  Check the general appearance of your product for any damages that might have occurred during transportation.

4 Preparation

Tips for saving energy

The following information will help you to use your appliance in an ecological way, and to save energy:

- Use dark coloured or enamel coated cookware in the oven since the heat transmission will be better.
- While cooking your dishes, perform a preheating operation if it is advised in the user manual or cooking instructions.
- Do not open the door of the oven frequently during cooking.
- Try to cook more than one dish in the oven at the same time whenever possible. You can cook by placing two cooking vessels onto the wire grill.
- Cook more than one dish one after another. The oven will already be hot.
- You can save energy by switching off your oven a few minutes before the end of the cooking time. Do not open the oven door.
- Defrost frozen dishes before cooking them.
- Use pots/pans with cover for cooking. If there is no cover, energy consumption may increase 4 times.
- Select the burner which is suitable for the bottom size of the pot to be used. Always select the correct pot size for your dishes. Larger pots require more energy.

Initial operation

Setting the time

- i** Before using the oven the clock time must be set. If the clock time is not set, the main oven will not work.

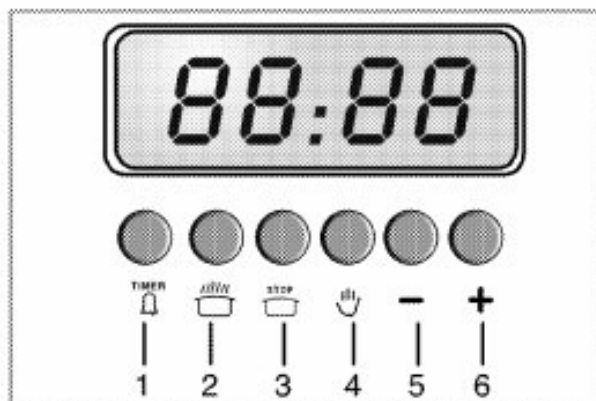

Keys for:

- 1 Alarm clock
- 2 Cooking time
- 3 End of cooking time
- 4 Switch on automatic

Keys for time adjustment:

- 5 Minus key
- 6 Plus key

1. Keep key 1 and key 2 pressed.
2. Set clock with key 5 or key 6. By pressing the key shortly, you advance or reset the clock by one minute. When you keep the individual key pressed, the minutes are advanced or reset quickly.
3. Release key 1 and key 2.

First cleaning of the appliance

i The surface may get damaged by some detergents or cleaning materials.

Do not use aggressive detergents, cleaning powder/cream or any sharp objects.

1. Remove all packaging materials.
2. Wipe the surfaces of the appliance with a damp cloth or sponge and dry with a cloth.

Initial heating

Heat up the product for about 30 minutes and then switch it off. Thus, any production residues or layers will be burnt off and removed.

⚠ Hot surfaces may cause burns! Do not touch the hot surfaces of the appliance. Use oven gloves. Keep children away from the appliance.

Electric oven

1. Take all baking trays and the wire grill out of the oven.
2. Close the oven door.
3. Select Static position.
4. Select the highest grill power; See *How to use the electric oven, page 21*.
5. Operate the oven about 30 minutes.
6. Turn off your oven; See *How to use the electric oven, page 21*

Grill oven

1. Take all baking trays and the wire grill out of the oven.
2. Close the oven door.
3. Select the highest grill power; see *How to operate the grill, page 27*.
4. Operate the oven about 30 minutes.
5. Turn off your grill; see *How to operate the grill, page 27*

i Smell and smoke may emit during first heating. Ensure that the room is well ventilated.

5 How to use the hob

General information about cooking

⚠ Risk of fire by overheated oil!
When you heat oil, do not leave it unattended.

Never try to extinguish the fire with water! When oil has caught fire, immediately cover the pot or pan with a lid. Switch off the hob if safe to do so and phone the fire service.

- Before frying foods, always dry them well and gently place into the hot oil. Ensure complete thawing of frozen foods before frying.
- Do not cover the vessel you use when heating oil.
- Place the pans and saucepans in a manner so that their handles are not over the hob to prevent heating of the handles. Do not place unbalanced and easily tilting vessels on the hob.
- Do not place empty vessels and saucepans on cooking zones that are switched on. They might get damaged.
- Operating a cooking zone without a vessel or saucepan on it will cause damage to the product. Turn off the cooking zones after the cooking is complete.
- As the surface of the product can be hot, do not put plastic and aluminum vessels on it. Such vessels should not be used to keep foods either.
- Use flat bottomed saucepans or vessels only.

- Put appropriate amount of food in saucepans and pans. Thus, you will not have to make any unnecessary cleaning by preventing the dishes from overflowing.
Do not put covers of saucepans or pans on cooking zones.
Place the saucepans in a manner so that they are centered on the cooking zone. When you want to move the saucepan onto another cooking zone, lift and place it onto the cooking zone you want instead of sliding it.

Gas cooking

- Size of the vessel and the flame must match each other. Adjust the gas flames so that they will not extend the bottom of the vessel and center the vessel on saucepan carrier.

Using the hobs

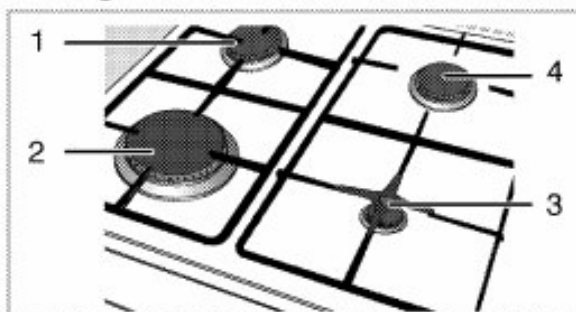

- 1 Normal burner 18-20 cm
- 2 Rapid burner 22-24 cm
- 3 Auxiliary burner 12-18 cm
- 4 Normal burner 18-20 cm is list of advised diameter of pots to be used on related burners.

Large flame symbol indicates the highest cooking power and small flame

symbol indicates the lowest cooking symbol. In turned off position (top), gas is not supplied to the burners.

Igniting the gas burners

1. Keep burner knob pressed.
2. Turn it counter clockwise to large flame symbol.
» Gas is ignited with the spark created.
3. Adjust it to the desired cooking power.

Turning off the gas burners

Turn the keep warm zone knob to off (upper) position.

Gas shut off safety system (in models with thermic component)



As a counter measure against blow out due to fluid overflows at burners, safety mechanism trips and shuts off the gas.

1. Gas shut off safety

- Push the knob inwards and turn it counter clockwise to ignite.
- After the gas ignites, keep the knob pressed for 3-5 seconds more to engage the safety system.
- If the gas does not ignite after you press and release the knob, repeat the same procedure by keeping the knob pressed for 15 seconds.



Risk of deflagration incase of unburned gas!

Do not press the knob for longer than 15 seconds if there was no ignition.

Wait for one minute and then repeat the ignition process.

IMPORTANT

Burn- back (Fire in the burner tube or chamber)

In the event of a burn-back, where the flame burns back to the jet, immediately turn off the gas supply at the control valve or on the control panel. After ensuring the flame is extinguished, wait for one minute and re-light the burner in the normal manner. Should a burn-back re-occur, close the control valve and call a service technician. Do not use the appliance again until a service technician has declared it is safe to do so.

6 How to operate the oven

General information on baking, roasting and grilling

- ⚠** Risk of scalding by hot steam!
Take care when opening the oven door as steam may escape.

Tips for baking

- Use non-stick coated appropriate metal plates or aluminum containers or heat-resistant silicone moulds.
- Make best use of the space on the rack.
- It is recommended to place the baking mould in the middle of the rack.
- Select the correct shelf position before turning the oven or grill on - don't move oven shelves when hot.
- Keep the oven door closed.

Tips for roasting

- Seasoning with lemon juice and black pepper will improve the cooking performance when cooking a whole chicken, turkey or a large piece of meat.
- Meat with bones takes about 15 to 30 minutes longer before it is cooked than a roast of the same size without bones.
- You should calculate about 4 to 5 minutes cooking time per centimeter height of the meat.
- Let meat rest in the oven for about 10 minutes after the cooking time. The juice is better distributed all over the roast and does not run out when the meat is cut.

- Fish in a fire-resistant dish should be placed on the rack at the medium or lower level.

Tips for grilling

Grilling is ideal for cooking meat, fish and poultry and will achieve a nice brown surface without it drying out too much. Flat pieces, meat skewers and sausages are particularly suited for grilling as are vegetables with a high water content such as tomatoes and onions.

- Distribute the pieces to be grilled on the wire shelf.
- If the grilling is on the wire shelf, locate a dripping pan under it in order to collect the fat.
- Add some water in the dripping pan for easy cleaning.

How to use the electric oven

- i** Before using the oven the clock time must be set. If the clock time is not set, the main oven will not work.

Select temperature and operating mode

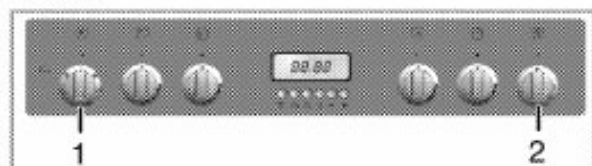

- 1 Function knob
- 2 Thermostat knob

The operating modes of the electric oven are selected with the function knob. The temperature is adjusted with the thermostat knob.

All oven functions are turned off by turning the relevant knob to off (upper) position.

1. Set thermostat knob to the desired temperature.
2. Set function knob to the required operating mode.

» The oven heats up to the adjusted temperature and maintains it. During heating, temperature lamp stays on.

Switch off electric oven

Turn function knob and thermostat knob to off position (top).

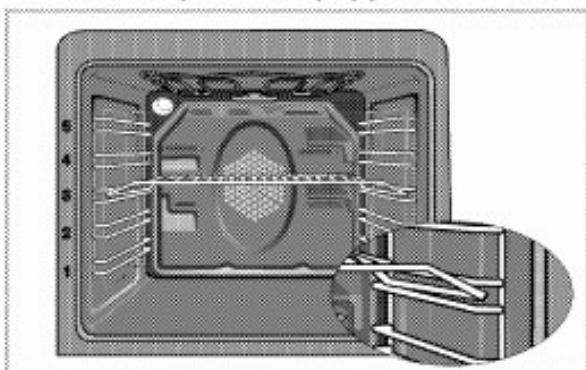

Shelf positions (model dependant)

It is important to position the wire grill on wire shelf correctly. The wire grill must be placed so that it will fit into the opening of the wire shelf as illustrated in the figure.

Operating modes

The order of operating modes shown here might deviate from the arrangement on your appliance.

Top and bottom heat



Top and bottom heat are on. The foodstuffs are heated simultaneously from the upper and lower part. Suitable e.g. for cakes, cookies and casseroles in baking moulds. Cook with one tray only.

Bottom heat



Only bottom heat is on. Is particularly suitable for dishes, such as pizza, which are required to be baked from bottom.

Top and bottom heat with convection air



Top and bottom heat plus fan (in the rear wall) are on. The hot air is distributed evenly and quickly all over the oven by the fan. Cook with one tray only.

Surface grill



The large grill (under the oven roof) is in operation. Suitable for grilling larger quantities.

- Put big or medium-sized portions in correct shelf position under the grill heater for grilling.
- Set the temperature to maximum level.
- Turn the food after half of the grilling time.

Grill with convection air



The grill effect is not as strong as with normal grilling.

- Put small or medium-sized portions in correct shelf position under the grill heater for grilling.
- Set the temperature to maximum level.
- Turn the food after half of the grilling time.

Rapid heating



This mode is used for heating the oven quickly. This mode is **not suitable** for the preparation of food.

- After selecting this mode, choose the desired temperature. The thermostat lamp is lit and the oven is heated.
- When the heating process is completed, the lamp goes off. Now you select the desired operating mode for the preparation of food.

How to operate the oven timer

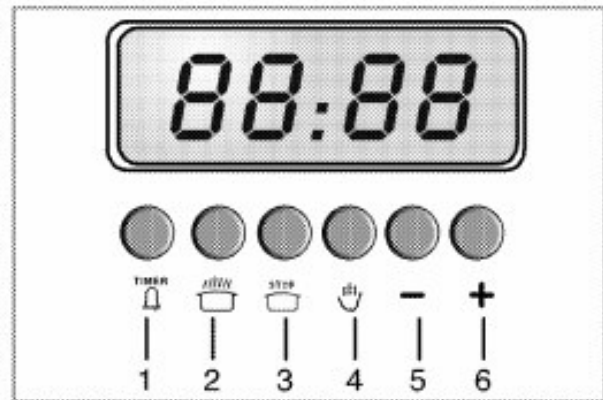

Keys for:

- 1 Alarm clock
- 2 Cooking time
- 3 End of cooking time
- 4 Switch on automatic

Keys for time adjustment:

- 5 Minus key
- 6 Plus key

i The maximum time to be set for the end of the cooking process is 23 hours and 59 minutes. In case of power cut, program will be canceled. Reprogram is needed.

Switch on fully automatic operation

In this mode of operation, you can define when the oven is to switch **on/off** automatically.

1. Keep key **3** pressed.
2. Set end of the cooking time with key **5** or key **6**. By pressing the key shortly, you advance or reset the clock by one minute. When you keep the key pressed, the minutes are advanced or reset quickly.
 - » The indication "**AUTO**" lights up on the display.
3. Release key **3**.
4. Keep key **2** pressed.

5. Set the cooking time with key **5** or key **6**. By pressing the key shortly, you advance or reset the clock by one minute. When you keep the key pressed, the minutes are advanced or reset quickly.
6. Release key **2**.
7. Put your dish into the oven.
8. Select operating mode and temperature.
 - » The oven is heated up to the set temperature and keeps this temperature until the end of the cooking time that has been selected. During the cooking process, the cooking symbol on the display is lit.
9. Press key **3** as soon as the cooking process has been completed and an alarm sounds.
10. Switch the oven off with the thermostat knob and/or the function knob.
11. Press key **4**.
 - » The indication "**AUTO**" on the display goes off.

Switch on semi-automatic operation

In this mode of operation, you can define when the oven is to switch **off** automatically

1. Keep key **2** pressed.
2. Set the cooking time with key **5** or key **6**. By pressing the key shortly, you advance or reset the clock by one minute. When you keep the key pressed, the minutes are advanced or reset quickly.
 - » The indication "**AUTO**" lights up on the display.
3. Release key **2**.
4. Put your dish into the oven.

5. Select operating mode and temperature.
 - » The oven is heated up to the set temperature and keeps this temperature until the end of the cooking time that has been selected. During the cooking process, the cooking symbol on the display is lit.
6. Press key **3** as soon as the cooking process has been completed and an alarm sounds.
7. Switch the oven off with the thermostat knob and/or the function knob.
8. Press key **4**.
 - » The indication "**AUTO**" on the display goes off.

 When you press key **2** during the cooking process, the display will show the remaining cooking time for a short moment.

Interrupting the cooking process

1. Keep key **2** pressed.
2. Keep key **5** pressed until "**0.00**" is shown as remaining cooking time on the display.
3. Release key **2**.
4. Press key **4**.
 - » The indication "**AUTO**" on the display goes off.
5. Switch the oven off with the thermostat knob and/or the function knob.

How to use the alarm clock

In addition to using the timer for cooking, it can be also used as a reminder or an alarm clock.

As soon as the defined period of time has expired, the alarm clock will emit a

signal. The alarm clock has no influence on the functions of the oven.

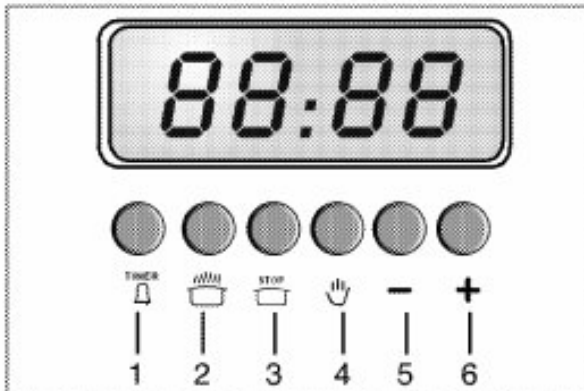

Keys for:

- 1 Alarm clock
 - 2 Cooking time
 - 3 End of cooking time
 - 4 Switch on automatic
- Keys for time adjustment:
- 5 Minus key
 - 6 Plus key

Setting the alarm clock

1. Keep key **1** pressed.
 - i** The maximum alarm time can be 23 hours and 59 minutes.
2. With key **5** or key **6** you can set the period of time which is to elapse before the alarm signal sounds. By pressing the key once, you advance or reset the clock by one minute. When you keep the individual key pressed, the minutes are advanced or reset quickly.
 - » The alarm clock symbol on the display lights up.

Dish	Cooking level number		Rack position	Temperature (°C)	Cooking time (approx. in min.)
**Cakes in tray	One level		4	175	30 ... 35
**Cakes in mould	One level		2	175	40 ... 50
**Cakes in cooking paper	One level		3	175	25 ... 30
**Sponge cake	One level		3	200	5 ... 10
**Cookie	One level		3	175	20 ... 25

3. Release key **1**.

i When you press key **1** while the alarm clock is activated, the display will show the remaining cooking time for a short moment.

Switching off the alarm

1. Keep key **3** pressed as soon as the alarm signal sounds.
 - » The alarm clock symbol on the display is extinguished.

In order to cancel set alarm time;











1. To reset the alarm time, keep key **1** pressed.
2. Keep key **5** pressed until "0.00" is shown as remaining time on the display.
3. Release key **1**.
 - » The alarm clock symbol on the display is extinguished.

Cooking times table

i The values indicated in the table below are data indicative. They may vary according to the type of food as well as your preferences of cooking.

Baking and roasting

i Level 1 is the **bottom** level in the oven.

Dish	Cooking level number		Rack position	Temperature (°C)	Cooking time (approx. in min.)
**Dough pastry	One level		2	200	30 ... 40
**Rich pastry	One level		2	200	25 ... 35
**Leaven	One level		2	200	35 ... 45
**Lasagna	One level		2 - 3	200	30 ... 40
**Pizza	One level		2	200 ... 220	15 ... 20
Beef steak (whole) / Roast	One level		3	25 min. 250/max, then 180 ... 190	100 ... 120
Leg of Lamb (casserole)	One level		3	25 min. 220 then 180 ... 190	70 ... 90
Roasted chicken	One level		2	15 min. 250/max, then 190	65 ... 70
Turkey (5.5 kg)	One level		2	25 min. 250/max, then 190	150 ... 210
Fish	One level		3	200	20 ... 30

In a cooking that requires preheating, preheat at the beginning of cooking until the thermostat lamp turns off.

Tips for baking cake

- If the cake is too dry, increase the temperature some 10 and decrease the cooking time.
- If the cake is wet, use less liquid or lower the temperature by 10°C.
- If the cake is too dark on top, place it on a lower rack, lower the temperature and increase the cooking time.
- If cooked well on the inside but sticky on the outside use less liquid, lower the temperature and increase the cooking time.

Tips for baking pastry

- If the pastry is too dry, increase the temperature some 10 and decrease the cooking time. Dampen the layers of dough with a sauce composed of milk, oil, egg and yoghurt.
- If the pastry takes too long to bake, pay care that the thickness of the pastry you have prepared does not exceed the depth of the tray.

- If the upper side of the pastry gets browned, but the lower part is not cooked, make sure that the amount of sauce you have used for the pastry is not too much at the bottom of the pastry. Try to scatter the sauce equally between the dough layers and on the top of pastry for an even browning.

i Cook the pastry in accordance with the mode and temperature given in the cooking table. If the bottom part is still not browned enough, place it on one lower rack next time.

Tips for cooking vegetables

- If the vegetable dish runs out of juice and gets too dry, cook it in a pan with a lid instead of a tray. Closed vessels will preserve the juice of the dish.
- If a vegetable dish does not get cooked, boil the vegetables beforehand or prepare them like canned food and put in the oven.

Other functions

How to operate the grill

i Before using the oven the clock time must be set. If the clock time is not set, the main oven will not work.

⚠ Hot surfaces may cause burns!
Close oven door during grilling.

Switch on grill

1. Set the function knob onto the grill symbol.
2. Set grill temperature.

Cooking times table for grilling

Grilling with electric grill

Food	Insertion level	Grilling time (approx.)
Fish	4...5	20...25 min. [#]
Sliced chicken	4...5	25...35 min.
Lamb chops	4...5	20...25 min.
Roast beef	4...5	25...30 min. [#]
Veal chops	4...5	25...30 min. [#]
Toast bread	4	1...2 min.

[#] depending on thickness

3. Preheat for approximately 5 minutes, if it is necessary.
» The thermostat lamp is switched on.

Switch off grill

1. Turn grill control knob to off position (top).

Shelf positions

For optimum grill coverage, position the wire shelf towards the front of the oven just out of contact with the glass door. Placing the wire shelf fully to the rear of the oven will reduce the grill coverage.

7 Maintenance and care

General information

Service life of the product will extend and frequent problems will decrease if the product is cleaned at regular intervals.

- ⚠ Risk of electric shock!
Switch off the electricity before cleaning appliance to avoid an electric shock.
 - ⚠ Hot surfaces may cause burns!
Allow the appliance to cool down before you clean it.
 - Clean the product thoroughly after each use. In this way it will be possible to remove cooking residues more easily, thus avoiding these from burning the next time the appliance is used.
 - No special cleaning agents are required for cleaning the product. Use warm water with washing liquid, a soft cloth or sponge to clean the product and wipe it with a dry cloth.
 - Bu cümle türkçeye çevrilecek!!! - Always ensure any excess liquid is thoroughly wiped off after cleaning and any spillage is immediately wiped dry.
 - Do not use cleaning agents that contain acid or chloride to clean the stainless or inox surfaces and the handle. Use a soft cloth with a liquid detergent (not abrasive) to wipe those parts clean, paying attention to sweep in one direction.
- (optional)** - Do not use solid metal scrapers or abrasive cleaning materials

to clean the glass cover. Glass surface can get damaged.

- ❗ The surface may get damaged by some detergents or cleaning materials.

Do not use aggressive detergents, cleaning powder/cream or any sharp objects.

- ❗ Do not use steam cleaners for cleaning.

Cleaning the hob

Gas hobs

1. Remove and clean the saucepan carriers and burner caps.
2. Clean the hob.
3. Install the burner caps and make sure that they are seated correctly.
4. When installing the upper grills, pay attention to place the saucepan carriers so that the burners are centered.

Cleaning the control panel

Clean the control panel and control knobs with a wet cloth and wipe them dry.

- ❗ Damage of the control panel!
Do not remove the control knobs for control panel cleaning.

Cleaning the oven

No oven cleaner or any other special cleaning agent is required for cleaning the oven. It is recommended to wipe the oven with a damp cloth while it is still warm.

Clean oven door

Don't use any harsh abrasive cleaners or sharp metal scrapers for cleaning the oven door. They could scratch the surface and destroy the glass.

Removal of oven door

1. Open the front door.
2. Open the clips at the hinge housing on the right and left hand sides of the front door by pressing them down as illustrated in the figure.

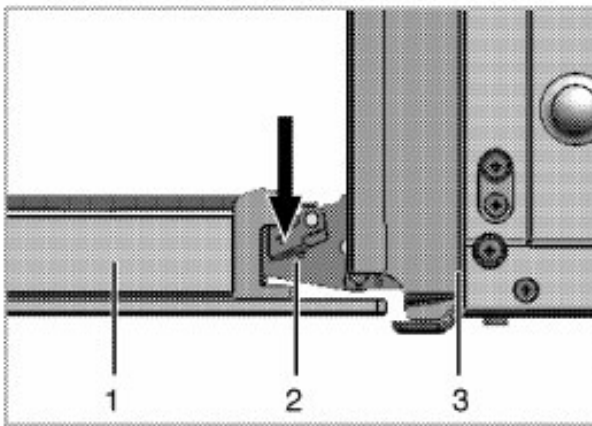

- 1 Front door
- 2 Hinge
- 3 Oven

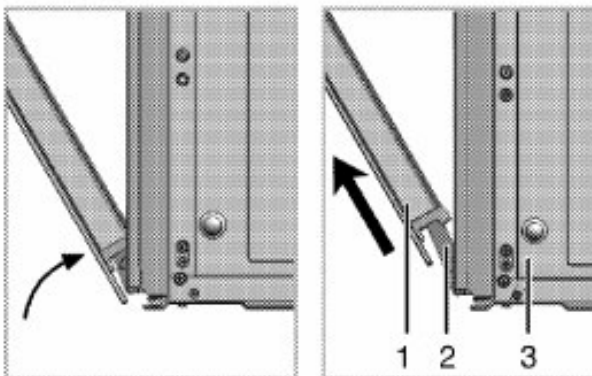

3. Move the front door to half-way.
4. Remove the front door by pulling it upwards to release it from the right and left hinges.

- i** Steps carried out during removing process should be performed in reverse order (steps 4, 3, 2 and 1) to reattach the door. Do not forget to close the clips at the hinge housing when reinstalling the door.

Replacing the oven lamp

- ⚠** Hot surfaces may cause burns! Make sure that the appliance is switched off and cooled down in order to avoid the risk of an electrical shock.

- i** The oven lamp is a special electric light bulb that can resist up to 300 °C. See *Technical specifications, page 5* for details. Oven lamps can be obtained from Authorised Service Agents.

- i** Position of lamp might vary from the figure.

If your oven is equipped with a round lamp:

1. Disconnect the product from mains.
2. Turn the glass cover counter clockwise to remove it.

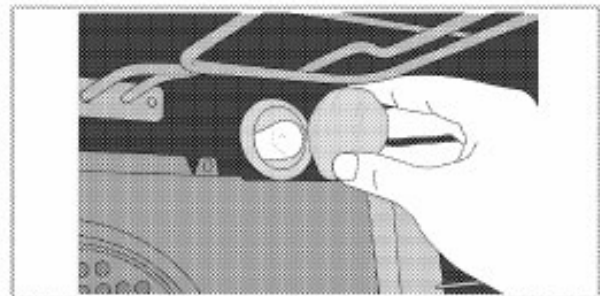

3. Remove the oven lamp by turning it counter clockwise and replace it with the new one.
4. Install the glass cover.

8 Troubleshooting

 Risk of electric shock, short circuit or fire by unprofessional repairs!
Repairs on the appliance must be carried out by an approved service centre.

 Risk of explosion or poisoning by unprofessional repair.
Repairs on the appliance must be carried out by an approved service centre.

Normal operating conditions

- Smoke and smell may emit for a couple of hours during the first operation.
- It is normal that steam escapes during operation.
- When the metal parts are heated, they may expand and cause noise.

Before you call the service, please check the following points.

Electrical equipment

Malfunction/problem	Possible cause	Advice/remedy
The appliance does not work.	The mains fuse is defective or has tripped.	Check fuses in the fuse box. If necessary, replace or reset them.
	Appliance's plug can not be connected to the grounded socket.	Check the plug connection.
Oven light does not work	Oven lamp is defective.	Replace oven lamp.
	No current.	Check fuses in the fuse box. If necessary, replace or reset them.
Oven does not heat.	Function knob and/thermostat knob are not set.	Set function knob and thermostat knob.
	If the appliance has a timer, the timer may not be set.	Set the time.
	No power.	Check mains supply and fuse box.

Gas

Malfunction/problem	Possible cause	Advice/remedy
No ignition spark is produced.	No electric supply to the appliance.	Check fuses in the fuse box.
No gas is emitted.	Main gas tap is closed.	Open gas tap.
	Safety tube is bent.	Install safety tube without bends.
Burners do not burn smoothly or not at all.	Burners are dirty.	Clean burner parts.
	Burners are not dry.	Dry burner parts.
	Burner cap is not securely positioned.	Position burner correctly.
	Gas tap is closed.	Open gas tap.
	Gas container is empty (in case of LPG connection).	Replace gas container.

Clock/ timer (If the appliance has a digital timer)

Malfunction/problem	Possible cause	Advice/remedy
Clock display is blinking or clock symbol is on.	Power was interrupted previously.	Set time Then switch the oven off with function knobs, set the oven function again.

If the problem has not been solved:

1. Separate unit from the mains supply (deactivate or unscrew fuse).
2. Call the after-sales service of your store reseller.

i Do not attempt to repair the appliance yourself. There are no customer service items inside the appliance.

9 Safety compliance with local requirements.



Flexible hose - Not supplied.

Any hose that is used to connect the stove to the gas system shall comply with SANS 1156-2 or BS 3212.

Temporary installation.

Flexible hose connection from the gas appliance to the cylinder can be made by the user. Ensure that pipe clamps are tightened correctly and are of good quality.

Gas cylinder - Not supplied.

For best results we recommend that gas cylinders with a minimum capacity of 19kg be used.

Regulator - Not supplied.

A 2,8 kPa LPG regulator which complies with SANS 1237 must be used.

Permanent installation.

The appliance may only be installed by a Qualified Gas Fitter who is registered with the **LPGSASA**. (Liquid Petroleum Gas Association of Southern Africa) All registered Gas Fitters are issued with an identity card which carries their registration number. Make a note of this on the space provided below.

The Gas Fitter should also provide you with a written certificate after completion of the work. **Failure to comply with the above will render the warranty invalid.**

Before the installer hands over the installed appliance ensure that you understand:

- a) The position of the isolation or shut-off valve in the gas supply line to the appliance.
- b) The requirements for safe operation of the appliance.

Note. This appliance is supplied ex-factory with jets and air settings for use with **LPG (liquid petroleum gas) only.**

Installer's details to be filled in on page 36

10 Gas Jet Cleaning Procedure

- Every six months the gas jets on your hob should be cleaned to ensure continued efficient and safe operation.
- This may be done using a Gas Jet Cleaning Kit which may be purchased from your nearest Defy Service Centre.
- The kit comprises of a sliding T-bar (A) a socket (B) and a 'Classic pin' (C).

- **Fit the T-bar to the socket and remove the pot stands, burner caps and burner bodies.**

1. Insert the socket into the central tube of the burner so that it locates over the brass gas jet at the bottom of the tube.

2. Gently loosen the brass gas jet by turning the socket in a anti-clockwise direction.

3. Carefully lift the socket and loosened brass gas jet from the central burner tube.

4. Insert the Classic pin into central hole of the jet and slide it up and down until the jet is free of accumulated dirt.

5. Re-assemble in reverse order.
6. Clean all the burner jets in the manner described above.

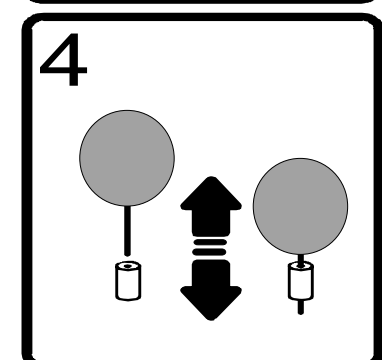
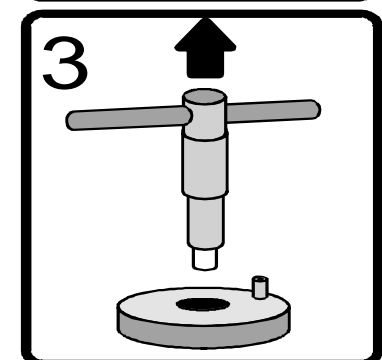
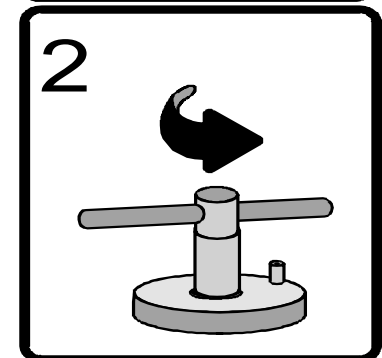
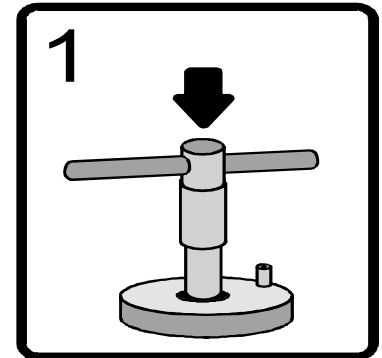
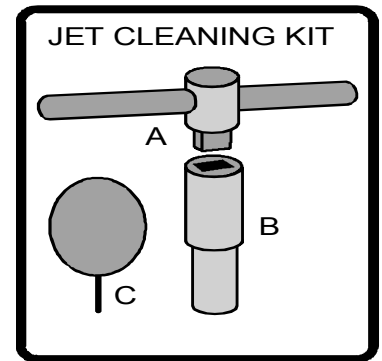

11 Defy Service Centres

If you have followed the instructions and still have a problem, contact the nearest Defy Technical Support Centre. They will be able to advise you on any aspect of the product or send a qualified technician to repair it.

BLOEMFONTEIN 160 Long Street, Hilton,
Bloemfontein 9301.
Tel. 051 400 3900
Bloemfontein.Service@defy.co.za

CAPE TOWN 5A Marconi Rd.
Montague Gardens, 7441.
Tel. 021 526 3000
CapeTown.Service@defy.co.za

DURBAN 35 Intersite Avenue,
Umgeni Business Park, Durban 4051.
Tel. 031 268 3300
Durban.Service@defy.co.za

EAST LONDON 16 Bowls Rd. Arcadia,
East London 5201.
Tel. 043 743 7100
EastLondon.Service@defy.co.za

JOHANNESBURG Cnr. Mimetes & Kruger Sts. Denver ext.12
Commercial Head Office,
Administration, Distribution, National Groups,
Tel. Sales, Contracts and Credit.
Johannesburg. 2094.
Tel. 011 621 0200 or 011 621 0300
Gauteng.Service@defy.co.za

POLOKWANE 87 Nelson Mandela Drive.
Superbia 0699.
Tel. 0152 92 1166 / 7 / 8 / 9.
Polokwane.Service@defy.co.za

PORT ELIZABETH 112 Patterson Road,
North End, Port Elizabeth 6001.
Tel. 041 401 6400
PortElizabeth.Service@defy.co.za

PRETORIA. Block A1 Old Mutual Industrial Park.
Cnr. D.F.Malan Drive & Moot Str.
Hermanstad. 0082.
Tel. 012 377 8300
Pretoria.Service@defy.co.za

**OTHER AREAS ARE SERVICED BY OVER 200 AUTHORISED AGENTS.
FOR FURTHER DETAILS PLEASE CONSULT THE NEAREST REGIONAL
DEFY TECHNICAL SUPPORT CENTRE**

12 Warranty

This certificate is issued by DEFY APPLIANCES (PTY) LTD manufacturers of Defy and Ocean products, hereinafter the Company, to the original purchaser only, of the appliance described on the certificate and shall constitute the only warranty given in respect of this appliance.

The Company warrants to the original purchaser that for a period of TWO YEARS from date of purchase the appliance is free from defect under normal domestic use, both in workmanship and material, subject to the following conditions.

1. Repair or replacement of any part of this appliance, found by the Company to be defective, shall be at the election of the Company. The Company reserves the right to effect such service through any of its Service Divisions or Authorised Service Dealers. The cost of such service shall be borne by the Company in full, provided that the appliance is located no further than 50 km from a Company Service Centre or an Authorised Service Dealer. Where the appliance is located beyond the 50 km radius, the purchaser shall be liable for the standard travelling charges, as determined by the Company.

CARRY IN SERVICE Microwave ovens, Compact cookers and small appliances are repaired in our service centres and are not collected from the customers home. Faulty units should be delivered to the purchasing dealer or to the nearest Company Service Centre for warranty repairs.

2. Rusted or corroded plates, vitreous enamelware, fuses and lamps are specifically excluded from these warranties. It is an express condition of these warranties that the purchaser takes due care and attention in the use and maintenance of the appliance. Abuse, misuse in conflict with operating instructions, connection to incorrect voltages and subjection to commercial use shall release the Company from its obligations.

3. This warranty shall become void and cease to operate if the appliance is dismantled by, or any repairs to the appliance are effected by any persons not duly authorised by the Company, or if substitute parts not approved by the Company are used in the appliance, or if the serial number of the appliance is removed.

4. The Company shall not be responsible for damages resulting from fire, flood, civil disturbances or any Act of God. The Company shall not, in terms of these warranties be responsible nor held liable for any consequential loss or damage of any kind caused by or due to the failure or malfunction of the appliance.

5. The Company shall not be responsible for transportation or other costs other than those incurred within the provisions of Point 1 of this Certificate.

6. These warranties shall not apply to the appliance if it is purchased or used beyond the borders of the Republic of South Africa, Namibia, Botswana, Swaziland and Lesotho.

7. Where service is requested under warranty and no fault or defect can be found by the Company, all costs incurred will be for the purchaser's account.

8. This Certificate as well as your invoice will serve as proof of purchase. For the purpose of warranty, it will be essential to produce this Certificate and invoice. Failure to do so, will render the purchaser liable for service costs.

KEEP THIS CERTIFICATE AND SALES INVOICE AS PROOF OF PURCHASE FOR WARRANTY PURPOSES.

13 Installer's details to be recorded below

INSTALLER'S NAME AND COMPANY:

.....
.....

INSTALLER'S REGISTRATION NUMBER:

.....
.....

HAVE YOU RECEIVED A WRITTEN COMPLETION CERTIFICATE?

.....
.....

HAS THE INSTALLER EXPLAINED THE OPERATIONAL DETAILS OF YOUR STOVE TO YOU?

.....
.....

For future reference, record the listed information in the space below.

The Serial number may be found at the base of the hob

SERIAL NUMBER:.....

DATE OF PURCHASE:.....

PURCHASED FROM:.....

.....
.....

**Please register your product at
www.defy.co.za**



Free Manuals Download Website

<http://myh66.com>

<http://usermanuals.us>

<http://www.somanuals.com>

<http://www.4manuals.cc>

<http://www.manual-lib.com>

<http://www.404manual.com>

<http://www.luxmanual.com>

<http://aubethermostatmanual.com>

Golf course search by state

<http://golfingnear.com>

Email search by domain

<http://emailbydomain.com>

Auto manuals search

<http://auto.somanuals.com>

TV manuals search

<http://tv.somanuals.com>