

Specification Line[®]

Self-Contained Solid Door Narrow Reach-In Freezer

Project _____

Item _____

Quantity _____

CSI Section 11400

Approved _____

Date _____

Models

One section	Two section	
SSF1N-S	SSF2N-S	Stainless exterior and interior full door
SSF1N-SH	SSF2N-SH	Stainless exterior and interior half door
SAF1N-S	SAF2N-S	Stainless exterior and aluminum interior full door
SAF1N-SH	SAF2N-SH	Stainless exterior and aluminum interior half door
SMF1N-S	SMF2N-S	Stainless front aluminum exterior and interior full door
SMF1N-SH	SMF2N-SH	Stainless front aluminum exterior and interior half door



SSF1N-S

Standard Features

- Stainless steel interior and exterior (SS)
- Stainless steel exterior, aluminum interior (SA)
- Aluminum interior and exterior, stainless front (SM)
- Built in door locks with heavy duty strikes
- Recessed metal door handle
- Pressure relief valve is standard to prevent door vapor lock
- Exterior digital thermometer with high/low temperature alarm
- Easy to use electronic control
- Easy access "flip up" shroud
- Three wire shelves per section - SA/SS standard with chrome plated shelves and SM standard with epoxy coated shelves
- Tough ABS interior door liners
- 10' attached cord and plug
- 6" adjustable stainless steel legs
- Stainless steel breaker strips
- High density foamed in place environmentally friendly, Kyoto Protocol Compliant, Non ODP (Ozone Depletion Potential), Non GWP (Global Warming Potential) polyurethane keeps energy costs low
- Energy savings door heater switch
- Two year parts & labor warranty
- Five year compressor warranty

Options & Accessories

- Security (prison) package
- 6" polyurethane casters
- Door field rehingability
- Stainless steel interior door liner
- Additional shelves
- Tray slides
- Stainless steel back
- Laminate on front, sides and back
- Bottom mount electrical
- Stainless steel banking strip
- Heat shield end
- Stainless steel kick plate
- Laminate kick plate
- 4" stainless steel utility base
- 230-50-1 electrical
- 220-60-1 electrical

Specifications

Exterior: SS and SA models shall have corrosion resistant stainless steel exterior cabinet sides, front and shroud. SM models shall have corrosion resistant aluminum on exterior cabinet sides and will have stainless front and shroud. All units shall have the upper shroud hinged with a gas assist stay open feature to provide easy access to the refrigeration system.

Interior: Cabinet interior shall be corrosion resistant stainless steel (SS models) or heavy gauge aluminum (SA and SM models). Bottom and top surfaces shall be die stamped to provide radius corners and recessed floor. Three wire shelves are provided per section, SA/SS standard shelves are chrome plated, SM standard shelves are epoxy coated. Shelves rest on clips which are adjustable on 1" increments on stainless steel pilasters affixed to the cabinet interior. Pilasters are removable without tools for cleaning. Mounted to the interior ceiling, the interior incandescent light is controlled automatically through a switch mounted in the hinge assembly to protect against breakage. Door openings are protected with heavy gauge stainless steel breaker strips. An air duct shall be mounted to the ceiling assuring low velocity, even air movement throughout the cabinet interior.

Doors: Exterior shall be corrosion resistant stainless steel. Interior liner shall be resilient high impact ABS material formed to protrude beyond the door gasket to protect the gasket from tearing. Each door has two edge mount, self closing, cam lift style hinges. Doors can be removed from the cabinet without the use of tools. Metal

door handle shall be recessed into the door for easy grip without impacting aisle space. Keyed door lock is mounted in the door next to the handle. Lock engages into a heavy duty strike mounted to the cabinet face. Door gaskets are magnetic and mount to the door snapping in place and are removable without tools.

Refrigeration system: All components are mounted to the exterior of the cabinet ceiling, outside the food zone and are assembled as one piece and can be removed as one piece. Environmentally friendly R404A refrigerant is used. The system has the capability of maintaining between -5°F and 0°F in heavy use food service operations. Refrigerant is metered using a highly responsive thermostatic expansion valve. System is controlled using Delfield's ACT-Advanced Control Technology electronic temperature control, which provides improved pull down times, reduces compressor cycling and longer compressor life with lower energy consumption.

Control system uses adaptive defrost to assure evaporator coil is free of ice and is operating at optimum efficiency. Evaporator condensate is eliminated using an energy efficient hot gas system.

Electrical: Standard electrical connections shall be 115V, 60 Hz single phase. A 10' cord and plug is supplied and attached to a junction box mounted on the exterior top of the cabinet.

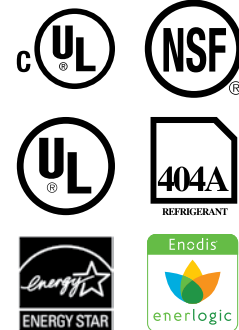

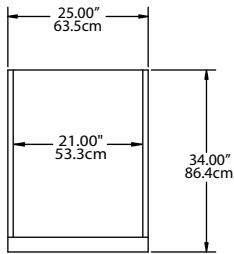

PLAN VIEW
SSF1N-S, SAF1N-S, SMF1N-S
SSF1N-SH, SAF1N-SH, SMF1N-SH

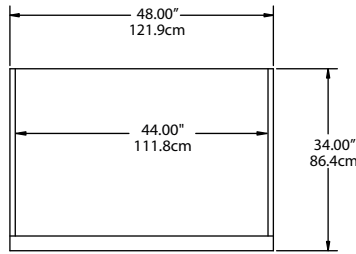

PLAN VIEW
SSF2N-S, SAF2N-S, SMF2N-S
SSF2N-SH, SAF2N-SH, SMF2N-SH

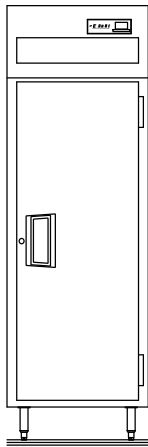

ELEVATION VIEW
SSF1N-S, SAF1N-S,
SMF1N-S

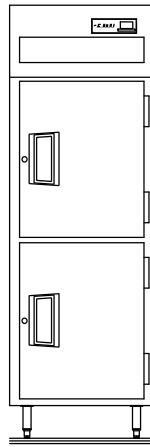

ELEVATION VIEW
SSF1N-SH, SAF1N-SH,
SMF1N-SH

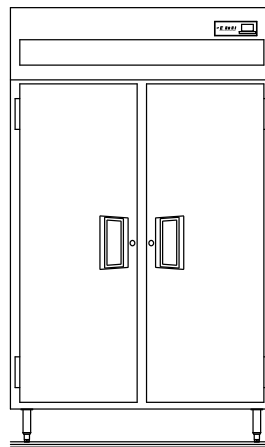

ELEVATION VIEW
SSF2N-S, SAF2N-S,
SMF2N-S

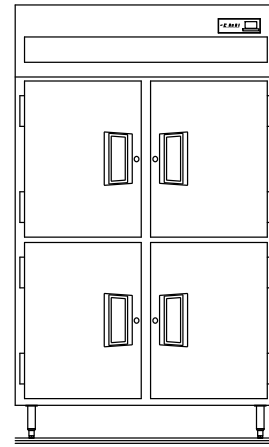

ELEVATION VIEW
SSF2N-SH, SAF2N-SH,
SMF2N-SH

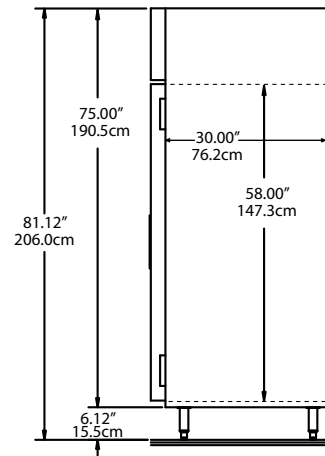

END VIEW
ALL MODELS

Mechanical Data

MODEL NUMBER	VOLTAGE	AMPS	STORAGE CU.FT.	SHELVES SQ.FT.	NO. OF SHELVES	UNIT H.P.	BTU/HR SYSTEM CAP	SHIP WEIGHT	NEMA PLUG	ENERGY (KWH)
SSF1N-S, SSF1N-SH, SAF1N-S, SAF1N-SH, SMF1N-S, SMF1N-SH	115	7.8	20.97	10.59	3	1/2	1516	408lbs (185kg)	5-15P	7.58
SSF2N-S, SSF2N-SH, SAF2N-S, SAF2N-SH, SMF2N-S, SMF2N-SH	115	12.0	43.94	23.10	6	3/4	2648	680lbs (308kg)	5-15P	11.13

Delfield reserves the right to make changes to the design or specifications without prior notice.

980 S. Isabella Rd.
Mt. Pleasant, Michigan 48858

Phone: 800-733-8948 or 989-773-7981
Fax: 800-669-0619
www.delfield.com

Printed in the U.S.A.
DSSSFN
06/08

Enodis®

Free Manuals Download Website

<http://myh66.com>

<http://usermanuals.us>

<http://www.somanuals.com>

<http://www.4manuals.cc>

<http://www.manual-lib.com>

<http://www.404manual.com>

<http://www.luxmanual.com>

<http://aubethermostatmanual.com>

Golf course search by state

<http://golfingnear.com>

Email search by domain

<http://emailbydomain.com>

Auto manuals search

<http://auto.somanuals.com>

TV manuals search

<http://tv.somanuals.com>