



T5, T14D, T20C, T24C, T40 Blast Chiller/Shock Freezers

Service, Installation and Care Manual

Please read this manual completely before attempting to install or operate this equipment! Notify carrier of damage! Inspect all components immediately. See page 2.



Blast Chillers/Shock Freezers



**IMPORTANT INFORMATION
READ BEFORE USE
PLEASE SAVE THESE INSTRUCTIONS!**

Effective Date August 2006
Enodis®

CONTENTS

1. GENERAL DOCUMENTATION

1.1	General information	page	5
1.2	Installation	page	5
1.3	Transport and handling	page	5
1.4	Unpacking - disposal of packaging materials	page	5
1.5	General safety regulations	page	6

2. INSTALLATION

2.1	Data plate information	page	6
2.2	Positioning	page	6
2.3	Ambient temperature and air circulation	page	7
2.4	Electrical connections	page	7
2.5	Refrigeration component connections - remote assemblies	page	7
2.6	Condensate drainage connection	page	7
2.7	Information for the installation technician	page	8
2.8	Safety and control systems	page	8
2.9	Appliance disposal	page	8

3. ADVICE TO ENSURE EFFICIENT APPLIANCE OPERATION

3.1	Shut-down procedures	page	9
3.2	Operating tips	page	9
3.2.1	Precooling	page	9
3.2.2	Loading the appliance	page	9

4. DESCRIPTION OF THE CONTROL PANEL

4.1	Push-buttons	page	11
-----	--------------	------	----

5. PROGRAMMING AND OPERATING INSTRUCTIONS

5.1	Starting up the appliance	page	12
5.2	Soft blast chilling by temperature	page	13
5.3	Soft timed blast chilling	page	14
	Hard blast chilling	page	14
5.4	Hard blast chilling by temperature	page	15
5.5	Hard timed blast chilling	page	16
5.6	Blast freezing by temperature	page	17
5.7	Timed blast freezing	page	18

6. APPLIANCE FUNCTIONS

6.1	Date and time settings	page	19
6.2	Ice cream surface hardening	page	19
6.3	Muting the beeper and alarm reset	page	19
6.4	Program storage	page	19
6.5	Displaying the three latest HACCP alarms	page	20
6.6	Printing out stored data	page	20
6.7	Forced ventilation function	page	20
6.8	User programming	page	20
6.9	Manual defrosting	page	20
6.10	Automatic defrost cycles	page	20

7. ALARM MANAGEMENT

7.1	Storage of data/errors	page	22
7.2	Alarms list	page	22

8. MAINTENANCE AND CLEANING

8.1	General safety regulations	page	27
8.2	Cleaning the condenser	page	27
8.3	Cleaning the cell	page	28
8.4	Defrost water drainage	page	28

1. GENERAL DOCUMENTATION

1.1. General information

- This manual is an integral part of the product, providing all the information required to ensure correct installation, operation and maintenance of the machine.
- Read the manual carefully, making reference to it for machine operation. Keep the manual in a safe place where it can be accessed by all authorised operators (installers, operators and service personnel).
- The machine has been designed for professional applications only and should only be operated by qualified personnel.
- The machine must only be used for the purposes for which it was designed, i.e. for chilling and freezing food products.

The machine must not be used for products requiring constant temperature control and recording, such as:

- heat-sensitive chemicals,
- medicines or
- blood products.
- The manufacturer declines all responsibility for any damage caused by incorrect or unreasonable machine use, such as:
 - improper use by untrained persons;
 - technical modifications or operations not suited to specific models;
 - use of non-original or non-specific spare parts;
 - failure to follow the instructions given in this manual.

1.2 Installation

In the event that the machine is fitted with a remote condenser unit, the installation technician is responsible for checking all connections in compliance with the instructions given by Delfield for plant and machine installation.

1.3 Transport and handling

- To load or unload the machine and/or components from/onto the means of transport, use a lift truck or fork lift equipped with forks that are at least half the length of the machine housing; use a crane if the machine is fitted with eye bolts. Select the lifting equipment suited to the weight and overall dimensions of the packaged machine/components.
- When handling the machine/ components,

apply all precautions to prevent damage, in compliance with the information given on the packaging material

1.4 Unpacking

- Remove all cardboard, wood or other materials from the wood base on which the machine is set. Lift the machine/components with suitable means (e.g. lift truck), remove the wood base, then position the machine/components in the allocated site.
- Once all packing material has been removed, check that the machine has not been damaged in any way.

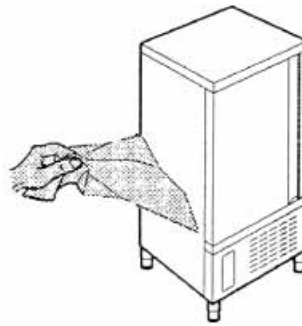

- Remove the protective PVC film on the stainless steel panels from all internal and external surfaces (fig. 2).
- Always wear protective gloves when handling packing material and the wood base.

- NB Dispose of packing materials in compliance with disposal regulations applied in the country where the machine is to be installed. Never dispose of materials in the environment.

1.5 General safety regulations

Failure to observe the recommendations made by the present manual will be at the entire responsibility of the machine user. The main safety regulations are as follows:

- **do not touch the machine with moist or wet hands or feet;**
- **never operate the machine while barefoot;**
- **do not insert screwdrivers, cooking utensils or any other object between the guards and moving parts;**
- **before performing cleaning or routine maintenance operations, disconnect the machine from the power supply at the master switch and the main knife switch (if present);**
- **never pull on the power cable to disconnect the machine from the power supply.**

2. INSTALLATION

2.1 Data plate information

- Check that the data specified on the plate correspond to the characteristics of the power supply (V, kW, Hz, no. phases and power available).
- The dataplate with appliance specifications is located at the rear exterior of the machine

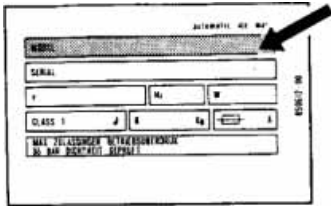

and/or on the electrical boards (fig. 3). The set-up of individual units and the installation of condensers are subject to the fire-safety regulations

of the country in which the machine is installed; seek all necessary advice from the local fire-fighting authorities. Bear in mind that the intervention of safety valves or plug fuses in the refrigerating circuit will lead to the immediate discharge of refrigerant into the environment.

2.2 Positioning

- The machine must be installed in complete compliance with safety regulations, procedures and standing laws.
- Position the machine in the allocated site.
- Adjust the machine feet by turning the foot clockwise until the appliance is perfectly level. In the case of particularly heavy equipment, use appropriate lifting means.

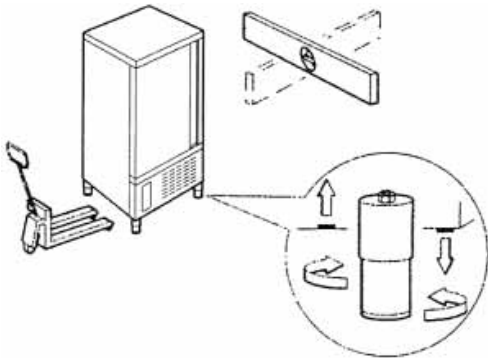

(fig. 4).

- If the appliance is not perfectly level, correct operation and condensate flow-off will not be assured.

AVOID

- direct exposure to sunlight;
- closed sites with high temperatures and poor air circulation;
- installing the machine near sources of heat

Installation Clearance Requirements

All Cabinets:

- 12" clearance above top
- 12" clearance on sides and rear

Remote condensing units for T20, T24 and T40 models.

- 24" clearance above top
- 6" clearance on sides and rear

2.3 Ambient temperature and air circulation

For air-cooled appliances, the maximum ambient temperature for operation is 90°F / 32°C. Correct operation cannot be guaranteed at higher temperatures. The machine may operate safely to a maximum temperature of 100°F / 38°C. Remote condensing units may be installed indoors next to the unit or within 25 ft. Consult Delfield if placement will be greater than 25 ft. away. Remote condensing units may also be installed outdoors but require a U.L. listed enclosure which is supplied as an option from Delfield. Sufficient air circulation must be guaranteed at all times.

2.4 Electrical connections

A dedicated thermal-magnetic circuit breaker compliant with established regulations must be installed on the appliance power line.

- Connected electrical cables must correspond to the technical data (as specified on electrical drawings provided by the installation technician).
Connect the earthing conductor to an efficient earthing system.

THE MANUFACTURER DECLINES ALL LIABILITY AND GUARANTEE OBLIGATIONS IN THE EVENT OF INJURY TO PERSONS OR DAMAGE TO EQUIPMENT AND OBJECTS DUE TO INCORRECT INSTALLATION AND/OR FAILURE TO COMPLY WITH STANDING INSTALLATION REGULATIONS.

2.6 Condensate drainage connection

For models T20C-T24C-T40 fit a condensate water drainage hose with a minimum diameter of 1". Provide a waste pipe with a trap with a diameter of at least 1 1/2" at floor level.

2.7 Information for the installation technician

Before starting up the machine, check that it has been correctly installed.

1. Check that there are no gas leaks from weldings or joints made during installation works.
2. Check that the pipes connecting the condenser to the remote condensing unit have been well insulated.
3. Check all wiring connections.
4. Check electrical input.
5. Check the standard pressure in the refrigerant system.
6. Perform at least one blast freezing cycle (to the SET temperature) and one manual defrosting cycle. In the event that the appliance or the remote condensing unit have not been transported in a vertical position (e.g. on the back) or have been overturned during installation works, allow at least 4 hours before starting up the equipment.

2.8 Safety and control systems

- Door microswitch: shuts down fan operation in the cell when the door is opened.
- General fuses: protect the power circuit against short circuiting and overloads.
- Compressor heat relay: intervenes in the event of overloads or operating faults.
- Safety pressure switch: intervenes in the event of excessive pressure in the refrigerant circuit.
- Plug fuses: intervene in the event of overpressure or operating fault in the safety pressure switch (see above).
- Chamber temperature control: operated by the electronic board by means of a probe inside the cell.
- Temperature control end defrost cycle: controlled by the electronic board by means of the probe in the evaporator.

2.9 Appliance disposal

After the useful life of the appliance has been realized, be sure to demolish and dispose of the machine in compliance with the regulations applied in the country of installation, particularly in regards to refrigerant gas and compressor lubricant oil.

3. ADVICE TO ENSURE EFFICIENT APPLIANCE OPERATION

3.1 Shut-down procedures

In the event of emergency, shut down the appliance by switching off power at the main panel, by means of a breaker or power disconnect or by removing the plug from the power socket.

3.2 Operating tips

Before starting up the appliance, clean the inside of the compartment thoroughly.

3.2.1 Pre-cooling

Before using the appliance for the first time, or after a prolonged period of disuse, precool the compartment by running an empty cycle until the set operating temperature has been reached.

To ensure optimal performance without any alteration to food quality: arrange food products in such a way as to favour the circulation of cold air throughout the compartment; open the door as little as possible.

3.2.2 Loading the appliance

a) Ensure that foods to be chilled and/or frozen are separate and do not have a thickness greater than 2"/50mm-3"/80mm. Do not load the appliance beyond the quantity recommended by the manufacturer.

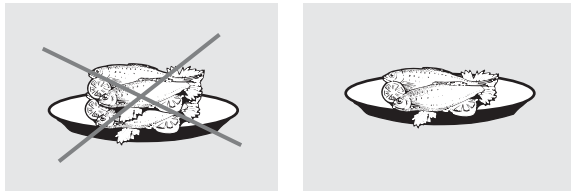

b) Ensure that there is sufficient clearance between trays to enable free air circulation. If the appliance is not completely full, distribute the trays and foods evenly throughout the available space.

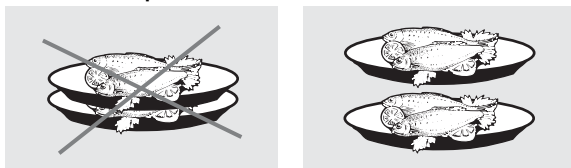

c) Position trays inside the tray compartment as far as they will go, as close as possible to the evaporator.

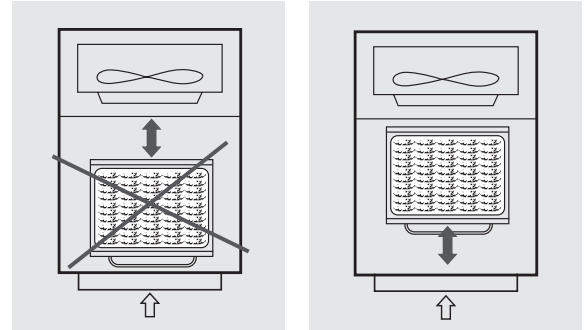

d) Position the core probe at the centre of the largest product or food item; make sure that the tip of the probe does not protrude or touch the tray. The probe must be cleaned and sanitised before each new cycle (operation) to prevent inadvertent contamination.

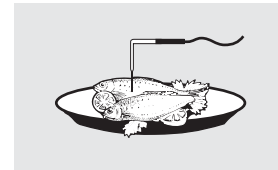



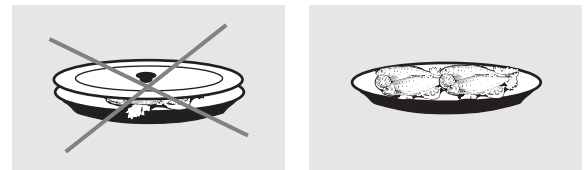



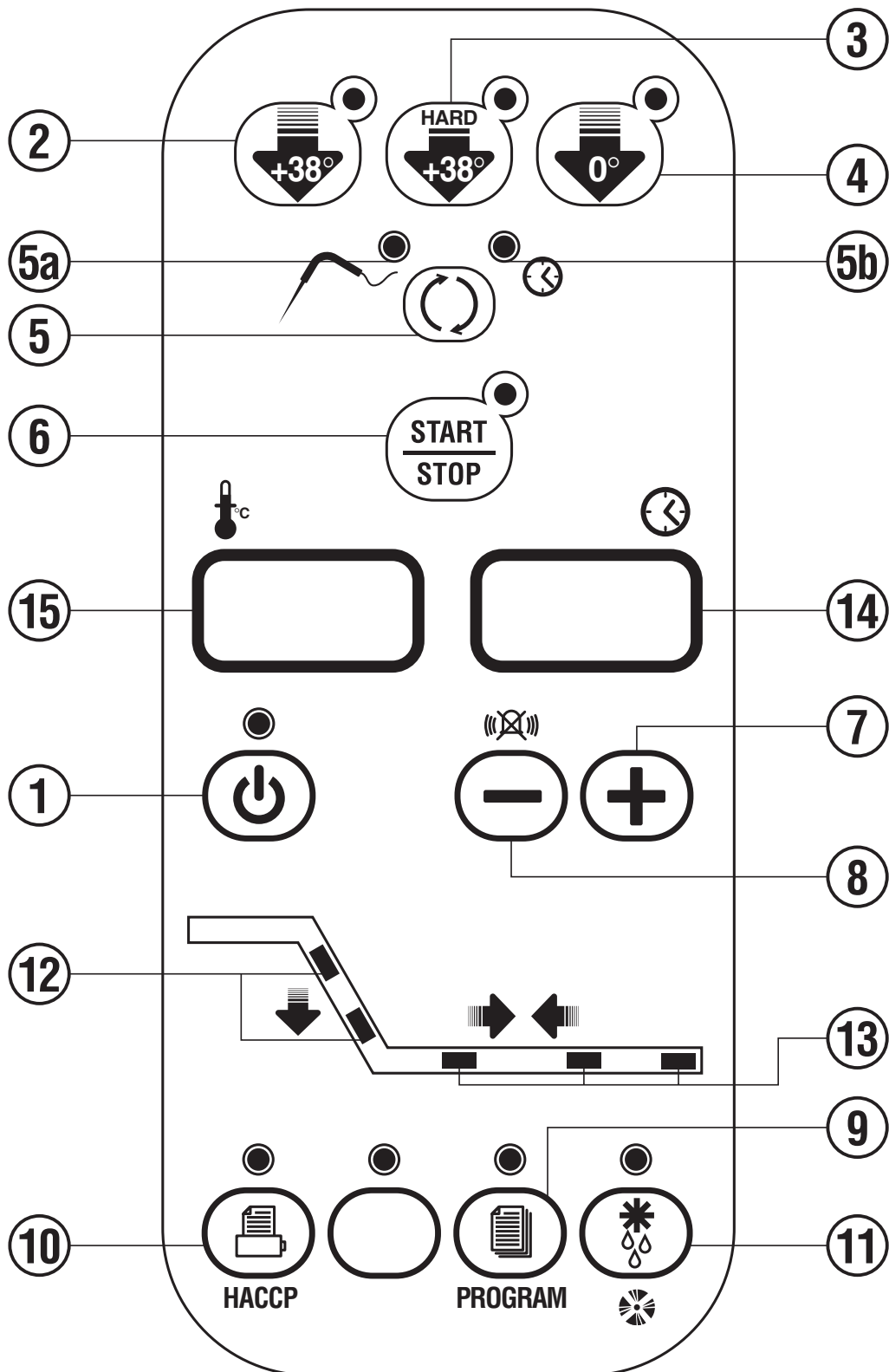









e) Avoid covering the trays and/or containers with insulating covers or film. The more the product is insulated, the more time is required for chilling or freezing. Trays should be packaged when the product has been chilled, before being placed in storage.



4. DESCRIPTION OF THE VERTICAL CONTROL PANEL



4.1 PUSH-BUTTONS :

1.  ON /OFF (STAND BY)
2.  SOFT BLAST CHILLING CYCLE (+38°F / +3°C)
3.  HARD BLAST CHILLING CYCLE (+38°F / +3°C)
4.  BLAST FREEZING CYCLE (0°F / -18°C)
5.  END CYCLE BY TIME / PROBE (TEMPERATURE)
- 5A.  PROBE CHILLING INDICATOR LED
- 5B.  TIMED CHILLING INDICATOR LED
6.  CYCLE START / STOP
7.  INCREASE VALUE
8.  DECREASE VALUE
9.  RECIPE PROGRAMS (CHILLING CYCLES)
10.  HACCP AND PRINTER (OPTIONAL)
11.  DEFROSTING / FORCED VENTILATION
12.  CHILLING / FREEZING CYCLE INDICATOR LED
13.  STORAGE INDICATOR LED
14.  TIME DISPLAY
15.  TEMPERATURE DISPLAY

5. PROGRAMMING AND OPERATING INSTRUCTIONS

5.1 STARTING UP THE APPLIANCE (only for T14D / T20C / T24C / T40)



WARNING !!!
THESE OPERATIONS MUST BE PERFORMED
BY A CERTIFIED INSTALLATION
TECHNICIAN ONLY.





PRE HEATING FUNCTION OF COMPRESSOR SUP

When power is initially supplied to the cabinet, a 2-hour pre-heating phase starts and the display shows some blinking dashes "----". During this phase the machine cannot be started. This important information is shown on a yellow label placed inside the door.

Initial pre-heating is necessary in order to safeguard the compressor's life. Only if strictly necessary (and under the customer's responsibility) it is possible to by-pass countdown by pressing push button "Printer/HACCP" for about 5 seconds.

This function is not activated if machine stops/starts operating due to lack of power during working cycle.

When the appliance is powered up, it can be:

- **ON** displays 15  and 16  and left LED 5A  on push-button 5  on, LED 1  off

- **OFF-STAND-BY LED** on push-button 1  on

To switch from one status to another, press push-button 1 .

Whenever the appliance switches from STAND-BY status to ON, a self-test is carried out: all LEDs and displays are switched on, push-buttons are checked, then the installed software version is displayed.

OPERATION

The main work cycles (chilling/freezing) performed by the appliance:

- **SOFT BLAST CHILLING (+38°F / +3°C)**

Pre-cooked food is rapidly chilled (90') to a temperature of +38°F / +3°C, thus preventing proliferation of bacteria and preventing dehydration of the cooked food due to evaporation. Food can thus be stored perfectly for 5 to 7 days without altering its original qualities. The soft cycle is recommended for delicate, thin foods such as rice, vegetables and fried foods.

- **HARD BLAST CHILLING (+38°F / +3°C)**

This process is designed to cool food products with a thickness greater than 2-3 cm/1" and is very effective for dense, greasy or large-sized foods. Variable air temperatures are used to accelerate penetration of cold into the product.

- **BLAST FREEZING (0°F / -18°C)**

This function freezes the product completely to a temperature of 0°F / -18°C in approximately 4 hours. The rapidity of the process prevents formation of macrocrystals essential to ensure that the product retains its original consistency and quality when thawed for consumption.

- **AUTOMATIC CONSERVATION**

At the end of each cycle (chilling or freezing), the appliance will automatically switch to the required storage temperature.



Two different end-cycle modes are available for each cycle:

- **BY TEMPERATURE** - the cycle ends when the probe reaches the required temperature.
- **TIMED** - cycle length is pre-set

IMPORTANT: work cycles and modes can only be selected when the appliance is ON (LED on push-button 6  off)

IMPORTANT: The appliance will automatically defrost if coil temperature falls below 45°F. It will not go into defrost during a chill or freeze cycle. When it is in defrost a new cycle can not be initiated until defrost is complete.

5.2 SOFT BLAST CHILLING BY TEMPERATURE (pre-cooked, hot foods)

• To select this cycle, press push-button 2  (relative LED lights up), then press push-button 5  to select the temperature mode (LED 5A  on)

• Insert the core probe into the core of the product to be chilled.





• Start up the cycle by pressing push-button 6 . LED 5A  and those related to the push-buttons pressed illuminate throughout the cycle, while LEDs 12  flash.

• Display 15  indicates the maximum blast chilling time (starting temperature to end of the blast chilling temperature (factory setting 90 minutes).

• The temperature measured by the core probe is shown by display 16 .

• The instrument timer starts the countdown of the maximum blast chilling time as soon as the temperature measured by the core probe falls below the temperature of +149°F / +65°C (the dot at the bottom right of display 15  flashes).

• During the blast chilling cycle, the air temperature is around +32°F / 0°C and may get as low as 23°F/-5°C. This function is designed to guarantee uniform cooling of the product, preventing frost formation on the surfaces. During the blast chilling cycle, the compressor may therefore stop and restart, depending on the reading of the compartment temperature probe.

• The blast chilling phase ends only when the core probe (inserted in the product core) indicates that the set blast chilling temperature (+38°F / +3°C) has been reached as signalled by an intermittent beep for a minute. During the beep, LEDs 13  and 14  flash. Display 16  indicates the temperature inside the compartment, while display 15  shows blast chilling time reset to zero.



• If at the end of the maximum blast chilling interval the core probe continues to display a temperature higher than the value for the end of blast chilling, the displays will indicate an alarm for excessively long chilling (ALL 14) alternating with the temperature and time; at the same time, the alarm beep will be activated.

The blast chilling cycle continues until the end chilling temperature has been reached; display 15  counts back the minutes remaining until the end of the cycle.

Press push-button 8  to mute the alarm; press push-button again to clear the alarm display.

- At the end of the chilling cycle, the appliance automatically switches to the set storage temperature for an indefinite interval (like a standard storage appliance).

LEDs 13  switch off while LEDs 14  light up.





- The compartment temperature is constantly shown on display 16;  during this cycle, defrost cycles are performed at regular intervals with duration set as required (parameter programming reserved for installation technician). The factory setting for positive storage temperature is +36°F / +2°C.
- Press push-button 6  to set the appliance to STOP status (relative LED switches off), ready for a new cycle.

To modify the final blast chilling temperature, consult the user programming instructions.



IMPORTANT: During chilling or shock freezing by core sensor it's possible to read:

- The room temperature by pressing push button
- The evaporator temperature by pressing push button

5.3 SOFT TIMED BLAST CHILLING

- Press push-button 2  (relative LED lights up), then press push-button 5  to select the timer mode (LED 5B  on). Display 15  shows the maximum chilling time (set by default to 90 minutes).

To modify this time, press push-buttons 7  and 8  (time in minutes).

- Press push-button 6  to start the appliance. LED 5B  and push-button LEDs remain on and LEDs 13  flash throughout the cycle.

Internal cell temperature is shown on display 16 .

- When the maximum chilling time has counted back to 0, the chilling cycle is completed and the appliance automatically switches to the set positive storage temperature for an indefinite interval.

- LEDs illuminate and the beep is activated when the cycle is finished (as in the chilling cycle by temperature). The same applies for the positive storage function.

Press push-button 6  to set the appliance to STOP status (relative LED switches off), ready for a new cycle.

IMPORTANT: Use the storage function sparingly. After chilling, food products should be placed in storage cabinets.

















HARD BLAST CHILLING

When the HARD function is used, chilling takes place in two stages:

- an initial "Hard" stage when the air temperature is brought down to below 32°F / 0°C in order to accelerate chilling;
- a second "Soft" stage, involving air temperatures around 32°F.

IMPORTANT: During chilling or shock freezing by time it's possible to read the evaporator temperature by pressing push button

5.4 HARD BLAST CHILLING BY TEMPERATURE

- Press push-button  3 (relative LED lights up), then press push-button 5  to select the temperature mode (LED 5A  on). Insert the core probe into the core of the product to be chilled.
- Start up the cycle by pressing push-button 6 . LED 5A  and those relative to the push-buttons pressed illuminate throughout the cycle, while LEDs 13  flash.
- Display  15 indicates the maximum blast chilling time (starting temperature to end of the blast chilling temperature - factory setting - 90 minutes).
- The temperature measured by the core probe is shown by display 16 .
- The instrument timer starts the countdown of the maximum blast chilling time as soon as the temperature measured by the core probe falls below the temperature of +149°F / +65°C (the dot at the bottom right of display 15  flashes).
- Once the cycle has been started, the appliance operates initially with an air temperature below +32°F / 0°C (LED on push-button 3  flashes), then with temperatures around +32°F / 0°C (LED on push-button 3  on). The first stage of the cycle is completed when the core probe detects a temperature of +68°F / +20°C in the product core.
- The blast chilling phase ends only when the core probe (inserted in the product core) indicates that the set blast chilling temperature (+38°F / +3°C) has been reached as signalled by an intermittent beep for a minute. During the beep, LEDs 13  and 14  flash. Display 16  indicates the temperature inside the cell, while display 15  shows blast chilling time reset to zero.
- The alarm (ALL 14) and conservation functions cut in with relative indicators in the same way as for timed Soft blast chilling.
- Press push-button 6  to set the appliance to STOP status (relative LED switches off), ready for a new cycle.

IMPORTANT









HARD blast chilling affords a considerable reduction in working time, and is particularly suited to foods with a high fat content, for large pieces or for packaged products.



SOFT chilling is recommended for delicate and finely chopped products, such as vegetables, mousses, etc..

IMPORTANT: During chilling or shock freezing by core sensor it's possible to read:

- The evaporator temperature by pressing push button



5.5 HARD TIMED BLAST CHILLING

- To select this cycle, press push-button 3  (relative LED lights up), then press push-button 5  to select the "timed" mode (LED 5B  on). Display 15  shows the maximum chilling time (set by default to 90 minutes).
To modify this time, press push-buttons 7  and 8  (time in minutes).
- To set the time of the first negative temperature stage, press push-button 3  for five seconds, then wait for display 15  to show the flashing value.

The time setting (in minutes) can be modified by means of push-buttons 7  and 8 . Press push-button 3  again to return to standard display.

- Start up the cycle by pressing push-button 6 . LED 5B  and push-button LEDs remain on and LEDs 13  flash throughout the cycle.

- Internal cell temperature is shown on display 16 .

- Once the cycle has been started, the appliance operates initially with an air temperature below +32°F / 0°C (LED on push-button 3  flashes), then with temperatures around +32°F / 0°C (LED on push-button 3  on). For example: HARD timed chilling cycle 90 minutes. First stage of 40 minutes with negative air temperature. Second cycle stage of 50 minutes with air temperature around +32°F / 0°C.





- When the maximum chilling time has counted back to 0, the chilling cycle is completed and the appliance automatically switches to the set positive storage temperature for an indefinite interval.



- LEDs illuminate and the beep is activated when the cycle is finished (as in the temperature chilling cycle). The same applies for the storage function.

- Press push-button 6  to set the appliance to STOP status (relative LED switches off), ready for a new cycle.

IMPORTANT: During chilling or shock freezing by time it's possible to read the evaporator temperature by pressing push button

5.6 BLAST FREEZING BY TEMPERATURE

- To select this cycle, press push-button 4  (relative LED lights up), then press push-button 5   to select the temperature mode (LED 5A  on). Insert the core probe into the core of the product to be chilled.

- Start up the cycle by pressing push-button 6 . LED 5A  and those relative to the pushbuttons pressed illuminate throughout the cycle, while LEDs 13  flash.

- The appliance proceeds to operate in the same way as that described for the positive chilling cycle. During this cycle the compressor operates in continuous mode to enable the appliance to reach the cycle end temperature in the shortest time possible (default temperature at product core is set at 0°F / -18°C). Maximum freezing time is 240 minutes.







- The alarm (ALL 14) for excessively-long freezing and conservation functions cut in with relative indicators in the same way as for timed Soft blast chilling. The factory setting for negative storage temperature is -13°F / -25°C.





- LEDs illuminate and the beep is activated when the cycle is finished (as in the soft chilling cycle by temperature). The same applies for the storage function. Press push-button 6  to set the appliance to STOP status (relative LED switches off), ready for a new cycle.

IMPORTANT: During chilling or shock freezing by core sensor it's possible to read:

- The evaporator temperature by pressing push button 

5.7 TIMED BLAST FREEZING

• Press push-button 4  (relative LED lights up), then press push-button 5  to select the timer mode (LED 5B  on). Display 15  shows the maximum chilling time (set by default to 240 minutes). To modify this time, press push-buttons 7  and 8  (time in minutes).

• Start up the cycle by pressing push-button 6 . LED 5B  and push-button LEDs remain on and LEDs 13  flash throughout the cycle. Internal cell temperature is shown on display 16 .

• When the maximum chilling time has counted back to 0, the cycle is completed and the appliance automatically switches to the set negative storage temperature for an indefinite interval. LEDs illuminate and the beep is activated when the cycle is finished (as in the freezing cycle by temperature). The same applies for the storage function. The factory setting for negative storage temperature is -13°F / -25°C.

• Press push-button 6  to set the appliance to STOP status (relative LED switches off), ready for a new cycle.





IMPORTANT: During chilling or shock freezing by time it's possible to read the evaporator temperature by pressing push button .

6. APPLIANCE FUNCTIONS

6.1 DATE AND TIME SETTINGS :

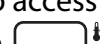
PUSH-BUTTON (5)

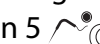



Set the machine to ON .

Press and hold down push-button 5  for more than five seconds to access the date and time setting function. Display 16  indicates in sequence the abbreviations Hr (hours), Mn (minutes), dA (day), Mo (month) and Yr (year), while display 15  shows their respective settings. To scroll the abbreviations, press push-button 5 . To modify the settings, use push-buttons 7  and 8 .

6.2 ICE CREAM SURFACE HARDENING

PUSH-BUTTON (6)

Set the machine to ON .

Press and hold down push-button 6  for more than five seconds to access the surface hardening function (push-button LED flashes). The compressor is switched on; display 15  shows the default cycle time. Set the cycle time (in minutes) by means of push-buttons 7  and 8 . Open the cell door, place the product inside, then shut the door to start the cycle. All LEDs remain off, with the exception of the Start LED. When the cycle time has elapsed, an acoustic signal is given. The appliance remains on, ready for another ice cream hardening cycle. Open the cell door, remove the hardened product, replace it, then shut the door. The machine will perform another hardening cycle for the time set for the previous one. Every time the door is opened and closed after a cycle, the time is reset. To exit the function, press push-button 6 .



ADDITIONAL FUNCTIONS

6.3 MUTING THE BEEPER AND ALARM

RESET : PUSH-BUTTON (8)



Press push-button 8  to mute the alarm beeper.





Alarms are reset :

- by pressing push-button 8  when the beeper is off;
- automatically if alarm conditions are removed; see also section 7  (Alarm Management).

6.4 PROGRAM STORAGE:







PUSH-BUTTON (9)

The programming function is used for cycles for processing products with the same characteristics. Up to 99 programs can be stored. Select the type of chilling process (Soft, Hard, Timed Freezing or by Temperature), then press and hold push-button 9  until display 16  shows the abbreviation P1 (push-button 9  LED flashes).

Use push-buttons 7  and 8  to set the number of the program on display 16 . Start up the cycle by pressing push-button 6 . When the cycle has been completed, the appliance automatically switches to the set storage temperature for an indefinite time.

Press push-button 6  to set the appliance to STOP status (relative LED switches off), ready for a new cycle.

RECALLING A STORED PROGRAM

When the appliance is ON , press push-button 9  briefly; display 16  will show program P1. Use push-buttons 7  and 8  to select the required program. Start up the cycle by pressing push-button 6 .

6.5 DISPLAYING THE THREE LATEST HACCP ALARMS (PUSH-BUTTON 10)



Set the machine to **ON** .

Press and hold down push-button 10  for more than five seconds (relative LED illuminates) to enter the alarm display function (date, hour and minute, alarm type and maximum temperature detected). Every time the HACCP push-button is pressed, the stored data are displayed.



EXAMPLE:

ALL.11	Display 15	Display 16
	---	Str (start)
	12	hr hour
	29	min minutes
	6	day days
	8	mon month
	03	yr year
	End	end
	13	Hr
	21	min
	6	day
	8	mon
	03	yr
	75	maximum temperature detected inside the cell

6.6 PRINTING OUT STORED DATA PUSH-BUTTON (10)



With the appliance in STAND-BY status, press and hold down push-button 10  for more than five seconds to print out the latest work cycle. (With the appliance in STAND-BY status, press push-button 10  once to print out HACCP data). When the appliance is operating and the printer is on, the current cycle will be printed out.

6.7 FORCED VENTILATION FUNCTION

To activate this function when the appliance is ON , press push-button 12  for more than five seconds. The fan will continue to operate even when the cell door is open.

During forced ventilation, display 16  will show "DEF".

6.8 MANUAL DEFROSTING

To activate this function when the appliance is ON , press push-button 12  (relative LED illuminates).

If conditions allow it (the temperature detected by the evaporator probe must be lower than the set point in the program parameters), the appliance will perform a defrost cycle. Display 16  will show "DEF".

To immediately stop a defrost cycle, press push-button 12 .

6.9 AUTOMATIC DEFROST CYCLES

The appliance automatically performs defrost cycles during storage. Three defrost cycles are performed during a 24-hour period (once every 8 hours). The appliance automatically restarts once the defrost cycle has been completed.

6.10 PRINTER OPERATION

If you have to turn the instrument ON/OFF press **ON/OFF**

If you have to feed the paper by hand press **feed**. If you have to change the roll of paper, turn the instruments off, press the push bottom for opening the panel at the front of the instrument. Slip the roll of paper into the lower side of the roller press **feed** as long as the roller drags the roll of paper.

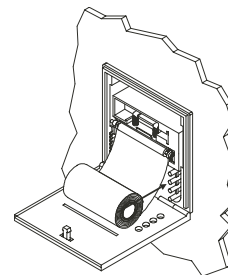

Put the roll of paper into it's box

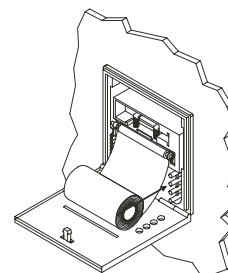

Close the panel at the front of instruments.

7. ALARM MANAGEMENT

7.1 Storage of data/errors

The appliance electronic controller is equipped with a system of acoustic and visual signals to indicate the intervention of safety devices. The table below gives a list of the alarms shown on the panel display

7.2 The software controls the following alarms:

Evaporator probe alarm (ALL 01)

Cause:	Exit from operating range (-58°F / -50°C - 212°F / +100°C) for over 30 seconds. Probe is defective (REPLACE PROBE).
Beeper:	Activated (3 seconds, then a pause of 30 seconds) until the mute button is pressed.
Display:	Alternates message "ALL 01" with standard display
Reset:	Automatically resets only when probe reading has returned to normal.

Core probe alarm (ALL 02)

Cause:	Exit from operating range (-58°F / -50°C - 212°F / +100°C) for more than 30 seconds during current chilling cycle by temperature.
Effect:	Interruption of current chilling cycle by temperature and automatic start-up of timed chilling cycle. Chilling by temperature push-button disabled. Probe is defective (REPLACE PROBE).
Beeper:	Activated (3 seconds, then a pause of 30 seconds) until the mute button is pressed.
Display:	Alternates message "ALL 02" with standard display
Alarm relay:	Not activated.
Reset:	Press the mute push-button (with beeper off). Resets automatically if probe value returns to normal, but cycle remains in timed mode. Alternatively, switch off the panel then turn it back on (stand-by).

Compartment probe alarm (ALL 03)

Cause:	Exit from operating range (-58°F / -50°C - 212°F / +100°C) for over 30 seconds. Probe is defective (REPLACE PROBE).
Effect:	Any current chilling cycle is interrupted. If a storage phase is in progress, the compressor and the fan set to stand-by status. When the appliance is in Stop status, press Start to set the compressor and fan to stand by.
Beeper:	Activated (3 seconds, then a pause of 30 seconds) until the mute button is pressed.
Display:	Alternates message "ALL 03" with standard display
Reset:	Automatically resets only when probe reading has returned to normal.

Input SW2 (ALL 05) (door microswitch alarm)

Cause:	Input active for more than 5 minutes with appliance in start status. Door open (close door) Microswitch fault (replace the microswitch)
Beeper:	Activated (3 seconds, then a pause of 30 seconds) until the mute button is pressed.
Display:	Alternates message "ALL 05" with standard display
Reset:	Press the mute push-button (with beeper off). Automatically resets if input value returns to normal Alternatively, switch off the panel then turn it back on (stand-by).

Input SW1 alarm (ALL 06) (T5 and T14D models only) (High pressure switch) for all models (Compressor thermal-magnetic switch) if installed (Oil diff. pressure switch) if installed

Cause:	Input active for more than 5 seconds
Effect:	Sets the appliance to STOP. Reset the max. pressure switch, thermal-magnetic switch or differential pressure switch.
Beeper:	Activated (3 seconds, then a pause of 30 seconds) until the mute button is pressed.
Display:	Alternates message "ALL 06" with standard display
Reset:	Press the mute push-button (with beeper off) with no alarm cause displayed

Input SW3 alarm (ALL 08) (Kriwan compressor automatic reset) only for T14D (Thermostat on the discharge line)

Cause:	Input active for more than five seconds at least three times when appliance is in start mode
Effect:	Compressor shuts down and resumes operation when input value returns to normal. The appliance sets to STOP at third alarm.
Beeper:	Activated (3 seconds, then a pause of 30 seconds) until the mute button is pressed.
Display/Led:	Alternates message "ALL 08" with standard display
Reset:	Press the mute push-button (with beeper off). Alternatively, switch off the panel then turn it back on (stand-by).

Input Ht1 alarm (ALL 09) (Input in voltage 1 ... fuses).

Input Ht2 alarm (ALL 10) (Input in voltage 2 ... fuses)

Excessive temperature alarm (ALL 11)

Cause: (only during storage) cell probe constantly detects a temperature greater than the sum of positive or negative storage set points with relative alarm delta.

Blackout alarm (ALL 12)

Cause: (only during storage) after the return of power the cell probe detects a temperature greater than the sum of positive or negative storage set points with relative alarm delta. This alarm is disregarded if the storage probe is already in alarm status.

Compressor preventive maintenance alarm (ALL 13)

Cause: Compressor operating time is a whole multiple of hours set under password.

Temperature not reached in set time alarm (ALL 14)

Cause: Blast chilling by temperature has lasted longer than the time set for Timeout

Effect: Store the alarm in HACCP memory
Chilling cycle continues.

Beeper: Activated (3 seconds, then a pause of 30 seconds) until the mute button is pressed.

Display: Alternates message "ALL 14" with standard display
Alarm relay: Not activated.

Reset: Press the mute push-button (with beeper off).
Alternatively, switch off the panel then turn it back on (stand-by).

Keyboard/membrane alarm (ALL 15)

Cause: A pressed push-button has been detected when panel is switched on.

Effect: All keys are disabled.
All relays are disabled. All inputs are disregarded. The LED indicator of the pressed button flashes.

Beeper: Activated (3 seconds, then a pause of 30 seconds) until the mute button is pressed.

Display: Alternates message "ALL 15" with standard display

Reset: Switch off the panel then turn it back on (stand-by).

NB: The appliance cannot be used until this alarm has been removed.

INFORMATION ON ALARMS:

During alarms, the beeper is activated and the display shows the message "ALL xx".

The alarm message is alternated on the display even when the beeper has been silenced, until the alarm has been cleared.

Alarm relays remain activated as long as the alarm is displayed.

In the case that more than one alarm has been activated, each one is alternately displayed.

When the beeper is activated, the operator can silence it by pressing the relative push-button, after which the alarm can be cleared, by pressing the beeper reset button again.

Power failures will not erase current alarms.

List of other operating faults not indicated:

FAULT	CAUSE	SOLUTION
Compressor does not operate	1 - Overload switch has cut in 2 - Power failure	1 - Seek assistance from a service technician 2 - Check connection to power lines
Fans do not rotate	1 - Power failure 2 - Fan fault 3 - Condenser fault 4 - Protective fuse faulty	1 - Check connection to power lines 2 - Seek assistance from a service technician to replace fan 3 - Seek assistance from a service technician to replace condenser 4 - Seek assistance from a service technician to replace fuse
Electronic panel does	1 - Power failure 2 - Protective fuses broken	1 - Check connection to power lines not switch on 2 - Seek assistance from a service technician to replace fuses
Compressor operates but does not cool cell	1 - Shortage of refrigerant gas 2 - Solenoid valve fault 3 - Condenser is soiled	1 - Seek assistance from a service technician 2 - Seek assistance from a service technician 3 - Clean the condenser (see par. 4.2)

8. MAINTENANCE AND CLEANING

The information and instructions given in this section address all persons operating the appliance: the user, the maintenance technician and non-specialised personnel.

Ensure that the electrical power to the system has been disconnected before carrying out any cleaning or maintenance work on the appliance.

8.1 GENERAL SAFETY REGULATIONS

Recall the following regulations to ensure that all cleaning and routine maintenance operations are conducted safely.

- do not touch the machine with moist or wet hands or feet;
- never operate the machine while barefoot; - do not insert screwdrivers, cooking utensils or any other object between the guards and moving parts.
- before performing cleaning or routine maintenance operations, disconnect the machine from the power supply at the master switch and by pulling out the plug;
- never pull on the power cable to disconnect the machine from the power supply.

Removal of guards and safety devices for the purposes of routine maintenance is strictly prohibited. The manufacturer declines all responsibility for accidents caused by failure to observe the above regulation.

Before starting up the appliance, clean the inside of the cell thoroughly, as described in par. 3.2.

8.2 CLEANING THE CONDENSER

To ensure correct and efficient air condenser operation, it must be kept clean to allow free circulation of air. This operation should be performed at least once a month.

Use a non-metal brush to remove all dust and debris from the condenser blades.

Use a vacuum cleaner to prevent the dust removed from being dispersed in the surrounding area. To remove greasy deposits, use a brush dipped in alcohol.

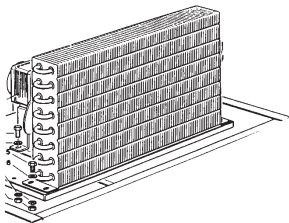

NEVER USE POINTED OR ABRASIVE INSTRUMENTS TO SCRAPE APPLIANCE SURFACES. PERFORM THIS OPERATION ONLY AFTER THE APPLIANCE HAS BEEN SHUT DOWN



WARNING !!!
THESE OPERATIONS MUST BE PERFORMED BY A CERTIFIED INSTALLATION TECHNICIAN ONLY.

IMPORTANT

The condenser has sharp edges. Always wear protective gloves, goggles and masks when carrying out the above operations.



8.3 CLEANING THE INTERNAL ROOM

To guarantee hygiene and ensure the quality of processed foods, clean the interior of the cell frequently, according to the type of food stored.

Weekly cleaning is recommended.

The interior and components can be cleaned with a soft cloth or sponge.

Clean with water and non-abrasive neutral detergents. Rinse with a damp cloth or sponge, or with a gentle jet of water. Do not use pointed or abrasive instruments to scrape appliance surfaces.



NEVER USE ABRASIVE FLUIDS, SOLVENTS OR THINNERS.

Always wear protective gloves while cleaning.

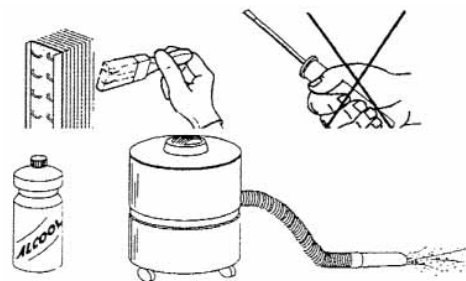

8.4 DEFROST WATER DRAINAGE

The system is prearranged for automatic and manual defrosting.

Make sure that the water from the evaporator drains out into a collecting tray, or provide a waste pipe with a trap having a discharger of at least 1 1/2" at floor level and that the drain tube is not clogged.

T5: Blast Chiller/Shock Freezer

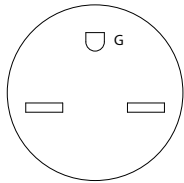
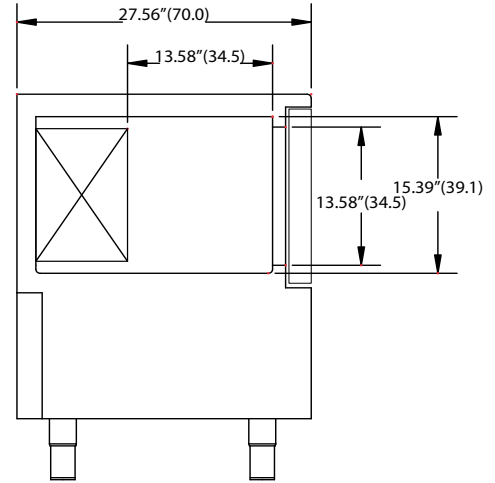
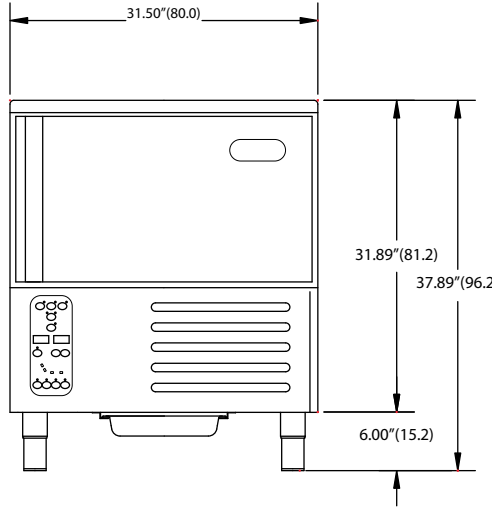

NEMA 6-15P
15 AMP 1-PHASE

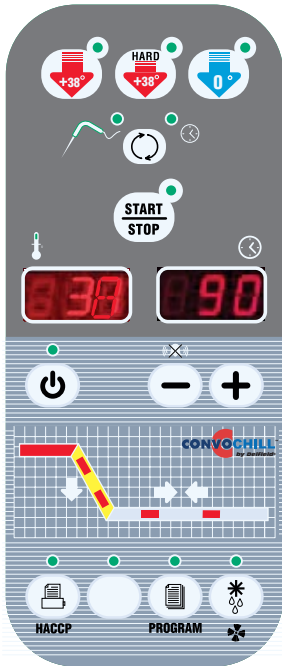

```

*****
*****
23:11 37°F Stop
23:05 37°F End Cycle
22:56 40°F
22:36 52°F
22:16 74°F
21:56 112°F
21:36 173°F Start
      T Core / Cuore
+3°C SOFT / TEMPERATURE
Program: Manual
Date: 18/08/2006
BLAST CHILLER T5
*****
*****
    
```

Sample Printout

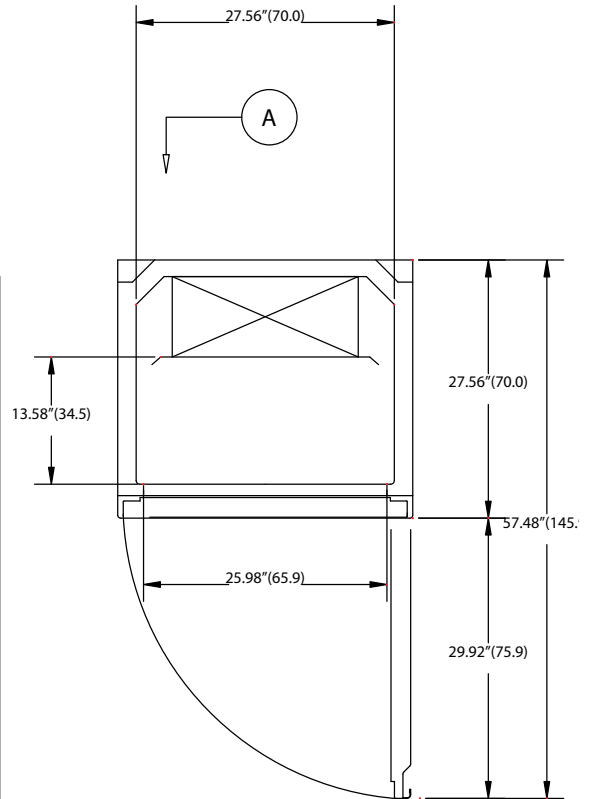

Model	Voltage	Comp. H.P.	Total Max Amps	Max Fuse Size	Average Heat Rejected (W)	Ship Weight
T5	220-230/1/60	.75	10.0	12.0	2,475	275

T14D: Blast Chiller/Shock Freezer

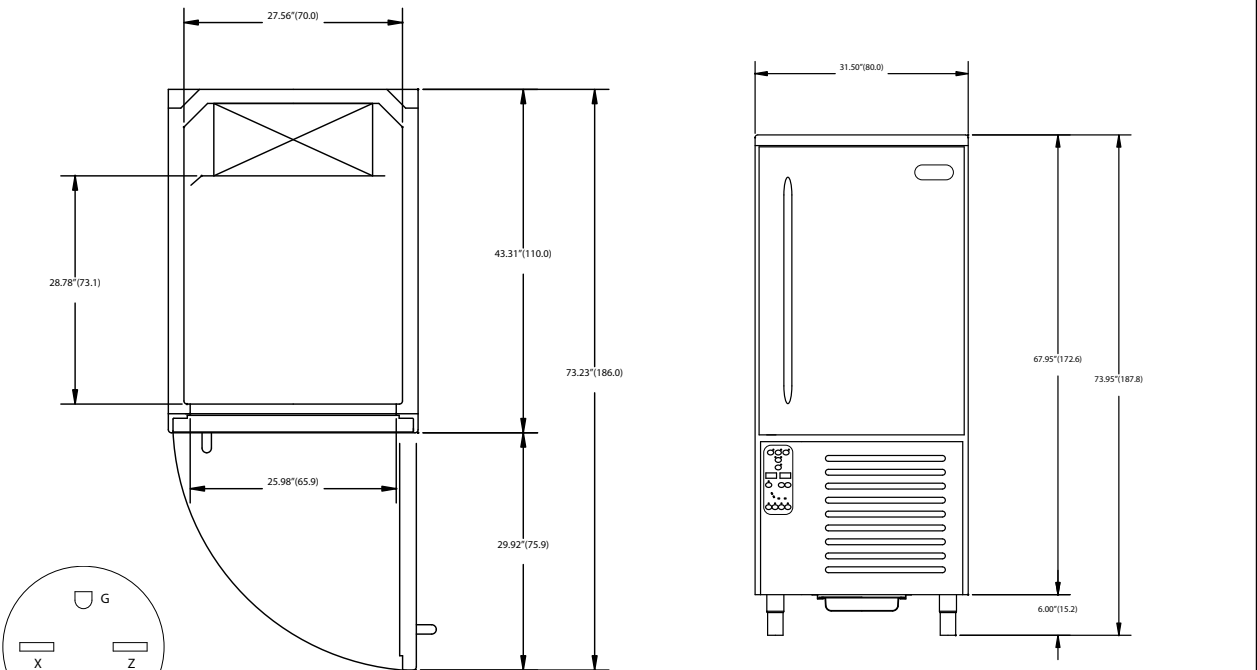

NEMA 15-30P
30 AMP 3-PHASE



```

*****
*****
23:11 37°F Stop
23:05 37°F End Cycle
22:56 40°F
22:36 52°F
22:16 74°F
21:56 112°F
21:36 173°F Start
      T Core / Cuore

+3°C SOFT / TEMPERATURE

Program: Manual

Date: 18/08/2006

BLAST CHILLER
*****
*****
    
```

Sample Printout

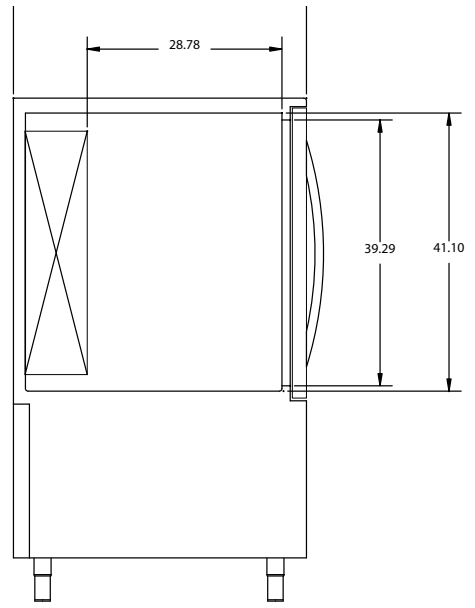

Model	Voltage	Comp. H.P.	Total Max Amps	Max Fuse Size	Average Heat Rejected (W)	Ship Weight
T14D	220-230/3/60	3.0	20.0	25.0	9,900	650

T20C: Blast Chiller/Shock Freezer

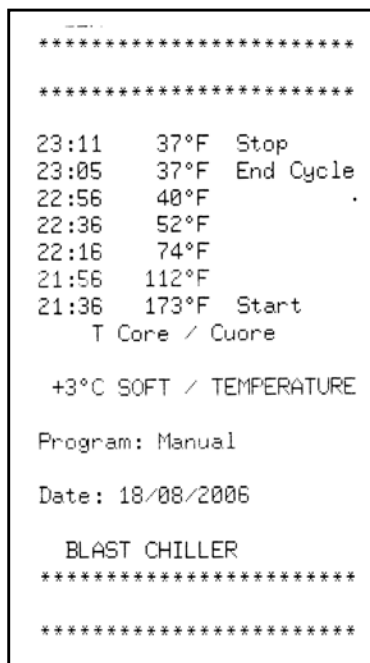
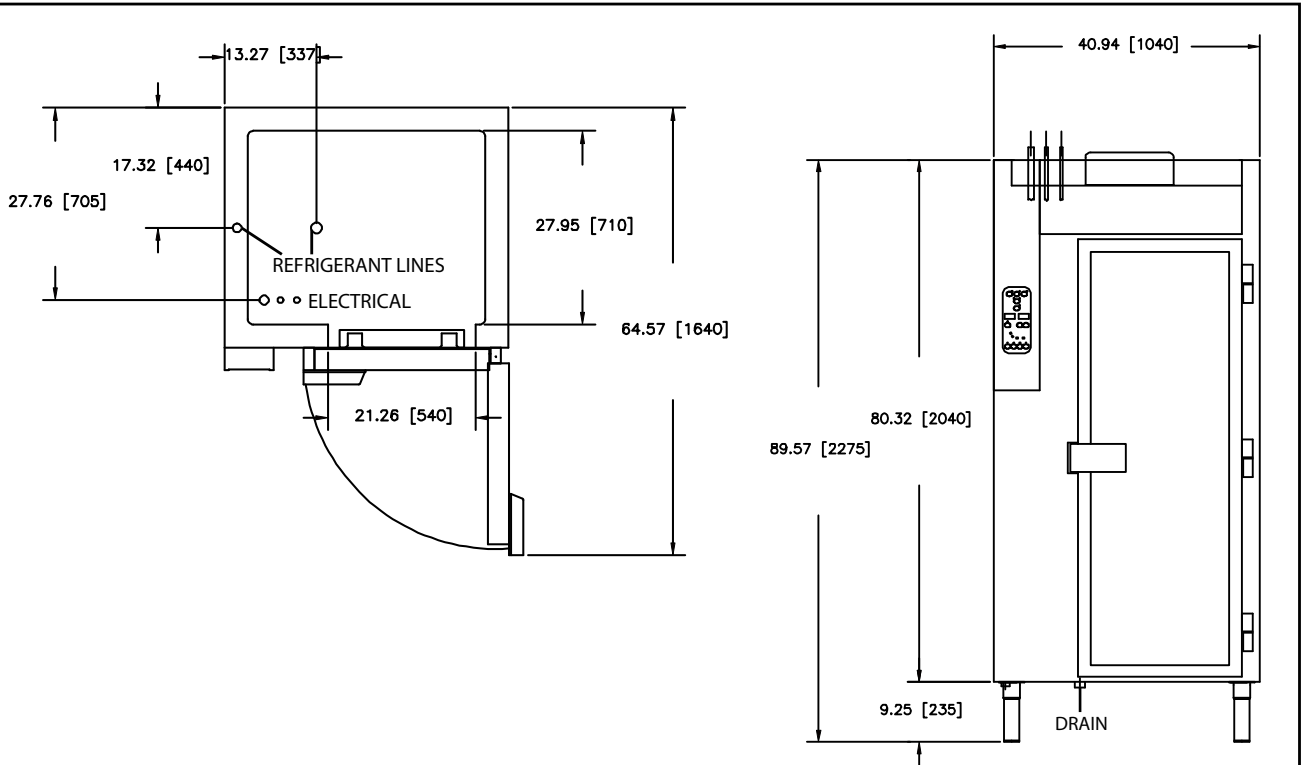

Sample Printout

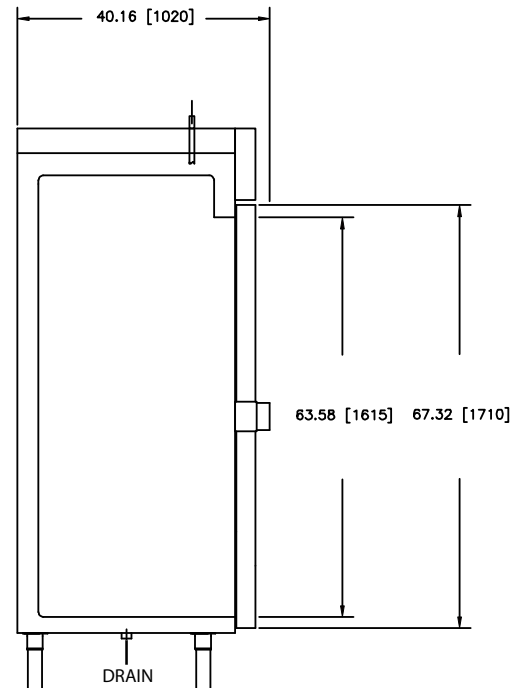

Model	Voltage	Max Fuse Size	Average Heat Rejected (W)	Ship Weight
T20C	220-230/1/60	15	12895	550 lbs.

T24C: Blast Chiller/Shock Freezer

49.21 [1250]
7.68 [195]
19.49 [495]
43.19 [1097]
REFRIGERANT LINES
ELECTRICAL LINES
76.38 [1940]
29.92 [760]

50.98 [1295]
60.24 [1530]
9.25 [235]
Drain

33.46 [850]
45.08 [1140]
Drain

```

*****
*****
23:11 37°F Stop
23:05 37°F End Cycle
22:56 40°F
22:36 52°F
22:16 74°F
21:56 112°F
21:36 173°F Start
T Core / Cuore

+3°C SOFT / TEMPERATURE

Program: Manual

Date: 18/08/2006

BLAST CHILLER
*****
*****

```

Sample Printout

Model	Voltage	Max Fuse Size	Average Heat Rejected (W)	Ship Weight
T24C	220-230/1/60	15	12895	550 lbs.

T40: Blast Chiller/Shock Freezer

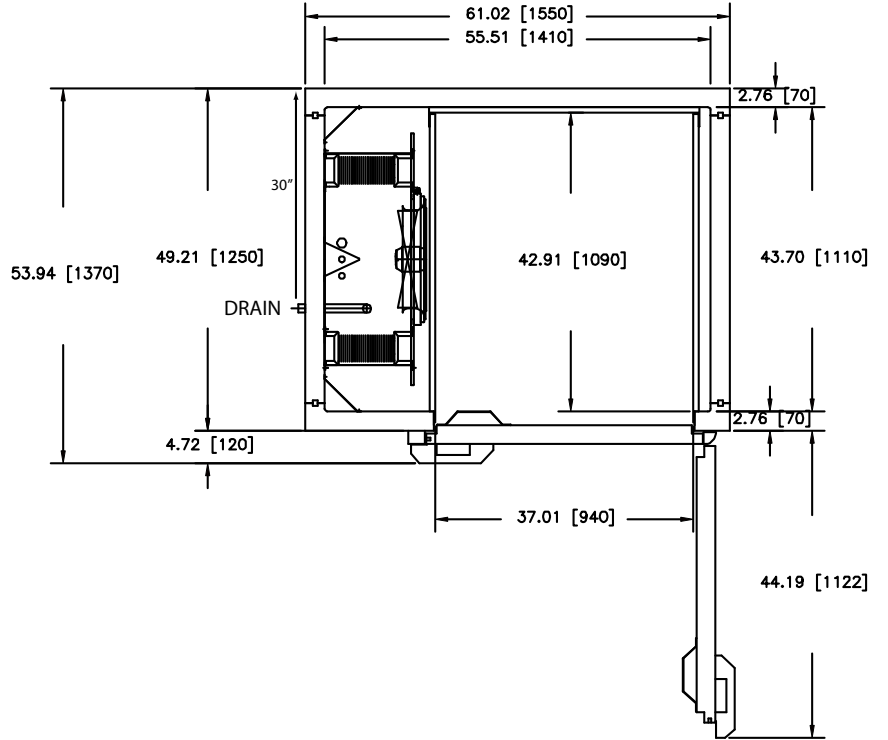

```

*****
*****
23:11 37°F Stop
23:05 37°F End Cycle
22:56 40°F
22:36 52°F
22:16 74°F
21:56 112°F
21:36 173°F Start
      T Core / Cuore
+3°C SOFT / TEMPERATURE
Program: Manual
Date: 18/08/2006
BLAST CHILLER
*****
*****
    
```

Sample Printout

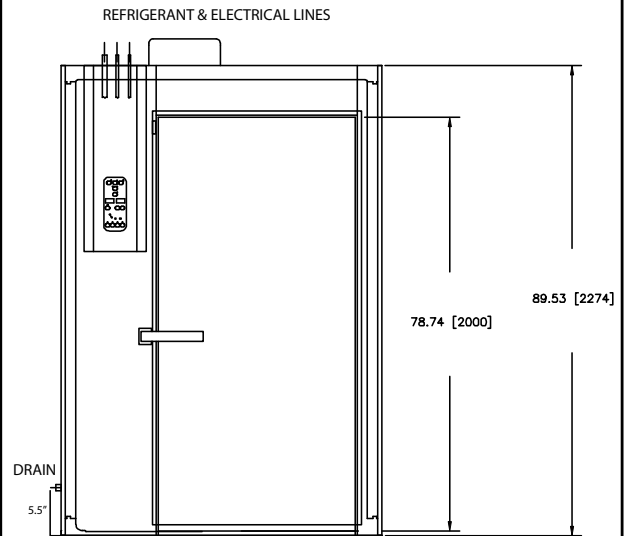

Model	Voltage	Max Fuse Size	Average Heat Rejected (W)	Ship Weight
T40	220-230/1/60	15	22330	850 lbs.

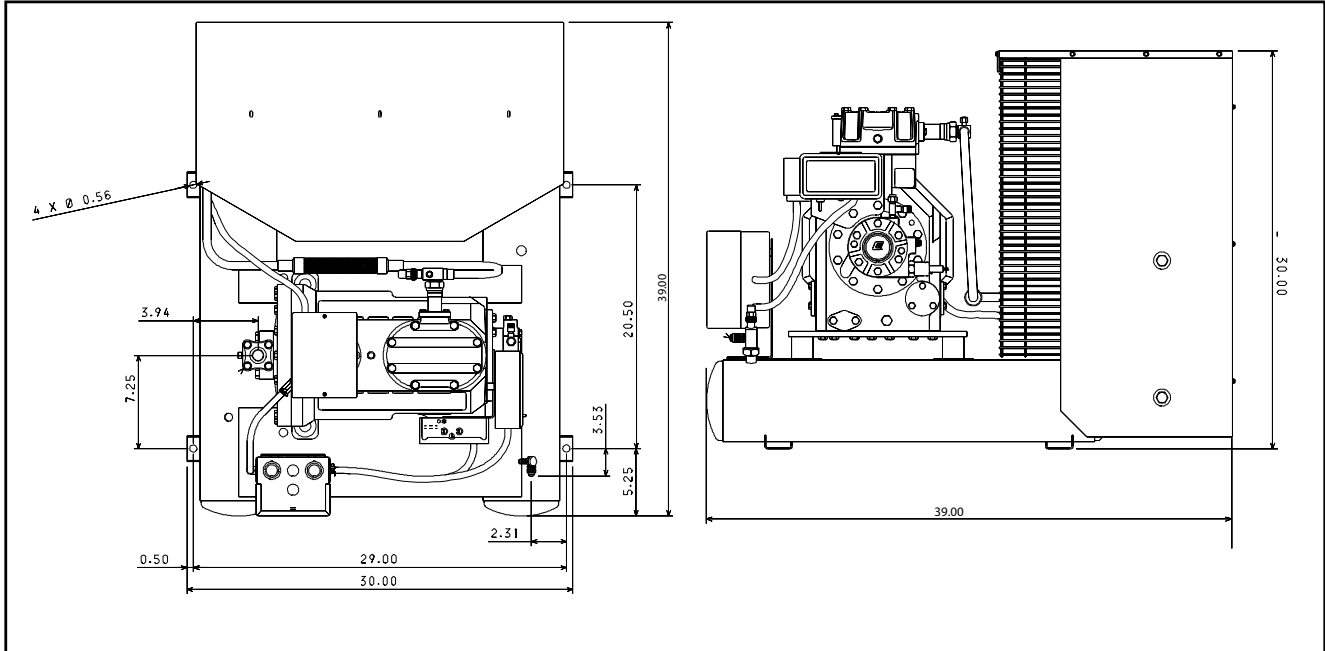

Ambient Operating Limits: -20°F to 120°F

Note: The Delfield Blast Chiller/Shock Freezer is wired independently of the remote condensing unit. No interconnecting wiring is required between the blast chiller and the condensing unit. All condensing units have units have crankcase heaters. Condensing unit control systems are provided wired from the factory. Field Connection is made by connecting supply power to the compressor contactor.

Outdoor condensing unit applications require the use of an optional UL listed hood, delfield P/N CUHOOD, for protection from the elements. Water cooled units are not recommended for outdoor installation.

Interconnecting piping, curbs or other mounting methods and refrigerant are not included. Installation must be made by a qualified refrigeration technician. Piping runs of greater than 100 feet require consultaion with the factory.

		T20C/T24C
		Delfield Model#: T20-T24CU
Refrigerant		404A
Compressor and wiring	Compressor and Capacity	3 HP Compressor 13560 BTUH @ -32°F, 90 amb, 104.4 Cond: 27,500BTUH @ -5°, 90 amb
	Condensing Unit Wiring	208/230V/60Hz/3Ph Max Fuse Size: 35A Max Circuit Ampacity:25.4A
Control System	High Pressure Switch	Set Point: 450 psig, 380 psig re-set
	Low pressure switch	Set Point: 25psig, Range = 15in to 100psig
	Oil Pressure Differential Switch	Sensotronic Oil Pressure Switch
Compressor Reliability	Crankcase Heater	65 watts
Flow Control	Condenser Capacity Control	Head Pressure Control Set at 84°F, 185psig
	Reciever Capacity	46lbs. @ 90% liquid refrigerant fill (31lbs. max refrigerant charge)
	Accumulator	Yes
Optional Outdoor Hood	Delfield Model Number: CUHOOD	
Shipping Weight	Condensing Unit	500 Lbs.
	Outdoor Hood	100 Lbs.

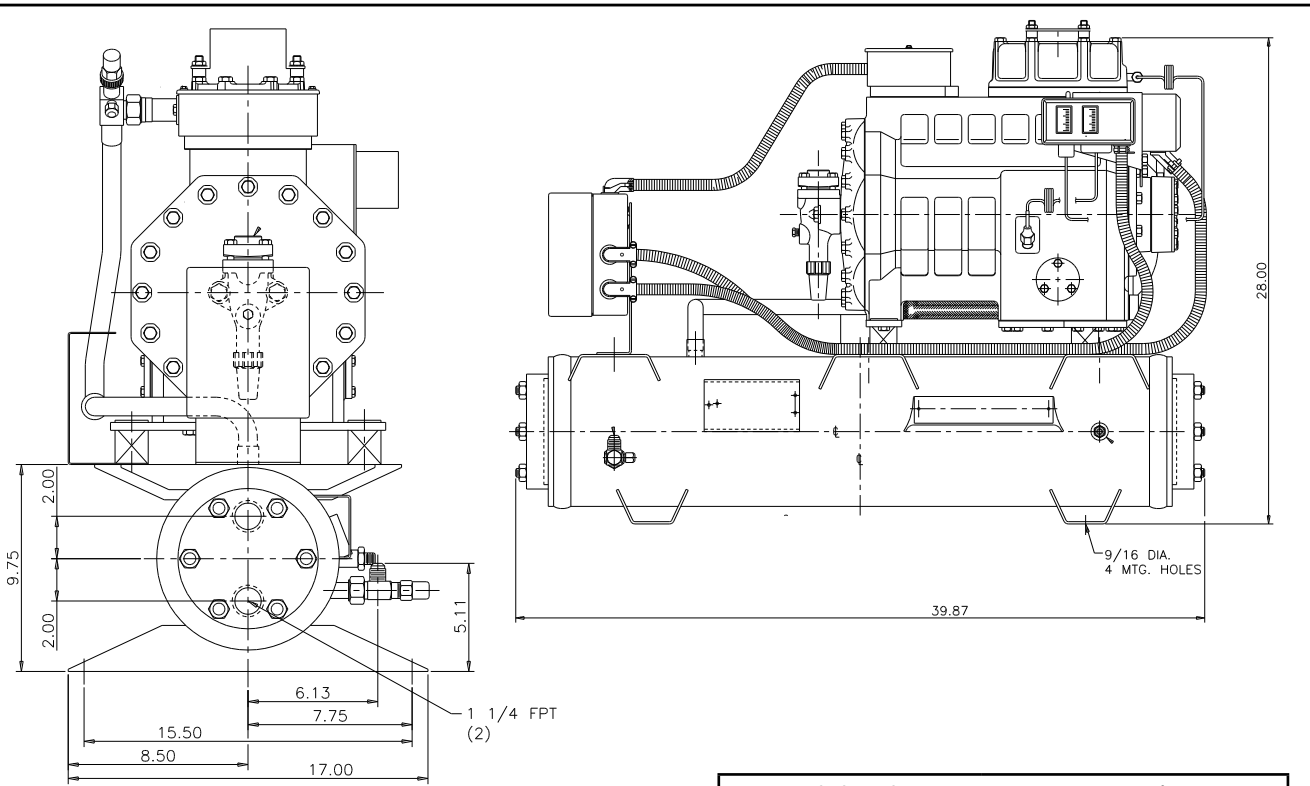

Ambient Operating Limits: 50°F to 110°F

Note: The Delfield Blast Chiller/Shock Freezer is wired independently of the remote condensing unit. No interconnecting wiring is required between the blast chiller and the condensing unit. All condensing units have units have crankcase heaters. Condensing unit control systems are provided wired from the factory. Field Connection is made by connecting supply power to the compressor contactor. Outdoor condensing unit applications require the use of an optional UL listed hood, delfield P/N CUHOOD, for protection from the elements. Water cooled units are not recommended for outdoor installation. Interconnecting piping, curbs or other mounting methods and refrigerant are not included. Installation must be made by a qualified refrigeration technician. Piping runs of greater than 100 feet require consultaion with the factory.

Water cooled condensing unit water usage @ 85°F incoming water, 105°F (250psig) R404a condensing:	
3HP Condensing Unit	
Evaporating Temperature	Condenser Water Usage (GPM)
-40°F	1.8
-30°F	2.5
-20°F	3.2
-10°F	4.0
0°F	4.9

	T20C/T24C	
	Delfield Model#: T20-T24CUW	
Refrigerant		404A
Compressor and wiring	Compressor and Capacity	3 HP Compressor 9,950 BTUH @ -40°F, 85°F inlet water, 105°F Condensing
	Condensing Unit Wiring	208/230V/60Hz/3Ph Max Fuse Size: 35A Man Circuit Ampacity:25.4A
Control System	High Pressure Switch	Set Point: 450 psig, 380 psig re-set
	Low pressure switch	Set Point: 25psig, Range = 15in to 100psig
	Oil Pressure Differential Switch	Sensotronic Oil Pressure Switch
Compressor Reliability	Crankcase Heater	65 watts
Flow Control	Condenser Capacity Control	Head Pressure Control Set at 84°F, 185psig
	Reciever	46lbs. @ 90% liquid refrigerant fill (31lbs. max refrigerant charge)
	Accumulator	Yes
Shipping Weight	Condensing Unit	600 Lbs.

T40: Blast Chiller/Shock Freezer Remote Condensing Unit

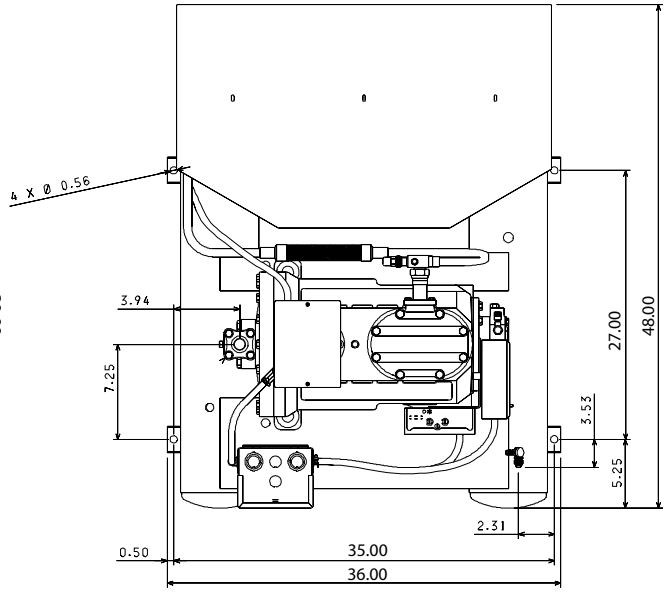
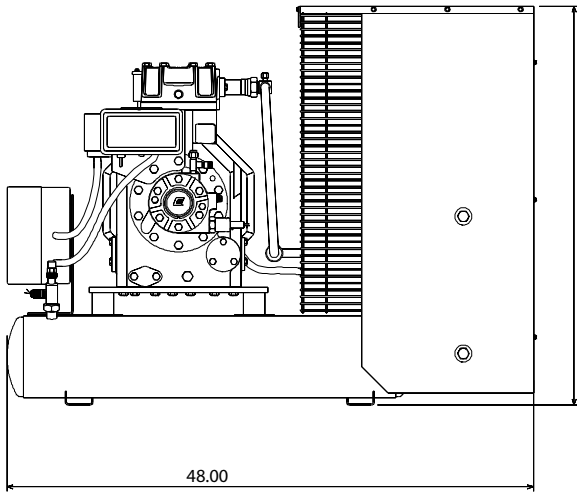

Ambient Operating Limits: -20°F to 120°F

Note: The Delfield Blast Chiller/Shock Freezer is wired independently of the remote condensing unit. No interconnecting wiring is required between the blast chiller and the condensing unit. All condensing units have units have crankcase heaters. Condensing unit control systems are provided wired from the factory. Field Connection is made by connecting supply power to the compressor contactor.

Outdoor condensing unit applications require the use of an optional UL listed hood, delfield P/N CUHOOD, for protection from the elements. Water cooled units are not recommended for outdoor installation.

Interconnecting piping, curbs or other mounting methods and refrigerant are not included. Installation must be made by a qualified refrigeration technician. Piping runs of greater than 100 feet require consultaion with the factory.

	T40	
	Delfield Model#: T40CU	
Refrigerant		404A
Compressor and wiring	Compressor and Capacity	6 HP Compressor 24,150 BTUH @ -32°F, 90 amb, 102.2 Cond: 46,740BTUH @ -5°, 90 amb110.3 Cond.
	Condensing Unit Wiring	208/230V/60Hz/3Ph Max Fuse Size: 60A Max Circuit Ampacity:42.3A
Control System	High Pressure Switch	Set Point: 450 psig, 380 psig re-set
	Low pressure switch	Set Point: 25psig, Range = 15in to 100psig
	Oil Pressure Differential Switch	Sensotronic Oil Pressure Switch
Compressor Reliability	Crankcase Heater	65 watts
Flow Control	Condenser Capacity Control	Head Pressure Control Set at 84°F, 185psig
	Reciever Capacity	55.4lbs. @ 90% liquid refrigerant fill (37.5lbs. max refrigerant charge)
	Accumulator	500 Cubic Inch Capacity
	Oil Separator	Yes
	Oil Filter	Yes
Optional Outdoor Hood	Delfield Model Number: CUHOOD	
Shipping Weight	Condensing Unit	600 Lbs.
	Outdoor Hood	100 Lbs.

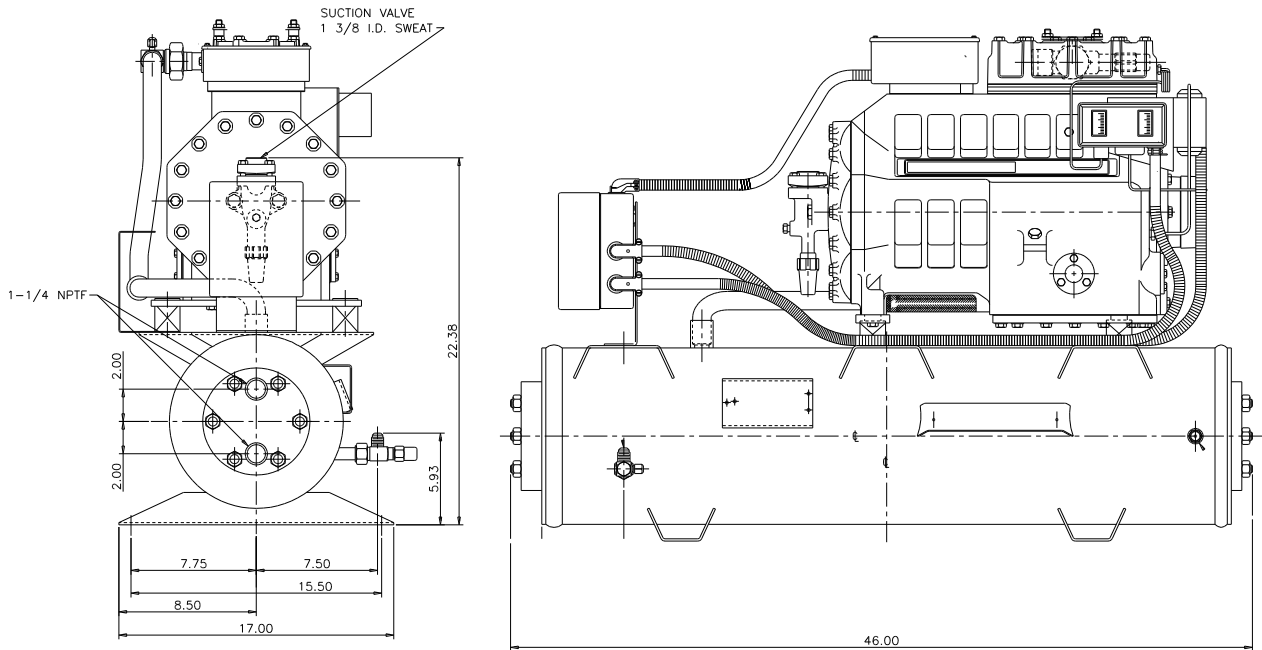

Ambient Operating Limits: 50°F to 110°F

Note: The Delfield Blast Chiller/Shock Freezer is wired independently of the remote condensing unit. No interconnecting wiring is required between the blast chiller and the condensing unit. All condensing units have crankcase heaters. Condensing unit control systems are provided wired from the factory. Field Connection is made by connecting supply power to the compressor contactor.

Outdoor condensing unit applications require the use of an optional UL listed hood, delfield P/N CUHOOD, for protection from the elements. Water cooled units are not recommended for outdoor installation. Interconnecting piping, curbs or other mounting methods and refrigerant are not included. Installation must be made by a qualified refrigeration technician. Piping runs of greater than 100 feet require consultation with the factory.

Water cooled condensing unit water usage @ 85°F incoming water, 105°F (250psig) R404a condensing:

6HP Condensing Unit	
Evaporating Temperature	Condenser Water Usage (GPM)
-40°F	3.15
-30°F	4.1
-20°F	5.2
-10°F	6.4
0°F	7.8

	T40	
	Delfield Model#: T40CUW	
Refrigerant		404A
Compressor and wiring	Compressor and Capacity	6 HP Compressor 24,950 BTUH 4.1gpm waterflow @ -32°F, 90 amb, 102.2 Cond: 18,090 BTUH @-40°F, 85°F inlet water, 105°F Condensing
	Condensing Unit Wiring	208/230V/60Hz/3Ph Max Fuse Size: 60A Max Circuit Ampacity:42.3A
Control System	High Pressure Switch	Set Point: 450 psig, 380 psig re-set
	Low pressure switch	Set Point: 25psig, Range = 15in to 100psig
	Oil Pressure Differential Switch	Sensotronic Oil Pressure Switch
Compressor Reliability	Crankcase Heater	65 watts
Flow Control	Condenser Capacity Control	Head Pressure Control Set at 84°F, 185psig
	Receiver Capacity	55.4lbs. @ 90% liquid refrigerant fill (37.5lbs. max refrigerant charge)
	Accumulator	500 Cubic Inch Capacity
	Oil Separator	Yes
	Oil Filter	Yes
Optional Outdoor Hood	Delfield Model Number: CUHOOD	
Shipping Weight	Condensing Unit	600 Lbs.
	Outdoor Hood	100 Lbs.

T5/T14D REFRIGERATION SYSTEM SCHEMATIC

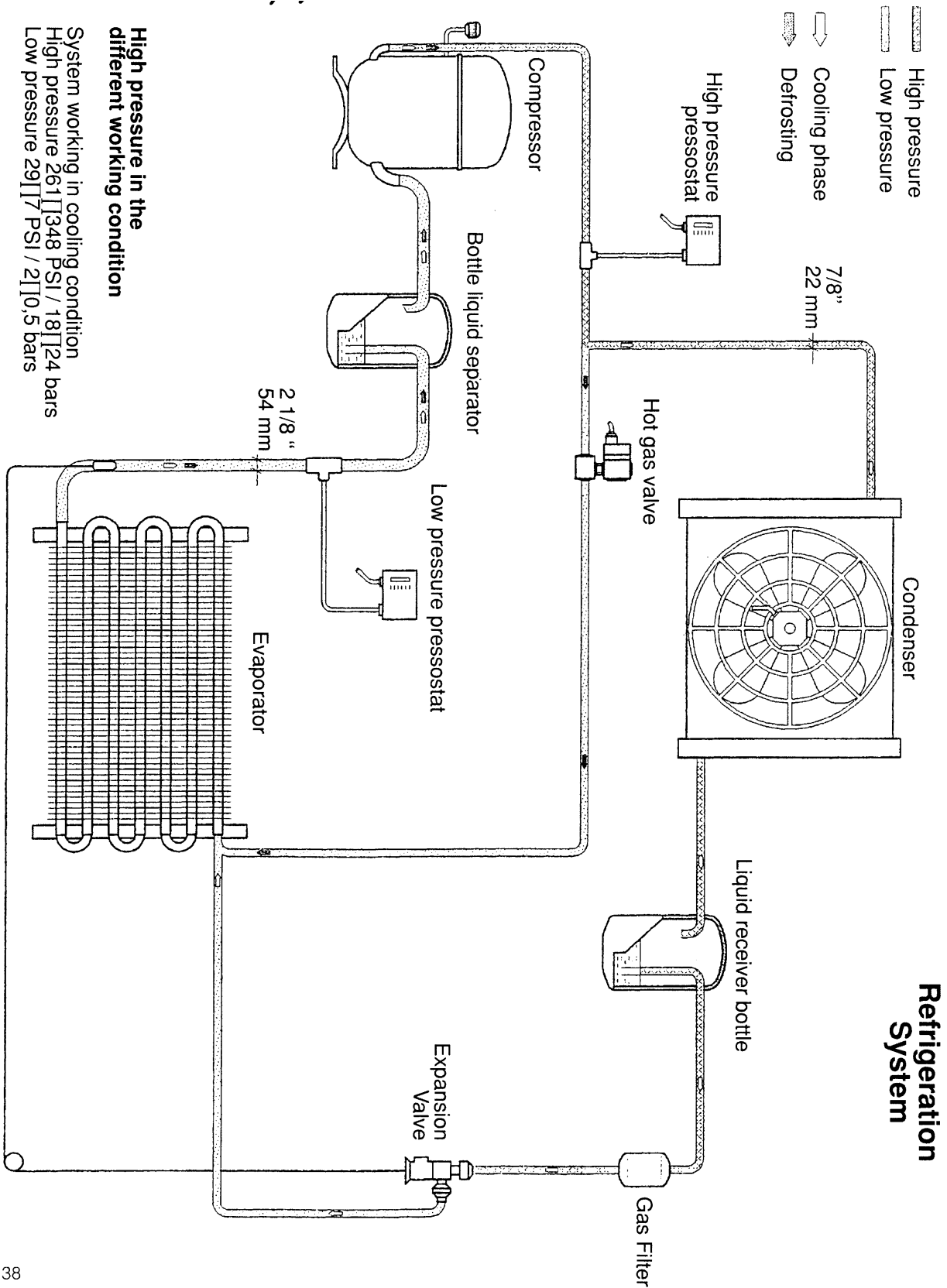

9. WIRING DIAGRAMS

A TERMINI DI LEGGE LA "CASTELMAC" SI RISERVA LA PROPRIETA' ESCLUSIVA DEL PRESENTE DISEGNO CHE NON DEVE ESSERE RIPRODOTTO O TRASMESSO A TERZI SENZA AUTORIZZAZIONE

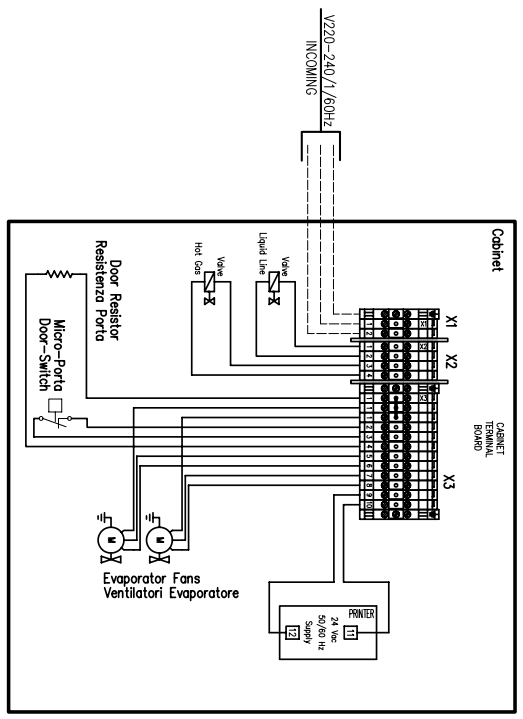
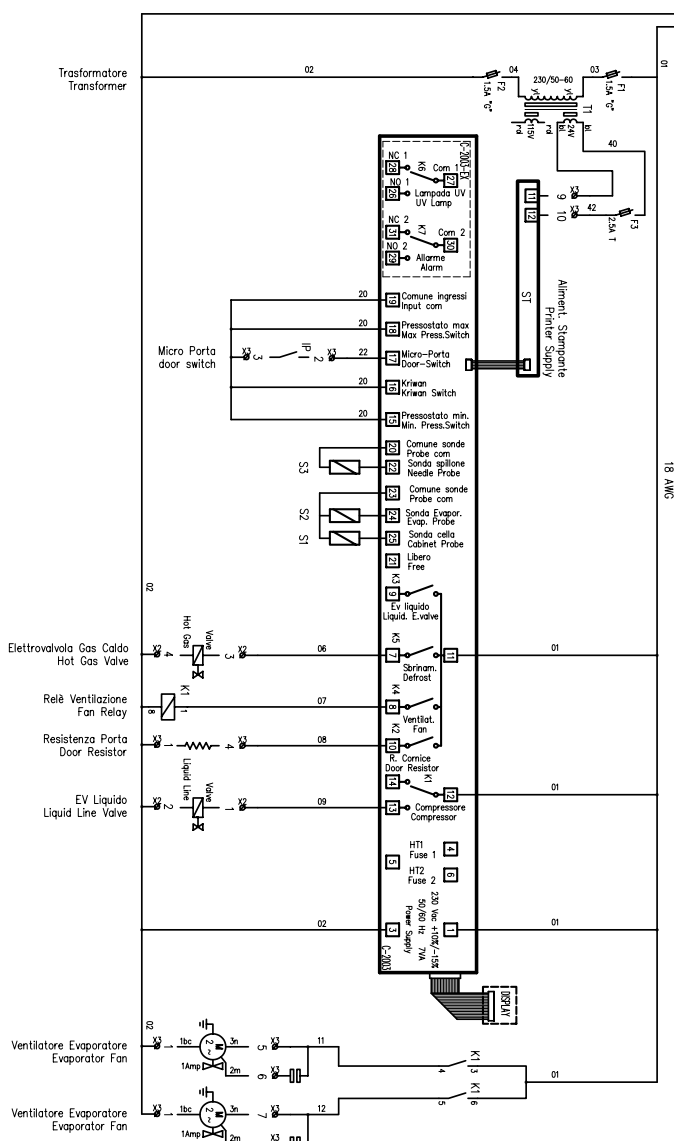

Note per fornitore:
Realizzare il quadro con quattro in metallo e componistica omologata UL-CSA (venti - pressostati - rele - ecc)

Code	Alimentazione	In
Quadro pot.		
XXXXXXXXXX/D	V230/60Hz	6A

INDI. DATA	MODIFICHE	DIS. VERIF. DOMINIC
quatre senza indicazione di tolleranza * graduo di ALBERI TOLLERANZA *		
MATERIALE		GRADO DI LAVORAZ
N. PEZZI	TRATT. SUPERFICIALE	TRATT. TERMICI
DATA 04-06-07		
DIS. GRAFICI	ABBATTITORE T24-UL	
VERIF. FARELLI	SCHEMA ELETTRICI - WIRING DIAGRAM	
CASTELMAC	Alimentazione 230/60	
Castelfranco Vio		
		SCALA
		1/2 3/4 5/6 7/8 9
		CODICE N°
		71510401/10

A TERMINI DI LEGGE LA "CASTELMAC" SI RISERVA LA PROPRIETA' ESCLUSIVA DEL PRESENTE DISEGNO CHE NON DEVE ESSERE RIPRODOTTO O TRASMESSO A TERZI SENZA AUTORIZZAZIONE

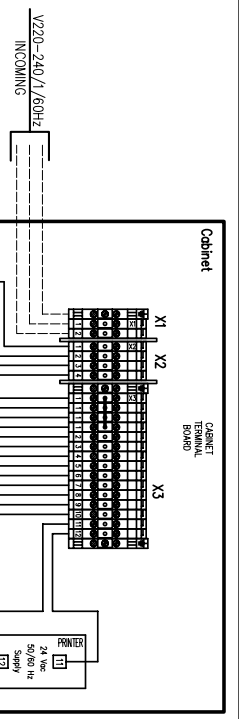
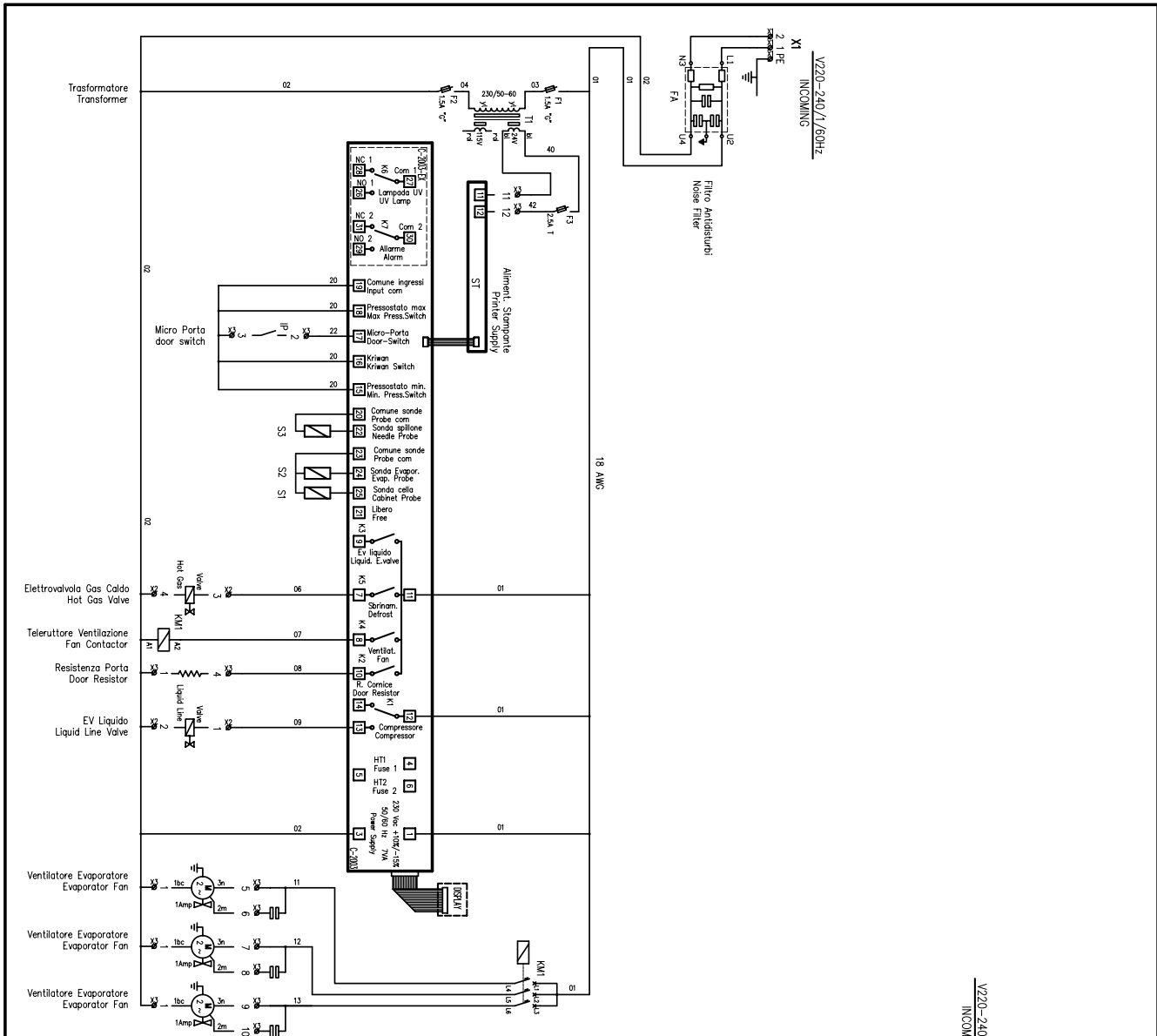

Note per fornitore:
 Realizzare il quadro con quattro in metallo e componistica omologata U.L. (SA) (cavi - pressaviti - rite - ecc)

Codice Quadro pot.	Alimentazione	In
XXXXXXXXXX/1	V230/60Hz	6A

INDI	DATA	MODIFICHE	DIST. VERIF. EDIFICAZIONE
DATA	04-06-07	TRATTI SUPERFICIALE	TRATTI TERMICI
DIS.	gravedi	ABBATTITORE T20R-C+ UL	SCALA
VERIFI.	FIRELLI	SCHEMA ELETTRICI - VIRING DIAGRAM	1 2 3 4 5 6 7 8 9
CASTELMAC	Castelfranco Vio	Alimentazione 230/60	CODICE N° 71510402/0

A TERMINI DI LEGGE LA "CASTELMAC" SI RISERVA LA PROPRIETA' ESCLUSIVA DEL PRESENTE DISEGNO CHE NON DEVE ESSERE RIPRODOTTO O TRASMESSO A TERZI SENZA AUTORIZZAZIONE

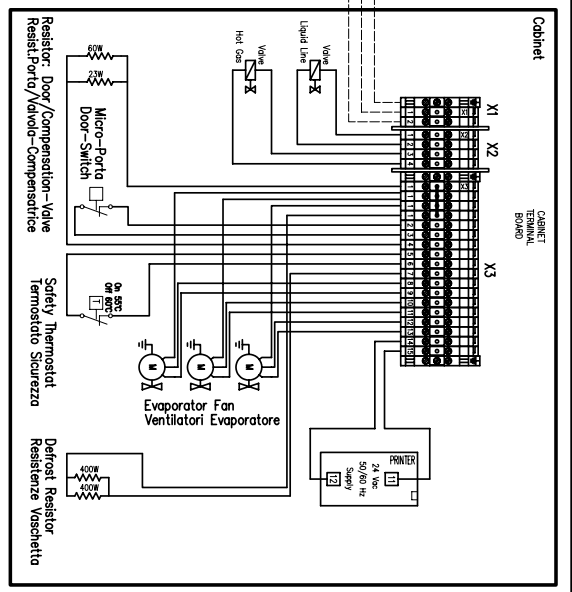
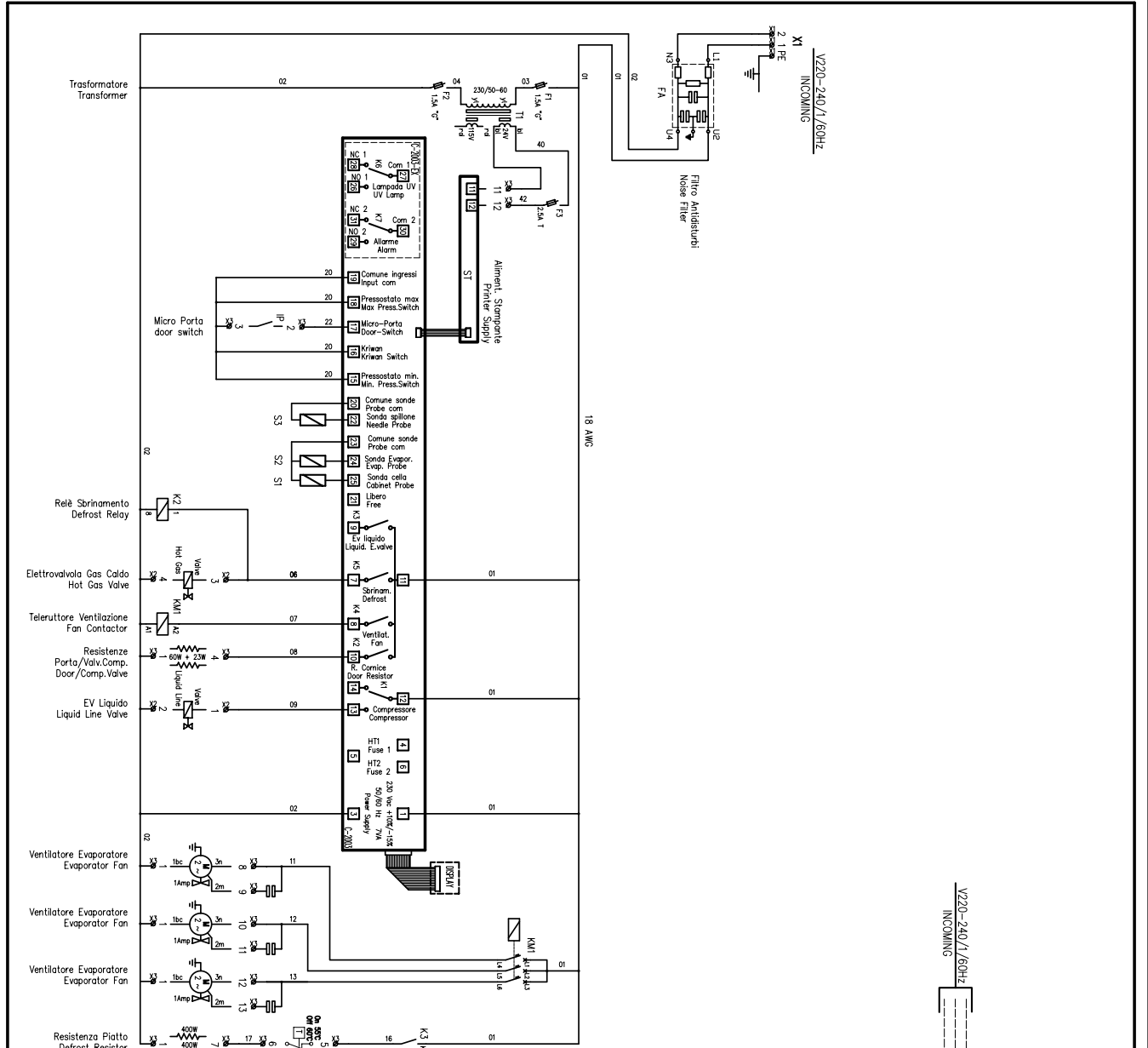

MODIFICHE		DTS. VERIF. EDIMING	
NOTE SENZA INDICAZIONE DI TOLLERANZA GRADO DI PRESSIONE VERBA. UNI ISO 2768 M		5207 CT	
MATERIALE		GRADO DI LAVORAZ	
N. PEZZI	TRATT. SUPERFICIALE	TRATT. TERMICI	PESCI
DATA 04-06-07			
DIS. GARDI	TRAFF. 230/60	UL-CSA	SCALA
VERIF. FORTELLI	SCHEMA ELETTRICO - VIRING DIAGRAM		1 2 3 4 5 6 7 8 9
CASTELMAC	ASS. DITTAZIONE		CODICE N°
Castelfranco Vio			71510403.0

Note per fornitore:
Realizzare il quadro con i materiali e componenti omologati UL e CSA (cavi - pressostati - rele - ecc)

Codice Quadro pot.	Alimentazione	In
XXXXXXXXXX/1	V230/60Hz	6A

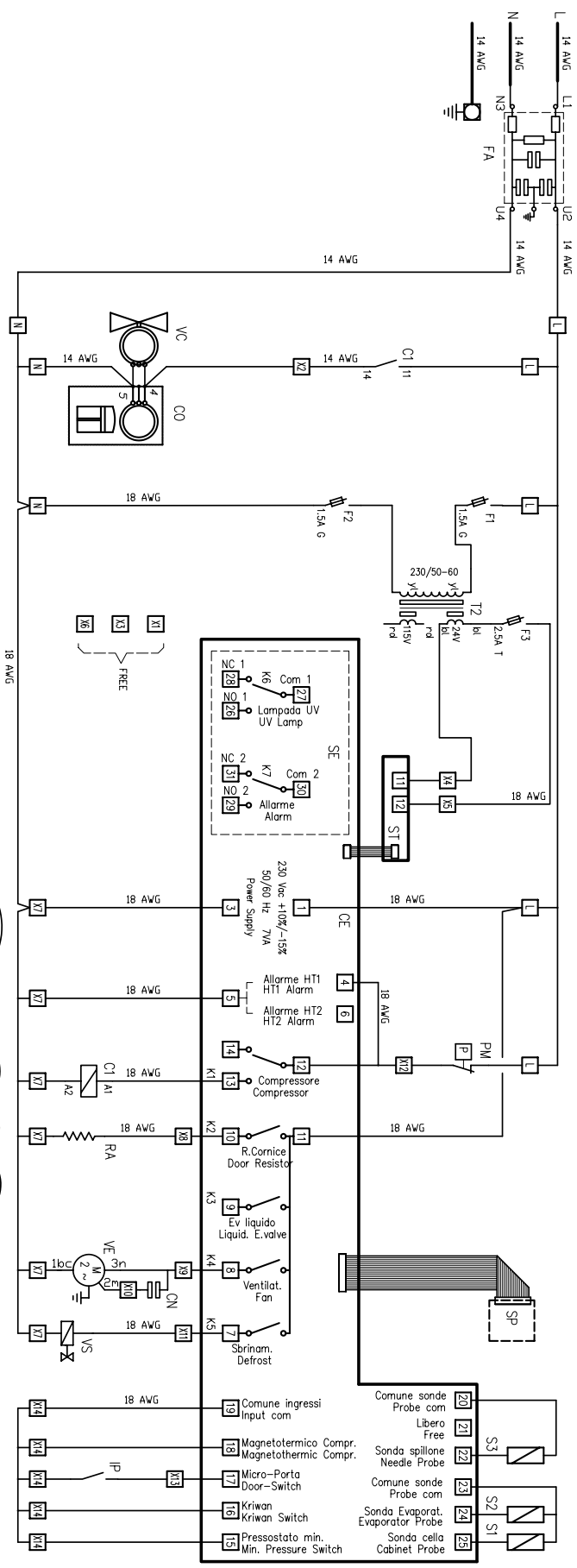

Italiano	English	Español
CE	Central Card	Central Electronica
SP	Scheda Pulsanti/Display	Display Electronic Card
SE	Scheda Espansione	Expansion Electronic Card
ST	Stampante	Stampante
C1	Relè Compressore	Relé del Compresor
CO	Compressore	Compresor
VC	Ventilatore Condensatore	Ventilador del Condensador
CN	Condensatore Ventilatori	Condensador de los Ventiladores
RA	Resistenza Cornice	Resistencia de la Puerta
VS	Elettrovalvola Gas-Caldo	Electrovalvula de Descongelacion
T2	Trasformatore	Transformador
F1 F2 F3	Fusibili	Fusible
PM	Pressostato di Massima	Presostato de Máximo
IP	Interruttore Porta	Interruptor de la Puerta
FA	Filtro Antidisturbi	Filtro Electronico
S1	Sonda Camera	Sonda del aire la Cámara
S2	Sonda Evaporatore	Sonda del evaporador
S3	Sonda Spillore/Agg	Sonda de Aguja/Aguja

SEZIONE CAVI / CABLES SECTION / SECCION DE LOS CABLES

0.83 mmq 18 AWG
 2.8 mmq 14 AWG

COLORI CAVI / CABLES COLORS / COLORES DE LOS CABLES

m	Marrone	Brown	Marrón
n	Nero	Black	Negro
bc	Blu Chiaro	Light Blue	Azul Claro
bi	Bianco	White	Bianco
qv	Giallo/Verde	Yellow/Green	Amarillo/Verde

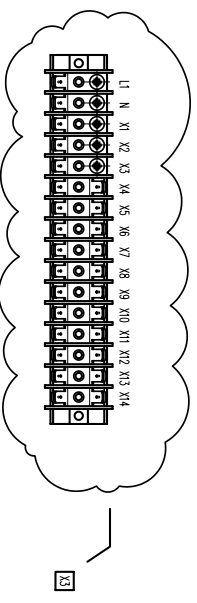

2	04-05-2007	UV lamp and door switch relay and F4 fuse, have been removed	
1	07-05-2007	Add door switch relay	
DATE		01-08-06	
DelField			
U.S.A.			
		BLAST CHILLER T5	
		ELECTRIC DIAGRAM	
		220V/60Hz	
			CODE
			71510408/0

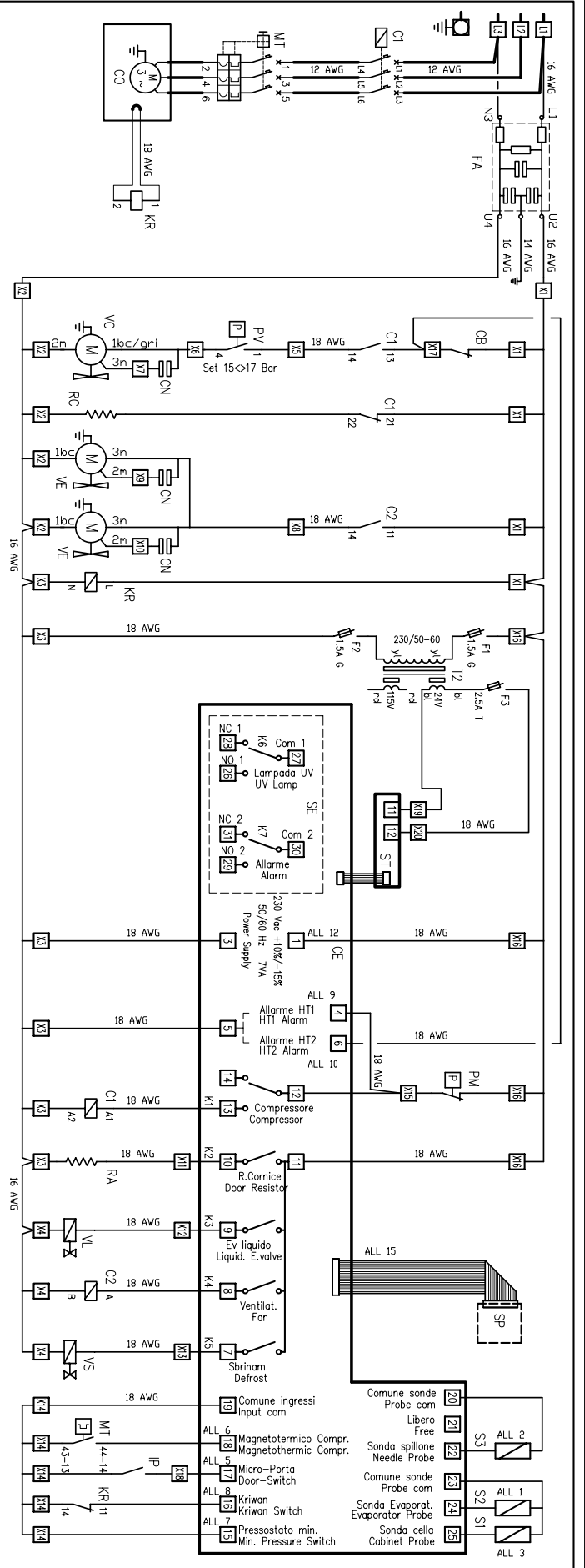

Italiano	English	Español
PV	Pressostato Ventilatore	Fan Pressure Switch
CB	Protezione Termica Ventilat.	Circuit Breaker
CE	Centralina Elettronica	Electronic Card
SP	Scheda Pulsanti/Display	Display Electronic Card
SE	Scheda Espansione	Expansion Electronic Card
ST	Stampante	Printer
C1	Teleportatore Compressore	Compressor Relay
C2	Relè Ventilazione	Fan Relay
MT	Magnetotermico	Magnetothermal Switch
CO	Compressore	Compressor
VC	Ventilatore Condensatore	Condensator Fan
CN	Condensatore Ventilatori	Fan Capacitor
RC	Resistenza Compressore	Heater Compressor Resistor
KR	Kriwan	Kriwan
RA	Resistenza Corrice	Door Resistor
VL	Elettrovalvola liquido	Liquid Electric Valve
VS	Elettrovalvola Gas-Caldo	Defrost Electric Valve
T2	Trasformatore	Transformer
F1/F13	Fusibili	Fuses
PM	Pressostato di Massima	Max Pressure Switch
IP	Interruttore Porta	Door Switch
FA	Filtro Antidisturbi	Noise Filter
S1	Sonda Camera	Cabinet Probe
S2	Sonda Evaporatore	Evaporator Probe
S3	Sonda Spillore/Ago	Needle Probe

SEZIONE CAVI / CABLES SECTION / SECCION DE LOS CABLES	0,83 mmq / 12 AWG
3,31 mmq / 18 AWG	
COLORI CAVI / CABLES COLORS / COLORES DE LOS CABLES	
m	Marrone
n	Nero
bc	Blu Chiaro
bi	Bianco
gv	Giallo/Verde

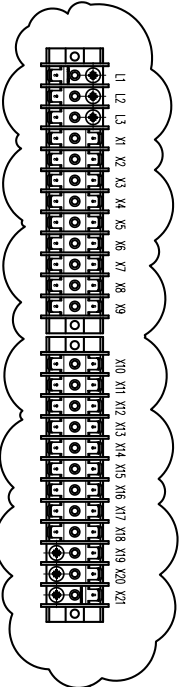

3	04-06-2007	UV lamp and door switch relay and F4 fuse have been removed
2	07-05-2007	Add door switch relay
1	07-05-2007	CB moved
BLAST CHILLER 714D		
ELECTRIC DIAGRAM		
DATE	01-08-06	
DelField		
	220V/3/50Hz	
CODICE		71510409/0

T40 Installation and Assembly

Supplied Equipment List.

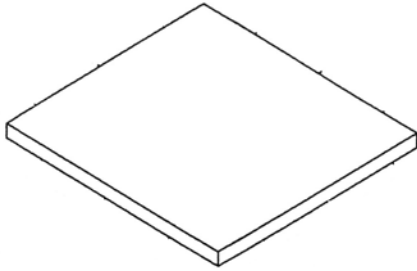

T40 Base

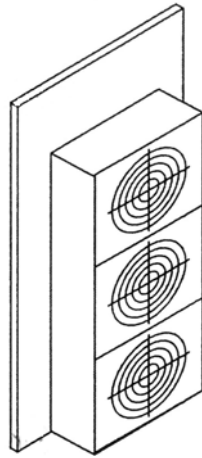

T40 LS Wall Panel

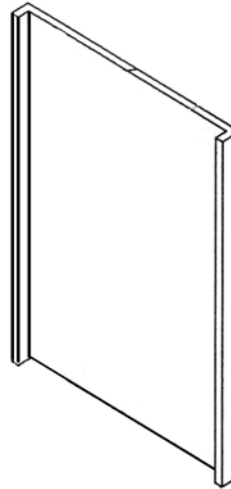

T40 Back Panel

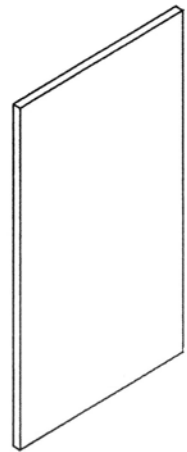

T40 RS Wall Panel



T40 Control Box

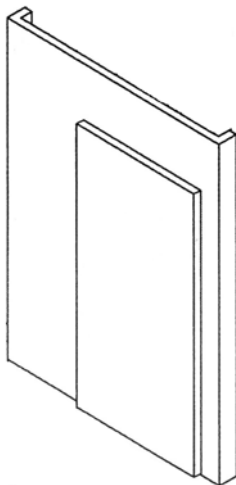

T40 Front Panel
with Door

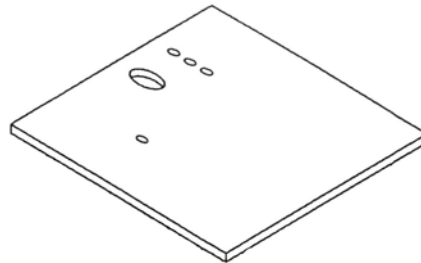

T40 Top Panel

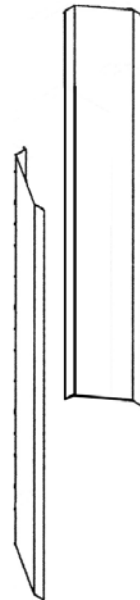

T40 Air Deflection
Shields

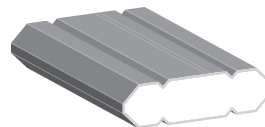

Alignment Blocks

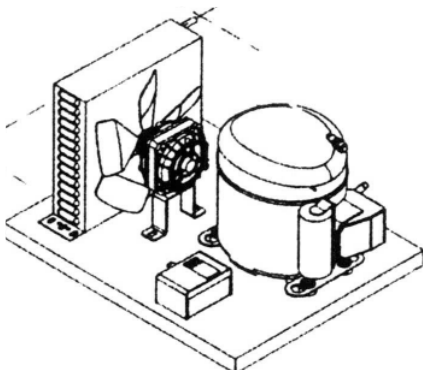

T40 Remote Condensing Unit



Cam Lock T-Handle



Cam Hole Covers

T40 Installation and Assembly

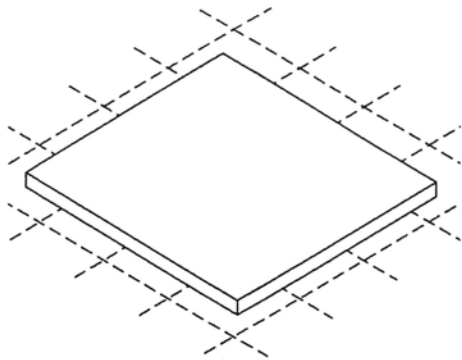
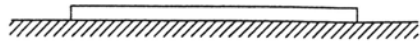

1. Position cabinet floor on a flat, level surface with the slotted end facing up.



- Ensure the entryway is facing forward (gray plastic transition piece)
- Insert one alignment block into the channel in between each of the locking cams.

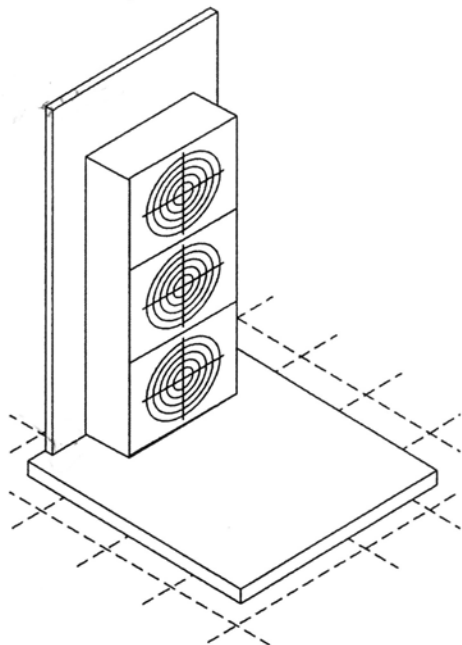

2. Raise the first panel (with the evaporator, fans and air channel) onto the mounting floor with the fans facing inside.

- Place bottom of the panel into the alignment channel on the mounting floor for proper placement, using the alignment block to align panel.

NOTE: Do not break alignment block when placing panels in place.

The first panel will be the left side of the unit if you are facing the door.

NOTE: Ensure all cam locks are in the open position before placing any panels.



Make sure the skirt on the vertical panels covers the outside of the mounting floor.

Lock bottom locking cams on the outside of the first panel. Insert T-handle wrench and twist clockwise until a positive stop is achieved.



The panel will now stand on its own.

NOTE: Do not lean or push on unsupported panels.



3. Attach the back panel to the mounting floor in the same manner as the first panel. The back panel will wrap around both sides.

NOTE: Ensure all cam locks are in the open position before placing any panels.

NOTE: Do not break alignment block when placing panels in place.

Lock the side locking cams on the outside of the first panel and the left side and bottom locking cams on the inside of the back panel. Insert T-handle wrench and twist clockwise until a positive stop is achieved.

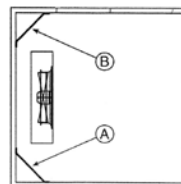

- Attach deflector shields either side of the first panel as shown. The deflector shields will cover the corners on the first panel and are attached with provided screws.

T40 Installation and Assembly



4. Attach the right side panel to the mounting floor in the same manner as the other two panels. Lock the side locking cams on the inside bottom and side of the panel. Insert T-handle wrench and twist clockwise until a positive stop is achieved.

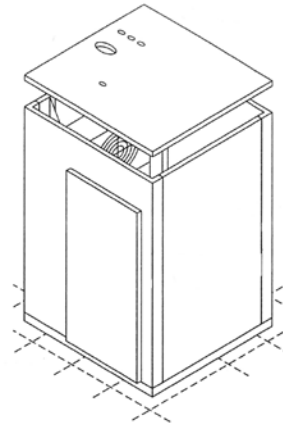

NOTE: Ensure all cam locks are in the open position before placing any panels.

NOTE: Do not break alignment block when placing panels in place.

6. Place the top panel on to the top of the cabinet with the refrigeration holes facing the first panel. Tread the refrigeration pipes through the supplied holes and ensure there is no binding.



NOTE: Ensure all cam locks are in the open position before placing any panels.

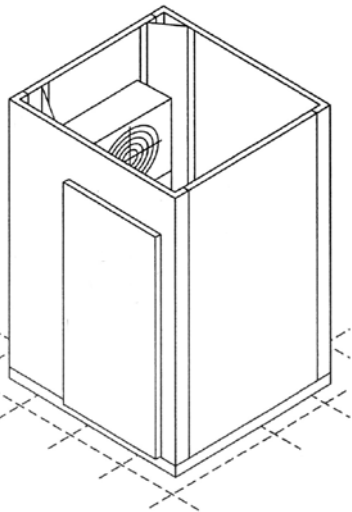

5. Attach the front panel in the same manner as the others. Front panel will wrap around the sides. Lock all side and bottom cams when the panel is in position. Insert T-handle wrench and twist clockwise until a positive stop is achieved.



Lock all side cams when the panel is in position. Insert T-handle wrench and twist clockwise until a positive stop is achieved.

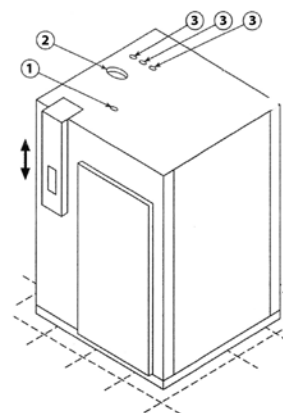
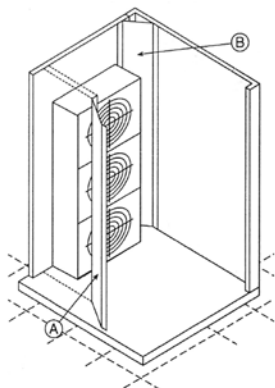

- 1. Hole for Probes
- 2. Electrical Hole
- 3. Refrigerant Line Holes



• Attach the Left side deflector shield to the front panel with provided screws. The shield should cover the corner.

7. Place the control panel on the outside of the top and front of the unit. Attach with supplied screws and screw holes.

T40 Installation and Assembly



This should be done by a qualified refrigeration expert.

Put the compressor system in a suitable, well aired place no farther than 25 feet. from cabinet.

11. Place interior probes

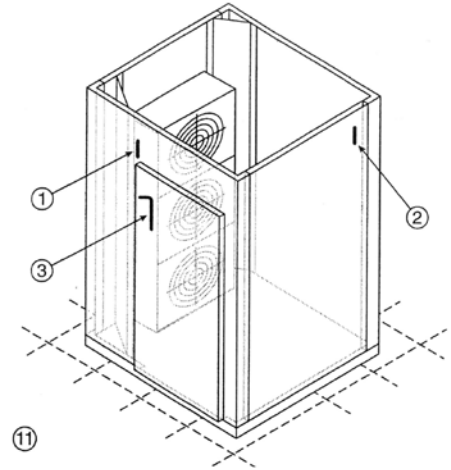

8. Thread electrical from the inside of the unit through the supplied hole in the top. Do not cut another hole to thread electrical.

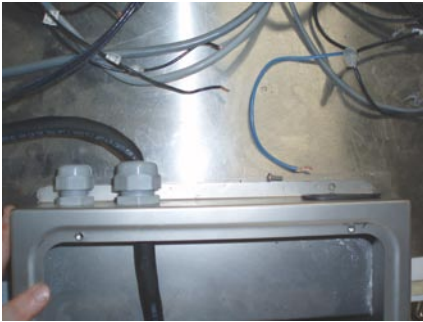

1. Interior Probe1: Place on wall next to the evaporator
2. Food Probe: Place in food product for monitoring
3. Interior Probe2: Place on opposite side of cabinet from evaporator 3/4 of the way to the top of the cabinet.

9. Thread electrical wires through the top of control box and connect to controls.

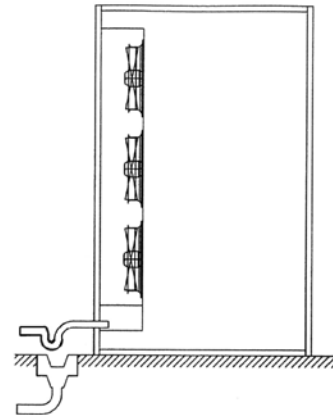
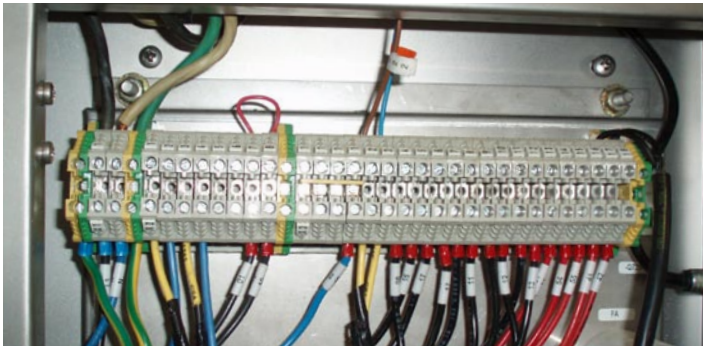

• Attach labeled electrical line to the corresponding labeled connector on the control panel.

10. Pipe remote condensing unit to the refrigerant lines coming out of the top of the cabinet.

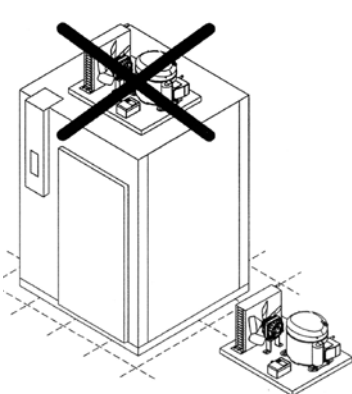

12. Unit must be plumbed with a P-trap to a drain for evaporator water discharge.

13. Place cam plugs in all cam holes to cover them. Press until seated in holes.

14. Install ramp and threshold onto the front of the outside of the door.



Mt. Pleasant, MI



Covington, TN

Thank you for choosing Delfield!

Help is a phone call away. Help our team of professional, courteous customer service reps by having your model number and serial number available at the time of your call (800) 733-8829.

Model: _____ S/N: _____

Installation Date: _____



**For a list of Delfield's authorized parts depots,
visit our website at www.delfield.com.**



980 S. Isabella Rd., Mt. Pleasant, MI 48858, U.S.A. • (989) 773-7981 or (800) 733-8829 • Fax (888) 779-2040 • www.delfield.com
Delfield reserves the right to make changes in design or specifications without prior notice. ©2007 The Delfield Company. All rights reserved. Printed in the U.S.A.

DMCONVOCHILL 06/07

Free Manuals Download Website

<http://myh66.com>

<http://usermanuals.us>

<http://www.somanuals.com>

<http://www.4manuals.cc>

<http://www.manual-lib.com>

<http://www.404manual.com>

<http://www.luxmanual.com>

<http://aubethermostatmanual.com>

Golf course search by state

<http://golfingnear.com>

Email search by domain

<http://emailbydomain.com>

Auto manuals search

<http://auto.somanuals.com>

TV manuals search

<http://tv.somanuals.com>