



PAC70 ECO

- Istruzioni per l'usopag. 4
- Use and maintenance manualpag. 22
- Mode d'emploi et d'entretienpag. 40
- Betriebsanleitungpag. 58
- Gebruiksaanwijzingpag. 76
- Instrucciones de usopag. 94
- Manual de instruçõespag. 112

DeLonghi

Gentile Cliente,
La ringraziamo per aver scelto un prodotto De'Longhi, il leader mondiale nella costruzione dei climatizzatori portatili. Anni di esperienza in tutto il mondo ci consentono di migliorare costantemente la qualità e le prestazioni di Pinguino e SuperPinguino. Siamo certi che rimarrà subito soddisfatto del suo acquisto e che godrà a lungo del fresco benessere che Pinguino e SuperPinguino creano. La preghiamo di dedicare un po' del suo tempo alla lettura di questo libretto di istruzioni, e di conservarlo con cura. In questo modo, potrà utilizzare Pinguino nelle condizioni di massima efficacia e serenità.

Dear Customer,
Thank you for having purchased an appliance made by De' Longhi, the international leader in portable air conditioning units. Thanks to our years of experience all around the world we are constantly improving the quality and performance of Pinguino. We are confident that you will be satisfied with your purchase and enjoy the cool comfort created by the Pinguino for many years to come. You should spend some time reading this instruction manual and keep it handy to refer to in order to use your Pinguino efficiently.

Chère Cliente, Cher Client,
Nous vous remercions d'avoir choisi un produit De'Longhi, le plus important fabricant mondial de climatiseurs portables. Des années d'expérience dans le monde entier nous permettent d'améliorer constamment la qualité et les performances de Pinguino. Nous sommes certains que vous serez immédiatement satisfait de votre achat et que vous profiterez pendant longtemps de la fraîcheur et du bien-être que Pinguino crée. Nous vous prions de bien vouloir consacrer un peu de temps à la lecture de ce mode d'emploi et de le conserver soigneusement. Ses conseils vous permettront d'obtenir les meilleurs résultats de votre Pinguino en toute sécurité.

Verehrter Kunde
Wir danken Ihnen, daß Sie sich für ein Produkt von De'Longhi entschieden haben, dem weltweiten Marktführer bei der Herstellung von tragbaren Klimageräten. Jahre der Erfahrung in der gesamten Welt ermöglichen uns, die Qualität von Pinguino und SuperPinguino konstant zu verbessern. Wir sind sicher, daß Sie mit Ihrem Kauf zufrieden sein werden und das frische Wohlbefinden, das Pinguino und SuperPinguino verbreiten, über eine lange Zeit genießen werden. Wir bitten Sie, sich etwas Zeit zu nehmen, um diese Gebrauchsanweisung durchzulesen und Sie danach sorgfältig aufzubewahren. Auf diese Weise haben Sie die Gewißheit, mit Pinguino die größte Leistungsfähigkeit und Sicherheit zu erzielen.

Geachte Client,
Wij danken u voor het kiezen van een produkt De'Longhi, nummer één op wereldniveau op het gebied van de constructie van draagbare airconditioners. Jaren ervaring over de hele wereld maken het ons mogelijk de kwaliteit en de prestaties van Pinguino en SuperPinguino constant te verbeteren. Wij zijn er zeker van dat u tevreden zult zijn met uw aankoop en dat u voor lange tijd zult genieten van het frisse welzijn dat Pinguino en Superpinguino in staat zijn te creëren. Wij verzoeken u enige tijd te besteden aan het lezen van dit instructieboekje, en dit goed te bewaren. Op deze manier zult u Pinguino kunnen gebruiken met de meeste efficiëntie en zonder problemen.

Estimado Cliente
Le agradecemos por haber elegido un producto De' Longhi, líder mundial en la fabricación de los acondicionadores portátiles. Años de experiencia en todo el mundo nos permiten mejorar constantemente la calidad y las prestaciones de Pinguino. Estamos seguros que quedará inmediatamente satisfecho de su compra y que gozará por largo tiempo el fresco bienestar que da Pinguino. Le pedimos que dedique un poco de su tiempo a la lectura de este manual de instrucciones y de guardarlo con cuidado. De este modo, podrá usar Pinguino en condiciones de máxima eficacia y serenidad.

Prezado Cliente
agradecemos por ter escolhido um produto Dé Longhi, o líder mundial na fabricação dos condicionadores portáteis. Anos de experiência em todo o mundo permitem-nos melhorar constantemente a qualidade e os desempenhos dos aparelhos Pinguino. Temos certeza de que ficará logo satisfeito com a sua compra e que usufruirá por muito tempo do fresco bem-estar que Pinguino e Super Pinguino oferecem. Por favor, dedique um pouco do seu tempo à leitura deste manual de instruções e conserve-o com cuidado. Desta forma, poderá utilizar o aparelho Pinguino com a máxima eficácia e serenidade.

Descrizione • Description • Description • Beschreibung •
Beschrijving • Descriptción • Descrição

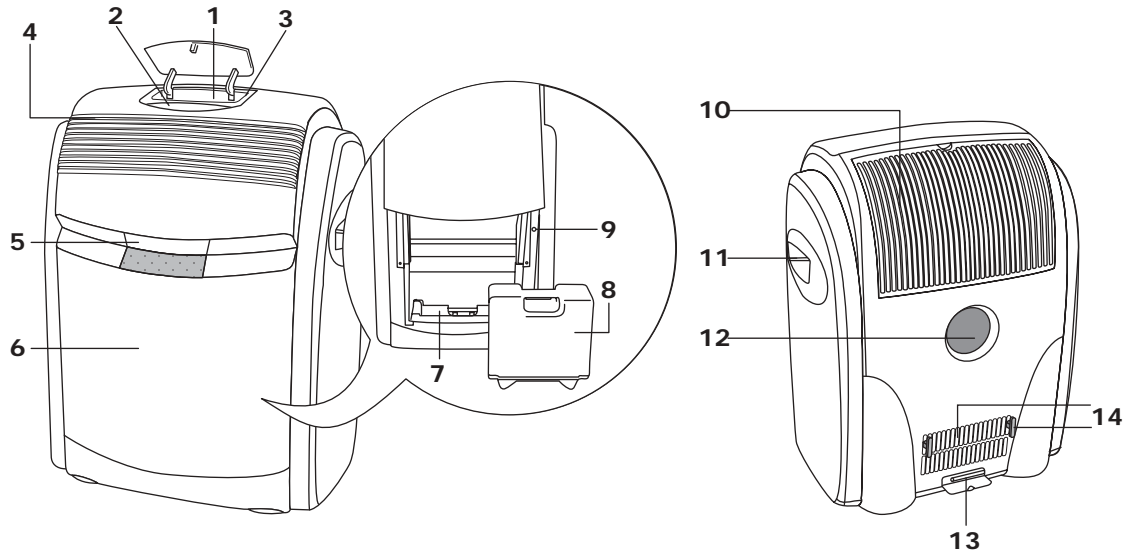

ACCESSORI • ACCESSORY-SET • ACCESSOIRES • ZUBEHÖR • ACCESSOIRES • ACCESORIOS
• ACESSÓRIOS

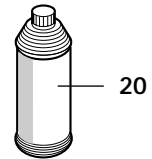
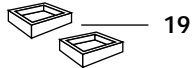
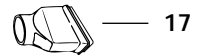
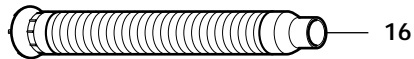

Important safeguards

- Use this appliance only as described in this instruction manual.
As with any electrical appliance, whilst the instructions aim to cover as many eventualities as possible caution and common sense should be applied when operating and installing this air conditioner.
- This appliance has been manufactured to cool and de-humidify domestic environments and should not be used for other purposes.
- It is dangerous to alter or modify the unit's characteristics in any way.
- The appliance must be installed in line with the relevant national legislation.
- Should repairs be necessary, contact the nearest authorised Repair Service Centre. Unauthorised servicing can be dangerous.
- This appliance is to be used by adults only; keep away from children.
- In the case that the power cable becomes damaged, this must be substituted only by specialised personnel authorised by the manufacturer.
- Always ensure the appliance is earthed. If you have any doubts check with a qualified electrician.
- Avoid using extension leads with the unit.
- Before cleaning or maintenance operations, always unplug the unit from the socket.
- Do not pull on or place strain on the power cable when moving the appliance.
- The appliance should not be installed where the atmosphere may contain combustible gases, oil or sulphur, or near heat sources.
- If the appliance is utilised in areas where there is no ventilation of air, it is necessary to take precautions to avoid that the refrigerant gases that may leak from the appliance do not remain in the room, thereby causing a fire hazard.
- This appliance must be utilised and installed only in rooms with a total volume of 15 cubic metres or greater.
- The refrigerant gases R290 conform to EC regulations on the environment. Avoid perforating the refrigerant circuit of the appliance.
- Keep the unit at least 50 cm away from inflammable substances (alcohol etc) or pressurised containers (eg. aerosol cans).
- Do not rest hot or heavy objects onto the appliance.
- Clean the dust filter at least once a week.
- Remember to perform the descaling procedure at the end of each season (see page 37). In areas where the water is particularly hard (rich in minerals), the use of a commercial anti-lime product added to the water is recommended. This can be requested from De'Longhi LTD.
- Avoid using heaters near the unit.
- Do not cover this appliance with bags when is not in use
- Unventilated area where the appliance using flammable refrigerants is installed shall be so constructed that any leaked refrigerants will not stagnate so as to cause a fire or an explosion hazard caused by igniting stagnant refrigerants from other source such as electric heater, stove and similar home applications.
- The unit should be transported in a vertical position. If this is not possible secure the unit at an angle, do not lie horizontally.
Before transporting the unit drain the condensation collecting-tray and tank. After transportation, wait at least 1 hour before switching on the unit.
- The packaging materials can be recycled. You are therefore recommended to place them in the special containers for differentiated waste collection.

How does your Pinguino work

During the summer, optimum comfort is achieved with a temperature of between 24 and 27°C and about 50% relative humidity.

An air conditioner removes moisture and heat from the room where it is located. One advantage of portable air conditioning units over fitted models is that they can be moved from one room to another in the home or even transferred between different buildings.

The hot air in your room is passed through a coil cooled by refrigerant gas, losing excess heat and moisture before being discharged again into the room.

In single unit models (Pinguino), a small part of this air is used to cool the refrigerant gas before, hot and moist air is being discharged outside.

In suitcase models, the circuit is cooled using the air outside.

ECO by Pinguino is the latest generation of ecological air conditioners. Pinguino does not contain gases dangerous to the earth's ozone layer (CFC/HCFC). In addition, thanks to the extreme efficiency of the appliance, not only does it save you money on your electric bills, but it saves the environment by not negatively contributing to the greenhouse effect."

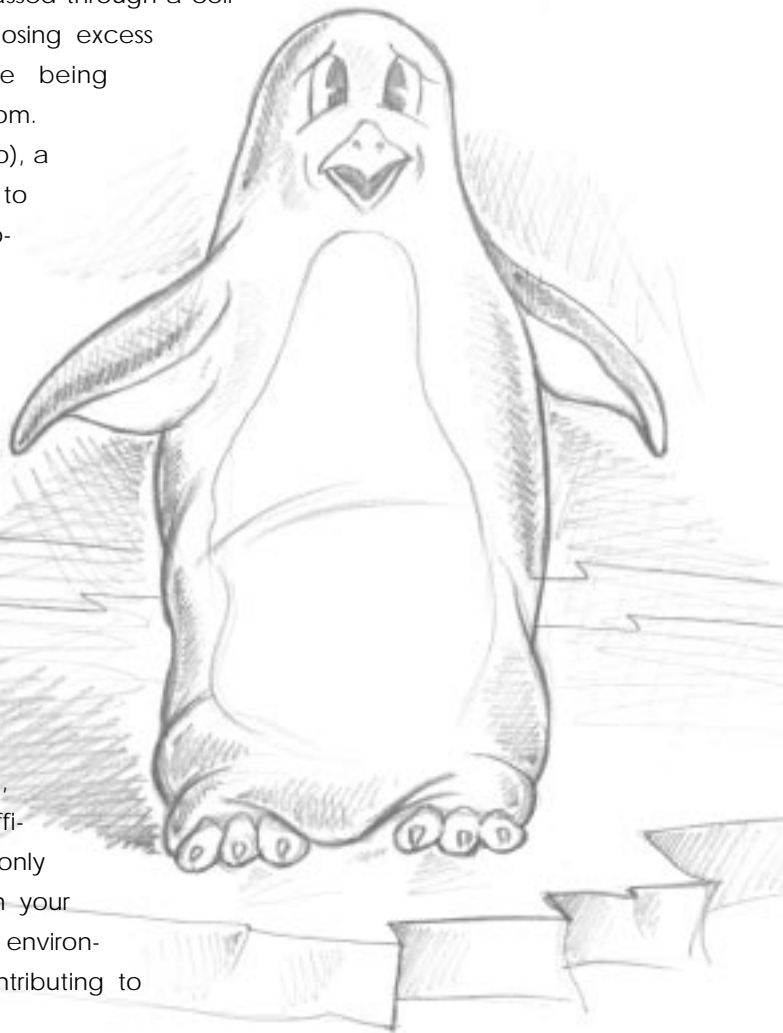

Description and setting up

DESCRIPTION OF THE APPLIANCE

- 1) Remote control unit compartment with cover
- 2) Control panel
- 3) Manual function button
- 4) Air outlet grill
- 5) Open-out handle
- 6) Front panel
- 7) Tray
- 8) Tank
- 9) Reset button
- 10) Air intake grill
- 11) Handle
- 12) Air exhaust hose fitting
- 13) Drain tube
- 14) Air intake grill
- 15) Flange bung
- 16) Air exhaust hose
- 17) Nozzle for air exhaust hose
- 18) Suction cups
- 19) Wheel locks
- 20) Descaling liquid

The following instructions will help you set up your air conditioning unit as efficiently as possible.

AIR CONDITIONING WITHOUT INSTALLATION FOR INSTANT TEMPORARY USAGE

With just a few simple operations, Pinguino will restore comfortable conditions in your room:

- Fix the exhaust hose **16** to the coupling **12** on the back of the unit as shown in figure **A**.

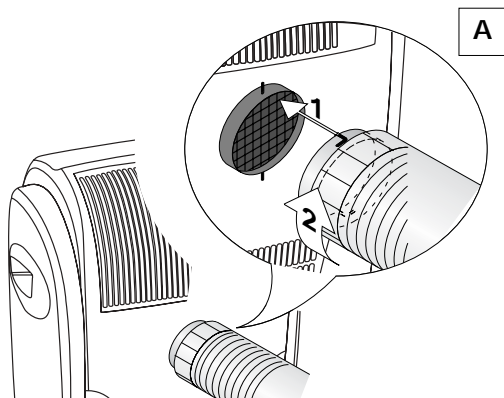

- Fix the window attachment **16** to the end of the hose **17**.
- Place the unit near a window French window or door.
- Open the window, French window or door slightly and place the window attachment **17** as shown in figure **B**.

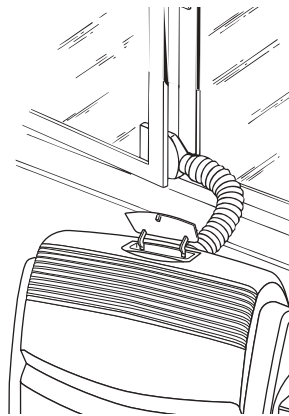

- With a double casement window, use the suckers **18** provided to hold the two halves of the window together (fig. **C**).

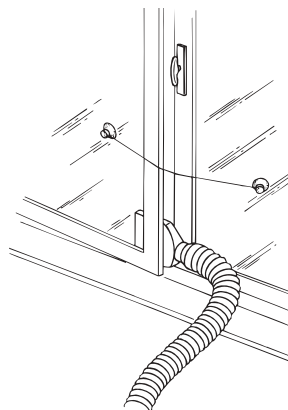

Setting up

AIR CONDITIONING WITH INSTALLATION

For more efficient use Pinguino can also be semi-permanently installed

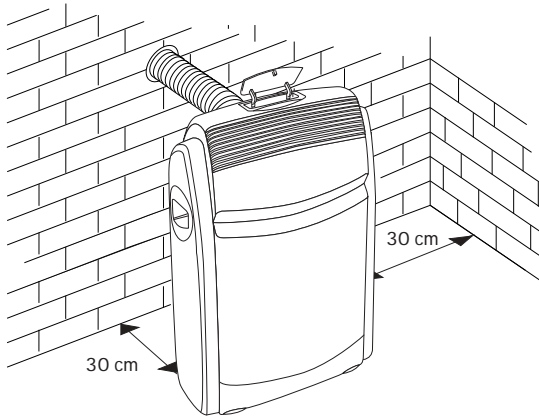

To install, proceed as follows:

- Make a hole in a outside wall or through the glass of a window. Check the height and dimensions given in figure D

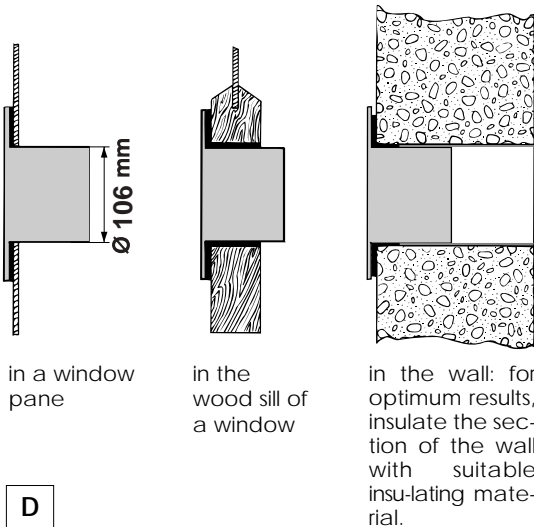

- Fit the flange **15** supplied to the hole.
- Fix the hose **16** to the coupling on the back of the unit (figure A).
- Attach the end of the hose **16** to the flange **15** as shown in the figure E.

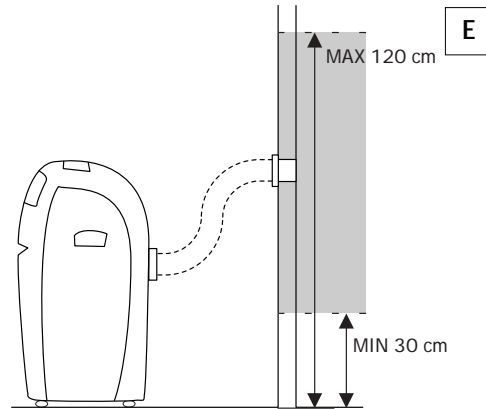

When the hose **16** is not attached, close the hole with the bung on the flange **15**.

NOTE:

When the unit is installed semi-permanently, we recommend leaving a door slightly open (1 cm is enough) to ensure an adequate exchange of air.

Keep the air hoses as short and free of curves as possible to avoid constrictions.

ENGLISH

Preparation for use

HOW TO USE THE AIRCONDITIONER WITH WATER

These air conditioners can use both air and water to cool the condenser (the hot part) of the air conditioner.

To utilise the full potential of your air conditioner, the tank **8** needs to be filled with water. The water is used. To increase the cooling power and reduce the noise level and energy consumption of the air conditioner. The water that is used is then expelled from the machine as water vapour through the exhaust hose **16** (it does not go into room).

Always use clean tap water (which doesn't contain salts). As a rule the water will usually last about 8 hours however this depends on the conditions within the room, such as temperature, humidity, insulation and aspect and number of people. In turbo mode the water will also be used more quickly.

You may also use the air conditioner on air cooling only (without filling the water tank). If you only require the lower cooling power.

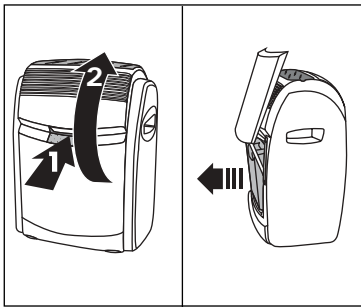

A) To open the front panel **6** grip either side of the panel and gently pull the panel towards you and upwards. Remove the tank **8** Lifting it forward.

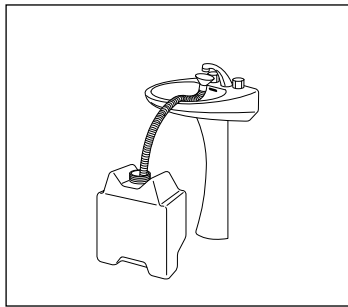

B) Turn the tank upside down and remove the plug, remove the extendible tube and fill the tank, leaving it on the ground.

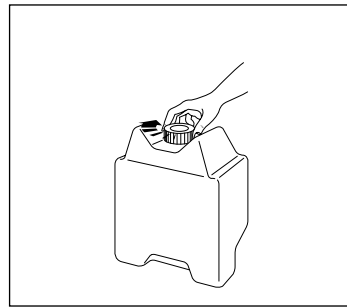

C) After completing the filling procedure, replace the extendible hose, replace the cap and screw it in tightly. Return the tank to its place, with the writing FRONT clearly visible. Carefully hold the panel in the centre and lower to its closed position.

During the "water functioning" operation and in particularly silent locations (eg the bedroom) a slight gurgling sound may be heard. This is completely normal.

IMPORTANT: if the room temperature is 32°C or over the air conditioner must be operated with water in the tank.

Description of the remote control



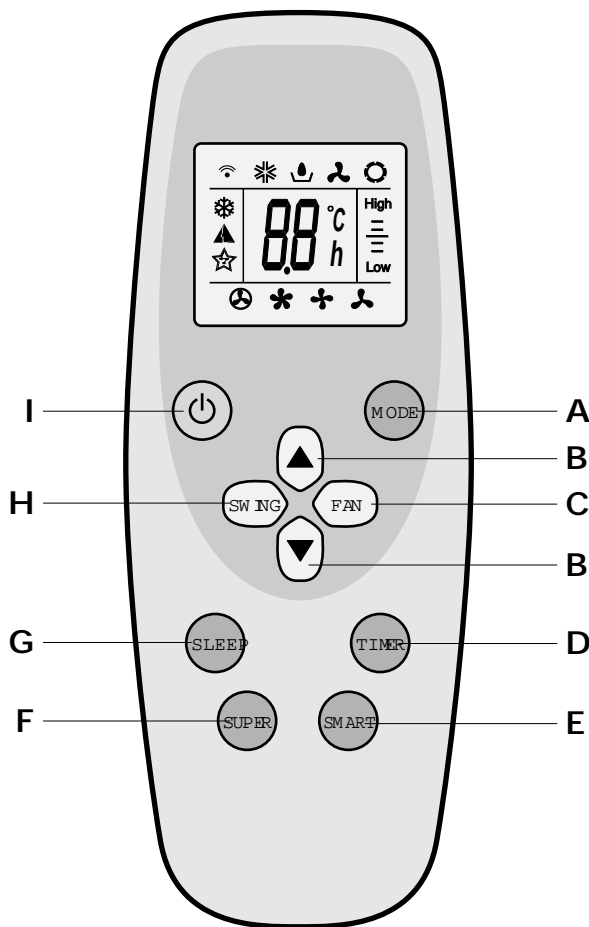









ENGLISH



When the remote control is not used, it can be stored in the foreseen compartment **1**. To open the compartment press "push".

Description of the remote control/ Electrical connection

IL DISPLAY

-  Signal transmission
 -  Air conditioning indicator
 -  Dehumidifying indicator
 -  Fan indicator
 -  Heating indicator (mode not available with this appliance)
 -  SUPER air conditioning indicator
 -  SMART indicator
 -  SLEEP indicator
 -  Automatic fan speed
 -  High fan speed
 -  Medium fan speed
 -  Low fan speed
- High
 Regulates temperature in SMART or Dehumidifying mode.
Low

A. MODE button

Selects the operating mode (air conditioning, dehumidifying, fan).

B. ROOM TEMPERATURE buttons

Set room temperature or programme the timer.

C. FAN button ()

Sets fan speed to automatic, high, medium or low in sequence.

D. TIMER button

Sets or cancels the timer.

E. SMART button ()

When this button is pressed, the appliance automatically establishes the most suitable operating mode for maximum comfort.

F. SUPER button ()

Starts or stops rapid cooling (in the rapid cooling mode, the fan operates at high speed with the temperature automatically set at 18°C).

G. SLEEP button ()

Sets or cancels the automatic SLEEP function.

H. SWING button (wall mounted models only)

Starts or stops swing of the air distribution vertical adjustment fins and sets the required air flow direction upwards or downwards.

I. ON/OFF button

Press this button to turn the appliance on and off. NB: the settings are displayed even when the air conditioner is off.

ELECTRICAL CONNECTION

Before plugging in check that:

- the mains supply corresponds to the value shown in the specifications table;
- the socket and the mains lead correspond to the power requirements of the appliance;
- the socket is suited to the plug otherwise have the socket replaced;
- the socket is properly grounded. **The manufactures cannot be held responsible for any damages due to failure in following normal safety procedures.**

Replacement of the power cable must be carried out by qualified personnel.

Warning lights/Forced operations

THE LEDS

Led displays come on depending on the selected function or as warning of possible anomalies.

ENGLISH

FUNZIONE	GREEN LIGHT	YELLOW LIGHT	BLU LIGHT
OFF	-	-	-
AIR-CONDITIONING	on	-	-
DEHUMIDIFYING	on	-	on
FAN	-	on	-
SMART	As soon as this function is selected, all LED displays will remain on for some seconds until the control unit selects which mode to function in (whether air-conditioning, dehumidifier, fan or heater).		
SUPER	-	-	on
TIMER	TIMER - if the TIMER mode is selected, the indicator lights remain on even when the appliance is off.		

ANOMALY	GREEN LIGHT	YELLOW LIGHT	BLU LIGHT
ALARM*	blinking	blinking	blinking
NO WATER IN TANK	on or off	-	blinking

* Call the Service Centre

FORCED OPERATIONS

This is a way of operating to be selected if there are problems with the remote control (broken or lost, or the batteries run-down).

Press the button **3** until the required mode is selected (air conditioning, dehumidifying, fan, smart, off). Refer to the indicator lights and the table below to identify the mode selected. For each mode selected, the appliance will automatically choose the optimum values for maximum comfort.

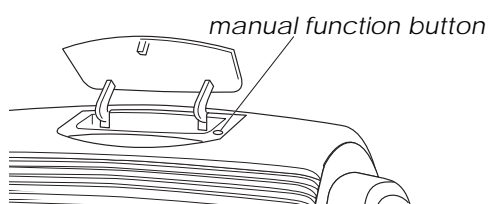

Description of the remote control

REMOTE CONTROL

Inserting the batteries

- Slide the cover as shown in figure.
- Insert two new batteries (not rechargeable) making sure the (+) and (-) are in the correct positions.
- Put the cover back on, letting it slide into its original position.
- The Display will show all of the remote control's symbols for several seconds.

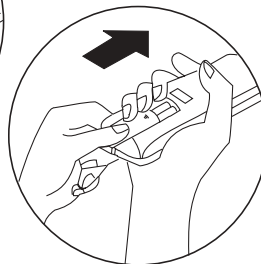
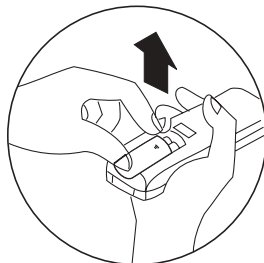
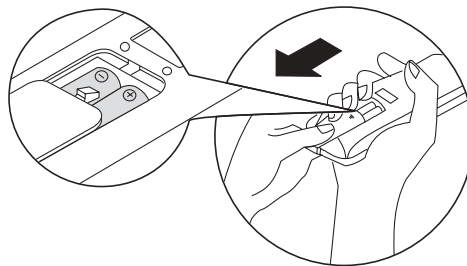

Note: WE SUGGEST USING ALKALINE BATTERIES (LR03).

If the remote control is to be replaced or thrown away, the batteries must be removed and disposed of in accordance with the current laws as it represents an environmental hazard.

When the remote control unit batteries are replaced, the air-conditioning indicator ☼ and heating indicator ⦿ will flash alternately on the remote control unit liquid crystal display.

To set the remote control unit correctly, while ☼ is displayed, press any button.

If you do not press a button within 12 seconds, the remote control unit will also make the heating ⦿ mode available, despite the fact that this function is not available with this appliance.



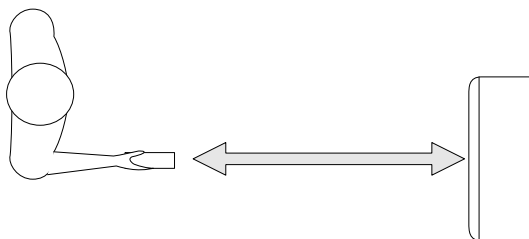

PROPER USE

- Point the remote control unit towards the air-conditioning unit signal receiver **15**.
- Maximum distance: about seven (7) metres (without any obstacle between remote control and receiver).
- The remote control must be handled with **great care**: do not drop it, expose it to direct sunlight, or leave it close to heat sources.



Selecting functions



AIR-CONDITIONING MODE

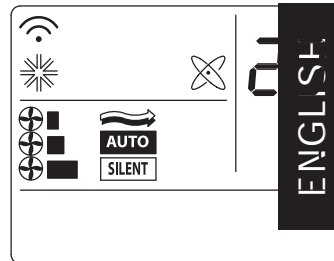

- Press the  button to turn the appliance on.
- A beep indicates that the air-conditioning unit is on and the  symbol flashes on the display
- Press the MODE button a number of times until the air-conditioning symbol  appears on the display.
- Now set the temperature using the   buttons.
- To select fan speed, press the FAN button repeatedly until the required fan speed is selected (automatic, high, medium, low).

NB: in air-conditioning mode, the appliance automatically removes excess moisture from the atmosphere.





DEHUMIDIFYING MODE

- Activate this function when humidity is high.
- Press the  button to turn the appliance on. A beep indicates that the air-conditioning unit is on and the  symbol flashes on the display.
- Press the MODE button a number of times until the dehumidifying symbol  appears on the display.
- Use the buttons to set the required level of dehumidifying.

The   symbol is displayed  High.



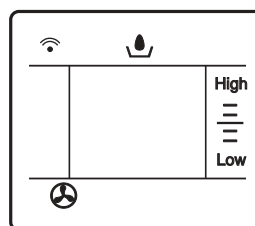

 Low

- Press the  button to increase the dehumidifying level and the  button to reduce it.
- In dehumidifying mode, fan speed is selected by the appliance automatically.



FAN MODE

On humid but not particularly hot days, the fan function alone may be adequate.

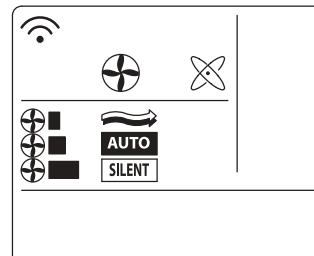

- Press the  button. A beep indicates that the air-conditioning unit is on and the  symbol flashes on the display.
- Press the MODE button a number of times until the fan symbol  appears on the display.
- Once fan mode has been selected, press the FAN button until the required speed is reached (low, medium, high).





Selecting functions

SMART MODE

In SMART mode, the air-conditioning unit decides the best way to operate to guarantee maximum comfort.





- Press the  button to turn the appliance on. A beep indicates that the air-conditioning unit is on and the  symbol flashes on the display.
- Press the SMART button. The appliance functions automatically and the  symbol appears on the display.

NB: in SMART mode, temperature is controlled automatically. However, if the required temperature has not yet been reached, it can be reduced or increased by a maximum of 2° C by pressing the   buttons.

It should be pointed out that when the automatic ventilation functions are activated, the appliance itself will choose the proper speed.

AUTOMATIC SLEEP MODE

The automatic SLEEP mode is ideal for the night-time as it enables operation of the air-conditioning unit in any of the modes (air-conditioning, dehumidifying, fan or SMART) to be gradually reduced until it shuts down completely (after eight hours). To select SLEEP mode, proceed as follows:

- Press the  button to turn the appliance on.
- A beep indicates that the air-conditioning unit is on and the  symbol flashes on the display.
- Press the MODE button a number of times until the symbol of the function required appears on the display.
- Then select the required temperature by pressing the   buttons.
- Now press the SLEEP button to set the night function. The  symbol is displayed. Press the SLEEP button again to go back to the previous mode. In this mode, the fan operates at low speed.

N.B: The night-time function makes it possible to keep a room at a perfect temperature, thus preventing an excessive rise or a drop in temperature while the silent operation is in effect. The air-flow will decrease, while the room temperature will vary gradually to provide the ideal condition: the temperature will increase by 1° C. after 60 minutes and by 2° C. after two hour (it goes off altogether after 8 hours).

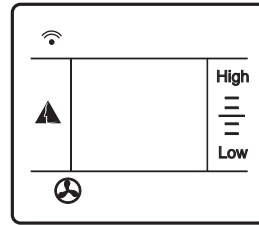

Selecting functions

SUPER MODE

SUPER mode is used to turn rapid cooling on or off. The fan is set to high speed and the temperature is automatically set to 18° C.

To select SUPER mode, proceed as follows:

- Make sure there is water in the tank
- Press the **ⓘ** button to turn the appliance on. A beep indicates that the air-conditioning unit is on and the **📶** symbol flashes on the display.
- Press the SUPER button to set the mode. The **❄️** symbol is displayed.
- **The blue indicator light comes on. If this flashes, the tank needs filling**
- To go back to the previous mode, press the SUPER button again.
- The SUPER function will be deactivated automatically after 15 minutes

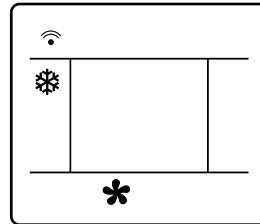

ENGLISH

PROGRAMMING THE TIMER

After selecting the required operating mode, activate the timer by pressing the TIMER button when you go out in the morning to obtain a comfortable room temperature at the time you will be coming home.

Programming the turn-off function

- With the air-conditioning unit on, press the TIMER button. The time is displayed and the "h" symbol flashes. Set the time when you want the appliance to go off using the **▲** **⏸** buttons (from 30 minutes to 24 hours).
- Press the TIMER button again to confirm the selection. A count-down of the time left is displayed.
- At the end of the set time the appliance goes off automatically. During the first ten hours, you can select half hour intervals. For times greater than ten hours, one hour intervals can be selected.
- To cancel the set time, press the TIMER button again. You will hear a beep.

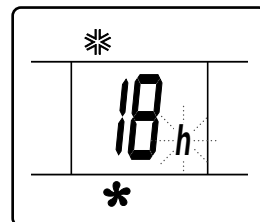

Programming the ON function

- With the air-conditioning unit off, press the TIMER button. The time is displayed and the "h" symbol flashes. Set the time when you want the appliance to come on using the **▲** **⏸** buttons (from 30 minutes to 24 hours).
- Press the TIMER button again to confirm the selection. The three indicator lights on the air-conditioning unit come on.
- At the end of the set time the appliance comes on automatically. During the first ten hours, you can select half hour intervals. For times greater than ten hours, one hour intervals can be selected.
- To cancel the set time, press the TIMER button again. You will hear a beep and the three indicator lights on the air-conditioning unit will go off.

Purification filter

PURIFICATION FILTER

The appliance is provided with a 3M purification filter. This filter is able to capture even the smallest sized particles and impurities (up to 0.003 millimetres), such as cigarette smoke.

The purification filter should never be used with the dust filter, which is also included with the appliance. Therefore:

A. If you wish to use the purification filter:

Remove the purification filter from the filter housing; Remove the aspiration grill **10** (fig. F on page 36) and the dust filter which is attached to this. Remove the purification filter from its packaging. Anchor the filter to the appliance by attaching the two plastic pieces on the filter to the special supports on the air conditioner (see the illustration below). Set the dust filter aside.

B. If the dust filter is sufficient:

Remove the purification filter from the filter housing and set it aside.

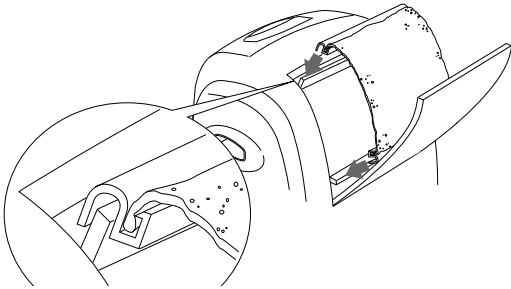

Recommendations

RECOMMENDATIONS

Follow these recommendations to achieve maximum efficiency from your air conditioning unit:

- Close the doors and windows in the room

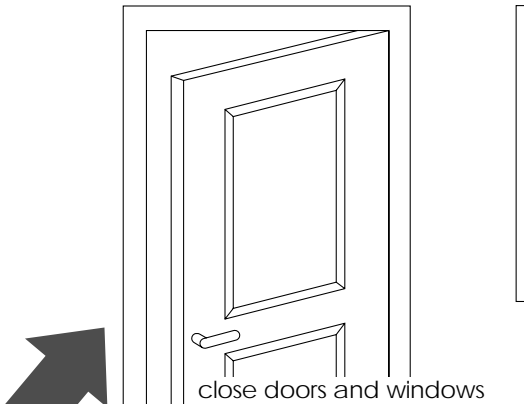

where the unit is functioning. The only exception is in the case of installation through a hole in the wall or window. In this case, you are recommended to allow a small amount of air to enter through a door or window to guarantee an adequate exchange of air.

- Protect the room from direct exposure to the sun's rays by drawing the curtains and/or partially lowering the blinds so as to maximise energy savings.
- Do not rest objects on the air conditioning unit.
- Do not obstruct the air intake **10** or outlet **4**.

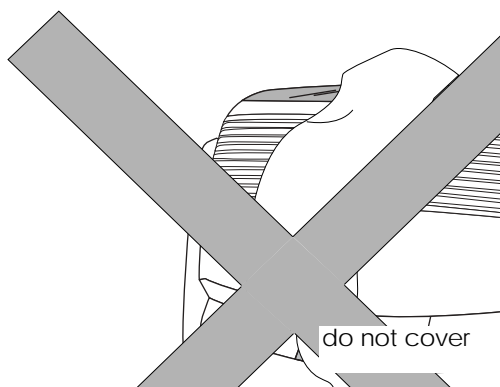

- Make sure there are no heat sources in the room.
- Do not use outdoors.

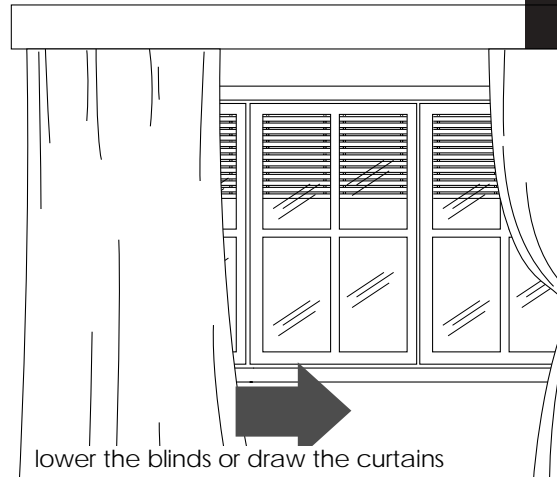

- Make sure the unit is located on a **level** floor. If necessary, place the two blocking devices **19** under the front wheels .

Maintenance

Before cleaning or maintenance, always turn the unit off and unplug from the mains.

CLEANING THE APPLIANCE

We recommend cleaning the appliance with a slightly damp cloth then drying with a dry cloth. For safety reasons, do not wash the air conditioner with water.

Precautions

Never clean with benzene, alcohol or solvents. Never spray liquid insecticide or similar.

CLEANING THE FILTERS

All of the models are equipped with a dust filter able to capture the dust particles suspended in the air.

In order to maintain the effectiveness of your air conditioner unaltered over time, remember to clean the dust filter every two weeks.

1. Remove the aspiration grill **10**, (see fig. F);

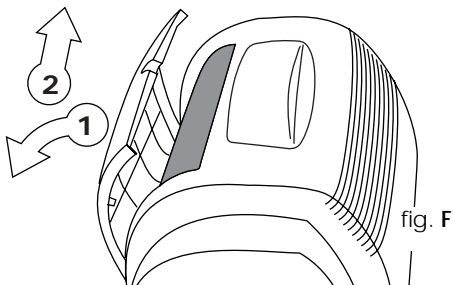

2. Remove the filter holder housing by detaching it from the external grill. To detach it, press on the two wings found on the side of the filter holder (see fig. G)

Use a vacuum cleaner to remove the dust deposits on the filter. If the filter is very dirty,

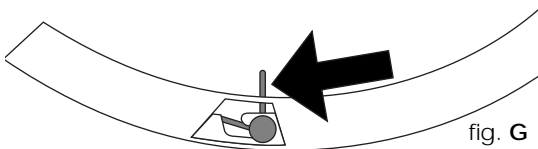

immerse it in warm water, rinsing it thoroughly. The temperature of the water should be kept under 40°C.

After washing it, let the filter dry before re-inserting it into the holder.

CLEANING THE RESERVOIR **7**

It is recommended that you clean this at least once a month using the following method:

- turn off the appliance and remove the plug from the electrical outlet.
- open the front panel **6** and remove the tank **8**.
- remove the bung from the drainage hose **13** which can be found at the back the air conditioner and empty out the water to a container.
- after draining off the water, replace the drainage hose plug.
- remove the dirt by scrubbing gently with a cloth where the tank is positioned.

START OF SEASON CHECKS

Check that the power cable and socket are undamaged and that the earth installation is efficient. Carefully observe the installation instructions.

RECOMMENDED OPERATIONS TO PERFORM AT THE END OF THE SEASON

- 1) Proceed with scaling procedures (see page 37).
- 2) Remove the water from the collection reservoir.
- 3) Operate the appliance in the ventilation only mode for about half an hour in order to thoroughly dry the inside of the air conditioner.
- 4) Turn off the appliance and remove the plug from the outlet.
- 5) Remove the exhaust hose **16**.
- 6) Clean the filter and dry it thoroughly before replacing it in the appliance.

Descaling

When the scale deposits become excessive (on average, after about 400 hours of operation) or in any case, at least once each season, it is very important to proceed with the decalcification of the appliance as described below.

To remove the scale from the appliance, you need:

- 250 ml of descaling liquid [20]
- 750 ml of clean water

Proceed as follows:

- 1) Remove the tank [8] from the appliance and drain the water remaining in the collection reservoir [7] by using the drainage hose [13] (fig. H).
- 2) Close the drainage hose [13]. Pour 250 ml of decalcifying liquid and 1 litre of clean water into the collection reservoir [7] which is found under the tank (fig. I), on the bottom of the appliance.
- 3) Operate the air conditioner for about half an hour (air-conditioning function).
- 4) After this, drain out all of the liquid remaining in the collection reservoir and rinse thoroughly. During the rinsing process, the drainage hose must be open and the appliance functioning.
- 5) Unplug the appliance from the mains and clean the collection reservoir thoroughly with a clean cloth.
- 6) After cleaning the collection reservoir, the air conditioner can be used normally.

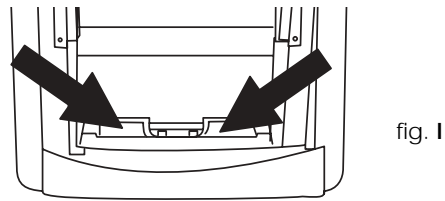
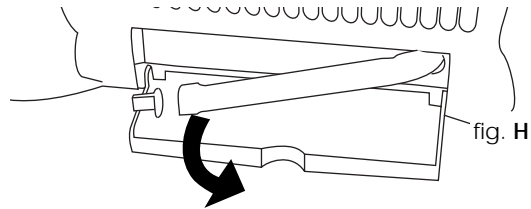

ENGLISH

IF TRACES OF SUDS CAN BE SEEN IN THE WATER WHEN THE MACHINE IS USED AGAIN AFTER IT HAS BEEN CLEANED AS DESCRIBED ABOVE, THIS IS NORMAL HOWEVER, IF THERE ARE A LOT OF SUDS RINSE THE APPLIANCE AGAIN THOROUGHLY TO REMOVE ALL TRACES OF CLEANING PRODUCT.

IF NECESSARY, REQUEST ADDITIONAL QUANTITIES OF DECALCIFYING LIQUID FROM DE' LONGHI LTD.

ATTENTION:

The use of products other than De' Longhi could cause damage to the internal components of the appliance and invalidate the terms of the warranty.

Troubleshooting

PROBLEM	CAUSES	REMEDY
The unit does not work	<ul style="list-style-type: none">the power is offthe plug is not inserted into the electrical outletthe fan is blockedthe appliance's security device has intervened	<ul style="list-style-type: none">restore the powerplug in the appliancecall the Service Centrerestore the appliance by pushing the button 9. If the problem persists, call the Service Centre.
The unit works for only a short time	<ul style="list-style-type: none">the exhaust tube is twistedthe exhaust tube is blockedthe drain tube is bent	<ul style="list-style-type: none">position exhaust tube correctlycheck if there are obstacles blocking the exhaust of air out of the applianceunbend the tube
The unit works but does not cool the room	<ul style="list-style-type: none">a window is openin the room there is some source of heat (lamp, burner, etc.) or there are many people in the roomthe thermostat is set too highthe air filter is dirtythe air conditioner has a capacity not adequate for the conditions or the dimensions of the room	<ul style="list-style-type: none">close the open windowremove the heat sourceset the thermostat to a lower (remote control)clean the filter or replace
Remote control signals are weak or inexistent	<ul style="list-style-type: none">Batteries run downBatteries may be inserted incorrectly	<ul style="list-style-type: none">Change the batteriesCheck the batteries' (+) and (-) poles
Strange odour in the room	<ul style="list-style-type: none">air filters dirty	<ul style="list-style-type: none">clean the filter or replace it
The air conditioner doesn't work for about 3 min from turning on the appliance	<ul style="list-style-type: none">the appliance's security system has intervened	<ul style="list-style-type: none">wait for 3 minutes

TECHNICAL SPECIFICATION

Power supply	see rating plate
Max. absorbed power in air conditioning	"
Refrigerating capacity	"
Refrigerant	"
Number of fan speeds	3 + silent
Max. air flow .	370 m ³ /h

ENGLISH

RECOMMENDED OPERATING CONDITIONS

Room temperature	21 ÷ 35°C
------------------	-----------

Dimensions:

• width	580 mm
• height	785 mm
• depth	435 mm

ELECTRICAL CONNECTION (U.K. ONLY)

A) If your appliance comes fitted with a plug, it will incorporate a 13 Amp fuse. If it does not fit your socket, the plug should be cut off from the mains lead, and on appropriate plug fitted, as below. warning: Very carefully dispose of the cut off plug after removing the fuse: do not insert in a 13 Amp socket elsewhere in the house as this could cause a shock hazard. With alternative plugs not incorporating a fuse, the circuit must be protected by a 15 Amp fuse. If the plug is a moulded-on type, the fuse cover must be re-fitted when changing the fuse using a 13 Amp Asta approved fuse to BS 1362. In the event of losing the fuse cover, the plug must NOT be used until a replacement fuse cover can be obtained from your nearest electrical dealer. The colour of the correct replacement fuse cover is that as marked on the base of the plug.

B) If your appliance is not fitted with a plug, please follow the instructions provided below:

WARNING - THIS APPLIANCE MUST BE EARTHED

IMPORTANT

The wires in the mains lead are coloured in accordance with the following code:

Green and yellow	Earth
Blue	Neutral
Brown	Live



As the colours of the wires in the mains lead may not correspond with the coloured markings identifying the terminals in your plug, proceed as follows:

The green and yellow wire must be connected to the terminal in the plug marked with the letter E or the earth symbol or coloured green or green and yellow.

The blue wire must be connected to the terminal marked with the letter N or coloured black.

The brown wire must be connected to the terminal marked with the letter L or coloured red.

Free Manuals Download Website

<http://myh66.com>

<http://usermanuals.us>

<http://www.somanuals.com>

<http://www.4manuals.cc>

<http://www.manual-lib.com>

<http://www.404manual.com>

<http://www.luxmanual.com>

<http://aubethermostatmanual.com>

Golf course search by state

<http://golfingnear.com>

Email search by domain

<http://emailbydomain.com>

Auto manuals search

<http://auto.somanuals.com>

TV manuals search

<http://tv.somanuals.com>