



De'Longhi Appliances
via Seitz, 47
31100 Treviso Italia

5713214281/07.10

BEAN TO CUP ESPRESSO AND CAPPUCCINO MACHINE



ESAM 04.320

ELECTRICAL REQUIREMENTS

Before using this appliance ensure that the voltage indicated on the product corresponds with the main voltage in your home, if you are in any doubt about your supply contact your local electricity company.

The flexible mains lead is supplied connected to a B.S. 1363 fused plug having a fuse of 13 amp capacity.

Should this plug not fit the socket outlets in your home, it should be cut off and replaced with a suitable plug, following the procedure outlined below.

Note: Such a plug cannot be used for any other appliance and should therefore be properly disposed of and not left where children might find it and plug it into a supply socket - with the obvious consequent danger.

N.B. We recommend the use of good quality plugs and wall sockets that can be switched off when the machine is not in use.

IMPORTANT: the wires in the mains lead fitted to this appliance are coloured in accordance with the following code:

GREEN AND YELLOW	EARTH
BLUE	NEUTRAL
BROWN	LIVE

Green and Yellow to Earth

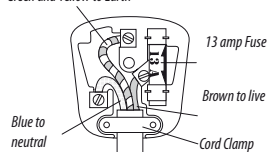

As the colours of the wires in the mains lead of this appliance may not correspond with the coloured markings identifying the terminals in your plug, proceed as follows:

- The wire which is coloured green and yellow must be connected to the terminal in the plug which is marked with the letter E or by the earth symbol  or coloured green or green and yellow.
- The wire which is coloured blue must be connected to the terminal which is marked with the letter N or coloured black.
- The wire which is coloured brown must be connected to the terminal which is marked with the letter L or coloured red.

When wiring the plug, ensure that all strands of wire are securely retained in each terminal. Do not forget to tighten the mains lead clamp on the plug. If your electricity supply point has only two pin socket outlets, or if you are in doubt, consult a qualified electrician.

Should the mains lead ever require replacement, it is essential that this operation be carried out by a qualified electrician and should only be replaced with a flexible cord of the same size.

After replacement of a fuse in the plug, the fuse cover must be refitted. If the fuse cover is lost, the plug must not be used until a replacement cover is obtained. The colour of the correct replacement fuse cover is that of the coloured insert in the base of the fuse recess or elsewhere on the plug. Always state this colour when ordering a replacement fuse cover.

Only 13amp replacement fuses which are asta approved to B.S. 1362 should be fitted.

This appliance conforms to the Norms EN 55014 regarding the suppression of radio interference.

Warning - this appliance must be earthed

A

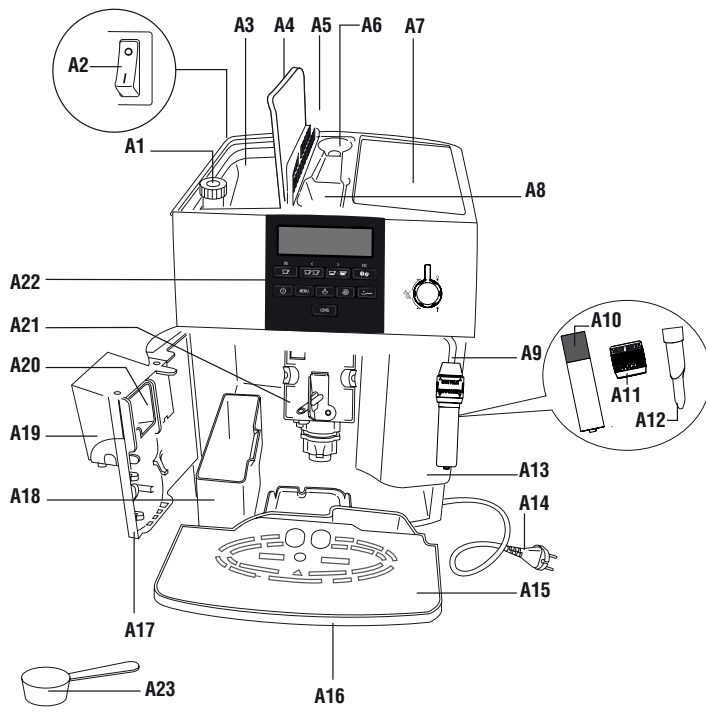

B

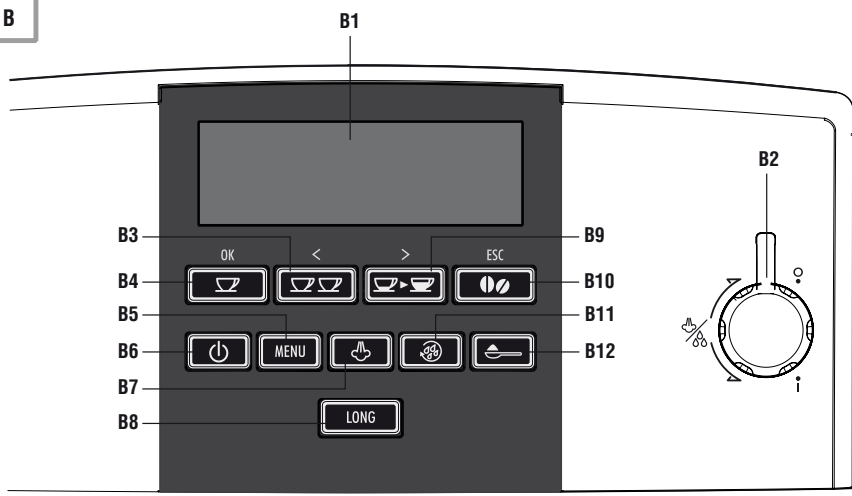

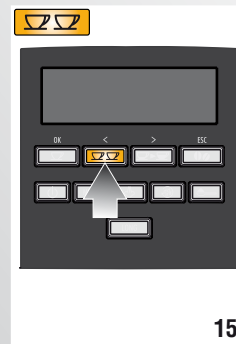
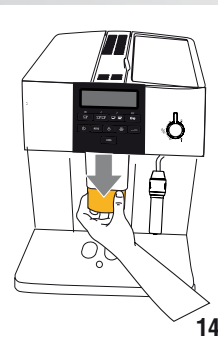
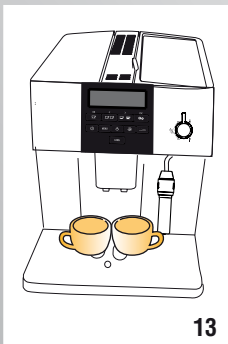
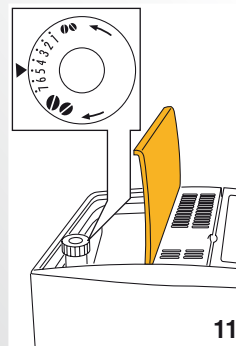
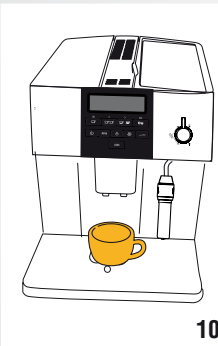
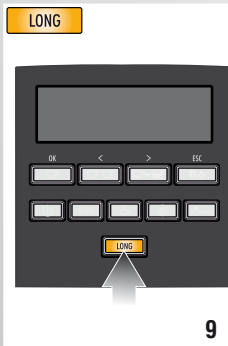
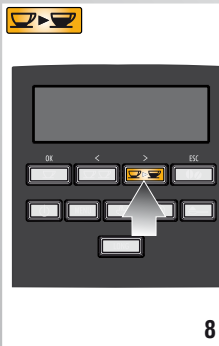
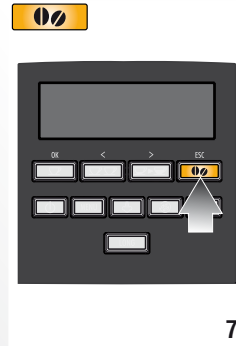
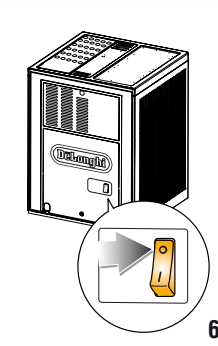
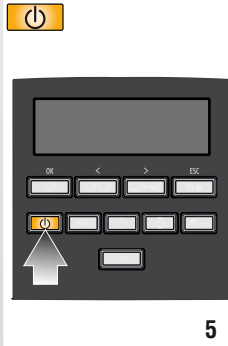
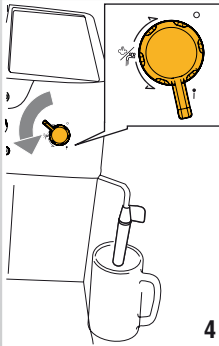
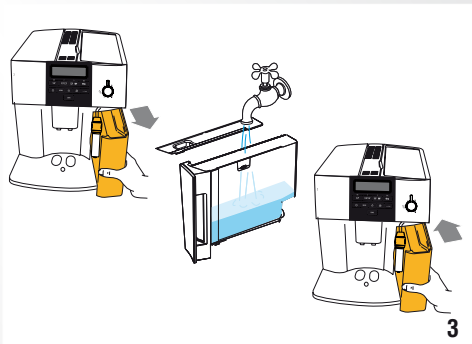
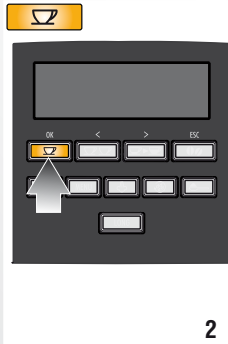
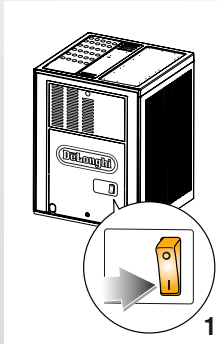

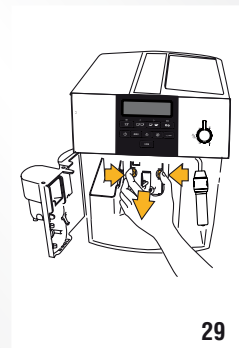
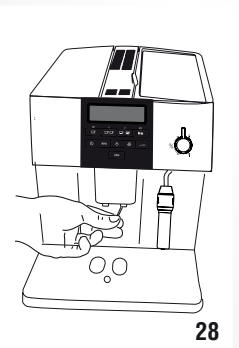
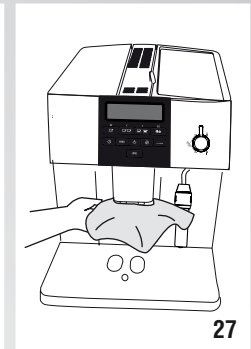
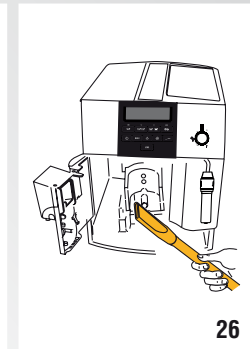
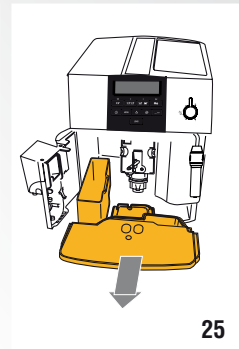
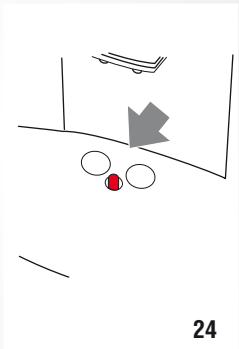
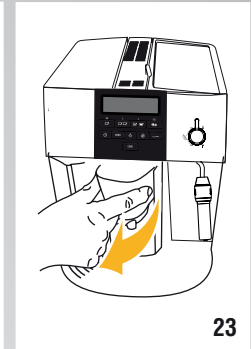
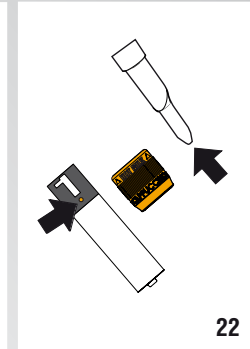
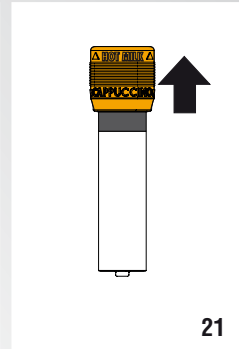
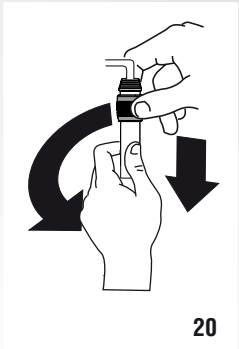
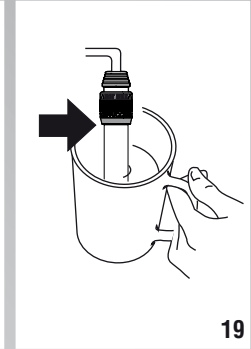
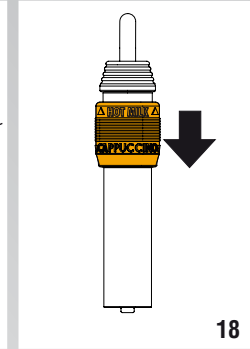
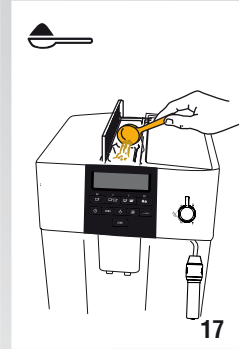
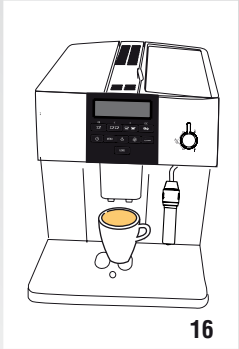

CONTENTS

INTRODUCTION	7
Symbols used in these instructions	7
Letters in brackets	7
Troubleshooting and repairs	7
SAFETY	7
Fundamental safety warnings	7
DESIGNATED USE	7
INSTRUCTIONS	8
DESCRIPTION	8
Description of the appliance	8
Description of control panel	8
PRELIMINARY CHECKS	9
Checking the appliance	9
Installing the appliance	9
Connecting the appliance	9
Using the appliance for the first time	9
TURNING THE APPLIANCE ON	9
TURNING THE APPLIANCE OFF	9
MENU SETTINGS	10
Descaling	10
Setting the language	10
Energy Saving	10
Cup warmer	10
Adjust time	10
Auto-Start	10
Auto-Off (Stand-by)	11
Setting the temperature	11
Setting water hardness	11
Statistics function	11
Default values (reset)	11
MAKING COFFEE	11
Selecting the coffee taste	11
Selecting the quantity of coffee in the cup	11
Customising the espresso "my coffee" quantity	12
Programming the long "my coffee" quantity	12
Adjusting the coffee mill	12
Tips for a hotter coffee	12
Making espresso coffee using coffee beans	12
Making long coffee using coffee beans	13
Making espresso or long coffee using pre-ground coffee	13
MAKING FROTHED MILK (FOR CAPPUCCINO) AND HOT MILK	13
Making hot milk	14
Cleaning the cappuccino maker after use	14
HEATING WATER	14
Preparation	14

CLEANING	14
Cleaning the coffee maker	14
Cleaning the coffee grounds container	14
Cleaning the drip tray	14
Cleaning the inside of the machine	15
Cleaning the water tank	15
Cleaning the coffee spouts	15
Cleaning the pre-ground coffee funnel	15
Cleaning the infuser	15
DESCALING	15
SETTING WATER HARDNESS	16
Measuring water hardness	16
Set water hardness	16
TECHNICAL SPECIFICATION	16
DISPOSAL	17
DISPLAYED MESSAGES	18
TROUBLESHOOTING	19

INTRODUCTION

Thank you for choosing the ESAM04.320 automatic coffee and cappuccino maker.

We hope you enjoy using your new appliance.

Take a few minutes to read these instructions.

This will avoid all risks and damage to the machine.

Symbols used in these instructions

Important warnings are identified by these symbols.

These warnings must absolutely be respected.



Danger!

Failure to observe the warning could result in possibly life threatening injury from electric shock.



Important!

Failure to observe the warning could result in injury or damage to the appliance.



Danger of burns!

Failure to observe the warning could result in scalds or burns.



Please note :

This symbol identifies important advice or information for the user.

Letters in brackets

The letters in brackets refer to the legend in the Description of the appliance on page 3.

Troubleshooting and repairs

In the event of problems, first try and resolve them following the information given in the sections "Displayed messages" on page 18 and "Troubleshooting" on page 19.

If this does not resolve the problem or you require further information, you should consult Customer Services by calling the number given on the annexed "Customer Service" sheet.

If your country is not among those listed on the sheet, call the number given in the guarantee.

If repairs are required, contact De'Longhi Customer Services only.

The addresses are given in the guarantee certificate provided with the machine.

SAFETY

Fundamental safety warnings



Danger!

This is an electrical appliance and may cause electric shock.

You should therefore respect the following safety warnings:

- Never touch the appliance with damp hands or feet.
- Never touch the plug with damp hands.
- Make sure the socket used is freely accessible at all times, enabling the appliance to be unplugged when necessary.
- Unplug directly from the plug only. Never pull the power cable as you could damage it.
- To disconnect the appliance completely, place the main switch at the back of the appliance in the 0 position (fig. 6).
- If the appliance is faulty, do not attempt to repair. Turn it off, unplug from the mains socket and contact Customer Services.
- If the plug or power cable is damaged, it must be replaced by De'Longhi Customer Services only to avoid all risk.



Important!

- Keep all packaging (plastic bags, polystyrene foam) away from children.
- The appliance is not intended for use by persons (including children) with reduced physical, sensory or mental capabilities, or lack of experience and knowledge, unless they have been given supervision or instruction concerning use of the appliance by a person responsible for their safety. Children must be supervised to ensure they do not play with the appliance.



Danger: Risk of burns!

This appliance produces hot water and steam may form while it is in operation.

Avoid contact with splashes of water or hot steam.

DESIGNATED USE

This appliance is designed and made to prepare coffee and heat drinks. All other use is considered improper. This appliance is not suitable for commercial use. The manufacturer is not liable for damage deriving from improper use of the appliance. This is a household appliance only.

It is not intended for use in:

- staff kitchen areas in shops, offices and other working environments;
- farm houses;
- by clients in hotels, motels and other residential type environments;
- bed and breakfast type environments.



INSTRUCTIONS

Read these instructions carefully before using the appliance.

- Failure to respect these instructions may result in burns or damage to the appliance.
The manufacturer is not liable for damage deriving from failure to respect these instructions.



Please note:

Keep these instructions. If the appliance is passed to other persons, they must also be provided with these instructions.

DESCRIPTION

Description of the appliance









(page 3 - **A**)

- A1. Grinding adjustment knob
- A2. Main switch
- A3. Beans container
- A4. Beans container lid
- A5. Cover for funnel and measure compartment
- A6. Measure compartment
- A7. Cup shelf (cup warmer enabled from settings menu)
- A8. Pre-ground coffee funnel
- A9. Steam spout
- A10. Cappuccino maker (removable)
- A11. Cappuccino/hot milk selection ring
- A12. Steam nozzle (removable)
- A13. Water tank
- A14. Power cable
- A15. Cup tray
- A16. Drip tray
- A17. Service door
- A18. Grounds tray
- A19. Coffee spout (adjustable height)
- A20. Coffee guide
- A21. Infuser
- A22. Control panel

Description of control panel

(page 3 - **B**)

A number of buttons on the panel have a dual function. This is indicated in brackets in the description.

- B1. Display: guides the user in using the appliance.
- B2. Steam/hot water knob
- B3.  button: to deliver two cups of coffee (*When you access the MENU: to change menu items and parameters*)
- B4.  button: to make 1 cup of coffee (*When you access the MENU: OK to confirm menu parameters*)
- B5. **MENU** button: to access the settings menu.
- B6.  button: to turn the appliance on and off (stand-by)
- B7.  button: to select the steam function.
- B8. **LONG** button: to deliver one cup of LONG coffee.
- B9.  button: to select coffee quantity (*When you access the MENU: to change menu items and parameters*)
- B10.  button: to select coffee taste (*When you access the MENU: ESC to exit the menu*)
- B11.  button: to perform a rinse cycle
- B12.  button: to make 1 cup using pre-ground coffee



PRELIMINARY CHECKS

Checking the appliance

After removing the packaging, make sure the product is complete and undamaged and that all accessories are present. Do not use the appliance if it is visibly damaged. Contact De'Longhi Customer Services.

Installing the appliance



Important!

When you install the appliance, you should respect the following safety warnings:

- The appliance gives off heat. After positioning the appliance on the worktop, leave a space of at least 3 cm between the surfaces of the appliance and the side and rear walls and at least 15 cm above the coffee maker.
- Water penetrating the appliance could cause damage. Do not place the appliance near taps or sinks.
- The appliance could be damaged if the water it contains freezes. Do not install the appliance in a room where the temperature could drop below freezing point.
- Arrange the power cable in such a way that it cannot be damaged by sharp edges or contact with hot surfaces (e.g. electric hot plates).

Connecting the appliance



Important!

Check that the mains power supply voltage corresponds to the value indicated on the rating plate on the bottom of the appliance.

Connect the appliance to an efficiently earthed and correctly installed socket with a minimum current rating of 10A only. If the power socket does not match the plug on the appliance, have the socket replaced with a suitable type by a qualified professional.

Using the appliance for the first time



Please note:

- Coffee has been used to factory test the appliance and it is therefore completely normal for there to be traces of coffee in the grinder. The machine is, however, guaranteed to be new.
 - You should customise water hardness as soon as possible following the instructions in the section "Setting water hardness" on page 16.
1. Plug the appliance into the mains socket and place the main switch on the back of the appliance in the I position (fig. 1).

You must first choose the language (the languages scroll through at intervals of about 3 seconds).

2. When "English" appears, press the **OK** button (fig. 2) for a few seconds until "ENGLISH set" is displayed.

Follow the instructions indicated by the appliance:

3. "FILL TANK": remove the water tank, fill to the MAX line with fresh water then replace in the appliance (fig. 3).
4. Turn the cappuccino maker outwards and place a container with a minimum capacity of 100 ml underneath (fig. 4).
5. "TURN STEAM KNOB" is displayed. When the steam knob is turned to the I position (fig. 4), "Hot water Press OK" is displayed.
6. Press the **OK** button (fig. 2).

"Please wait" is displayed and the appliance begins to deliver water from the hot water spout.

The appliance ends the first start up procedure, then the message "Turning off, Please wait" is displayed and the appliance goes off.

The coffee maker is now ready for normal use.



Please note:

- When using the appliance for the first time, you need to make 4-5 cups of coffee or 4-5 cappuccinos before the appliance starts to give satisfactory re-sults.

TURNING THE APPLIANCE ON



Please note:

Before turning the appliance on, make sure the main switch on the back of the appliance is in the I position (fig. 1).

Each time the appliance is turned on, it performs an automatic preheat and rinse cycle which cannot be interrupted.

The appliance is ready for use only after completion of this cycle.



Danger of burns!

During rinsing, a little hot water comes out of the coffee spouts and is collected in the drip tray underneath.

Avoid contact with splashes of water.

- To turn the appliance on, press the  button (fig. 5). The message "Heating up, Please wait" is displayed.

After heating, the message "Rinsing" is displayed. As well as heating the boiler, the appliance also heats the internal circuits by circulating hot water.

The appliance is at temperature when the message indicating the taste and quantity of coffee appears.

TURNING THE APPLIANCE OFF

Each time the appliance is turned off, it performs an automatic rinse cycle which cannot be interrupted.

Important!

To avoid damaging the appliance, always press the  button (fig. 5) to turn off.

Danger of burns!

During rinsing, a little hot water flows from the coffee spouts. Avoid contact with splashes of water.

To turn the appliance off, press the  button (fig. 5). The appliance performs a rinse cycle then goes off.

Please note:

If the appliance is not used for an extended period, place the main switch in the **0** position (fig. 6).

Never place the main switch in the **0** position while the appliance is on.

MENU SETTINGS

When you access the settings menu by pressing the MENU button, the following menu items can be selected: Descale, Set language, Energy saving, Cup warmer, Adjust time, Auto-start, Auto-off, Set temperature, Water hardness, Statistics, Default values.

Descaling

For instructions on descaling, see page 15.

Setting the language

To modify the language of the display, proceed as follows:

1. Press the **MENU** button to enter the settings menu.
2. Press the **<** or **>** button until "Set language" is displayed;
3. Press the **OK** button;
4. Press the **<** or **>** button until the required language is displayed;
5. Press the **OK** button to confirm;
6. Press the **ESC** button exit the menu.

Energy Saving

Use this function to enable or disable "Energy saving" mode.

When enabled, the function reduces energy consumption in compliance with European regulations.

To enable or disable the function, proceed as follows:

1. Press the **MENU** button to enter the settings menu.
2. Press the **<** or **>** button until "Energy saving" is displayed;
3. Press the **OK** button. "Disable?" is displayed (or "Enable?" if the function has already been disabled).
4. Press the **OK** button to disable or enable the function or the **ESC** button a number of times to exit the menu.

When the function is active, if the machine is not used for about 1 minute, "Energy saving" is displayed.

Please note!

- To exit the "Energy saving" mode, first press a button, then press the button relative to the desired drink.
- A few seconds may elapse between "Energy saving" mode and delivery of the first drink; "Preparation underway..." is displayed.

Cup warmer

This function enables the cup warmer to be enabled or disabled. Proceed as follows:

1. Press the **MENU** button to enter the settings menu.
2. Press the **<** or **>** button until "Cup warmer" is displayed;
3. Press the **OK** button. "Enable?" is displayed (or "Disable?" if the function has already been enabled).
4. Press the **OK** button to enable or disable the function or the **ESC** button a number of times to exit the menu.

Warming the cups keeps the coffee hot.

Adjust time

To adjust the time on the display, proceed as follows:

1. Press the **MENU** button to enter the settings menu.
2. Press the **<** or **>** button until "Adjust time" is displayed;
3. Press the **OK** button. The hours flash on the display;
4. Press the **<** or **>** button to change the hours;
5. Press the **OK** button to confirm. The minutes flash on the display;
6. Press the **<** or **>** button to change the minutes;
7. Press the **OK** button to confirm;
8. Press the **ESC** button to exit the settings menu.

Please note!

The display shows the time when the appliance is in stand-by or the energy saving mode is enabled: if the time is not set, the display shows "0:00" blinking.

Auto-Start



You can set the auto-start time in order to have the appliance ready at a certain time (for example in the morning) so you can make coffee immediately.

Please note!

To enable this function, **the time must be set correctly.**

To enable Auto-on, proceed as follows:

1. Press the **MENU** button to enter the settings menu.
2. Press the **<** or **>** button until "Auto-start" is displayed;
3. Press the **OK** button. "Enable?" is displayed;
4. Press the **OK** button. The hours flash on the display;
5. Press the **<** or **>** button to select the hours;
6. Press the **OK** button to confirm. The minutes flash on the display;
7. Press the **<** or **>** button to change the minutes;

- Press the **OK** button to confirm. The  symbol appears under "Auto-start" on the display.
- Press the **ESC** button to exit the menu. When the appliance is in stand-by, the  symbol appears next to the clock to indicate that auto-start has been programmed.

To disable the function:

- Press the **MENU** button to enter the settings menu.
- Press the **<** or **>** button until "Auto-start" is displayed;
- Press the **OK** button. "Disable?" is displayed;
- Press the **OK** button to confirm;
- Press the **ESC** button to exit the menu. When the appliance is in stand-by, the  symbol is no longer displayed.

Auto-Off (Stand-by)

The appliance is set by default to go off if not used for two hours.

The time can be changed so that the appliance switches off after 15 or 30 minutes, or after 1, 2 or 3 hours.

To re-programme Auto-off, proceed as follows:

- Press the **MENU** button to enter the settings menu.
- Press the **<** or **>** button until "Auto-off" is displayed;
- Press the **OK** button;
- Press the **<** or **>** button until the required time (15 or 30 minutes, or 1, 2 or 3 hours) is displayed;
- Press the **OK** button to confirm;
- Press the **ESC** button exit the menu.

Auto-off is programmed.

Setting the temperature

To modify the temperature of the water used to make the coffee, proceed as follows:

- Press the **MENU** button to enter the settings menu.
- Press the **<** or **>** button until "Set temperature" is displayed;
- Press the **OK** button;
- Press the **<** or **>** button until the required temperature is displayed (● = low; ●●●● = high);
- Press the **OK** button to confirm;
- Press the **ESC** button exit the menu.

Setting water hardness

For instructions on setting water hardness, see page 16.

Statistics function

This displays statistics relating to the machine. To display, proceed as follows:

- Press the **MENU** button to enter the settings menu.
- Press the **<** or **>** button until "Statistics" is displayed;
- Press the **OK** button;
- Press the **<** or **>** button, you can check:
 - how many coffees have been made;

- how many times the machine has been descaled.
 - the total number of litres of water delivered.
- Press the **ESC** button twice to exit the menu.

Default values (reset)

This resets all menu settings and programmed quantities back to the default values (with the exception of the language which remains as set).

- Press the **MENU** button to enter the menu;
- Press the **<** or **>** button until "Default values" is displayed;
- Press the **OK** button;
- The message "Confirm?" is now displayed.
- Press the **OK** button to confirm and exit.

MAKING COFFEE

 *Please note!*

A few seconds may elapse between "Energy saving" mode and delivery of the first coffee.

Selecting the coffee taste

The appliance is set by default to make coffee with a standard taste.

You can also choose one of these tastes:

- Extra-mild taste
- Mild taste
- Standard taste
- Strong taste
- Extra-strong taste

To change the taste, press the  button (fig. 7) repeatedly until the required taste is displayed.

Selecting the quantity of coffee in the cup

The appliance is set by default to make a standard quantity of coffee.

To select the quantity of coffee, press the  button (fig. 8) repeatedly until the message corresponding to the required quantity of coffee is displayed:



Corresponding coffee	ESPRESSO (ml)	LONG COFFEE (ml)
MY COFFEE	program. from 20 to 180	program. from 20 to 250
SHORT	≈40	≈ 125
STANDARD	≈60	≈ 175
LONG	≈90	≈ 210
EXTRA LONG	≈120	≈ 250



Customising the espresso “my coffee” quantity

The appliance is set by default to automatically deliver 30 ml of espresso “MY COFFEE”.

To modify these settings, proceed as follows:

1. Place a cup under the coffee spouts (fig. 10).
2. Press the  button repeatedly (fig. 8) until “MY COFFEE” is displayed.
3. Keep the  button (fig. 2) pressed until the message “Program quantity” is displayed. Release the button. The machine starts making the coffee;
4. As soon as the coffee in the cup reaches the required level, press the  button again.

The quantity set has now been programmed.

Programming the long “my coffee” quantity

The appliance is set by default to automatically deliver about 100ml of LONG “MY COFFEE”. To modify this quantity, proceed as follows:

1. Place a cup under the coffee spouts (fig. 16).
2. Press the  button repeatedly (fig. 8) until “MY COFFEE” is displayed.
3. Keep the **LONG** button (fig. 9) pressed until the message “Program quantity” is displayed. Release the button. The machine starts making the coffee;
4. As soon as the coffee in the cup reaches the required level, press the **LONG** button again.

The quantity set has now been programmed.

Adjusting the coffee mill

The coffee mill is set by default to prepare coffee correctly and should not require regulating initially.

However, if after making the first few coffees you find that delivery is either too fast or too slow (a drop at a time), this can be corrected by adjusting the grinding adjustment knob (fig. 11).



Please note!

The grinding adjustment knob must only be turned when the coffee mill is in operation.

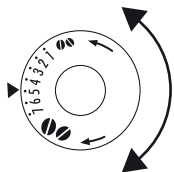

For faster delivery (not a drop at a time), turn one click clockwise towards “7” (coarser ground coffee). For fuller bodied creamier coffee, turn one click anticlockwise towards “1” (finer ground coffee).

These adjustments will only be evident after at least 2 cups of coffee have been delivered.

If delivery is still too fast or too slow, repeat the correction, turning the knob another click.

Tips for a hotter coffee

For a hotter coffee, you are recommended to:



- before delivering the coffee, perform a rinsing cycle by pressing the  button to select the “Rinsing” function. Hot water is delivered from the spout, heating the internal circuits of the appliance and thus raising the coffee temperature.
- If “Cup warmer” mode has been enabled, place the cups on the cup warmer until they are warm.
- warm the cups by rinsing them with hot water (us-ing the hot water function);
- set the “high” coffee temperature (●●●●) in the menu.

Making espresso coffee using coffee beans



Important!





Do not use caramelised or candied coffee beans as they could stick to the coffee mill and make it unusable.

1. Fill the container with coffee beans (fig. 12).
2. Place under the coffee spouts:
 - 1 cup, if you want to make 1 coffee (fig. 10);
 - 2 cups, if you want 2 coffees (fig. 13);
3. Lower the spouts as near as possible to the cup. This makes a creamier coffee (fig. 14).
4. Press the button corresponding to the number of coffees required (1 cup  or 2 cups  (fig. 2 and 15).
5. Preparation begins. The quantity and taste of coffee selected is displayed together with a progress bar which gradually fills as preparation progresses.

Once the coffee has been made, the appliance pre-pares for use again.



Please note:

- While the machine is making coffee, delivery can be interrupted at any moment by pressing one of the coffee buttons ( or ).
- At the end of delivery, to increase the quantity of coffee in the cup, just press (within 3 seconds) one of the coffee buttons ( or .

Once the coffee has been made, the appliance is ready to use again.



Important!

If the coffee is delivered a drop at a time, too fast and not creamy enough or too cold, read the tips in the “Troubleshooting” section on page 19.

Various alarm messages could be displayed while using the machine. Their meaning is explained in the section “Displayed messages” (page 18).

Making long coffee using coffee beans

 *Please note!*

When this function is enabled, a long coffee similar to drip coffee is obtained.

 *Important!*

Do not use caramelised or candied coffee beans as they could stick to the coffee mill and make it unusable.

1. Fill the container with coffee beans (fig. 12);
2. Adjust the height of the spout according to the cup used. Put the cup for long coffee under the spouts (fig. 16);
3. Press the **LONG** button (fig. 9). Preparation begins. A progress bar appears on the display and gradually advances as the procedure progresses.

Once the coffee has been made, the appliance pre-pares for use again.

 *Please note:*

- While the machine is making coffee, delivery can be interrupted at any moment by pressing the **LONG** button.
- Only one cup of long coffee can be made at a time.
- When delivering more than 125 ml, the appliance automatically grinds more coffee halfway through delivery.

Making espresso or long coffee using pre-ground coffee



 *Important!*

- Never add pre-ground coffee when the machine is off or it could spread through the inside of the machine and dirty it. This could damage the appliance.
- Never use more than one level measure or it could dirty the inside of the machine or block the funnel.



 *Please note!*

If you use pre-ground coffee, you can only make one cup of coffee at a time.

1. Press the  button. "Pre-ground" flashes on the display.
2. Make sure the funnel is not blocked, then add one level measure of pre-ground coffee (fig. 17)
3. Place a cup under the coffee spouts.
4. To make espresso coffee, press the 1 cup  button (fig. 2). To make long coffee, press the **LONG** button (fig. 9).
5. Preparation begins. The amount of coffee selected is displayed together with a progress bar which gradually

fills as preparation progresses.

Once the coffee has been made, the appliance prepares for use again.

MAKING FROTHED MILK (FOR CAPPUCCINO) AND HOT MILK

 *Please note!*

A few seconds may elapse between "Energy saving" mode and delivery of the first drink; "Preparation underway..." is displayed.

 *Important! Danger of burns*

During preparation, steam is given off. Take care to avoid scalds.

1. When preparing cappuccino, make the coffee in a large cup;
2. Fill a container with about 100 grams of milk for each cappuccino to be made. In choosing the size of the container, bear in mind that the milk doubles or triples in volume;

 *Please note:*

For a richer denser froth, use skimmed or partially skimmed milk at refrigerator temperature (about 5°C).

To avoid milk with poor froth or large bubbles, always clean the cappuccino maker as described in the section "Cleaning the cappuccino maker after use".

3. Make sure the ring on the cappuccino maker is in the "CAPPUCCINO" position (fig. 18).
4. Press the  button. "Heating up Please wait" is displayed, followed after a few seconds by "TURN STEAM KNOB".
5. Turn the cappuccino maker outwards and immerse it in the milk container (fig. 19). Take care not to immerse the black ring;
6. Turn the steam knob to the I position (fig. 4). Steam is delivered from the cappuccino maker, giving the milk a creamy frothy appearance and making it more voluminous;
7. For a creamier froth, rotate the container with slow movements in an upward direction. (You should not discharge steam for more than 3 minutes at a time);
8. When you have obtained the required froth, stop steam delivery by turning the steam knob back to the 0 position.

 *Important! Danger of burns*

Always turn the steam knob to the 0 position before removing the container with the frothed milk to avoid burns caused by splashes of boiling milk.



- Add the milk froth to the cup of coffee prepared previously. The cappuccino is ready. Sweeten to taste and, if desired, sprinkle the froth with a little cocoa powder.

Making hot milk

To make hot milk without froth, proceed as described in the above section, making sure the ring on the cappuccino maker is positioned upwards in the "HOT MILK" position.

Cleaning the cappuccino maker after use.

Clean the cappuccino maker each time you use it to avoid the build-up of milk residues or blockages.



Important! Danger of burns

When cleaning the cappuccino maker, a little hot water is delivered.

Avoid contact with splashes of water.

- Deliver a little water for a few seconds by rotating the steam knob to the I position. Then turn the steam knob to the 0 position to stop the flow of hot water.
- Wait for a few minutes for the cappuccino maker to cool down, hold the handle of the cappuccino tube in one hand and with the other rotate the cappuccino maker anticlockwise (fig. 20) then remove by pulling downwards.
- Remove the ring upwards (fig. 21).
- Wash all parts of the cappuccino maker thoroughly with warm water.
- Make sure the two holes shown by the arrow in fig. 22 are not blocked. If necessary, clean with a pin.
- Replace the inner section by inserting it carefully onto the adjustable tube, then insert the steam nozzle and turn anticlockwise to lock it in place.

HEATING WATER



Please note:

A few seconds may elapse between "Energy saving" mode and delivery of hot water; "Preparation underway..." is displayed.

Preparation



Important! Danger of burns.

Never leave the machine unsupervised while delivering hot water. The hot water spout becomes hot while water is being delivered and must be handled by the handle only.

- Place a container or cup under the cappuccino maker (as close as possible to avoid splashes) (fig. 4).
- Turn the steam knob to the I position (fig. 4). "Hot water" is displayed and delivery begins.
- Stop by turning the steam knob to the 0 position.

CLEANING



Important!

- Do not use solvents, abrasive detergents or alcohol to clean the appliance. With De'Longhi superautomatic coffee makers, you need not use chemical products to clean the machine.
- None of the components can be washed in a dishwasher.
- Do not use metal objects to remove encrustations or coffee deposits as they could scratch metal or plastic surfaces.

Cleaning the coffee maker

The following parts of the machine must be cleaned regularly:

- coffee grounds container (A18),
- drip tray (A16),
- the inside of the machine, accessible after opening the service door (A19),
- water tank (A13),
- coffee spouts (A20) and hot water nozzle (A11),
- pre-ground coffee funnel (A8),
- infuser (A12)

Cleaning the coffee grounds container

When "EMPTY GROUNDS CONTAINER" is displayed, the grounds container must be emptied and cleaned.

Until the grounds container has been cleaned, the appliance continues to display the message and coffee cannot be made.

Even if not full, the empty grounds container message is displayed 72 hours after the last coffee has been prepared. For the 72 hours to be calculated correctly, the machine must never be turned off with the main switch in the 0 position.

To clean (with the machine on):

- Open the service door on the front of the appliance (fig. 23), extract the drip tray (fig. 24), empty and clean.
- Empty the grounds container and clean thoroughly to remove all residues left on the bottom.



Important!

When removing the drip tray, the grounds container **must** be emptied, even if it contains few grounds.

If this is not done, when you make the next coffees, the grounds container may fill up more than expected and clog the machine.

Cleaning the drip tray



Important!

If the drip tray is not emptied regularly, the water could overflow from the edge and seep inside or around the machine.

This could damage the machine, the surface it rests on or the surrounding area.



The drip tray is fitted with a level indicator (red) showing the level of water it contains (fig. 24).

Before the indicator protrudes from the cup tray, the drip tray must be emptied and cleaned.

To remove the drip tray:

1. Open the service door (fig. 23);
2. Remove the drip tray and the grounds container (fig. 25);
3. Empty the drip tray and grounds container (A18) and wash them;
4. Replace the drip tray complete with grounds container;
5. Close the service door.

Cleaning the inside of the machine



Danger of electric shock!

Before cleaning internal parts, the machine must be turned off (see "Turning off") and unplugged from the mains power supply. Never immerse the coffee maker in water.

1. Check regularly (about every 100 coffees) that the inside of the appliance (accessible after removing the drip tray) is not dirty. If necessary, remove coffee deposits with the brush or a sponge.
2. Remove the residues with a vacuum cleaner (fig. 26).

Cleaning the water tank

1. Clean the water tank (A13) regularly (about once a month) with a damp cloth and a little mild washing up liquid.
2. Clean to remove all washing up liquid residues, then rinse the water tank thoroughly.

Cleaning the coffee spouts

1. Clean the coffee spouts with a sponge or cloth (fig. 27).
2. Check the holes in the coffee spout are not blocked. If necessary, remove coffee deposits with a toothpick (fig. 28).

Cleaning the pre-ground coffee funnel

Check regularly (about once a month) that the pre-ground coffee funnel (A8) is not blocked.

If necessary, remove coffee deposits with a brush.

Cleaning the infuser

The infuser (A12) must be cleaned at least once a month.



Important!

The infuser may not be extracted when the machine is on.

1. Make sure the machine is correctly turned off (see Turning off).
2. Open the service door (fig. 23).
3. Extract the drip tray and the grounds container (fig. 25).
4. Press the two red release buttons inwards and at the same time pull the infuser outwards (fig. 29).



Important!

RINSE WITH WATER ONLY

NO WASHING UP LIQUID - NO DISH WASHER

Do not use washing up liquid to clean the infuser as it could cause damage.

5. Soak the infuser in water for about 5 minutes, then rinse under the tap.
6. After cleaning, replace the infuser by sliding it onto the internal support and pin at the bottom, then push the PUSH symbol fully in until it clicks into place.

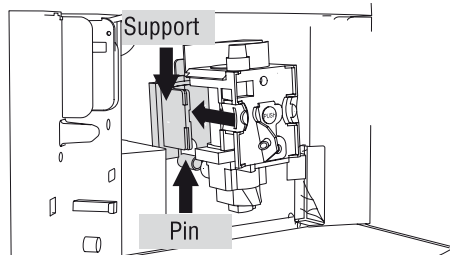

Please note!

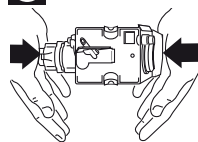

If the infuser is difficult to insert, you must first adapt it to the right dimensions by pressing it forcefully from the bottom and top as shown in the figure.

7. Once inserted, make sure the two red buttons have snapped out.
8. Replace the drip tray and waste coffee container.
9. Close the service door.

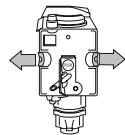

DESCALING

Descal the machine when the message "DESCALE" flashes on the display.



Important!

Descaler contains acids which may irritate the skin and eyes.

It is vital to respect the manufacturer's safety warnings given on the descaler pack and the warnings relating to the procedure to follow in the event of contact with the skin and eyes.



Please note!

Use De'Longhi descaler only. Under no circumstances should you use sulphamic or acetic based descalers. Their use invalidates the guarantee. Failure to descale the appliance as described above also invalidates the guarantee.

1. Accendere la macchina.
2. Press the **MENU** button to enter the settings menu. Press the **<or>** button until "Descale" is displayed;
3. Press the **OK** button. "Descale Confirm?" is displayed. Press **OK** to enable the function.
4. The message "Add descaler Press OK" is displayed.
5. Before confirming, empty the water tank (A13).
Pour the descaler diluted with water (respecting the proportions indicated on the descaler pack) into the water tank and replace the tank in the appliance.
6. Place an empty container with a minimum capacity of 1.5 litres under the hot water spout.



Important! Danger of burns

Hot water containing acid flows out of the hot water spout. Avoid contact with splashes of water.

7. Confirm with the **OK** button.
8. "TURN STEAM KNOB" is displayed.
9. After turning the knob to the **I** position (fig. 4), "Descale Press OK" is displayed.
10. After confirming by pressing **OK**, the message "Descale underway" is displayed.
The descale programme starts and the descaler liquid comes out of the water spout.
The descale programme automatically performs a series of rinses and pauses to remove limescale deposits from inside the machine.

After about 30 minutes, "TURN STEAM KNOB" is displayed. When the steam knob is turned to the 0 position, "Rinsing FILL TANK" is displayed.

11. The appliance is now ready for rinsing through with clean water. Remove the water tank, empty, rinse under running water, fill with clean water and replace. "TURN STEAM KNOB" is displayed. When the steam knob is turned to the **I** position, "Rinsing... Press OK" is displayed.
12. Empty the container used to collect the descaler solution and replace it under the hot water spout.
13. Press the **OK** button to start rinsing. Hot water flows out of the spout and the message "Rinsing... Please wait" is displayed.
14. When the water tank is completely empty, "TURN STEAM KNOB" is displayed.
15. When the steam knob is turned to the 0 position, the appliance goes off.

To use it again, turn the appliance on by pressing the  button.

SETTING WATER HARDNESS

The DESCAL message is displayed after a period of time established according to water hardness.

The machine is set by default for a hardness value of 4 (very hard water).

The machine can also be programmed according to the actual hardness of the mains water in the various regions, varying the frequency with which the message is displayed.

Measuring water hardness

1. Remove the "TOTAL HARDNESS TEST" indicator paper from its pack.
2. Immerse the paper completely in a glass of water for one second.
3. Remove the paper from the water and shake lightly. After about a minute, 1, 2, 3, or 4 red squares form, depending on the hardness of the water. Each square corresponds to one level.

Level 1 - soft water 

Level 2 - slightly hard water 

Level 3 - hard water 

Level 4 - very hard water 

Set water hardness

1. Press the **MENU** button to enter the settings menu.
2. Press the **<or>** button and select "Water hardness".
3. Confirm the selection by pressing the **OK** button.
4. Press the **<or>** button to set the water hardness identified using the indicator paper (see figure in the previous section).
5. Press the **OK** button to confirm the setting.
6. Press the **ESC** button to exit the menu.

The machine is now reprogrammed with the new water hardness setting.

TECHNICAL SPECIFICATION

Voltage:	220-240 V~ 50/60 Hz max. 10A
Absorbed power:	1350W
Pressure:	15 bar
Water tank capacity:	1,7l
Size: LxHxD:	282x374x441 mm
Cable length:	1,5 m
Weight:	11,4 Kg
Max. beans container capacity	250 g

CE The appliance complies with the following EC directives:

- Stand-by Directive no. 1275/2008
- Low Voltage Directive 2006/95/EC and subsequent amendments;
- EMC Directive 2004/108/EC and subsequent amendments
- Materials and accessories coming into contact with food conform to the provisions of EC regulation 1935/2004.

DISPOSAL



Important information for correct disposal of the product in accordance with EC Directive 2002/96/EC. At the end of its working life, the product must not be disposed of as urban waste. It must be taken to a special local authority differentiated waste collection centre or to a dealer providing this service. Disposing of a household appliance separately avoids possible negative consequences for the environment and health deriving from inappropriate disposal and enables the constituent materials to be recovered to obtain significant savings in energy and resources. As a reminder of the need to dispose of household appliances separately, the product is marked with a crossed-out wheeled dustbin.

DISPLAYED MESSAGES

DISPLAYED MESSAGE	POSSIBLE CAUSE	REMEDY
FILL TANK!	Insufficient water in the tank.	Fill the tank with water and/or insert it correctly, pushing it as far as it will go until it clicks into place.
GROUND TOO FINE ADJUST MILL! Turn steam knob	The grinding is too fine and the coffee is delivered too slowly or not at all.	When the steam knob has been turned to the I position as requested by the appliance, press the OK button and deliver water from the spout until the water flow is regular. Stop the water flow and repeat coffee delivery, turning the grinding adjustment knob one click clockwise towards "7" while the coffee mill is in operation. If after making at least 2 coffees delivery is still too slow, repeat the correction procedure, turning the Grinding adjustment knob another click until delivery is correct.
EMPTY GROUNDS CONTAINER	The grounds container is too full or more than 3 days have passed since you last made coffee (this guarantees correct hygiene of the machine).	Empty the grounds container and clean, then replace. Important: when removing the drip tray, the grounds container MUST be emptied, even if it contains few grounds. If this is not done, when you make the next coffees, the grounds container may fill up more than expected and clog the machine.
INSERT GROUNDS CONTAINER	After cleaning, the grounds container has not been replaced.	Open the service door, remove the drip tray and insert the grounds container.
ADD PRE-GROUND COFFEE	The "pre-ground coffee" function has been selected without placing any pre-ground coffee in the funnel.	Place pre-ground coffee in the funnel or deselect the "pre-ground" function.
DESCALE!	The machine must be descaled.	The descaling procedure described in the "Descaling" section needs to be performed as soon as possible.
LESS COFFEE!	Too much coffee has been used.	Select a milder taste or reduce the quantity of pre-ground coffee.
FILL BEANS CONTAINER!	The coffee beans have run out.	Fill the beans container
	The pre-ground coffee funnel is clogged.	Empty the funnel with the help of a knife, as described in the section "Cleaning the pre-ground coffee funnel".
INSERT INFUSER ASSEMBLY!	The infuser has not been replaced after cleaning.	Insert the infuser as described in the paragraph "Cleaning the infuser".
CLOSE DOOR!	The service door is open.	Close the service door.
ADD PRE-GROUND COFFEE	The "pre-ground coffee" function has been selected without placing any pre-ground coffee in the funnel.	Place pre-ground coffee in the funnel.
	The funnel (A8) is blocked.	Empty the funnel with the help of a knife, as described in the section "Cleaning the pre-ground coffee funnel".
ADD PRE-GROUND COFFEE Press OK	A LONG coffee of more than 125 ml has been made with pre-ground coffee.	Add pre-ground coffee and press OK.
Energy Saving	The function is active and reduces electricity consumption.	Disable the function from the menu (See section "Energy Saving").
GENERAL ALARM!	The inside of the appliance is very dirty.	Clean the inside of the appliance thoroughly, as described in the section "Cleaning and maintenance". If the message is still displayed after cleaning, contact a service centre.

TROUBLESHOOTING

Below is a list of some of the possible malfunctions.
If the problem cannot be resolved as described, contact Customer Services.

PROBLEM	POSSIBLE CAUSE	REMEDY
The coffee is not hot	The cups were not preheated.	Enable the cup warmer, leave the cups at least 20 minutes to warm up. Warm the cups by rinsing them with hot water (using the hot water function).
	The infuser has cooled down because 2/3 minutes have elapsed since the last coffee was made.	Before making the coffee, heat the infuser by pressing the  button (see the sections "Tips for a hotter coffee").
	A low coffee temperature is set.	Set a high coffee temperature in the menu.
The coffee is not creamy enough.	The coffee is ground too coarsely.	Turn the grinding adjustment knob one click anticlockwise towards "1" while the coffee mill is in operation (fig. 8). Continue one click at a time until coffee delivery is satisfactory. The effect is only visible after delivering 2 coffees.
	Wrong type of coffee	Use a type of coffee for espresso coffee makers.
The coffee is delivered too slowly or a drop at a time.	The coffee is ground too finely.	Turn the grinding adjustment knob one click clockwise towards "7" while the coffee mill is in operation (fig. 11). Continue one click at a time until coffee delivery is satisfactory. The effect is only visible after delivering 2 coffees.
The coffee does not come out of the spouts, but from around the service door.	The holes in the spouts are clogged with dry coffee dust.	Clean the spouts with a toothpick, sponge or hard bristled kitchen brush.
	The coffee guide inside the service door is blocked and cannot swing.	Thoroughly clean the coffee guide, particularly near the hinges.
The coffee is delivered too quickly.	The coffee is ground too coarsely.	Turn the grinding adjustment knob one click anticlockwise towards "1" while the coffee mill is in operation (fig. 11). Avoid turning the grinding adjustment knob excessively otherwise when you select two cups, the coffee may be delivered a drop at a time.
Coffee does not come out of one of the spouts.	The spouts are blocked.	Clean the spouts with a toothpick (fig. 40).
Water comes out of the spouts instead of coffee.	The pre-ground coffee may be blocked in the funnel (A8).	Empty the funnel with the help of a knife, as described in the section "Cleaning the pre-ground coffee funnel".
The milk is not frothed.	The milk is not cold enough or is not semi-skimmed.	You should ideally use skimmed or semi-skimmed milk at refrigerator temperature (about 5°C). If the result is not as you wished, try changing brand of milk.
	The ring is not in the "CAPPUCCINO" position.	Push the ring downwards.
The appliance does not come on.	It is not plugged into the mains socket.	Plug into the mains socket.
	The main switch is not turned on.	Place the main switch in the I position (fig. 29).
The LONG coffee has too much froth	The coffee is ground too finely.	Turn the Grinding adjustment knob one click clockwise towards "7" while the coffee mill is in operation (fig. 11). Continue one click at a time until coffee delivery is satisfactory. The effect is only visible after delivering 2 coffees.

Free Manuals Download Website

<http://myh66.com>

<http://usermanuals.us>

<http://www.somanuals.com>

<http://www.4manuals.cc>

<http://www.manual-lib.com>

<http://www.404manual.com>

<http://www.luxmanual.com>

<http://aubethermostatmanual.com>

Golf course search by state

<http://golfingnear.com>

Email search by domain

<http://emailbydomain.com>

Auto manuals search

<http://auto.somanuals.com>

TV manuals search

<http://tv.somanuals.com>