

instructions

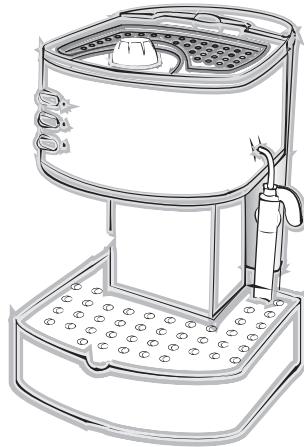

Coffee Maker EC330

Please retain these instructions for future reference



Living innovation

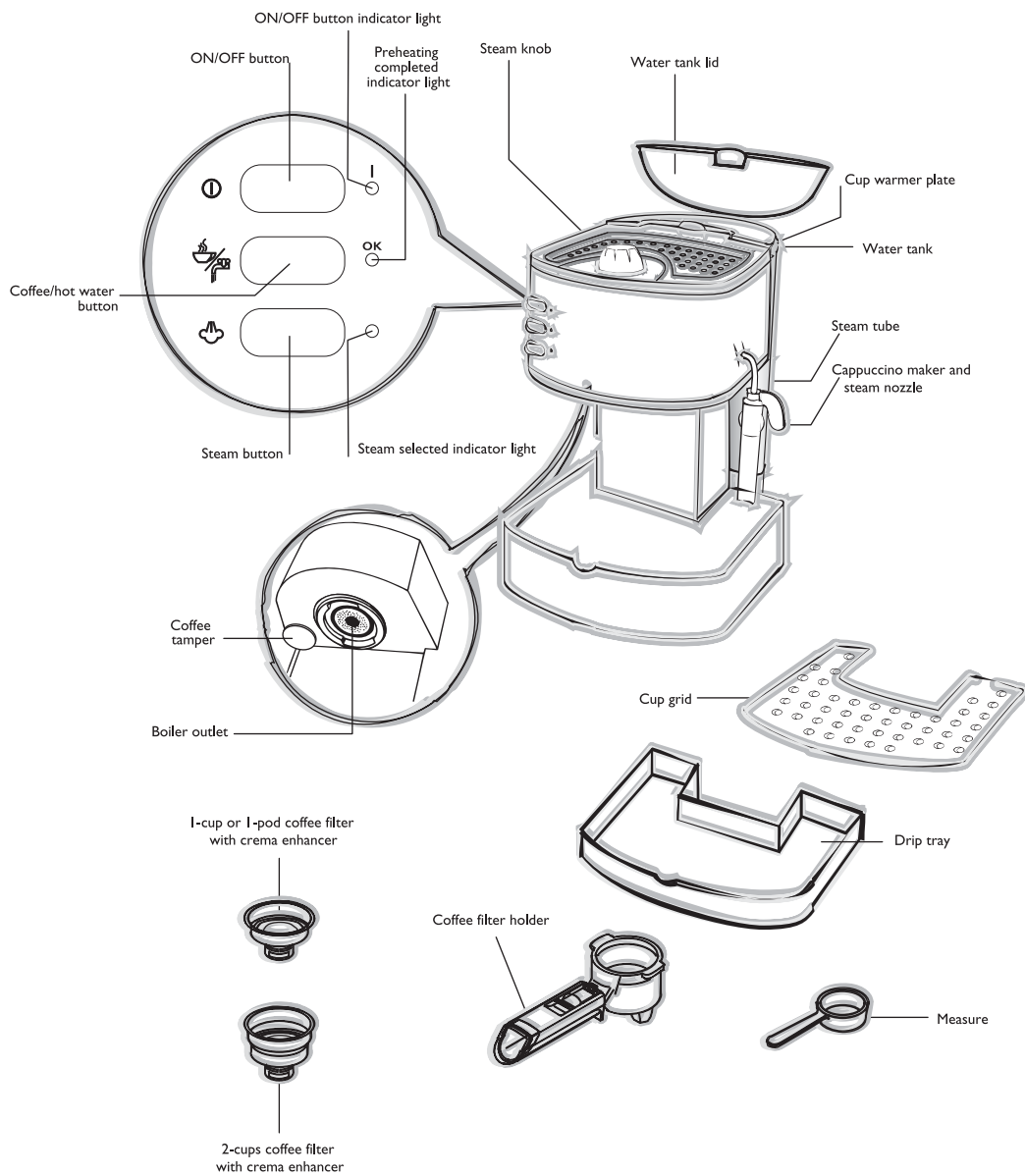

Thank you for choosing this coffee machine. To get the very best out of your new coffee machine it is advisable to read these instructions before using the appliance. This is the only way to ensure optimum results and maximum safety.

Using for the first time

Before using the machine for the first time, wash all the accessories in warm soapy water and rinse. For the best tasting coffee the internal circuits must be flushed through at least five times. To do this follow the instructions in the paragraph "How to prepare espresso coffee" using just water.

Installation

- Place the coffee maker on flat work surface at a safe distance from taps and sinks.
- Check that the voltage corresponds to that indicated on the appliance rating plate. The appliance must always be connected to a well-earthed socket rated at 10A minimum. The manufacturer is not liable for damage caused by inadequate earthing of the appliance.
- In the event of incompatibility between the plug on the appliance and the socket, have the plug replaced by a qualified professional.
If the cable is damaged or requires replacing, contact a service centre authorised by the manufacturer only.
- Never install the machine in an environment that can reach a temperature less than or equal to 0°C (if the water in it freezes, the coffee maker may be damaged).

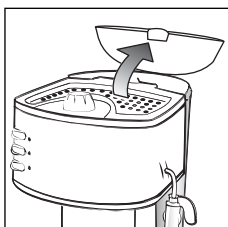

fig. 1

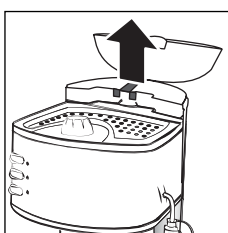

fig. 2

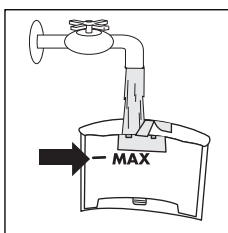

fig. 3

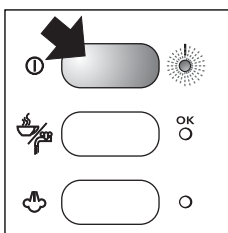

fig. 4

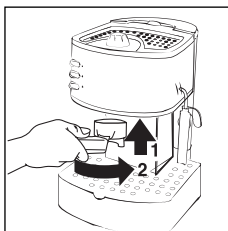

fig. 5

How to prepare espresso coffee

Filling the water tank

To remove the water tank lift the lid (fig.1) and simply pull upwards (fig 2) and fill the tank at the sink (fig 3). Do not exceed the MAX level on the water tank. The tank may also be filled without removing it, simply by pouring water into it directly from a jug. Replace the tank by connecting the valve at the bottom of the tank with the hole in the base on the machine.

WARNING: it is completely normal for there to be water in the compartment under the tank; as a result, this compartment should be dried using a clean sponge.

Note: Do not operate the appliance without water in the tank and always remember to fill the tank when the level drops to a couple of centimetres from the bottom.

Preheating the coffee machine

To ensure your espresso coffee is dispensed at the right temperature it is essential that the coffee unit is preheated.

1. Press the ON/OFF button (fig. 4).
2. Attach the empty filter holder (without coffee) to the machine by positioning it under the boiler outlet with the handle towards the left (fig. 5). Push upwards and at the same time turn the handle as far right as possible. It does not matter if the handle is not centrally aligned with the machine, as long as the filter holder is firmly attached to the appliance.
3. Position a cup under the filter holder. Use the same cup that the coffee will be served in, so that it may be preheated. Wait until the "OK" light comes on (fig. 6), then immediately press the coffee knob (fig. 7). Allow the water to run until the OK indicator light goes out, then stop the water by pressing the coffee button again (fig. 7).
4. Empty the cup, wait until the "OK" pilot light comes on again and repeat the whole operation one more time.
(It is normal for a small and harmless puff of steam to be given off when removing the filter holder).

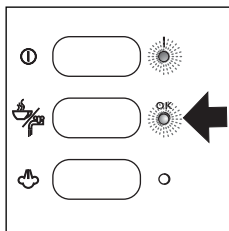

fig. 6

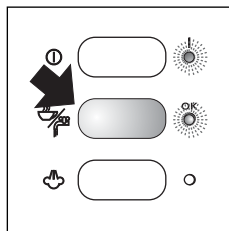

fig. 7

How to prepare espresso coffee

1. After carrying out the preheating of the machine as described in the preceding section, in order to make just one cup of espresso coffee, insert the 1-cup filter (the smaller of the two provided) into the filter holder (Fig. 8) and fill it with one level measuring spoon of ground coffee (fig. 9) – about 7 grams. If you wish to prepare two cups of espresso coffee, use the 2-cup filter (the larger of the two provided) and fill it with two less-than-level measuring spoons of ground coffee (about 6+6 grams).

IMPORTANT: for correct operation, before adding the ground coffee to the filter holder, make sure the filter is free from ground coffee from the previous infusion.

2. Distribute the ground coffee evenly and press it lightly with the coffee tamper (Fig. 10).
NOTE: Pressing the coffee is very important in order to prepare a good coffee. However if you press too hard, coffee will come out slowly and crema will be of a dark colour. If you press too light, coffee will come out too fast and crema will be a very light colour.
3. Remove any excess coffee from the rim of the filter holder. Attach the filter holder to the machine by positioning the handle to the left of the boiler outlet, then pushing upwards and turning the handle to the right (as in preheating the machine fig. 5).
4. Place the cup or cups (cups can be preheated by rinsing under hot water or heating on the cup warmer plate for 10 minutes) on the removable drip tray (fig 11). Ensure that the cup or cups line up with the dispensing holes on the filter holder. Press the on/off button (fig. 4).
5. Wait until the “OK” light comes on (fig 6) then press the coffee button (fig. 7). Once the required quantity of coffee has been obtained, interrupt delivery by pressing the same button again (fig. 7).
6. To detach the filter holder, turn the handle from right to left. **To avoid any splashing, do not detach the filter holder while the machine is dispensing coffee.**
7. To remove the used coffee lock the filter with the built-in lever and let the coffee fall out by knocking the over turned filter holder (fig. 12).
8. To turn the coffee machine off, press the ON/OFF button (fig. 4).

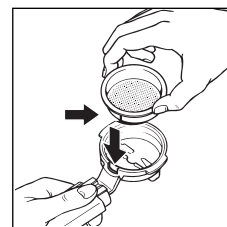

fig. 8

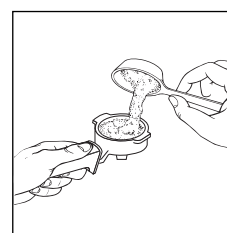

fig. 9

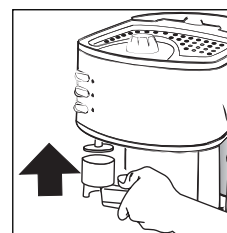

fig. 10

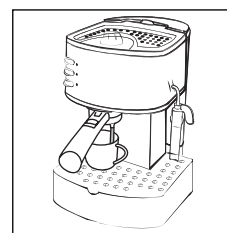

fig. 11

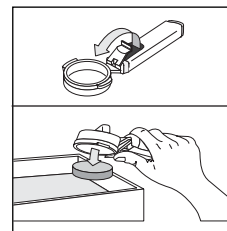

fig. 12



fig. 13

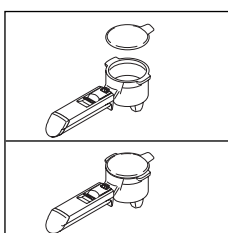

fig. 14

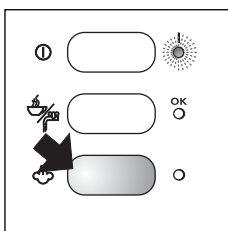

fig. 15

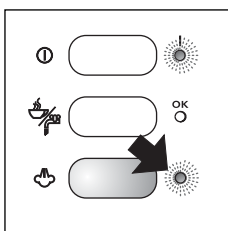

fig. 16

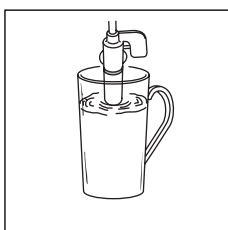

fig. 17

How to prepare coffee using pods

1. Preheat the machine as described in the 'Preheating the Coffee Machine' section, attaching the coffee filter holder with 1 cup or pod filter to the unit. This procedure ensures that the coffee is delivered at a hotter temperature and that the seal of the holder is more effective.

Note: Use pods which conform to the ESE standard: this will be indicated on the packaging by the symbol as in fig. 13.

The ESE standard is a system accepted by the leading coffee pod manufacturers, and allows espresso coffee to be prepared simply and without any mess.

2. Place the small filter (1 cup or pods) in the filter holder, making sure the projection is correctly inserted in the slot as shown in fig. 8.
3. Insert a pod, centring it as far as possible on the filter (fig. 14). Always follow the instructions on the pod pack to position the pod on the filter correctly.
4. Attach the filter holder onto the machine, moving from left to right (fig 5).
5. Proceed as in points 4, 5 and 6 of the previous section (how to prepare espresso coffee using the filter holder for ground coffee).

Important: should the coffee holder for pods be used after one for ground coffee, it's necessary to clear the ground coffee remaining in the boiler outlet. This cleaning operation is necessary in order to avoid water leakages.

How to make cappuccino

1. Prepare espresso coffee, using cups that are large enough for cappuccinos
2. Press the steam button (fig. 15) and wait for the steam indicator light to come on (fig. 16). The OK indicator light indicates that the boiler has reached the ideal temperature for steam production.
3. In the meantime, fill a container with about 100 grams of milk for each cappuccino to be prepared. Ideally use a small stainless steel jug. The milk must be at refrigerator temperature (not hot!). In choosing the size of the container, bear in mind that the milk increases in volume by 2 or 3 times. **NB: YOU ARE RECOMMENDED TO USE SEMI-SKIMMED MILK AT REFRIGERATOR TEMPERATURE.**
4. Place the container with the milk under the cappuccino maker.
5. Dip the cappuccino maker into the milk (fig. 17), taking care not to immerse the raised line on the cappuccino maker (indicated by the arrow in fig. 18).

Turn the steam knob at least a half turn anticlockwise (fig. 19). Steam is given off by the cappuccino maker, giving the milk a creamy frothy appearance. To obtain a creamier froth, dip the cappuccino maker into the milk and rotate the container with slow movements from the bottom upwards.

6. When the required temperature is reached, interrupt steam delivery by rotating the steam knob clockwise. Then press the steam button (fig. 15).
8. Pour the frothed milk into the cups containing the espresso coffee. Your cappuccino is now ready. If desired, add sugar and sprinkle a little powdered chocolate or cinnamon on top of the froth.

Note: to prepare more than one cappuccino, first make all the coffees then at the end prepare the frothed milk for all the cappuccinos.

IMPORTANT: to ensure hygiene, you are recommended to follow this procedure each time you make cappuccino to avoid milk stagnating in the milk circuit.

1. Discharge a little steam for a few seconds by rotating the steam knob (fig. 19). This empties any milk left inside the steam tube.
2. With one hand, hold the cappuccino tube firmly and with the other unscrew the cappuccino maker itself by rotating clockwise and extracting downwards (fig. 20).
3. Remove the nozzle from the steam tube by pulling it downwards (fig. 21). **Note: Metal of steam pipe may be hot!!!**
4. Wash the cappuccino maker and steam nozzle thoroughly with warm water.
5. Make sure the two holes indicated by the arrows in fig. 22 are not blocked. If necessary, clean with a pin.
6. Replace the steam nozzle by inserting it onto the steam tube and rotating firmly towards the top of the tube.
7. Replace the cappuccino maker by inserting it and rotating anticlockwise.

Producing hot water

1. Turn the appliance on by pressing the ON/OFF button (fig. 4). Wait until the OK indicator light comes on (fig. 6).
2. Place a container under the cappuccino maker.
3. Press the coffee button (fig. 7) and at the same time open the steam knob. Hot water is delivered from the cappuccino maker.
4. To interrupt the flow of hot water, close the steam knob by rotating clockwise and press the coffee button again.

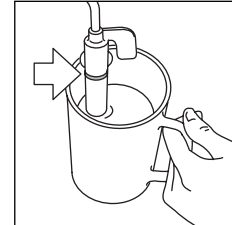

fig. 18

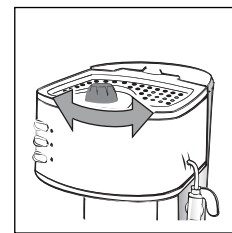

fig. 19

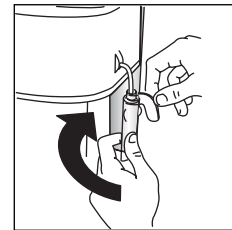

fig. 20

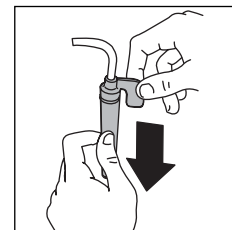

fig. 21

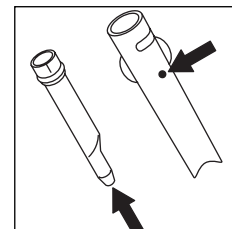

fig. 22

Coffee Maker **Daltonghi**
Living innovation

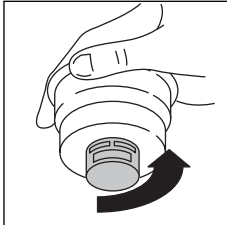

fig. 23

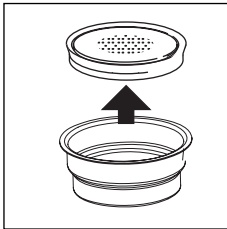

fig. 24

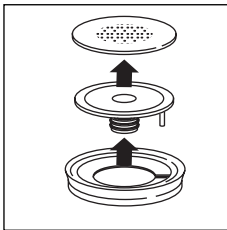

fig. 25

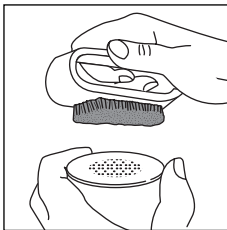

fig. 26

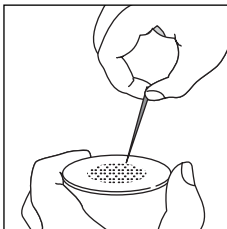

fig. 27

Cleaning and maintenance

Before performing any cleaning or maintenance operations, turn the machine off, unplug it from the power socket and allow it to cool down.

Cleaning the filter holder

About every 200 coffees, clean the filter holder of ground coffee as follows:

- Remove the filter with crema enhancer
- Clean the inside of the filter holder. Never wash in a dishwasher.
- Remove the crema enhancer cup (fig. 23) by unscrewing in the direction indicated by the arrow on the cap.
- Remove the crema enhancer from the container by pushing it from the cap end (fig. 24).
- Remove the gasket (fig. 25).
- Rinse all components and clean the metal filter thoroughly in hot water using a brush (fig. 26). Make sure the holes in the metal filter are not blocked. If necessary, clean with a pin (see fig. 27) or, preferably, by burning the particles obstructing the holes over a flame (TAKE CARE TO AVOID BURNS).
- Replace the filter and gasket on the plastic disk as shown in fig. 28. Make sure to insert the pin on the plastic disk into the hole in the gasket indicated by the arrow in fig. 28.
- Replace the assembly in the steel filter container (fig. 29), making sure the pin is inserted in the hole in the support (see arrow in fig. 29).
- Finally, screw on the cap.

Failure to clean as described above invalidates the guarantee.

Cleaning the boiler outlet

About every 200 coffees, the espresso boiler outlet must be cleaned as follows:

- Make sure the appliance is not hot and that it is unplugged from the mains;
- Using a screwdriver, unscrew the screw fixing the espresso boiler outlet (fig. 30);
- Clean the boiler with a damp cloth;
- Clean the outlet thoroughly in hot water using a brush. Make sure the holes are not blocked. If necessary, clean with a pin (fig. 27).
- Rinse under running water, rubbing all the time.

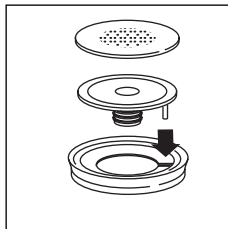

fig. 28

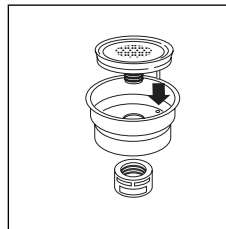

fig. 29

- Replace the espresso boiler outlet, making sure the gasket is correctly positioned.

Failure to clean as described above invalidates the guarantee.

Other cleaning operations

1. Do not use solvents or detergents when cleaning the coffee maker. Use a soft, damp cloth.
2. Remove the drip-trays, empty them and wash them periodically

ATTENTION: during cleaning, never immerse the unit in water – it is an electrical appliance.

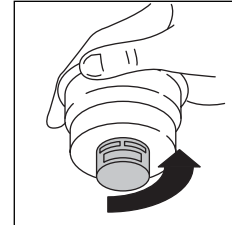

fig. 30

Descaling

It is advisable to clean the calcium from the machine every 200 cups of coffee. It is recommended that specific (store-bought) products for descaling of espresso coffee machines be used. If such products are not available, it is possible to proceed as follows:

1. Fill the tank with water using 1 litre of water;
2. Dissolve 2 spoonfuls (about 30 grams) of citric acid in the water (available from chemists);
3. Press the ON/OFF button (fig. 4) and wait for the OK indicator light to come on.
4. Make sure the filter holder is not attached and position a container under the outlet.
5. Press the coffee button, half empty the tank and every now and then rotate the steam knob to allow a little of the solution to run off. Then switch off by pressing the button again.
6. Leave the solution to work for about 15 minutes, then run off the rest of the water in the tank.
7. To eliminate residues of the solution and scale, rinse the tank well, fill with clean water and replace in its housing. Press the coffee button and operate the appliance until the tank is completely empty;
8. Press the button again and repeat the last operation.

Repairs for malfunctioning caused by problems of calcium build-up are not covered by the guarantee if the descaling process described above is not carried out regularly.

Problem solving

PROBLEM	POSSIBLE CAUSES	SOLUTION
<i>Espresso coffee no longer comes out.</i>	<ul style="list-style-type: none"> • Lack of water in the tank. • The holes in the filter holder are blocked. • The outlet of the espresso boiler is blocked. • The tank is badly inserted and the valve at the bottom is not open. 	<ul style="list-style-type: none"> • Fill the water tank. • Clean the holes in the spouts. • Clean as indicated in the "Cleaning the espresso boiler outlet" section. • Press the tank lightly so as to open the valve at the bottom.
<i>Espresso coffee drips from the edges of the filter holder, instead of from its holes.</i>	<ul style="list-style-type: none"> • The filter holder is badly inserted. • The gasket of the espresso boiler has lost elasticity. • The holes in the filter holder are blocked. 	<ul style="list-style-type: none"> • Attach the filter holder correctly by rotating firmly as far as it will go. • Have the espresso boiler gasket replaced at an Service Centre • Clean the holes in the filter holder.
<i>The espresso coffee is cold.</i>	<ul style="list-style-type: none"> • The 'OK' pilot light was not on when the coffee delivery switch was pressed. • The preheating was not carried out. • The cups were not preheated. 	<ul style="list-style-type: none"> • Wait until the OK pilot light comes on. • Carry out the preheating as indicated in the "Preheating the coffee unit" section. • Preheat the cups by rinsing them in hot water.
<i>The pump is too noisy.</i>	<ul style="list-style-type: none"> • The water tank is empty. • The tank is inserted wrongly and the valve at the bottom is not open. 	<ul style="list-style-type: none"> • Fill the water tank • Press the tank lightly to open the valve at the bottom.
<i>The coffee crema is light-coloured (the coffee comes out quickly from the spout).</i>	<ul style="list-style-type: none"> • The ground coffee has not been pressed enough. • The quantity of ground coffee is scarce. • The coffee is not ground finely enough. 	<ul style="list-style-type: none"> • Tamp the ground coffee down more. • Increase the quantity of coffee. • Only use coffee specifically ground for espresso coffee machines.

PROBLEM	POSSIBLE CAUSES	SOLUTION
<i>The coffee crema is dark (the coffee comes out slowly from the spout).</i>	<ul style="list-style-type: none"> The ground coffee is too tightly pressed. The quantity of ground coffee is too much. The espresso boiler outlet is blocked. The coffee is too finely ground. 	<ul style="list-style-type: none"> Press the coffee less. Decrease the quantity of ground coffee. Clean the outlet as described in "Cleaning the espresso boiler outlet" section. Only use coffee specifically ground for espresso coffee machines.
<i>The coffee has an acidic taste.</i>	<ul style="list-style-type: none"> The unit was not sufficiently rinsed after the descaling process procedure. 	<ul style="list-style-type: none"> Rinse the unit as described in the "descaling" section.
<i>The milk does not froth when making a cappuccino.</i>	<ul style="list-style-type: none"> The milk is not cold enough. The cappuccino maker is dirty. 	<ul style="list-style-type: none"> Always use milk at refrigerator temperature. Carefully clean the pinholes in the milk frother.

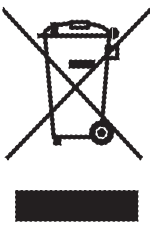

Important information for correct disposal of the product in accordance with EC Directive 2002/96/EC.

At the end of its working life, the product must not be disposed of as urban waste.

It must be taken to a special local authority differentiated waste collection centre or to a dealer providing this service.

Disposing of a household appliance separately avoids possible negative consequences for the environment and health deriving from inappropriate disposal and enables the constituent materials to be recovered to obtain significant savings in energy and resources. As a reminder of the need to dispose of household appliances separately, the product is marked with a crossed-out wheeled dustbin.

Safety Warnings

- This machine has been built to make coffee and to reheat beverages; please be careful to avoid burns from the sprays of hot water or steam and avoid any improper use.
- When the appliance is in use, do not touch any of the machine's hot surfaces.
- After unpacking, make sure that the machine is complete and undamaged. In case of doubt, do not use the appliance and seek the advice of a qualified service professional.
- Packaging materials (plastic bags, foam polystyrene, etc.) should not be left within the reach of children as this could be a potential source of danger.
- This appliance is to be utilised for domestic use only. Any other use is to be considered improper and therefore, dangerous.
- The manufacturer takes no responsibility for damage derived from improper use.
- Never touch the appliance with wet or damp hands.
- The appliance is not intended for use by persons (including children) with reduced physical, sensory or mental capabilities, or lack of experience and knowledge, unless they have been given supervision or instruction concerning use of the appliance by a person responsible for their safety. Children should be supervised to ensure that they do not play with the appliance.
- In case of breakdown or malfunctioning, turn the appliance off immediately and do not touch. For repairs, please contact a Service Centre authorized by the manufacturer and request the use of original replacement parts only. The lack of respect for this point may compromise the safe use of the appliance.
- The power cable must never be replaced by the user. If the cable should become damaged, or needs to be replaced, please contact a Service Centre authorized by the manufacturer.
- When the appliance is not in use, turn off and disconnect the plug from the socket.
- As with any electrical appliance, whilst the instructions aim to cover as many eventualities as possible, caution and common sense should be applied when operating your appliance, particularly in the vicinity of young children.
- Materials and accessories coming into contact with food conform to EC regulation 1935/2004.

Electrical requirements

Before using this appliance ensure that the voltage indicated on the product corresponds with the main voltage in your home, if you are in any doubt about your supply contact your local electricity company.

The flexible mains lead is supplied connected to a B.S. 1363 fused plug having a fuse of 13 amp capacity. Should this plug not fit the socket outlets in your home, it should be cut off and replaced with a suitable plug, following the procedure outlined below.

Note: Such a plug cannot be used for any other appliance and should therefore be properly disposed of and not left where children might find it and plug it into a supply socket - with the obvious consequent danger.

N.B. We recommend the use of good quality plugs and wall sockets that can be switched off when the machine is not in use.

important: the wires in the mains lead fitted to this appliance are coloured in accordance with the following code:

GREEN AND YELLOW	EARTH
BLUE	NEUTRAL
BROWN	LIVE

As the colours of the wires in the mains lead of this appliance may not correspond with the coloured markings identifying the terminals in your plug, proceed as follows:

The wire which is coloured green and yellow must be connected to the terminal in the plug which is marked with the letter E or by the earth symbol  or coloured green or green and yellow.

The wire which is coloured blue must be connected to the terminal which is marked with the letter N or coloured black.

The wire which is coloured brown must be connected to the terminal which is marked with the letter L or coloured red.

When wiring the plug, ensure that all strands of wire are securely retained in each terminal. Do not forget to tighten the mains lead clamp on the plug. If your electricity supply point has only two pin socket outlets, or if you are in doubt, consult a qualified electrician.

Should the mains lead ever require replacement, it is essential that this operation be carried out by a qualified electrician and should only be replaced with a flexible cord of the same size.

After replacement of a fuse in the plug, the fuse cover must be refitted. If the fuse cover is lost, the plug must not be used until a replacement cover is obtained. The colour of the correct replacement fuse cover is that of the coloured insert in the base of the fuse recess or elsewhere on the plug. Always state this colour when ordering a replacement fuse cover.

Only 13amp replacement fuses which are approved to B.S. 1362 should be fitted.

This appliance conforms to the Norms EN 55014 regarding the suppression of radio interference.

Warning - this appliance must be earthed

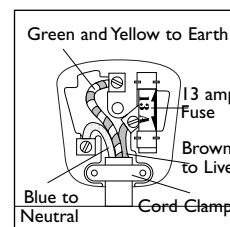



De'Longhi S.p.A.

Via Seitz, 47
31100 TREVISO
Italy

5732153800/01.07

Free Manuals Download Website

<http://myh66.com>

<http://usermanuals.us>

<http://www.somanuals.com>

<http://www.4manuals.cc>

<http://www.manual-lib.com>

<http://www.404manual.com>

<http://www.luxmanual.com>

<http://aubethermostatmanual.com>

Golf course search by state

<http://golfingnear.com>

Email search by domain

<http://emailbydomain.com>

Auto manuals search

<http://auto.somanuals.com>

TV manuals search

<http://tv.somanuals.com>