



De'Longhi Appliances
via Seitz, 47
31100 Treviso Italia

BEAN TO CUP ESPRESSO AND CAPPUCCINO MACHINE

Instruction for use



ETAM36.365

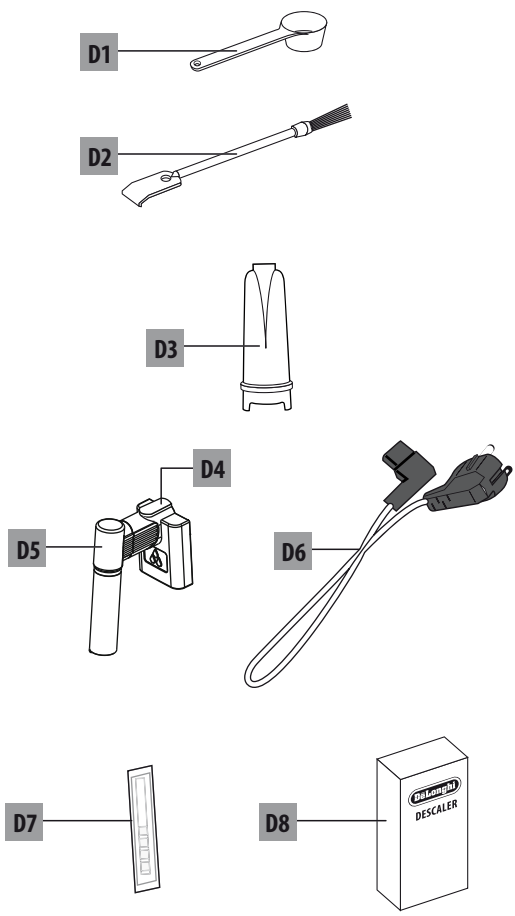
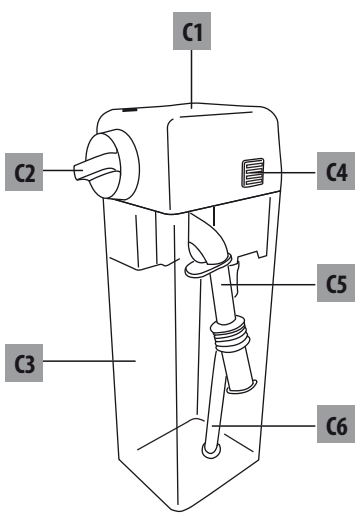
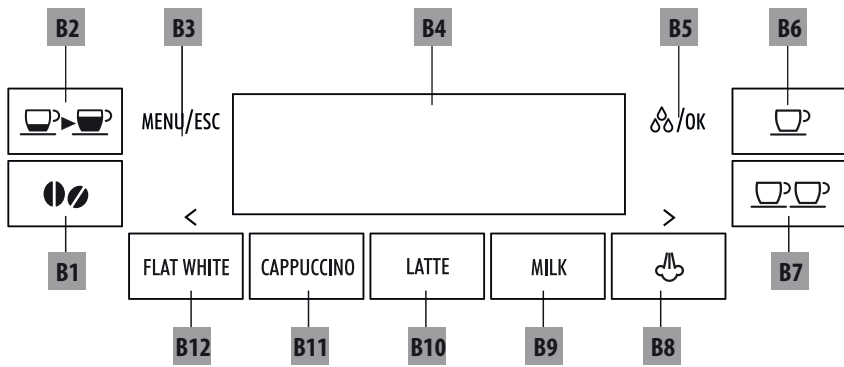

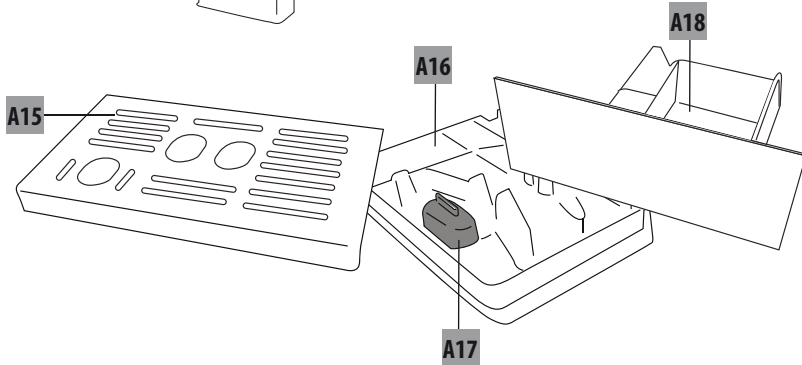
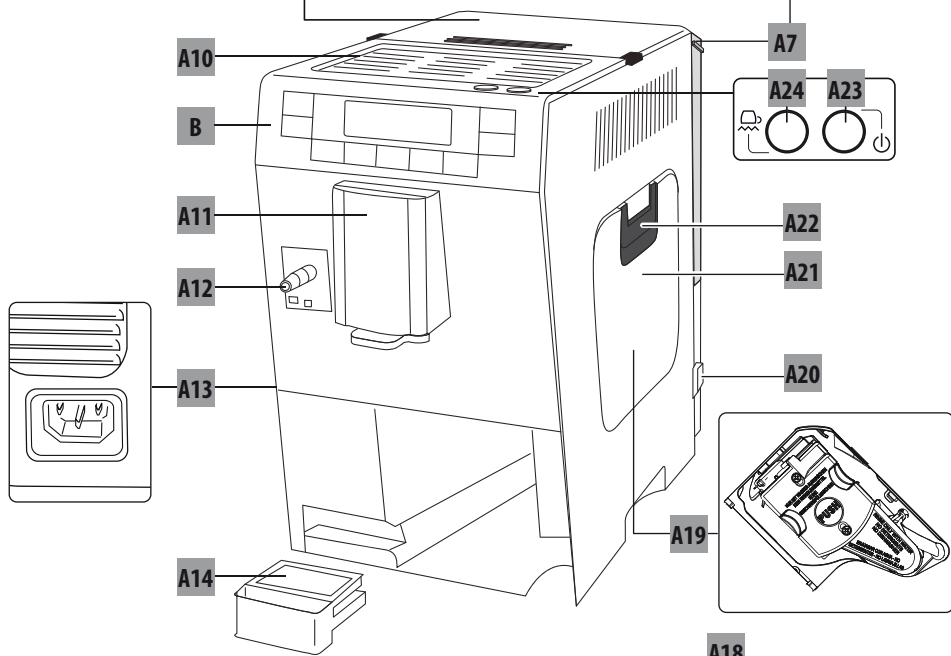
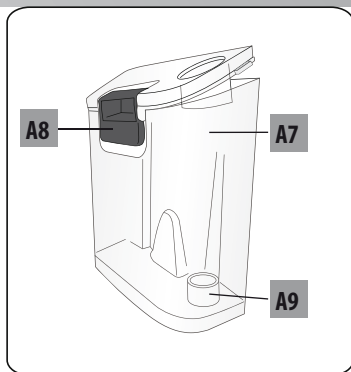
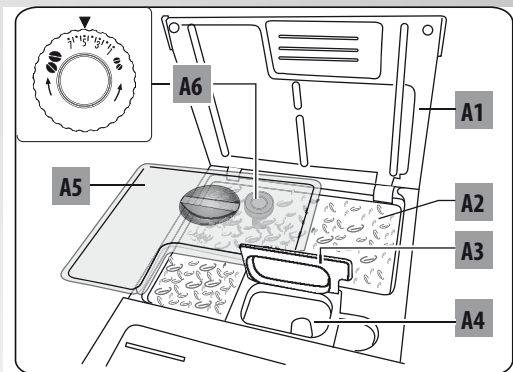

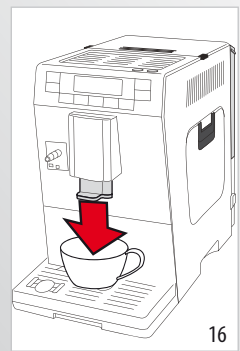
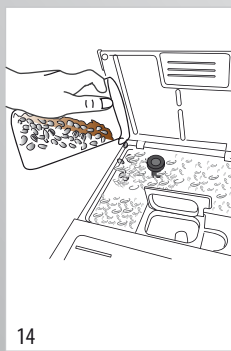
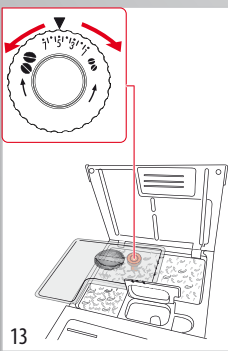
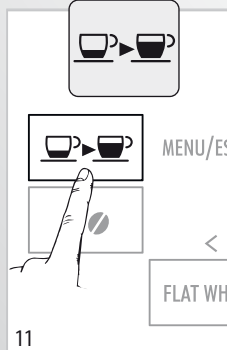
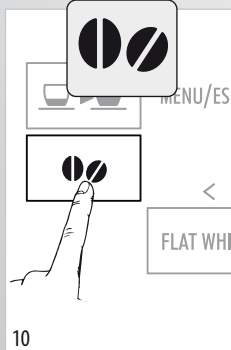
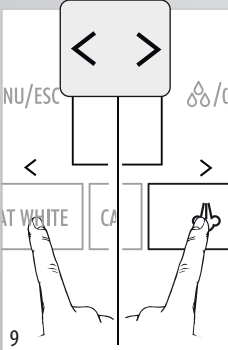
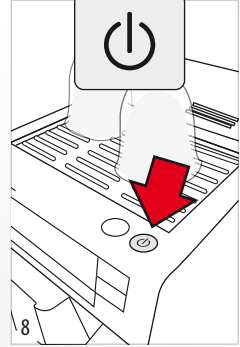
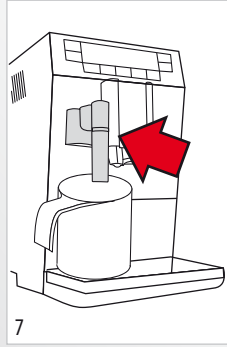
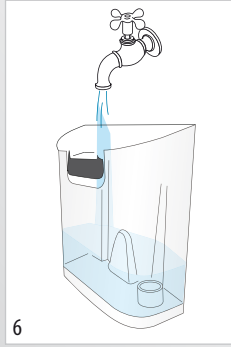
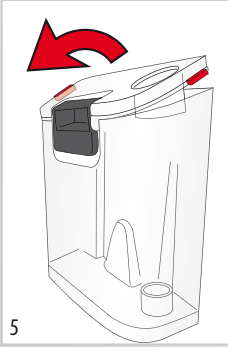
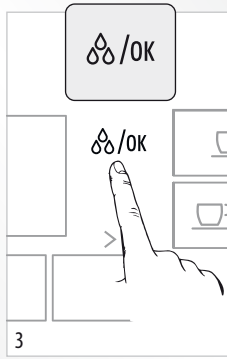
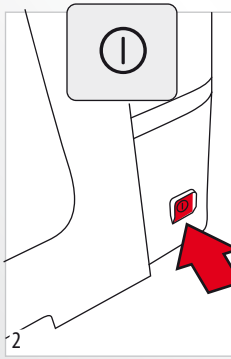
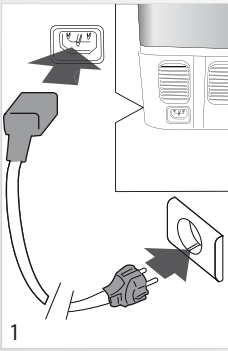

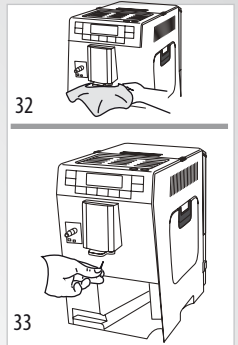
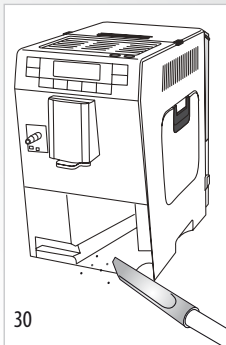
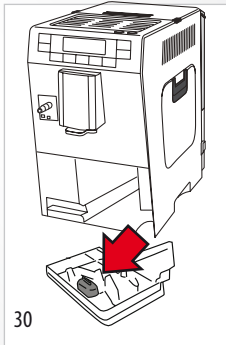
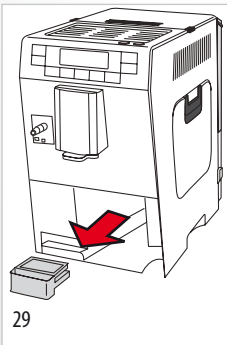
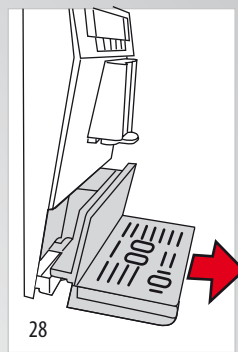
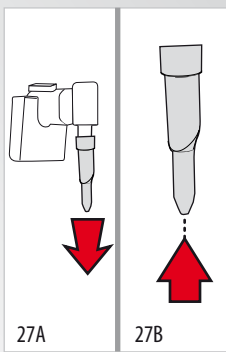
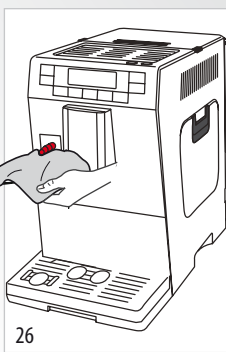
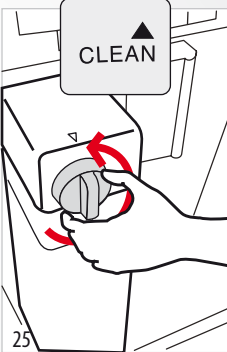
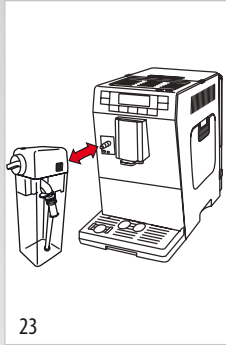
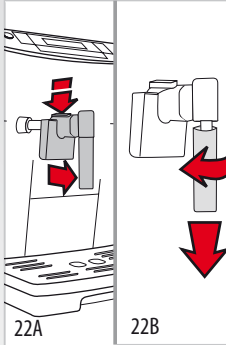
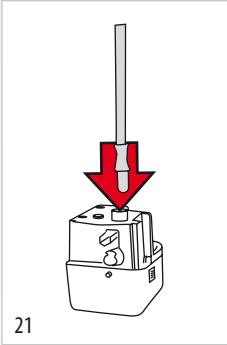
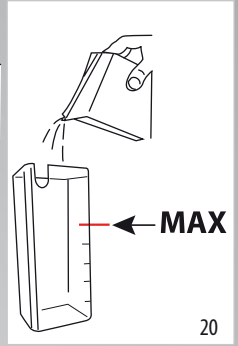
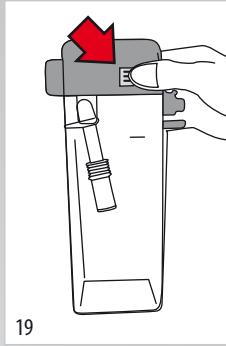
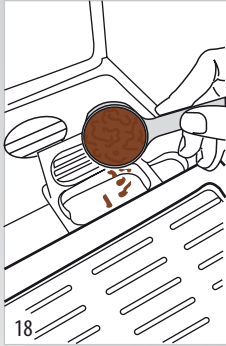
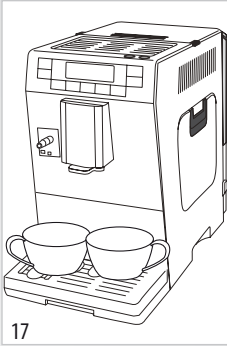

CONTENTS

TECHNICAL DATA	6
DISPOSAL	6
INTRODUCTION	7
Symbols used in these instructions.....	7
Letters in brackets.....	7
Troubleshooting and repairs.....	7
SAFETY	7
Fundamental safety warnings.....	7
DESIGNATED USE	7
INSTRUCTION FOR USE	7
DESCRIPTION	8
Description of appliance.....	8
Description of control panel.....	8
Description of milk container.....	8
Description of accessories.....	8
BEFORE USE	8
Checking the appliance.....	8
Installing the appliance.....	8
Connecting the appliance.....	9
Setting up the appliance.....	9
TURNING THE APPLIANCE ON	9
TURNING THE APPLIANCE OFF	9
MENU SETTINGS	10
Rinsing.....	10
Descaling.....	10
Install filter.....	10
Replacing the filter (if installed).....	10
Adjust time.....	10
Auto-start.....	10
Auto-off.....	10
Auto-standby timer/ auto-off timer.....	10
Energy saving.....	11
Setting the temperature.....	11
Setting water hardness.....	11
Setting the language.....	11
Beep.....	11
Cup lighting.....	11
Default values (reset).....	11
Statistics function.....	11
MAKING COFFEE	12
Selecting the coffee taste.....	12
Selecting the quantity of coffee in the cup.....	12
Coffee selected.....	12
Quantity in cup (ml).....	12
Customising the “my coffee” quantity.....	12
Adjusting the coffee mill.....	12
Tips for a hotter coffee.....	12
Making coffee using coffee beans.....	12
Making coffee using pre-ground coffee.....	13
MAKING MILK BASED DRINKS	13
Filling and attaching the milk container.....	13
Adjusting the amount of froth.....	13
Making milk based drinks automatically.....	14
Clean the milk frother by using the CLEAN button.....	14
Programming the quantity of coffee and milk in the cup for the FLAT WHITE, CAPPUCCINO, LATTE and MILK buttons.....	14
DELIVERING HOT WATER AND STEAM	14
Delivering hot water.....	14
Changing the quantity of water delivered automatically.....	15
Steam delivery.....	15
Tips for using steam to froth milk.....	15
Cleaning the spout after use.....	15
CLEANING	15
Cleaning the coffee grounds container.....	15
Cleaning the drip tray and condensate tray.....	16
Cleaning the inside of the coffee machine.....	16
Cleaning the water tank.....	16
Cleaning the coffee spouts.....	16
Cleaning the pre-ground coffee funnel.....	16
Cleaning the infuser.....	16
Cleaning the milk container.....	17
Cleaning the hot water/steam nozzle.....	17
DESCALING	17
SETTING WATER HARDNESS	18
Measuring water hardness.....	18
Setting water hardness.....	18
WATER SOFTENER FILTER	18
Installing the filter.....	18
Removing the filter.....	19
Electrical connection (UK only).....	19
DISPLAYED MESSAGES	20
TROUBLESHOOTING	21
TECHNICAL DATA	
Voltage:	220-240 V ~ 50/60 Hz max. 10A
Absorbed power:	1450W
Pressure:	15 bar
Max. water tank capacity:	1,3 l
Size: LxHxD:	195x325x500 mm
Cable length:	1,80 m
Weight:	10,8 kg
Coffee beans container capacity:	150 g
CE	The appliance complies with the following EC directives:
•	Low Voltage Directive 2006/95/EC and subsequent amendments;
•	EMC Directive 2004/108/EC and subsequent amendments
•	European Stand-by regulation 1275/2008;
•	Materials and accessories coming into contact with food conform to European regulation 1935/2004.
DISPOSAL	
	In compliance with European directive 2002/96/EC, the appliance must not be disposed of with household waste, but taken to an authorised waste separation and recycling centre.

INTRODUCTION

Thank you for choosing the ETAM36.365 automatic bean to cup espresso and cappuccino machine.

We hope you enjoy using your new appliance.

Take a few minutes to read these instructions.

This will avoid all risks and damage to the appliance.

Symbols used in these instructions

Important warnings are identified by these symbols.

It is vital to follow these warnings.



Danger!

Failure to observe the warning may result in life threatening injury by electric shock.



Important!

Failure to observe the warning could result in injury or damage to the appliance.



Danger of burns!

Failure to observe the warning could result in burns.



Please note :

This symbol identifies important advice or information for the user.

Letters in brackets

The letters in brackets refer to the legend in the description of the appliance on page 2-3.

Troubleshooting and repairs

In the event of problems, first try and resolve them following the information given in the sections "Displayed messages" on page 21 and "Troubleshooting" on page 22.

If this does not resolve the problem or you require further information, you should consult customer services by calling the number given on the annexed guarantee leaflet.

If your country is not among those listed on the sheet, call the number given in the guarantee leaflet.

If repairs are required, contact De'Longhi customer services only.

The addresses are given in the guarantee leaflet provided with the machine.

SAFETY

Fundamental safety warnings



Danger!

This is an electrical appliance and may cause electric shock.

You should therefore follow the safety warnings below:

- Never touch the appliance with damp hands or feet.
- Never touch the plug with damp hands.

- Make sure the socket used is freely accessible at all times, enabling the appliance to be unplugged when necessary.
- Unplug directly from the plug only. Never pull the power cable as you could damage it.
- To disconnect the appliance completely, release the main switch at the side of the appliance by pushing (fig. 2).
- If the appliance is faulty, do not attempt to repair. Turn it off, unplug from the mains socket and contact Customer Services.
- If the plug or power cable is damaged, it must be replaced by De'Longhi customer services only to avoid all risk.



Important!

- Keep all packaging (plastic bags, polystyrene foam) away from children.
- The appliance is not intended for use by persons (including children) with reduced physical, sensory or mental capabilities, or lack of experience and knowledge, unless they have been given supervision or instruction concerning use of the appliance by a person responsible for their safety. Children should be supervised to ensure that they do not play with the appliance.



Danger: Risk of burns!

This appliance produces hot water and steam may form while it is in operation.

Avoid contact with splashes of water or hot steam.

DESIGNATED USE

This appliance is designed and made to prepare coffee and heat drinks.

All other use is considered improper.

This appliance is not suitable for commercial use.

The manufacturer is not liable for damage deriving from improper use of the appliance.

This is a household appliance only.

It is not intended to be used in:

- kitchen areas in shops, offices and other working environments;
- farm houses
- by clients in hotels, motels and other residential type environments
- bed and breakfast type environments.

INSTRUCTION FOR USE

Read these instructions carefully before using the appliance.

- Failure to follow these instructions may result in burns or damage to the appliance.
The manufacturer is not liable for damage deriving from failure to follow these instructions.





Please note:

Keep these instructions. If the appliance is passed to other persons, they must also be provided with these instructions.

DESCRIPTION

Description of appliance







(page 3 - A)

- A1. Top lid
- A2. Beans container
- A3. Pre-ground coffee funnel lid with pressure closure
- A4. Pre-ground coffee funnel
- A5. Beans container lid
- A6. Grinding adjustment dial
- A7. Water tank
- A8. Water tank extraction handle
- A9. Water softener filter housing
- A10. Cup warmer shelf
- A11. Coffee spout (adjustable height)
- A12. Hot water and steam nozzle
- A13. Socket for power cable connector
- A14. Condensate tray
- A15. Cup tray
- A16. Drip tray
- A17. Drip tray water level indicator
- A18. Coffee grounds container
- A19. Infuser
- A20. Main switch
- A21. Infuser door
- A22. Infuser door catch
- A23.  button: turns the appliance on and off (stand-by)
- A24.  button: to enable or disable the cup warmer

Description of control panel

(page 2 - B)

A number of buttons on the panel have a double function. This is indicated in brackets in the description.

- B1.  aroma selection button: press to select coffee taste
- B2.  button: to select coffee quantity
- B3. **MENU** button to access the menu. *(When in the settings menu, press to exit the menu)*
- B4. Display: guides the user in using the appliance
- B5.  /OK button: to deliver hot water *(When in the settings menu, press to confirm the selection)*
- B6.  button: to make 1 cup of coffee with the settings displayed
- B7.  button: to make 2 cups of coffee with the settings displayed
- B8:  button: to deliver steam *(When in the settings menu, press to scroll through the menu items)*

- B9. **MILK** button: to deliver a cup of milk
- B10. **LATTE** button: to deliver a latte
- B11. **CAPPUCCINO** button: to deliver a cappuccino
- B12. **FLAT WHITE** button: to deliver a flat white *(When in the settings menu, press to scroll through the menu items)*

Description of milk container

(page 2 - C)

- C1. Milk container lid
- C2. Froth adjustment and CLEAN dial
- C3. Milk container
- C4. Lid extraction button
- C5. Frothed milk spout (adjustable)
- C6. Milk intake tube

Description of accessories

(page 2 - D)

- D1. Pre-ground coffee measure
- D2. Cleaning brush
- D3. Water softener filter (certain models only)
- D4. Cappuccino maker/hot water spout release button
- D5. Cappuccino maker/hot water spout
- D6. Power cable
- D7. "Total Hardness Test" indicator paper
- D8. Descaler

BEFORE USE

Checking the appliance

After removing the packaging, make sure the product is complete and undamaged and that all accessories are present.

Do not use the appliance if it is visibly damaged.

Contact De'Longhi Customer Services.

Installing the appliance



Important!

When you install the appliance, you should follow the safety warnings below:

- The appliance gives off heat. After positioning the appliance on the worktop, leave a space of at least 3 cm between the surfaces of the appliance and the side and rear walls and at least 15 cm above the coffee machine.
- Water penetrating the appliance could cause damage. Do not place the appliance near taps or sinks.
- The appliance could be damaged if the water it contains freezes. Do not install the appliance in a room where the temperature could drop below freezing point.
- Arrange the power cable in such a way that it cannot be damaged by sharp edges or contact with hot surfaces (e.g. electric hot plates).

Connecting the appliance



Important!

Check that the mains power supply voltage corresponds to the value indicated on the rating plate on the bottom of the appliance.

Connect the appliance to an efficiently earthed and correctly installed socket with a minimum current rating of 10A only.

If the power socket does not match the plug on the appliance, have the socket replaced with a suitable type by a qualified professional.

Setting up the appliance



Please note!

- Coffee has been used to factory test the appliance and it is therefore completely normal for there to be traces of coffee in the mill. The machine is, however, guaranteed to be new.
 - You should customise water hardness as soon as possible following the instructions in the section "Setting water hardness" on page 19.
1. Plug the power cable connector into the socket at the back of the appliance and connect the appliance to the mains electricity supply (fig. 1). Make sure the main switch at the side of the appliance is pressed (fig. 2).

You must first choose the language (the languages scroll through at intervals of about 3 seconds):

2. When "English" appears, press and hold the /OK button (fig. 3) for a few seconds until "English set" is displayed.

Follow the instructions indicated on the appliance display:

3. "FILL TANK": remove the water tank (fig. 4), open the lid (fig. 5), fill to the MAX line with fresh water (fig. 6), replace the lid and put the tank back in the appliance.
4. "INSERT WATER SPOUT": Check that the hot water spout is inserted on the nozzle and place a container with a minimum capacity of 100 ml underneath (fig. 7).
5. "Water delivery Press OK" is displayed;
6. Press the /OK button to confirm (fig. 3). The appliance delivers water from the spout then goes off automatically.

The coffee machine is now ready for normal use.



Please note!

- When setting up the appliance, you need to make 4/5 cups of coffee or 4/5 cappuccinos before the appliance starts to give satisfactory results.
- To enjoy your coffee even more and improve the performance of your appliance, we recommend installing a water

softener filter as described in the section "WATER SOFTENER FILTER" (page 19). If your model is not provided with a filter, you can request one from De'Longhi Customer Services.

TURNING THE APPLIANCE ON



Please note!

Before turning the appliance on, make sure the main switch is pressed (fig. 2).

Each time the appliance is turned on, it performs an automatic preheat and rinse cycle which cannot be interrupted. The appliance is ready for use only after completion of this cycle.



Danger of burns!

During rinsing, a little hot water comes out of the coffee spouts and is collected in the drip tray underneath. Avoid contact with splashes of water.

- To turn the appliance on, press the ON-STANDBY  button (fig. 8). The message "Heating up, Please wait" is displayed.

After heating, the message "RINSING" is displayed. As well as heating the boiler, the appliance also heats the internal circuits by circulating hot water.

The appliance is at temperature when the message indicating the taste and quantity of coffee appears.

TURNING THE APPLIANCE OFF

Whenever the coffee machine is turned off after being used to make coffee, it performs an automatic rinse cycle.



Danger of burns!

During rinsing, a little hot water flows from the coffee spouts. Avoid contact with splashes of water.

To turn the appliance off, press the ON-STANDBY  button (fig. 8). The appliance performs a rinse cycle then goes off (stand-by).



Please note!

If you will not be using the appliance for some time, unplug from the mains socket:

- first turn the appliance off by pressing the ON-STANDBY  button (fig. 8).
- release the main switch at the side of the appliance (fig. 2).



Important!

Never press the main switch while the appliance is on.



MENU SETTINGS

To access the settings menu, press the button corresponding to **MENU**. Scroll through the menu by pressing the scrolling arrow (< or >) (fig. 9).

Rinsing

Use this function to deliver hot water from the spout to heat the internal circuit and make the coffee delivered hotter.

To enable the function, proceed as follows:

1. Press the **MENU/ESC** button to enter the menu;
2. Press the scrolling arrow (< or >) (fig. 9) until "Rinsing" is displayed;
3. Press the /OK button. "Confirm?" is displayed;
4. Press the /OK button (fig. 3). Hot water flows out of the spout, heating the internal circuit and making the coffee delivered hotter.

Descaling

For instructions on descaling, see page 18.

Install filter



For instructions on how to install the filter, see the section "Water softener filter" (page 19).

Replacing the filter (if installed)

For instructions on how to replace the filter, see the section "Replacing the filter" (page 20).

Adjust time

To adjust the time on the display, proceed as follows:

1. Press the **MENU/ESC** button to enter the menu;
2. Press the scrolling arrow (< or >) (fig. 9) until "Adjust time" is displayed;
3. Press the /OK button (fig. 3). The hours flash on the display;
4. Press the scrolling arrow (< or >) (fig. 8) to change the hour;
5. Press the /OK button to confirm. The minutes flash;
6. Press the scrolling arrow (< or >) (fig. 9) to change the minutes;
7. Press the /OK button to confirm.

The time is set: press the **MENU/ESC** button to exit the menu.

Auto-start





You can set the auto-start time in order to have the appliance ready at a certain time (for example in the morning) so you can make coffee immediately.



Please note!



To enable this function, the time must already be set correctly.

To enable Auto-start, proceed as follows:

1. Press the **MENU/ESC** button to enter the menu;
2. Press the scrolling arrow (< or >) (fig. 9) until "Auto-start" is displayed;
3. Press the /OK button. "Enable?" is displayed;
4. Press the /OK button to confirm;
5. Press the scrolling arrow (< or >) to choose the hour;
6. Press the /OK button to confirm;
7. Press the scrolling arrow (< or >) (fig. 9) to change the minutes;
8. Press the /OK button to confirm;
9. Press the **MENU/ESC** button to exit the menu.

Once the time has been confirmed, activation of auto-start is indicated by the small bell () displayed alongside the time.

To disable the function:

1. Select auto-start from the menu;
2. Press the /OK button. "Disable?" is displayed;
3. Press the /OK button to confirm.

The small bell () is no longer displayed.

Auto-off

When this function is enabled:



- the appliance is automatically turned off completely, releasing the main switch. To turn the appliance on again, press the main switch (A20) and then the ON/stand-by button (A23).

When this function is disabled:

- the appliance switches to stand-by; power remains on and it consumes a minimal amount of electricity. To turn the appliance on again, press the ON/stand-by button (A23).

The stand-by time can be modified using "Auto-off timer" (if "Auto-off" is enabled) or "Auto-standby timer" (if "Auto-off" is disabled).

To enable or disable auto-off, proceed as follows:

1. Press the **MENU/ESC** button to enter the menu;
2. Press the scrolling arrow (< or >) (fig. 9) until "Auto-standby timer" (or Auto-off) is displayed;
3. Press the /OK button. "Enable?" or "Disable?" is displayed;
4. Press the /OK button to confirm;
5. Press the **MENU/ESC** button to exit the menu.

Auto-standby timer/ auto-off timer

Auto-off can be set so that the appliance goes off after 15 or 30 minutes, or 1, 2 or 3 hours.

To re-programme Auto-off, proceed as follows:

1. Press the **MENU/ESC** button to enter the menu;
2. Press the scrolling arrow (< or >) (fig. 9) until "Auto-standby timer" (or "Auto-off") is displayed;

3. Press the /OK button;
 4. Press the scrolling arrow (< or >) (fig. 9) until the number of minutes/hours of operation is displayed (15 or 30 minutes, or 1, 2 or 3 hours);
 5. Press the /OK button to confirm;
 6. Press the **MENU/ESC** button to exit the menu.
- Auto-off is programmed.

Energy saving

Use this function to enable or disable energy saving.

When enabled, the function reduces energy consumption in compliance with European regulations.

To disable (or enable) energy saving, proceed as follows:

1. Press the **MENU/ESC** button to enter the menu;
2. Press the scrolling arrow (< or >) (fig. 9) until "Energy saving" is displayed;
3. Press the /OK button. "Disable?" is displayed (or "Enable?" if the function has already been disabled);
4. Press the /OK button to disable (or enable) energy saving mode;
5. Press the **MENU/ESC** button to exit the menu.

When the function is active, "Energy saving" is displayed after a period of inactivity.



Please note!

- When in energy saving mode, a few seconds elapse before the first coffee, cappuccino or milk based coffee is delivered as the appliance must heat up again.
- To prepare a drink, press any button to exit energy saving, then press the button corresponding to the drink you want to make.
- If the milk container is attached to the appliance, the energy saving function is not active.

Setting the temperature

To modify the temperature of the water used to make the coffee, proceed as follows:

1. Press the **MENU/ESC** button to enter the menu;
2. Press the scrolling arrow (< or >) (fig. 9) until "Set temperature" is displayed;
3. Press the /OK button;
4. Press the scrolling arrow (< or >) until the required temperature is displayed (●=low; ●●●●=maximum);
5. Press the /OK button to confirm;
6. Press the **MENU/ESC** button to exit the menu.

Setting water hardness

For instructions on setting water hardness, see page 19.

Setting the language

To modify the language of the display, proceed as follows:

1. Press the **MENU/ESC** button to enter the menu;
2. Press the scrolling arrow (< or >) (fig. 9) until "Set language" is displayed;
3. Press the /OK button;
4. Press the the scrolling arrow (< or >) until the required language is displayed ;
5. Press the /OK button to confirm;
6. The set language is displayed;
7. Press the **MENU/ESC** button to exit the menu.

Beep

This enables or disables the beep emitted by the machine each time the buttons are pressed or an accessory is inserted/removed. To disable or re-enable the beep, proceed as follows:

1. Press the **MENU/ESC** button to enter the menu;
2. Press the scrolling arrow (< or >) (fig. 9) until "Beep" is displayed;
3. Press the /OK button. "Disable?" is displayed (or "Enable?" if disabled);
4. Press the /OK button to enable or disable the beep;
5. Press the **MENU/ESC** button to exit the menu.

Cup lighting

This function enables or disables the cup lighting. The lighting is enabled by default.

The lighting comes on each time coffee, cappuccino or milk based coffee is made and during each rinsing cycle.

To disable or re-enable this function, proceed as follows:

1. Press the **MENU/ESC** button to enter the menu;
2. Press the scrolling arrow (< or >) (fig. 9) until "Cup lighting" is displayed;
3. Press the /OK button. "Disable?" is displayed (or "Enable?" if disabled);
4. Press the /OK button to enable or disable the cup lighting;
5. Press the **MENU/ESC** button to exit the menu.

Default values (reset)

This resets all menu settings and programmed quantities back to the default values (with the exception of the language which remains as set).

To reset the default values, proceed as follows:

1. Press the **MENU/ESC** button to enter the menu;
2. Press the scrolling arrow (< or >) (fig. 9) until "Default values" is displayed;
3. Press the /OK button;
4. "Confirm?" is displayed;
5. Press the /OK button to confirm and exit.

Statistics function

This displays statistics relating to the machine.

To display, proceed as follows:

1. Press the **MENU/ESC** button to enter the menu;
2. Press the scrolling arrow (< or >) (fig. 9) until "Statistics" is displayed;
3. Press the **△/OK** button;
4. By pressing the scrolling arrow (< or >) (fig. 9), you can check:
 - how many coffees have been made;
 - the total number of cappuccinos and milk based coffees;
 - the total number of litres of water delivered;
 - how many times the machine has been descaled;
 - how many times the water softener filter has been replaced.
5. Press the **MENU/ESC** button twice to exit the menu.

MAKING COFFEE

Selecting the coffee taste

The appliance is set by default to make coffee with a standard taste.

You can also choose one of these tastes:

Extra-mild taste

Mild taste

Standard taste

Strong taste

Extra-strong taste

To change the taste, press the  button (fig. 10) repeatedly until the required taste is displayed.

Selecting the quantity of coffee in the cup

The appliance is set by default to make a standard quantity of coffee. To select the quantity of coffee, press the  button (fig. 11) until the message corresponding to the required quantity of coffee is displayed:

Coffee selected	Quantity in cup (ml)
MY COFFEE	Programmable: from ≈20 to ≈180
SHORT	≈40
STANDARD	≈60
LONG	≈90
EXTRA LONG	≈120



Customising the "my coffee" quantity

The appliance is set by default to automatically deliver 30 ml of "my coffee".

To modify this quantity, proceed as follows:

1. Place a cup under the coffee spouts (fig. 12).
2. Press the  button (fig. 10) until "MY COFFEE"

is displayed.

3. Press and hold the  button (fig. 15) until the message "Program quantity 1 MY COFFEE" is displayed and coffee delivery begins. Release the button
4. As soon as the coffee in the cup reaches the required level, press the  button (fig. 15) again.

The quantity of coffee in the cup set has now been programmed.

Adjusting the coffee mill

The coffee mill is set by default to prepare coffee correctly and should not require regulating initially.

However, if after making the first few coffees you find that the coffee is either too weak and not creamy enough or delivery is too slow (a drop at a time), this can be corrected by adjusting the grinding adjustment dial (fig. 13).

 *Please note!*

The grinding adjustment dial must only be turned when the coffee mill is in operation.

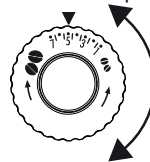

If the coffee is delivered too slowly or not at all, turn one click clockwise towards "7".



For fuller bodied creamier coffee, turn one click anticlockwise towards "1" (do not turn more than one click at a time otherwise the coffee could be delivered a drop at a time).

These adjustments will only be evident after at least 2 cups of coffee have been delivered.

If this adjustment does not obtain the desired result, turn the dial another click.

Tips for a hotter coffee

For hotter coffee, you should:



- perform a rinse cycle by selecting the "Rinsing" function in the settings menu (page 10)
- warm the cups by rinsing them with hot water (using the hot water function);
- increase the coffee temperature in the settings menu (page 11);
- Press the  button to enable the cup warmer (the  symbol is displayed).

Making coffee using coffee beans

 *Important!*



Do not use caramelised or candied coffee beans as they could stick to the coffee mill and make it unusable.

1. Fill the container with coffee beans (fig. 14).
2. Place under the coffee spouts:

- 1 cup, if you want 1 coffee (fig. 15);
 - 2 cups if you want 2 coffees (fig. 17).
3. Lower the spout as near as possible to the cups (fig. 16). This makes a creamier coffee.
 4. Press the button corresponding to the number of coffees required (1 cup  or 2 cups .
 5. Preparation begins. The amount of coffee selected is displayed together with a progress bar which gradually fills as preparation progresses.



Please note:

- While the machine is making coffee, delivery can be interrupted at any moment by pressing one of the delivery buttons.
- At the end of delivery, to increase the quantity of coffee in the cup, just press and hold (within 3 seconds) one of the coffee buttons ( or ).

Once the coffee has been made, the appliance is ready to be used again.



Please note!

- Various alarm messages could be displayed while using the machine (FILL TANK, EMPTY GROUNDS CONTAINER, etc.). Their meaning is explained in the section “Displayed messages” (page 21).
- For hotter coffee, see the section “Tips for a hotter coffee” (page 13).
- If the coffee is delivered a drop at a time, too weak and not creamy enough or too cold, read the tips in the “Troubleshooting” section on page 22.

Making coffee using pre-ground coffee





Important!

- Never add pre-ground coffee when the machine is off or it could spread through the inside of the machine and dirty it. This could damage the appliance.
- Never use more than one level measure as it could dirty the inside of the machine or block the funnel.



Please note!

If you use pre-ground coffee, you can only make one cup of coffee at a time.

1. Press the aroma selection button  (fig. 10) until “Pre-ground” is displayed.
2. Open the beans container lid, then open and raise the pre-ground coffee funnel lid.
3. Make sure the funnel is not blocked, then add one level measure of pre-ground coffee (fig. 18).
4. Place a cup under the coffee spouts.
5. Press the 1 cup button  (fig. 15).

6. Preparation begins. The amount of coffee selected is displayed together with a progress bar which gradually fills as preparation progresses.



Please note!

If “Energy saving” mode is active, you may have to wait a few seconds before the first coffee is delivered.

MAKING MILK BASED DRINKS



Please note!

- To avoid producing milk with poor froth or large bubbles, always clean the milk container lid and hot water nozzle as described in the section “Cleaning the milk container” on pages 15 and 18.

Filling and attaching the milk container

1. Remove the lid by pressing the release button C4 and at the same time lifting the lid upwards (fig. 19);
2. Fill the milk container with a sufficient quantity of milk, not exceeding the MAX level marked on the container (fig. 20). Each mark on the side of the container corresponds to about 100 ml of milk.





Please note!

- For a denser more even froth, you must use skimmed or partially skimmed milk at refrigerator temperature (about 5°C).
 - If “Energy saving” mode is enabled, you may have to wait a few seconds before the drink is delivered.
3. Make sure the milk intake tube is correctly inserted in the bottom of the milk container lid (fig. 21).
 4. Replace the lid on the milk container and press downwards until it clicks in place.
 5. Extract the hot water spout by pressing the button on the spout (fig. 22A)
 6. Attach the milk container to the nozzle and push as far as it will go (fig. 23). The machine emits a beep (if the beep function is enabled).
 7. Place a sufficiently large cup under the coffee and frothed milk spouts. Adjust the length of the milk spout. To move it nearer the cup, simply pull it downwards (fig. 24).
 8. Follow the instructions below for each function.

Adjusting the amount of froth

Turn the froth adjustment dial to adjust the amount of froth on the milk delivered while making cappuccino and milk based coffees.

Dial position	Description	Recommended for. . .

	No froth	FLAT WHITE/ MILK (hot milk)
	Min. froth	LATTE
	Max. froth	CAPPUCCINO/ MILK (frothed milk)

Making milk based drinks automatically

The FLAT WHITE, CAPPUCCINO, LATTE and MILK buttons on the control panel enable these drinks to be prepared automatically. Proceed as follows:

1. Fill the milk container and attach it as described above.
2. Turn the froth adjustment dial on the milk container lid to the position corresponding to the required froth.
3. Press the button corresponding to the required drink. The name of the drink selected is displayed together with a progress bar which gradually fills as preparation progresses.
4. After a few seconds, frothed milk is delivered from the milk spout into the cup below.
For drinks with coffee, the machine automatically makes the coffee after delivering the milk.

Please note!

- If you want to interrupt preparation during delivery, press any button.
- At the end of delivery, to increase the quantity of milk or coffee in the cup, within three seconds, just press and hold the button corresponding to the cappuccino or milk based coffee being made.
- Do not leave the milk container out of the refrigerator for long periods. The warmer the milk (5°C is ideal), the poorer the quality of froth produced.

Clean the milk frother by using the CLEAN button

Important! Danger of burns

When cleaning the internal tubes of the milk container, a little hot water and steam leak out of the frothed milk spout. Avoid contact with splashes of water.

“TURN DIAL TO CLEAN” flashes on the display each time you use a milk function. To eliminate all milk residues, proceed as follows:

1. Leave the milk container in the machine (you do not need to empty it);
2. Place a cup or other recipient under the frothed milk spout.
3. Turn the froth adjustment dial to “CLEAN” (fig. 25). “Clean-

ing underway, Please wait” is displayed, together with a progress bar which gradually fills as the operation proceeds. Cleaning stops automatically.

4. Turn the dial back to one of the froth selections.
5. Remove the milk container and always clean the steam nozzle with a sponge (fig. 26).

Please note!

- To prepare a number of cappuccinos and milk based coffees, clean the milk container after you have prepared the last drink only.
- The milk container can be kept in the refrigerator.
- In some cases, to clean you must wait for the appliance to heat up.

Programming the quantity of coffee and milk in the cup for the FLAT WHITE, CAPPUCCINO, LATTE and MILK buttons

The appliance is set by default to automatically deliver standard quantities. To change these quantities, proceed as follows:

1. Place a cup under the coffee spouts and milk spout.
2. Press and hold one of the function buttons until the message “Program quantity, PROGRAM MILK” is displayed.
3. Release the button. The appliance starts delivering milk.
4. Once the required quantity of milk has been delivered into the cup, press the button again.
5. The appliance stops delivering milk and, if required for the drink being prepared, after a few seconds the coffee is delivered into the cup. “Program quantity, PROGRAM COFFEE” is displayed.
6. Once the required quantity of coffee has been delivered into the cup, press the button again. Coffee delivery stops.

The machine is now reprogrammed with the new milk and coffee quantities.

DELIVERING HOT WATER AND STEAM

Important! Danger of burns.

Do not leave the appliance unattended while hot water or steam is being delivered. The spout becomes hot during delivery. Hold by the handle only.



Please note!

If “Energy saving” is active, you may have to wait a few seconds before hot water and steam are delivered.

Delivering hot water

1. Make sure the hot water spout is attached correctly (fig. 7).
2. Place a container under the spout (as close as possible to

avoid splashes).

3. Press the /OK button (fig. 3). "Preparation underway" is displayed (if required). Then hot water is delivered and "HOT WATER" is displayed, together with a progress bar which fills gradually as preparation proceeds.
4. The machine delivers about 250 ml of hot water, then delivery stops automatically. To interrupt delivery of hot water manually, press the /OK button again.

Changing the quantity of water delivered automatically.



The machine is set by default to automatically deliver 250 ml of hot water.

To modify these quantities, proceed as follows:

1. Position a container under the spout.
2. Press and hold the /OK button until "Program quantity HOT WATER" is displayed, then release.
3. When the hot water in the cup reaches the required level, press the /OK button again.

The machine is now reprogrammed with the new quantity.

Steam delivery

1. Make sure the hot water spout is attached correctly (fig. 7).
2. Fill a container with the liquid to be heated/frothed and immerse the spout/cappuccino maker (D5) in the liquid.
3. Press the steam () button. After a few seconds, the steam to heat the liquid comes out of the cappuccino maker and "STEAM" is displayed.
4. When the required temperature is obtained, interrupt steam delivery by pressing the steam () button again. (You should not discharge steam for more than 3 minutes at a time).



Important!

Always stop steam delivery before extracting the container containing the liquid to avoid burns from splashes.



Tips for using steam to froth milk

- When choosing the size of the container, bear in mind that the liquid doubles or triples in volume.
- For a richer denser froth, use skimmed or partially skimmed milk at refrigerator temperature (about 5°C).
- For a creamier froth, rotate the container with slow movements in an upward direction.
- To avoid milk with poor froth or large bubbles, always clean the spout as described in the following section.

Cleaning the spout after use

Always clean the spout after use to avoid the build-up of milk residues and prevent the spout from clogging.

1. Place a container under the cappuccino maker and press

the /OK button to deliver a little water (fig. 3). Stop the flow of hot water by pressing the /OK button again.

2. Wait a few minutes for the cappuccino maker to cool down, then press the button on the hot water spout and extract it. Hold the spout with one hand and with the other, turn the cappuccino maker anticlockwise (fig. 22) and pull downwards to remove.
3. Also remove the steam nozzle by pulling it downwards (fig. 27A).
4. Check the hole shown by the arrow in fig. 27B is not blocked. If necessary, clean with a pin.
5. Wash all parts of the cappuccino maker thoroughly with a sponge and warm water.
6. Reinsert the nozzle and replace the cappuccino maker on the nozzle, pushing it upwards and turning it until it is attached.

CLEANING



Important!

- Do not use solvents, abrasive detergents or alcohol to clean the coffee machine. With De'Longhi superautomatic bean to cup espresso and cappuccino machines, you need not use chemical products to clean the machine.
- None of the components of the appliance can be washed in a dishwasher with the exception of the milk container (C).
- Do not use metal objects to remove encrustations or coffee deposits as they could scratch metal or plastic surfaces.

Cleaning the coffee grounds container

When "EMPTY GROUNDS CONTAINER" is displayed, the grounds container must be emptied and cleaned.

The appliance cannot be used to make coffee until you have cleaned the grounds container.

Even if not full, the empty grounds container message is displayed 72 hours after the first coffee has been prepared. For the 72 hours to be calculated correctly, the machine must never be turned off with the main switch in the 0 position.



Important! Danger of burns

If you make a number of cappuccinos one after the other, the metal cup tray becomes hot.

Wait for it to cool down before touching it and handle it from the front only.

To clean (with the machine on):

- Remove the drip tray (fig. 28), empty and clean.
- Empty the grounds container and clean thoroughly to remove all residues left on the bottom. This can be done with the spatula on the brush provided.

- Check the condensate tray and empty if necessary (fig. 29).



Important!

When removing the drip tray, the grounds container must be emptied, even if it contains few grounds.

If this is not done, when you make the next coffees, the grounds container may fill up more than expected and clog the machine.

Cleaning the drip tray and condensate tray



Important!

The drip tray is fitted with a level indicator (red) showing the level of water it contains (fig. 30).

Before the indicator protrudes from the cup tray, the drip tray must be emptied and cleaned, otherwise the water may overflow the edge and damage the appliance, the surface it rests on or the surrounding area.

To remove the drip tray:

1. Remove the drip tray and grounds container (fig. 28);
2. Empty the drip tray and grounds container and wash them;
3. Check the condensate tray and empty if necessary.
4. Replace the drip tray complete with grounds container.

Cleaning the inside of the coffee machine



Danger of electric shock!

Before cleaning internal parts, the machine must be turned off (see "Turning off") and unplugged from the mains power supply.

Never immerse the coffee machine in water.

1. Check regularly (about once a week) that the inside of the appliance (accessible after removing the drip tray) is not dirty. If necessary, remove coffee deposits with the brush supplied and a sponge.
2. Remove the residues with a vacuum cleaner (fig. 31).

Cleaning the water tank

1. Clean the water tank (A7) regularly (about once a month) and whenever you replace the water softener filter (if provided) with a damp cloth and a little mild washing up liquid.
2. Remove the filter (if present) and rinse with running water.
3. Replace the filter (if provided), fill the tank with fresh water and replace the tank.

Cleaning the coffee spouts

1. Clean the coffee spouts regularly with a sponge or cloth (fig. 32).
2. Check the holes in the coffee spout are not blocked. If necessary, remove coffee deposits with a toothpick (fig. 33).

Cleaning the pre-ground coffee funnel

Check regularly (about once a month) that the pre-ground coffee funnel (A4) is not blocked.

If necessary, remove coffee deposits with the brush (D2) supplied.

Cleaning the infuser

The infuser (A19) must be cleaned at least once a month.



Important!

The infuser may not be extracted when the machine is on.

1. Make sure the machine is correctly turned off (see "Turning off", page 10).
2. Open the infuser door (fig. 34) on the right side of the appliance.
4. Press the two red release buttons inwards and at the same time pull the infuser outwards (fig. 35).
5. Soak the infuser in water for about 5 minutes, then rinse under the tap.

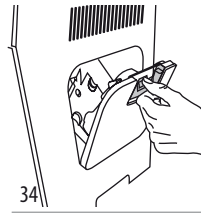

34

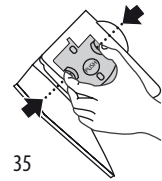

35



Important!

RINSE WITH WATER ONLY

NO WASHING UP LIQUID - NO DISH WASHER

Do not use washing up liquid to clean the infuser as it may damage it.

6. Use the brush (D2) to remove any coffee residues left in the infuser housing, visible through the infuser door.
7. After cleaning, replace the infuser by sliding it onto the internal support, then push the PUSH symbol fully in until it clicks into place.



i Please note!

If the infuser is difficult to insert, before insertion, squeeze the two levers shown in the figure to make it smaller.

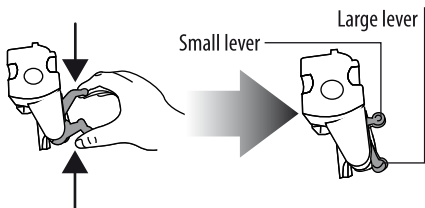

- Once inserted, make sure the two red buttons have snapped out.



- Close the infuser door.
- Replace the water tank.

Cleaning the milk container

Clean the milk container each time you prepare milk as described below:

- Remove the lid.
- Remove the milk spout and intake tube.
- Turn the froth adjustment dial clockwise to the "INSERT" position (see figure) and pull off upwards.

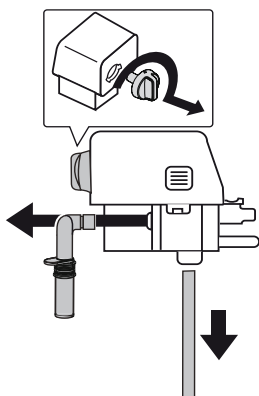

- Wash all the components thoroughly with hot water and mild washing-up liquid. All components are dishwasher safe, placing them in the top basket of the dishwasher. Make sure there are no milk residues on the hollow and groove under the dial (see figure alongside). If necessary, scrape the groove with a toothpick.

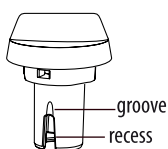

- Rinse inside the froth adjustment dial seat with running

water (see figure).

- Check that the intake tube and spout are not clogged with milk residues.
- Replace the dial (lining up the arrow with the word "INSERT"), the spout and the milk intake tube.
- Place the lid back on the milk container.

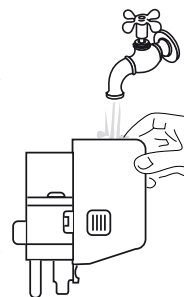

Cleaning the hot water/steam nozzle

Each time you prepare milk, clean the nozzle with a sponge to remove milk residues from the gaskets.

DESCALING



Descale the machine when the message "DESCALE" and the relative symbol  flash on the display.

 Important!

- Descaler contains acids which may irritate the skin and eyes. It is vital to follow the manufacturer's safety warnings given on the descaler pack and the warnings relating to the procedure to follow in the event of contact with the skin and eyes.
- Use De'Longhi descaler only. Under no circumstances should you use sulphamic or acetic based descalers. Their use invalidates the guarantee. Failure to descale the appliance as described above also invalidates the guarantee.

- Turn the machine on.
- Press the **MENU/ESC** button to enter the menu.

- Press < or > until "Descal" is displayed.

- Select by pressing the /OK button: "Confirm?" is displayed. Press the /OK button to confirm.

- "DESCALE", "EMPTY DRIP TRAY" is displayed, alternating with "Remove filter" (if the filter is present) and "ADD DESCALER PRESS OK".

- Empty the water tank (A9) completely and remove the water softener filter (if present). Empty the drip tray (fig. 29) and grounds container, then put them back in the appliance.

- Pour the descaler into the tank up to level **A** (correspond-

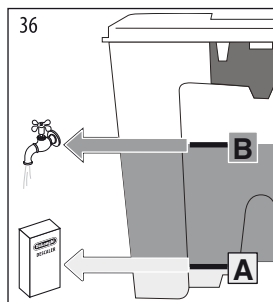

ing to a 100 ml pack) marked on the back of the tank (fig. 36), then add water (1 litre) up to level **B** (fig. 36) and put the water tank back.

- Place an empty container with a minimum capacity of 1.5 litres under the hot water spout (fig. 7).



Important! Danger of burns

Hot water containing acid flows out of the hot water spout. Avoid contact with splashes of water.

- Press the button to confirm that you have added the solution. The descale programme automatically performs a series of rinses and pauses to remove limescale deposits from inside the machine. "DESCALE, Please wait" is displayed. The descale programme starts and the descaler liquid comes out of the water spout.

After about 30 minutes, the message "RINSING, INSERT FILTER" (if previously removed), FILL TANK" is displayed.

- The appliance is now ready for rinsing through with clean water. Remove the water tank, empty, rinse under running water, reinsert the water filter (if previously removed) fill with clean water and replace. "RINSING, Press OK" is displayed.
- Empty the container used to collect the descaler solution and replace it empty under the hot water spout.
- Press the button to start rinsing. Hot water flows out of the spout and the message "RINSING, Please wait" is displayed.
- When the water tank is completely empty, the message "Rinsing complete, Press OK" is displayed.
- Press the button.
- "Heating up, please wait" is displayed: when completed, the appliance is ready for use.

SETTING WATER HARDNESS

The "DESCALE" message is displayed after a period of time established according to water hardness.

The machine is set by default for a hardness value of 4.

The machine can also be programmed according to the hardness of the mains water in the various regions so that the machine needs to be descaled less often.

Measuring water hardness

- Remove the "TOTAL HARDNESS TEST" indicator paper attached to these instructions from its pack.
- Immerse the paper completely in a glass of water for one second.
- Remove the paper from the water and shake lightly. After about a minute, 1, 2, 3, or 4 red squares form, depending on the hardness of the water. Each square corresponds to one level.

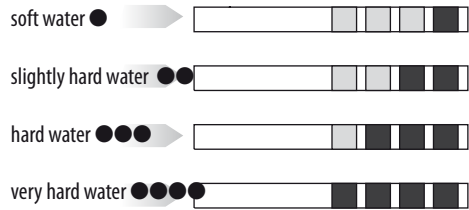

Setting water hardness

- Press the **MENU/ESC** button to enter the menu.
- Press the scrolling arrow (< or >) until "Water Hardness" is displayed.
- Press the button to confirm the selection.
- Press the scrolling arrow (< or >) repeatedly to set the level as measured by the indicator paper (see previous section).
- Press the button to confirm the setting.
- Press the **MENU/ESC** button to exit the menu.

The machine is now reprogrammed with the new water hardness setting.

WATER SOFTENER FILTER

Certain models are fitted with a water softener filter. If this is not the case with your model, you are recommended to purchase one from De'Longhi Customer Services.

To use the filter correctly, follow the instructions below.

Installing the filter

- Remove the filter from the packaging.
- Turn the date indicator disk (see fig. 37) until the next two months of use are displayed.



Please note

The filter lasts about two months if the appliance is used normally. If the coffee machine is left unused with the filter installed, it will last a maximum of three weeks.

- To activate the filter, put it under tap water until the water overflows the side openings for more than one minute (min. 500ml) (fig. 38).
- Extract the tank from the appliance and fill with water.

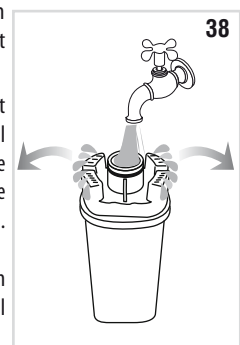
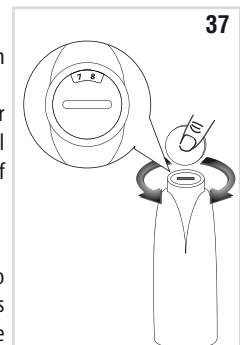

- Place the filter in the water tank and submerge it completely for ten seconds, tilting it to enable the air bubbles to escape (fig. 39).



- Insert the filter into the filter housing and press as far as it will go (fig. 40A).

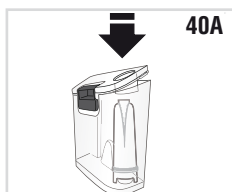

- Close the tank with the lid (fig. 40B), and then replace the tank in the machine.



When you install the filter, you must notify the appliance of its presence.

- Press the **MENU/ESC** button to enter the menu;
- Press the scrolling arrow (< or >) (fig. 9) until "Install filter" is displayed.
- Press the Δ /OK button.
- "Install?" is displayed;
- Press the Δ /OK button to confirm the selection. "Water delivery Press OK" is displayed.
- Position a container under the hot water spout (min. capacity: 100 ml).
- Press the Δ /OK button to confirm the selection. The appliance begins hot water delivery and the message "Please wait" is displayed.
- After delivery, the appliance is automatically ready to make the next drink.

The filter is now active and you can use the coffee machine.

Replacing the filter

When the symbol "F" is displayed together with the message "REPLACE FILTER", after two months (see date indicator) or when the appliance has not been used for 3 weeks, you should replace the filter:

- Extract the tank and exhausted filter;
- Remove the new filter from the packaging and proceed following steps from 2 to 6 of the paragraph before.
- Position a container with a minimum capacity of 100 ml under the hot water spout.
- Press the **MENU/ESC** button to enter the menu;
- Press < or > until "Replace filter" is displayed.
- Press the Δ /OK button;
- "Confirm?" is displayed;
- Press the Δ /OK button to confirm the selection;

- "Water delivery, Press OK" is displayed.
- Press the Δ /OK button to confirm the selection. The appliance begins hot water delivery and the message "Please wait" is displayed.
- After delivery, the appliance is automatically ready to make the next drink.

The new filter is now active and you can use the coffee machine.

Removing the filter

If you want to use the appliance without the filter, you must remove it and notify the appliance of its removal.

Proceed as follows:

- Extract the tank and exhausted filter;
- Press the **MENU/ESC** button to enter the menu;
- Press the scrolling arrow (< or >) (fig. 9) until "Install filter, Installed" is displayed.
- Press the Δ /OK button;
- The message "Uninstall?" appears on the display;
- Press the Δ /OK button to confirm and the **MENU/ESC** button to exit the menu.

Electrical connection (UK only)

- If your appliance comes fitted with a plug, it will incorporate a 13 Amp fuse. If it does not fit your socket, the plug should be cut off from the mains lead, and an appropriate plug fitted, as below. **WARNING:** Very carefully dispose of the cut off plug after removing the fuse: do not insert in a 13 Amp socket elsewhere in the house as this could cause a shock hazard. With alternative plugs not incorporating a fuse, the circuit must be protected by a 15 Amp fuse. If the plug is a moulded-on type, the fuse cover must be re-fitted when changing the fuse using a 13 Amp Asta approved fuse to BS 1362. In the event of losing the fuse cover, the plug must NOT be used until a replacement fuse cover can be obtained from your nearest electrical dealer. The colour of the correct replacement fuse cover is that as marked on the base of the plug.
- If your appliance is not fitted with a plug, please follow the instructions provided below:

WARNING - THIS APPLIANCE MUST BE EARTHED

IMPORTANT

GREEN AND YELLOW
BLUE
BROWN

EARTH
NEUTRAL
LIVE

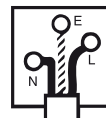

As the colours of the wires in the mains lead may not correspond with the coloured markings identifying the terminals in your plug, proceed as follows:

The green and yellow wire must be connected to the terminal in the plug marked with the letter E or the earth symbol \perp or coloured green or green and yellow.

The blue wire must be connected to the terminal marked with the letter N or coloured black.

The brown wire must be connected to the terminal marked with the letter L or coloured red.



DISPLAYED MESSAGES

DISPLAYED MESSAGE	POSSIBLE CAUSE	SOLUTION
FILL TANK	Insufficient water in the tank.	Fill the tank with water and/or insert it correctly, pushing it as far as it will go until it clicks into place.
EMPTY GROUNDS CONTAINER	The grounds container (A18) is full.	Empty the grounds container and drip tray, clean and replace (fig. 29). Important: when removing the drip tray, the grounds container MUST be emptied, even if it contains few grounds. If this is not done, when you make the next coffees, the grounds container may fill up more than expected and clog the machine.
GROUND TOO FINE ADJUST MILL	The grinding is too fine and the coffee is delivered too slowly or not at all.	Repeat coffee delivery and turn the grinding adjustment dial (fig. 13) one click clockwise towards "7" while the coffee mill is in operation. If after making at least 2 coffees delivery is still too slow, repeat the correction procedure, turning the grinding adjustment dial another click until delivery is correct (see the section "Adjusting the coffee mill" on page 13).
INSERT GROUNDS CONTAINER	After cleaning, the grounds container has not been replaced.	Remove the drip tray and insert the grounds container.
ADD PRE-GROUND COFFEE	The "pre-ground coffee" function has been selected without placing any pre-ground coffee in the funnel.	Place pre-ground coffee in the funnel or deselect the "pre-ground" function (fig. 18).
DESCALE	The machine must be descaled.	The descaling procedure described in the section "Descaling" needs to be performed as soon as possible (page 18).
REDUCE COFFEE AMOUNT	Too much coffee has been used.	Select a milder taste by pressing the aroma selection  button (fig. 10) or reduce the quantity of pre-ground coffee.
FILL BEANS CONTAINER	The coffee beans have run out.	Fill the beans container (fig. 14).
	The pre-ground coffee funnel is clogged.	Empty the funnel with the help of a brush as described in the section "Cleaning the pre-ground coffee funnel".
INSERT INFUSER ASSEMBLY	The infuser has not been replaced after cleaning.	Insert the infuser as described in the section "Cleaning the infuser".
INSERT TANK	The tank is not correctly in place.	Insert the tank correctly and press as far as it will go.
GENERAL ALARM	The inside of the appliance is very dirty.	Clean the inside of the appliance thoroughly, as described in the section "Cleaning". If the message is still displayed after cleaning, contact customer services.
WATER CIRCUIT EMPTY FILL WATER CIRCUIT Water delivery PRESS OK	The water circuit is empty	Press OK to deliver water from the spout (A11) until it flows out normally.
REPLACE FILTER	The water softener filter is exhausted.	Replace the filter or remove it as described in the section "Water softener filter".
TURN DIAL TO CLEAN	Milk has been delivered recently and the tubes inside the milk container must be cleaned.	Turn the froth adjustment dial to CLEAN.
INSERT WATER SPOUT	The water spout is not inserted or is inserted incorrectly.	Insert the water spout (D5) as far as it will go.
INSERT MILK CONTAINER	The milk container is not inserted correctly.	Insert the milk container (fig. 23) as far as it will go.
DESCALE	Descaling is necessary.	See par. "DESCALING".
REPLACE FILTER	Replace water filter.	See par. "Replace water filter".

TROUBLESHOOTING

Below is a list of some of the possible malfunctions.

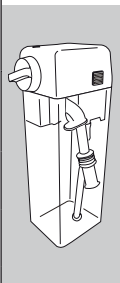
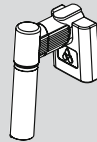
If the problem cannot be resolved as described, contact customer services.

PROBLEM	POSSIBLE CAUSE	SOLUTION
The coffee is not hot.	The cups were not preheated.	<ul style="list-style-type: none"> Enable the cup warmer, leave the cups at least 20 minutes to warm up. Warm the cups by rinsing them with hot water (PLEASE NOTE you can use the hot water function).
	The infuser has cooled down because 2/3 minutes have elapsed since the last coffee was made.	Before making the coffee, heat the infuser by rinsing, using the rinse function (page 10).
	A low coffee temperature is set.	Set a higher coffee temperature in the menu.
The coffee is weak or not creamy enough.	The coffee is ground too coarsely.	Turn the grinding adjustment dial one click anticlockwise towards "1" while the coffee mill is in operation (fig. 13). Continue one click at a time until coffee delivery is satisfactory. The effect is only visible after delivering 2 coffees (see the section: "Adjusting the coffee mill" on page 13).
	The coffee is unsuitable.	Use pre-ground coffee for espresso machines only.
The coffee is delivered too slowly or a drop at a time.	The coffee is ground too finely.	Turn the grinding adjustment dial one click clockwise towards "7" while the coffee mill is in operation (fig. 13). Continue one click at a time until coffee delivery is satisfactory. The effect is only visible after delivering 2 coffees (see the section: "Adjusting the coffee mill" on page 12).
Coffee does not come out of one or both of the spouts.	The spouts are blocked.	Clean the spouts with a toothpick (fig. 33B).
 <p>The milk does not come out of the milk spout.</p> <p>The milk contains large bubbles and squirts out of the milk spout or there is little froth.</p>	The milk container lid is dirty.	Clean the milk container lid as described in the section "Cleaning the milk container".
	The milk is not cold enough or is not semi-skimmed.	Use skimmed or semi-skimmed milk at refrigerator temperature (about 5° C). If the result is not as you wished, try changing brand of milk.
	The froth adjustment dial is incorrectly adjusted.	Adjust following the instructions in the section "Making cappuccino and milk based coffees".
	The milk container lid or froth adjustment dial are dirty	Clean the milk container lid and dial as described in the section "Cleaning the milk container".
	The hot water/steam nozzle is dirty	Clean the nozzle as described in the section "Cleaning the hot water/steam nozzle".
 <p>The milk contains large bubbles and squirts out of the milk spout or there is little froth.</p>	The spout is dirty.	Clean as described in the section "Cleaning the spout after use".
The appliance does not come on.	The connector is not inserted correctly.	Insert the connector as far as it will go in the socket at the back of the appliance.
	It is not plugged into the mains socket.	Plug into the mains socket.
	The main switch (A20) is not turned on.	Press the main switch (fig. 2).
The infuser cannot be extracted	The appliance has not been turned off correctly	Turn the appliance off by pressing the ON-STANDBY  button (page 9)

Free Manuals Download Website

<http://myh66.com>

<http://usermanuals.us>

<http://www.somanuals.com>

<http://www.4manuals.cc>

<http://www.manual-lib.com>

<http://www.404manual.com>

<http://www.luxmanual.com>

<http://aubethermostatmanual.com>

Golf course search by state

<http://golfingnear.com>

Email search by domain

<http://emailbydomain.com>

Auto manuals search

<http://auto.somanuals.com>

TV manuals search

<http://tv.somanuals.com>