



INSTALLATION and SERVICE INSTRUCTIONS
USE and CARE INSTRUCTIONS

D 61 E
CERAMIC COOKER



distributed by
DèLonghi
Pty Ltd

Dear Customer,

Thank you for having purchased and given your preference to our product.

The safety precautions and recommendations reported below are for your own safety and that of others. They will also provide a means by which to make full use of the features offered by your appliance.

Please keep this booklet in a safe place. It may be useful in future, either to yourself or to others in the event that doubts should arise relating to its operation.

This appliance must be used only for the task it has explicitly been designed for, that is for cooking foodstuffs. Any other form of usage is to be considered as inappropriate and therefore dangerous.

The manufacturer declines all responsibility in the event of damage caused by improper, incorrect or illogical use of the appliance or by faulty installation.

PRODUCT LABEL

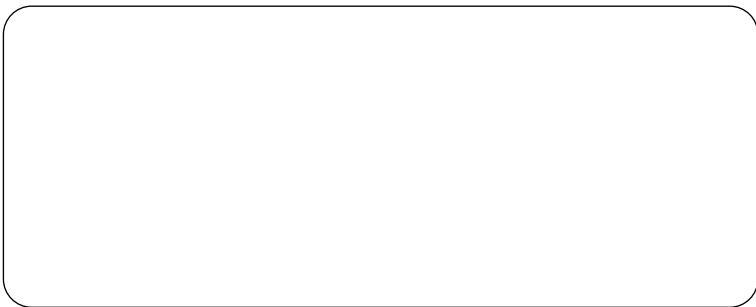

FIRST TIME USE THE OVEN

It is advised to follow these instructions:

- Clean the interior of the oven with cloth soaked in water and detergent (neutral) then dry carefully.
- Fit the wire racks as described at chapter "Use and care".
- Insert shelves and tray.
- Switch on the empty oven on max to eliminate grease tracks from the heating elements.

IMPORTANT PRECAUTIONS AND RECOMMENDATIONS FOR USE OF ELECTRICAL APPLIANCES

Use of any electrical appliance implies the necessity to follow a series of fundamental rules. In particular:

- Never touch the appliance with wet hands or feet;
- do not operate the appliance barefooted;
- The appliance is not intended for use by young children or infirm persons with supervision
- Young children should be supervised to ensure they do not play with the appliance

The manufacturer cannot be held responsible for any damages caused by improper, incorrect or illogical use of the appliance.

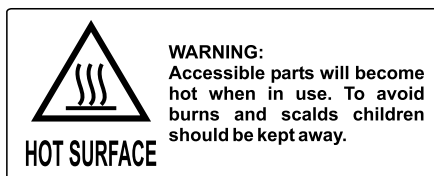

IMPORTANT PRECAUTIONS AND RECOMMENDATIONS

After having unpacked the appliance, check to ensure that it is not damaged.

In case of doubt, do not use it and consult your supplier or a professionally qualified technician.

Packing elements (i.e. plastic bags, polystyrene foam, nails, packing straps, etc.) should not be left around within easy reach of children, as these may cause serious injuries.

- Do not attempt to modify the technical characteristics of the appliance as this may become dangerous to use.
- Do not carry out cleaning or maintenance operations on the appliance without having previously disconnected it from the electric power supply.
- After use, ensure that the knobs are in off position.
- Do not allow children or other incapable people to use the appliance without supervision.
- During and after use of the cooker, certain parts will become very hot. Do not touch hot parts.
- Keep children away from the cooker when it is in use.
- Some appliances are supplied with a protective film on steel and aluminium parts. This film must be removed before using the appliance.
- Fire risk! Do not store flammable material in the oven, and in the accessory drawer.
- Make sure that electrical cables connecting other appliances in the proximity of the cooker cannot come into contact with the hob or become entrapped in the oven door.
- Do not line the oven walls with aluminium foil. Do not place baking trays or the drip tray on the base of the oven chamber.
- The manufacturer declines all liability for injury to persons or damage to property caused by incorrect or improper use of the appliance.
- Do not allow heavy or sharp objects to drop on the glass ceramic hob. If the hob is cracked or otherwise damaged by falling objects etc., disconnect the electrical power cord and call Customer Service.
- Do not scratch the hob with sharp objects. Don't use the hob as a work surface.
- The manufacturer declines all liability for injury to persons or damage to property caused by incorrect or improper use of the appliance.
- The various components of the appliance are recyclable. Dispose of them in accordance with the regulations in force in your country. If the appliance is to be scrapped, cut off the power cord.
- **IMPORTANT NOTE: This appliance shall not be used as a space heater, especially if installed in marine craft or caravans.**

This cooker has been designed and constructed in accordance with the following codes and specifications:

AS/NZS 3350-1	General Requirements for Domestic electrical appliances
AS/NSZ 3350-2-6	Particular Requirements for Domestic electrical cooking appliances
AS/NSZ 1044	Electromagnetic Compatibility Requirements.

INSTALLATION

CAUTION:

- This appliance must be installed in accordance with these installation instructions.
- This appliance shall only be serviced by authorized personnel.
- This appliance is to be installed only by an authorised person.
- Incorrect installation, for which the manufacturer accepts no responsibility, may cause personal injury or damage.
- Always disconnect the cooker from mains power supply before carrying out any maintenance operations or repairs.

ELECTRICAL REQUIREMENTS

- The appliance must be connected to the mains checking that the voltage corresponds to the value given in the rating plate and that the electrical cable sections can withstand the load specified on the plate.
- The appliance must be connected directly to the mains placing an two pole switch with minimum opening between the contacts of 3 mm between the appliance and the mains.
- The power supply cable must not touch the hot parts and must be positioned so that it does not exceed 75°C at any point.
- Once the appliance has been installed, the switch or socket must always be accessible.
- If the power supply cable is damaged it must be substituted by a suitable cable available according to current electrical regulations.

N.B. The connection of the appliance to earth is mandatory.

If the installation requires alterations to the domestic electrical system call a qualified electrician. He should also check that the socket cable section is suitable for the power drawn by the appliance.

Replacing the power cord must be done by a qualified electrician in accordance with the instructions supplied by the manufacturer and in compliance with established electrical regulations.

IMPORTANT

- The appliance should be installed by a registered electrician in compliance with the current electrical regulations and in observation of the instructions supplied by the manufacturer.
Failure to comply with this condition will render the guarantee invalid.
- Always disconnect the cooker from mains power supply before carrying out any maintenance operations or repairs.

LOCATION

The cooker has type "Y" overheating protection so that it can be installed in a cabinet. The cooker must be installed no less than 50 mm away from any side wall which exceed the height of the cooktop; The appliance must be housed in heat resistant units. The walls of the units must be capable of resisting temperatures of 75 °C above room temperature. Do not install the appliance near inflammable materials (eg. curtains).

Figure 1

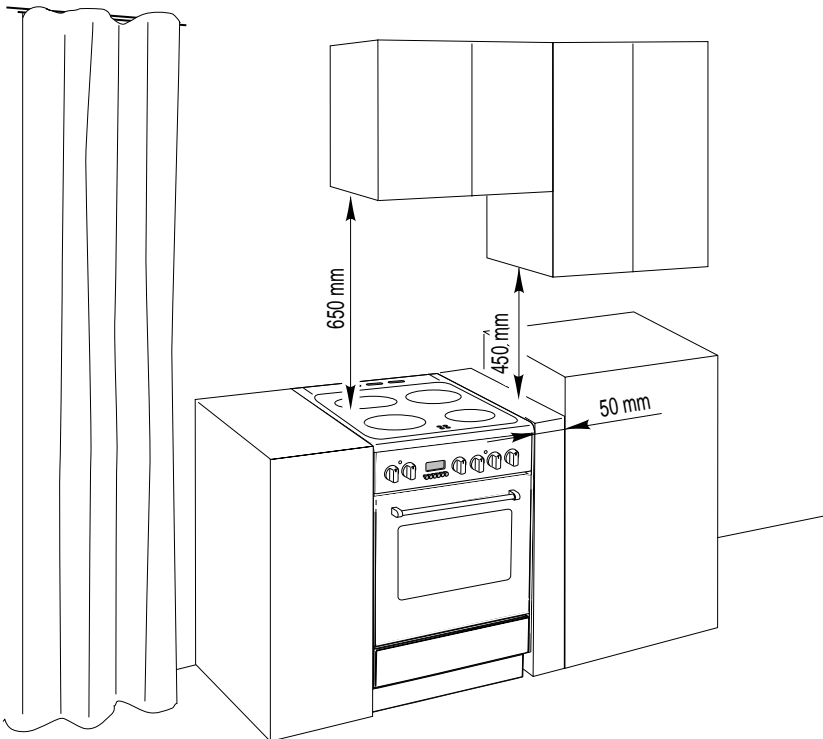

ANTI-TILT BRACKET

Warning: This appliance must be restrained to prevent accidental tipping by fitting a bracket to the rear of the appliance and securely fixing it to the wall.

Fixing the anti-tilt bracket:

- After you have located where the cooker is to be positioned mark, on the wall, the place where the 2 screws of the anti-tilt bracket have to be fitted. Please follow the indications given in the drawing below.
- Make two holes of diameter 8mm diameter on the wall and insert the plastic plugs.
- Attach the anti-tilt bracket loosely by means of 2 screws.
- Move the cooker to the wall and adjust the height of the anti-tilt bracket so that it can engage in one slot of the cooker back.
- Attach the anti-tilt bracket tight.
- Push the cooker against the wall so that the anti-tilt bracket is fully inserted in one slot of the cooker back.

Figure 2

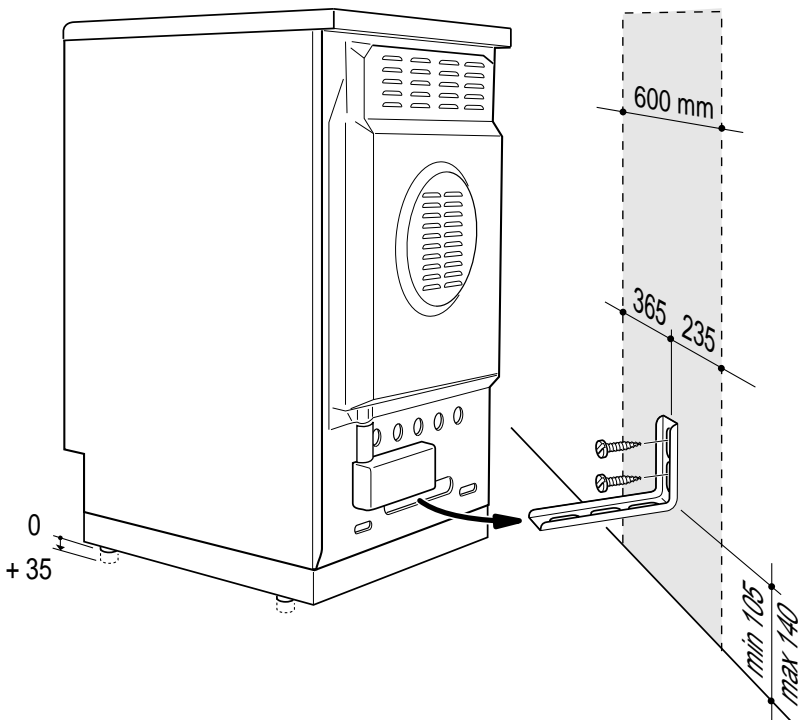

USE and CARE

CAUTION:

- This appliance must be used only for the task it has explicitly been designed for, that is for cooking foodstuffs. Any other form of usage is to be considered as inappropriate and therefore dangerous.
- Do NOT place combustible materials or products on this appliance at any time.
- Do NOT spray aerosols in the vicinity of this appliance while it is in use.
- Before using for the first time, clean the cooktop with warm soapy water. We recommend that you run each plate individually for several minutes. To do this, place a saucepan of cold water on each plate in turn, and bring the water to the boil. This should give enough time for the plates to burn off properly. During this procedure the room should be well ventilated, as there may be an emission of smoke and a slight odour.

SLIDING SHELVES

- They facilitate the insertion and removal shelves during cooking. These shelves support all accessories and the dishwarmer safe.
- The shelves block when pulled to the maximum position.
- The sliding shelves can be removed easily by lifting slightly and detaching them from the oven walls.
- Removing the sliding shelves improves access to the oven ceiling for cleaning (after the grill heating element has been lowered).

Figure 3A

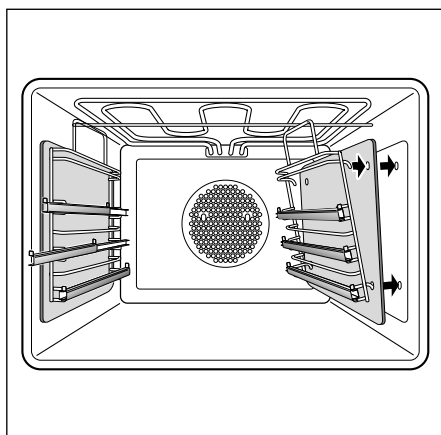
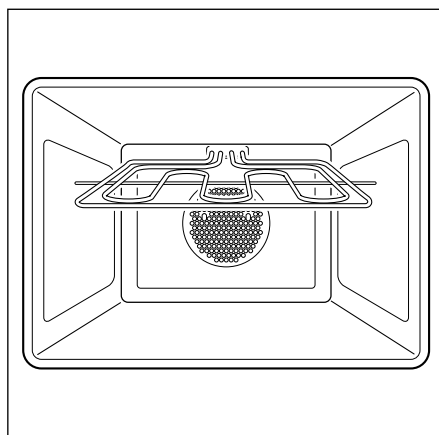





Figure 3B



USING THE OVEN FOR THE FIRST TIME

- Slide off the sliding shelves and the catalytic liners to the oven wall as in Fig. 3A. The grill is secured to the rear wall of the oven on a hinge system that allows it to be lowered to allow proper access when cleaning the oven ceiling (fig. 3B).
- Clean the inside of the oven with a cloth soaked in water and neutral detergent and dry thoroughly.
- Slide in the catalytic liners and sliding shelves on the oven wall as in Fig. 3A.
- Slide in the grease filter on the back of the oven as in Fig. 4.
- Position the shelf and tray on the sliding shelves (fig. 3C).
- To eliminate traces of grease in manufacture it is necessary to pre-heat the oven at the maximum temperature.
 - For 60 minutes in the  position, for 30 minutes in the  position and for another 15 minutes in the  position.

GREASE FILTER

- A special screen is provided at the back of the oven to catch grease particles, mainly when meat is being roasted (fig. 4).
- When backing pastry etc. this filter should be removed.
- Always clean the filter after cooking as any solid residues on it might adversely affect the oven performance.

Figure 3C

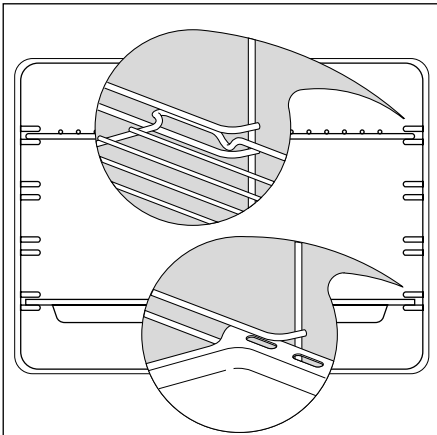
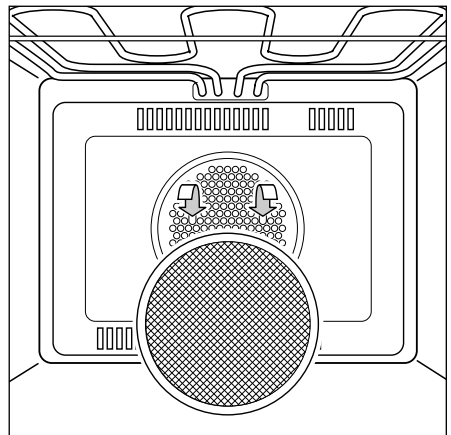
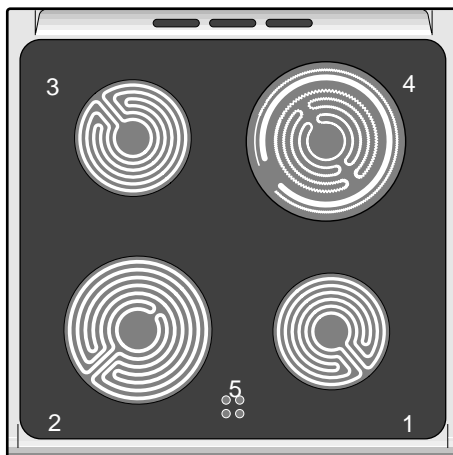

Figure 4



VITROCERAMIC HOB

Figure 5



COOKING ZONES

1. Radiant hotplate	Ø 145	1200 W
2. Radiant hotplate	Ø 180	1700 W
3. Radiant hotplate	Ø 145	1200 W
4. Halogen hotplate	Ø 210	2200 W
5. Residual indicators		

Attention: Detach the appliance from the mains if the ceramic hob is cracked.

The ceramic surface of the hob allows a fast transmission of heat in the vertical direction, from the heating elements underneath the ceramic glass to the pans set upon it.

The heat does not spread in the horizontal direction, so that the glass stays "cool" at only a few centimeters from the cooking plate.

The 4 cooking plates are shown by dark disks on the ceramic surface.

TYPE OF HOTPLATES

RADIANT HOTPLATES:

- Each radiant plate is comprised of the elements which can be controlled either separately or together using the 7 position switches fig. 6.
- The temperature control knobs must be turned anti clockwise. When a plate is on, the indicator light on the control panel will be lit.
- When the temperature of any plate is over 60°C the residual heat warning light at the front of the hob will light up.
- This light will stay on even after the hob has been switched off to show that the hob surface is still hot.
- This light will automatically switch off when the surface temperature falls below 60°C.

Figure 6

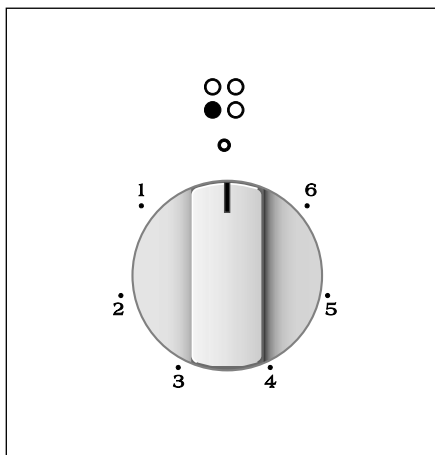

HALOGEN HOTPLATE

Incorporating 1 halogen lamp and 2 heating elements (fig. 8 - type A or fig. 9-type B).

Instantly reaches the working temperature.
Controlled by energy regulator switch.

HALOGEN HOTPLATE CONTROL KNOB

The halogen hotplate is controlled by a energy regulator switch (fig. 7).
The heat power of the halogen hotplate can be adjusted within steps from "0" to its max "12".

Figure 7

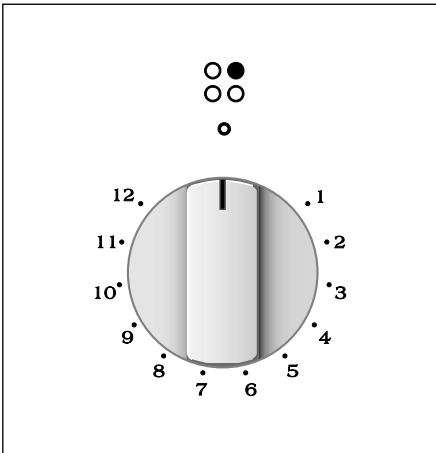
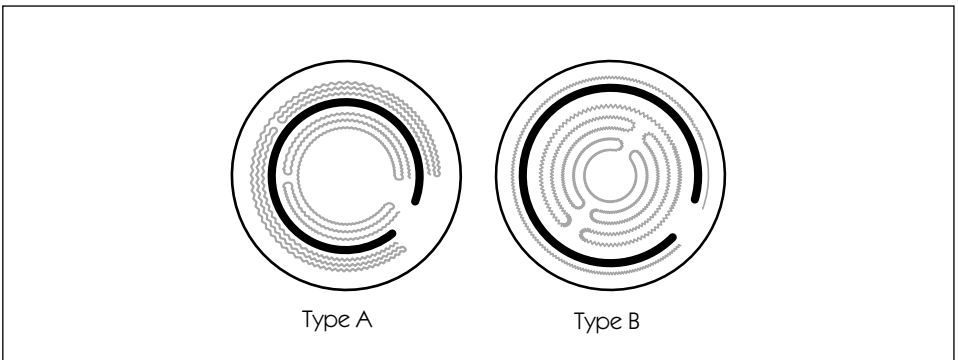

Figure 8

Figure 9



Type A

Type B

SAFETY HINTS:

1. Never put cooking foil or plastic materials on the ceramic surface when the hob is hot.
 2. Make sure that the hob is clean before you use it.
 3. Remember that the plates will remain hot for approximately half an hour after the plate has been switched off.
 4. Before you switch the hob on, make sure that you know which knob controls the required hot plate. We advise you to set the pan over the cooking plate before switching it on.
 5. Pan handles should never stand beyond the kitchen work top. This will ensure that children cannot reach them.
 6. Do not use pans with rough bases as these may scratch the hob surface.
 7. DO NOT use the hob if the glass surface is broken or cracked in any way. Please disconnect the appliance from the mains and call the After-Sales Service.
 8. Do not lean over the cooking plate when in use.
 9. Follow the cleaning instructions carefully.
 10. Always ensure that the base of your saucepan is clean and dry before placing on the hob.
 11. Never use the glass surface for storage.
- Do not stare at the light of the halogen hotplate.**

WARNING:

- HOBBS BECOME VERY HOT WITH USE, AND RETAIN THEIR HEAT FOR A LONG TIME AFTER COOKING HAS FINISHED. CHILDREN SHOULD BE SUPERVISED AT ALL TIMES AND BE PREVENTED FROM TOUCHING THE HOT SURFACES UNTIL SUCH TIME AS THE APPLIANCE HAS COOLED.

RESIDUAL HEAT INDICATOR

The hob also features 4 warning lamps which are wired to the corresponding plate. When the temperature of a cooking plate is over 60°C, the relevant warning lamp is also lit-up to warn of heat on the surface of the hob.

This lamp also stays on after the cooking plate has been switched off to show that the hob surface is still hot.

This residual heat lasts for a rather long time after the cooking plate has been switched off.

During this spell of time you should avoid touching the hob surface over the cooking plate; please pay special attention to children.

The lamp will switch off automatically as soon as the surface temperature of the cooking plate falls below 60°C.

Cooking hints:

- To reduce the cooking time, you can turn the control knob to the max when you switch the plate on.

After a short time you will set the control knob to the required position for the cooking.

- You should use pots and pans with flat bases (pans with the test mark for glass-ceramic hobs are available from specialist shops).

The diameter of the pan should match that of the cooking plate (or be slightly bigger) to make the most of the energy.

- Since the cooking surface stays hot for a certain time after the plate has been switched off, you can switch it off 5 or 10 minutes before the end of the cooking.

The residual heat of the hob will complete the cooking.

- To save electricity, use pan lids whenever possible.
- **Never cook the food directly on the glass ceramic cooktop, but in special pans or containers.**

COOKING HINTS:

Switch Position Quick-light star hotplates	Switch Position Halogen hotplates	Type of Cooking
0	0	Switched off
1 - 2	1 - 2	For melting (butter, chocolate) - Keeping food warm
2	2 - 3 - 4	To keep food hot to heat small quantities of liquid (sauces, etc.)
3	4 - 5 - 6	To heat larger quantities e.g. Soups, Sauces, Vegetables
3 - 4	6 - 7	Slow boiling e.g. Spaghetti, Soups, Stews, Potatoes
4	7 - 8	Gently Frying
4 - 5	8 - 9 - 10	Browning Meats, Frying Fish, Omelettes
6	11 - 12	Fast frying Steaks, etc.

- Please note that these are only guidelines, you will quickly learn from experience which setting is correct for your needs.

ECONOMIC COOKING

- The ceramic glass retains heat, so you may find that you can switch off the heat 5 minutes before you finish cooking.
- To reduce the cooking time, the plate can be set to the maximum setting at the beginning. It can then be reduced later.

COOKWARE:

It is very important that the pans used on the hobs are made of a suitable material and have the correct base as follows:

- The base should be flat and smooth.
- Any rough part on the pan base could scratch the hob surface.
- Choose pans which are the same size as the hotplates and with bases that are as non reflective as possible. eg. dull and dark.

Only pans recommended for use on ceramic hobs should be used.
Pans made of the following materials can cause problems:

Cast Iron ■ The base may be rough which will scratch the hob.

Toughened Glass ■ If the pans become too hot, the hob may overheat causing the safety cut out to operate too frequently thus reducing the cooking efficiency.

Copper ■ Can easily distort and will therefore not form a good contact between base and hob which will result in uneven cooking.

MULTIFUNCTION OVEN

Figure 10

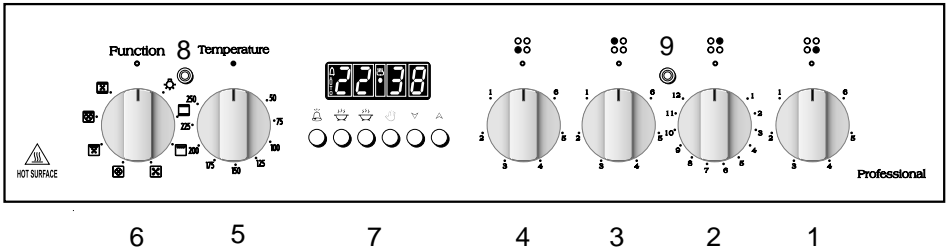

CONTROL PANEL - Controls description

1. Front right hotplate control knob
2. Rear right hotplate control knob
3. Rear left hotplate control knob
4. Front left hotplate control knob
5. Multifunction oven thermostat knob
6. Multifunction oven switch knob
7. Electronic programmer

Pilot lamps:

8. Oven thermostat indicator light
9. Indicator light

GENERAL FEATURES

With your new Multi-Function oven it is possible to cook a variety of food using the 7 different cooking functions.

These 7 functions are obtained using a combination of the 4 different heating elements plus a defrost function using the fan only.

Please note: This appliance incorporates a safety cooling fan which you will hear operating whenever the oven or grill are in use. This fan is to reduce the external temperature of the appliance and cool the internal components.

OPERATING PRINCIPLES

Heating and cooking in the MULTI-FUNCTION oven are obtained in the following ways:

- a. by normal convection
The heat is produced by the upper and lower heating elements.
- b. by forced convection
The fan in the oven sucks the air that is contained within the oven housing at the rear of the oven and forced it over the circular heating element. The hot air envelops the food in the oven giving faster and more even cooking before it is sucked back into the housing to repeat the cycle. It is possible to cook several dishes simultaneously due to the even distribution of heat within the oven.
- c. by forced semi-convection
The heat produced by the top and bottom heating elements is distributed throughout the oven by the fan.
- d. by radiat heat
The food is grilled by the infra red grill element.
- e. by radiat heat and ventilation
The food is grilled by the grill element is distributed throughout the oven
- f. by ventilation
The food is defrosted by using the fan only function without heat.

Figure 11

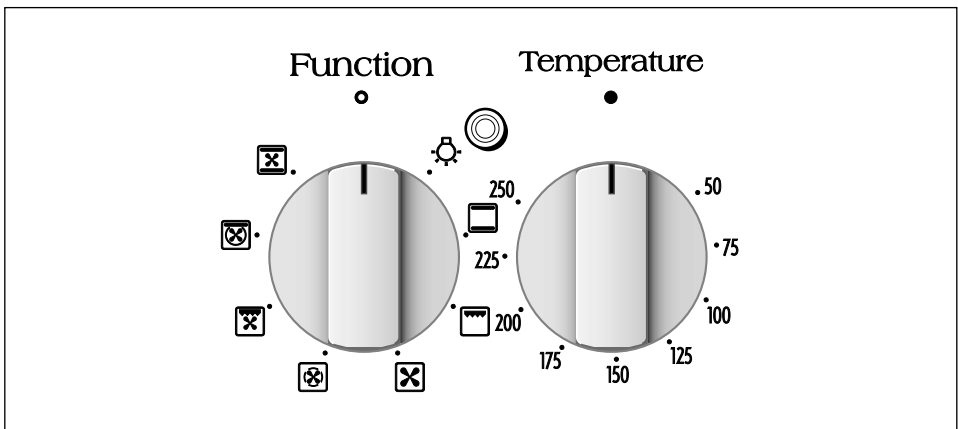

FUNCTION SELECTOR KNOB

Rotate the knob clockwise to set the oven for one of the following functions.

THERMOSTAT KNOB

This only sets the cooking temperature and does not switch the oven on. Rotate clockwise until the required temperature is reached (from 50 to 250°C).



OVEN LIGHT

By setting the knob to this position, only the oven light comes on (15 W). It remains on in all the cooking modes.



TRADITIONAL BAKE

The upper and lower heating elements come on. The heat being dispersed by natural convection. The temperature range must be set between 50°C and 250°C using thermostat.

The oven must be preheated before cooking.

Ideal for:

Food that requires the same degree of cooking both inside and out, for example roasts, spare pork ribs, meringues etc.



GRILLING

The infrared grill element at the top of the oven comes on. The heat is dispersed by radiation.

Use with the **oven door closed** and the thermostat knob to position **225°C** for max 15 minutes, then to position **175°C**.

For cooking hints, see the chapter "USE OF THE GRILL".

Recommended for:

Intense grilling, browning, cooking au gratin and toasting etc.

It is recommended that you do not grill for longer than 30 minutes at any one time.

Attention: the oven door becomes very hot during operation.

Keep children away.



DEFROST

Only the oven fan comes on. Use with the thermostat knob set to "●" - other temperature have no effect. The food is thawed by ventilation without heating.

Ideal for:

Quick thawing of frozen foods; one kg requires approximately 1 hour.

Thawing times vary according to the quantity and type of food to be thawed.



FAN FORCED

The circular element and fan come on. The heat is dispersed by forced convection and the temperature can be varied to between 50° and 250°C via the thermostat knob. The oven does not require preheating.

Recommended for:

Food which has to be well-cooked outside and soft or rosy inside, for example lasagne, lamb, roast beef, whole fish etc.



FAN GRILL

Both the grill and the fan come on. Most of the cooking is done by grilling and then the hot air circulated around the oven. The oven door should be kept **closed**.

The temperature can be set between 50°C and 175°C maximum.

The oven should be preheated for 5 minutes before cooking. For further cooking hints see "GRILLING AND COOKING AU GRATIN" (page 21).

Ideal for:

Quick sealing in of food juices for example such as hamburger, chicken pieces, chops.

It is recommended that you do not grill for longer than 30 minutes at any one time.

Attention: the oven door becomes very hot during operation.

Keep children away.



MAINTAINING TEMPERATURE AFTER COOKING OR SLOWLY HEATING FOODS

The upper element, the circular element and the fan come on.

The heat is circulated by forced convection with greater intensity in the upper part.

The temperature can be set to between 50° and 150°C via the thermostat knob.

Recommended for:

Keeping food warm after any type of cooking. Slow heating of cooked food.



MULTI-FUNCTION

The upper and lower heating elements come on and the fan come on - the heat from the element being circulated by the fan.

The temperature range can be set to between 50° and 250°C using the thermostat.

Idea for:

Large bulky quantities of food that require even cooking throughout for example large roasts, turkey, roast turkey, cakes etc.

COOKING ADVICE

STERILIZATION

Sterilization of foods to be conserved, in full and hermetically sealed jars, is done in the following way:

- Set the switch to position .
- Set the thermostat knob to position 185 °C and preheat the oven.
- Fill the dripping pan with hot water.
- Set the jars onto the dripping pan making sure they do not touch each other and the door and set the thermostat knob to position 135 °C.

When sterilization has begun, that is, when the contents of the jars start to bubble, turn off the oven and let cool.

Check your recycle book for full instructions.

SIMULTANEOUS COOKING OF DIFFERENT FOODS

The oven set on position  can cook several different foods together. Foods as diverse as fish and cakes can be cooked together without the cross transference of flavours. This is because the fats and cooking smell that would normally be deposited on the different foods are oxidised and are not absorbed by the foods. The cooking temperature of the foods, however must be within 20°-25°C of each other. The food with the longest cooking time will be put into the oven first and the other foods are added as necessary according to their cooking times.

GRILLING AND “AU GRATIN”

Grilling may be done without the roasting jack on position  of the switch, because the hot air completely envelops the food that is to be cooked.

Set the thermostat to position 175°C and after having preheated the oven, simply place the food on the rack. Close the door and let the oven operate with the thermostat on position **175°C**, until grilling is done. Adding a few dabs of butter before the end of the cooking time gives the golden “au gratin” effect.

It is recommended that you do not grill for longer than 30 minutes at any one time.

ROASTING

To obtain classical roasting, it is necessary to remember:

- that it is advisable to maintain a temperature between 180° and 200 °C.
- that the cooking time depends on the quantity and the type of foods.

USE OF THE GRILL

Preheat the oven for about 5 minutes with the door closed.

Introduce the food to be cooked, positioning the rack as close to the grill as possible.

The dripping pan should be placed under the rack to catch the cooking juices and fats.

Do not grill for longer than 30 minutes at any one time.

RECOMMENDED COOKING TEMPERATURE

Food	°C	°F	Gas Mark	Shelf Position *	Cooking Time (approx)
CAKES					
Victoria sandwich	190	375	5	2 or 3	20-25 mins
Small cakes/buns	190	375	5	1 and 2	15-20 mins
Maidera cake	180	350	4	2 or 3	20 mins
Fruit cake	170	325	3	3	1 ³ / ₄ hours
Rich fruit cake	150	300	2	3 or 4	2 ¹ / ₂ hours
Scones	225	425	8-9	2	8-10 mins
PASTRY					
Puff	225	425	8-9	2	10-20 mins
Short crust	200	400	6	2	20-30 mins
Plate tarts	200-210	400-410	6	1 or 2	30-35 mins
Quiches and flans	200-210	400-410	6	1 or 2	40-45 mins
YEAST					
Bread loaf	225	425	7-8	2	35-55 mins
Bread rolls	220	425	7	1 or 2	15-20 mins
Pizza dough	230	450	8	2	20 mins
ROAST MEAT					
Beef – Medium	190	375	5	2 or 3	20 mins/lb + 20 mins
Lamb	190	375	5	2 or 3	25-30 mins/b + 25 mins
Pork	190-200	375-400	5-7	2 or 3	30 mins/lb + 30 mins
Veal	190	375	5	2 or 3	30 mins/b + 30 mins
Chicken	190	375	5	2 or 3	30 mins/b + 30 mins
Turkey up to 10lb	180	350	4	2 or 3	18-20 mins/b + 20 mins
Stews/casseroles	150-170	300-325	2-3	2 or 3	1 ¹ / ₂ 2 hours

N.B. For fan ovens reduce the temperature by 10-20°C. For any dish taking one hour or over to cook, reduce the cooking time by 10 minutes per hour.







* Shelf positions have been counted from the top of the oven to the base. A fan oven creates more even temperature throughout, therefore the shelf positions are not as critical.

ELECTRONIC PROGRAMMER

The electronic programmer is a device which groups together the following functions:

- 24 hours clock with illuminated display
- Timer (up to 23 hours and 59 minutes)
- Program for automatic oven cooking
- Program for semi-automatic oven cooking.

Description of the buttons:

-  Timer
-  Cooking time
-  End of cooking time
-  Manual position and cancellation of the inserted cooking program
-  Plus function to increase the number shown on the display
-  Minus function to decrease the number shown on the display or to change the buzzer frequency

Description of the illuminated symbols:

AUTO -flashing - Programmer in automatic position but not programmed

AUTO - always illuminated - Programmer in automatic position with program inserted.

 Automatic cooking taking place

 Timer in operation

 and **AUTO** - flashing - Program error.

(The time of day lies between the calculated cooking start and end time).

Note:

Select a function by the respective button and, in 5 seconds, set the required time with the  /  buttons ("one-hand" operation).

A power cut makes the clock go to zero and cancels the set programs.

Figure 12

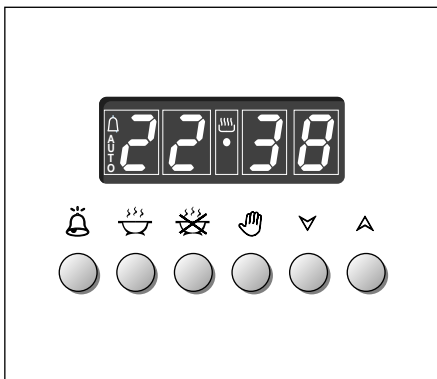
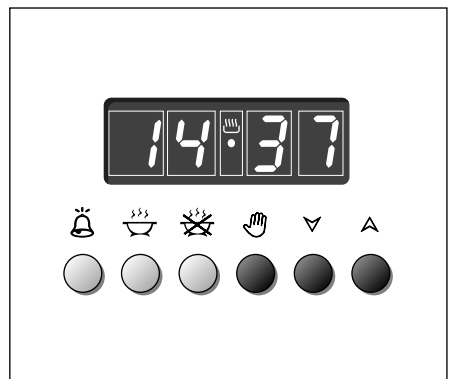









Figure 13



ELECTRONIC CLOCK (fig. 13)



The programmer is equipped with an electronic clock with lighted numbers which indicates hours and minutes. Upon immediate connection of the oven or after a power cut, three zeros will flash on the programmer panel.

To set the hour it is necessary to push the  button and then the  or  button until you have set the exact hour (fig. 13).

Another way is to simultaneously push the   two buttons and at the same time push the  or  button.

Nota: Changing the hour button deletes any cooking program.

NORMAL COOKING WITHOUT THE USE OF THE PROGRAMMER

To manually use the oven, that is, without the aid of the programmer, it is necessary to cancel the flashing AUTO by pushing the button  (AUTO will be switched off and the symbol  will go on - Fig. 14).

Attention: If the **AUTO** symbol is steady a cooking program has already been programmed, by pushing the button  you have cancelled of the program and the switched to manual.

If the oven is switch on, you must switch off manually.

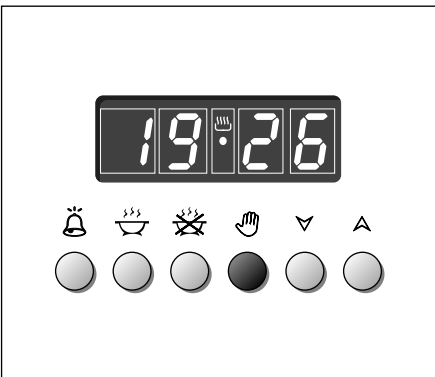

Figure 14





ELECTRONIC TIMER

The timer program consists only of a buzzer which may be set for a maximum period of 23 hours and 59 minutes.

If the **AUTO** flashing push the  button.

To set the time, push the  button and the  or  until you obtain the desired time in the panel (fig. 15).

Having finished the setting, the clock hour will appear on the panel and the  symbol will be lighted.

The countdown will start immediately and may be seen at any moment on the panel by simply pressing the button .

At the end of the time, the  symbol will be switched off and an intermittent buzzer will go off; this can be stopped by pressing any of the buttons.

SETTING THE FREQUENCY OF THE AUDIBLE SIGNAL

The selection from 3 possibilities of sound can be made by pressing the  button.

Figure 15







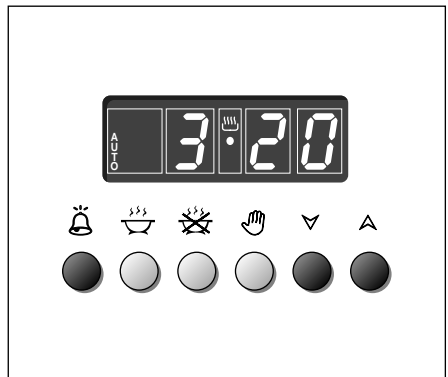



AUTOMATIC OVEN COOKING

To cook food automatically in the oven, it is necessary to:

1. Set the length of the cooking time
2. Set the end of the cooking time
3. Set the temperature and the oven cooking program.

These operations are done in the following way:

1. Set the length of the cooking time by pushing the  button and the  button to advance, or  to go back if you have passed the desired time (fig. 16). The **AUTO** and the  symbol will be on.
2. Set the end of the cooking time by pressing the  button (the cooking time already added to the clock time will appear), and the  button (fig. 26); if you pass the desired time you may get back by pushing the  button.

After this setting, the  symbol will go off. If after this setting, the **AUTO** flash on the panel and a buzzer gives off, it means there was an error in the programming.

In this case, modify the end of cooking time or the cooking time itself by following again the above mentioned instructions.

3. Set the temperature and the cooking program by using the switch and thermostat knobs of the oven (see specific chapters).

Now the oven is programmed and everything will work automatically, that is the oven will turn on at the right moment to end the cooking at the established hour.

During cooking, the  symbol remains on.

By pushing the  button you can see the time that remains until the end of cooking.

The cooking program may be cancelled in any moment by pushing .

At the end of the cooking time the oven will turn off automatically, the  symbol will turn off, **AUTO** will flash and a buzzer will sound, which can be turned off by pushing any of the buttons.

Turn the switch and thermostat knobs to zero and put the programmer onto "manual" by pressing the  button.

Attention: A power cut makes the clock go to zero and cancels the set programs.

After a power cut, three zeros will flash on the panel.

Figure 16

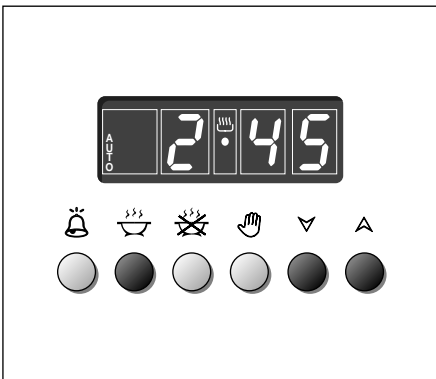
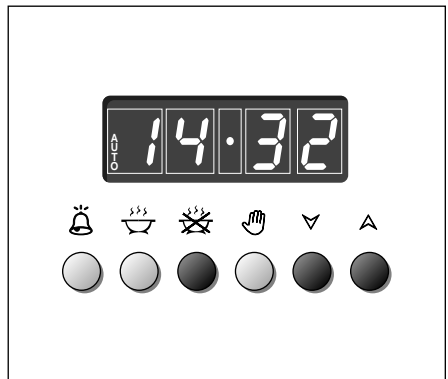





Figure 17







SEMI - AUTOMATIC COOKING

This function is only used to set the END of the cooking time of the oven. There are two ways of setting this function.



1. Set the length of the cooking time by pushing the  button and the  button to advance, or  to go backwards (Fig. 18). This sets the desired "stop" time.

or

2. Set the end of the cooking time by pushing the  button and the  button to advance, or  to go backwards if you have passed the desired time (Fig. 19).

AUTO and the  symbol will be on. Then set the temperature and the cooking program using the oven switch and thermostat knob (see relevant sections for details).

The oven is switched on and it will be switched off automatically at the end of the desired time.

During cooking, the  symbol remains on and by pressing the button  you can see the time that remains till the end of the cooking. The cooking time can be cancelled at any moment by pushing the  button.

At the end of the cooking, the  symbol will turn off, the **AUTO** will flash and a buzzer will sound. The buzzer can be cancelled by pressing any of the buttons.

Turn the switch and thermostat knobs to zero and reset the programmer back to "manual" by pressing the  button.

Figure 18

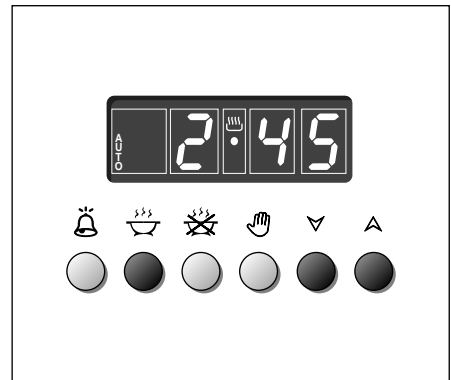
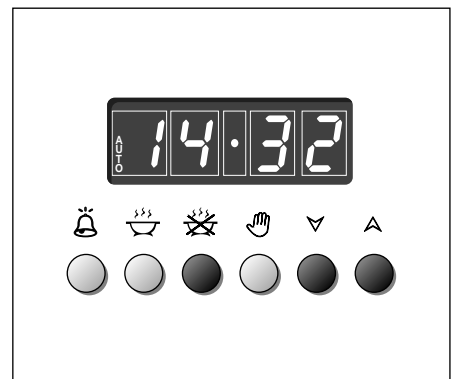

Figure 19



Cleaning and Maintenance

GENERAL ADVICE

- Before you begin cleaning, you must ensure that the appliance is switched off.
- It is advisable to clean when the appliance is cold and especially when cleaning the enamelled parts.
- Avoid leaving alkaline or acidic substances (lemon juice, vinegar, etc.) on the surfaces.
- Avoid using cleaning products with a chlorine or acidic base.
- Do not use a steam cleaner because the moisture can get into the appliance thus make it unsafe.

VITROCERAMIC HOB

- Remove any encrustation using a special scraper which can be bought (Fig. 20).
- Remove dust using a damp cloth.
- Detergents can be used as long as they are not abrasive or corrosive.
- All residues of detergent must be eliminated with a damp cloth.
- Keep all objects that could be melted by the heat away from the top: plastic objects, aluminium foil, sugar or sugary products.
- If an object melts on the top, remove immediately (while the top is still hot) using the scraper to avoid permanent damage to the pyroceram surface.
- Avoid using knives and pointed objects as they could damage the surface of the top.
- Also avoid using abrasive sponges or wire wool which can permanently scratch the pyroceram surface.

Figure 20

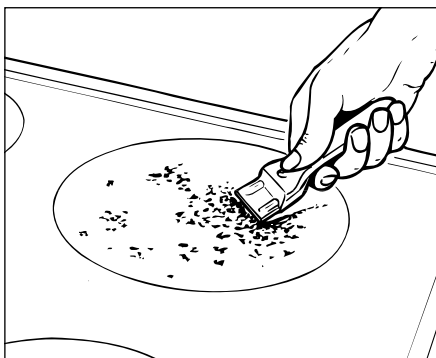

ENAMELLED PARTS

- All of the enamelled parts must be washed only with a sponge and soapy water or with non-abrasive products.
- Dry, preferably, with deer skin.

STAINLESS STEEL SURFACE

- The stainless steel front panels on this cooker (facia, oven door, drawer or storage compartment) are protected by a finger-print proof lacquer. To avoid damaging this lacquer, do not clean the stainless steel with abrasive cleaners or abrasive cloths or scouring pads.

ONLY SOAP/WARM WATER MUST BE USED TO CLEAN THE STAINLESS STEEL SURFACES.

OVEN

- The oven with smooth enamel must be cleaned after every use, using suitable products.
- Please note that after using the oven for 30 minutes on the highest temperature eliminates most grime reducing it to ashes.
- Do not use abrasive substances to clean the oven.

Advice for use and maintenance of catalytic panels

The catalytic panels are covered with special microporous enamel which absorbs and does away with oil and fat splashes during normal baking over 200°C. If, after cooking very fatty foods, the panels remain dirty, operate the oven "idling" on max temperature for about 30 minutes. These panels do not require to be cleaned, however it is advised to periodically remove them from the oven (at least the side panels) and to wash them with tepid soapy water and then wipe off with a soft cloth.

DO NOT CLEAN OR WASH THEM WITH ABRASIVE PRODUCTS OR WITH PRODUCTS CONTAINING ACIDS OR ALKALIS.

The side panels are reversible and when the catalytic microporous enamel degrades, they can be turned to the other side.

GRILL HEATING ELEMENT

- The heating element is self-cleaning and does not require maintenance. The grill is secured to the rear wall of the oven on a hinge system that allows it to be lowered to allow proper access when cleaning the oven ceiling.

Before any cleaning or maintenance operation, disconnect the cooker from mains power supply.

GREASE FILTER

Clean the filter after any cooking!

The grease filter can be removed for cleaning and should be washed regularly in hot soapy water (fig. 4 at page 4).

Always dry the filter properly before fitting it back into the oven.

OVEN DOOR AND DRAWER

The internal glass of the oven door can be easily removed for cleaning by unscrewing the two lateral fixing screws (fig. 21).

The drawer (fig. 22) comes out like a normal drawer.

Attention: Do not store flammable material in the oven, or the accessory drawer.

REPLACING THE OVEN LIGHT

Before any maintenance is started involving electrical parts of the appliance, it must be disconnected from the power supply.

The bulb must be a type resistant to high temperatures (300° C).

Figure 21

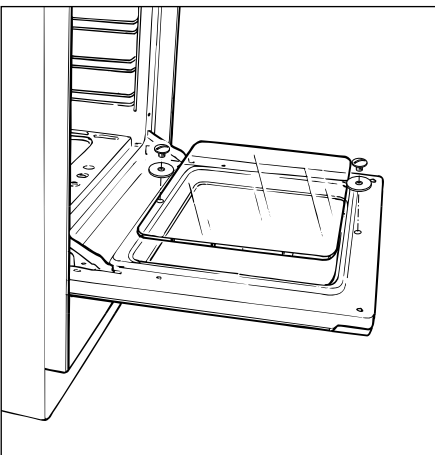
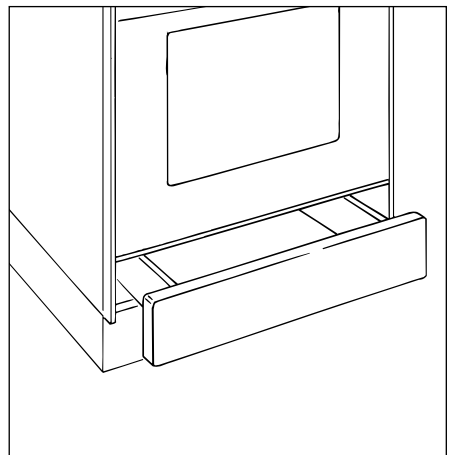

Figure 22



REMOVING THE OVEN DOOR - Type "A"

The oven door can easily be removed as follows:

- Open the door to the full extent (fig. 24).
- Attach the retaining rings to the hooks on the left and right hinges (fig. 25).
- Hold the door as shown in fig. 23.
- Gently close the door and withdraw the lower hinge pins from their location (fig. 26).
- Withdraw the upper hinge pins from their location (fig. 27).
- Rest the door on a soft surface.
- To replace the door, repeat the above steps in reverse order.

Figure 24

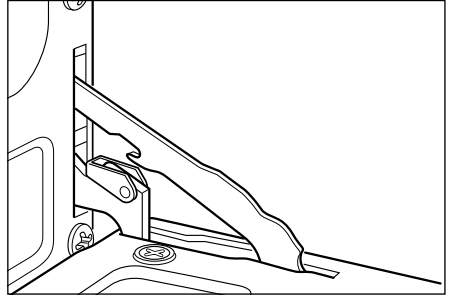

Figure 25

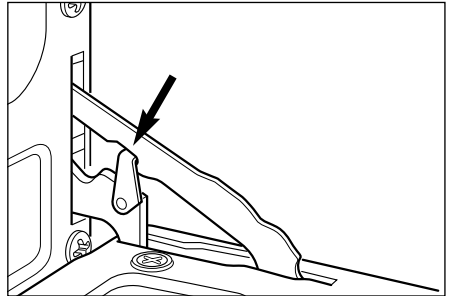

Figure 26

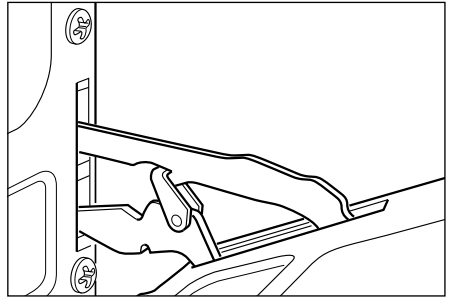

Figure 27

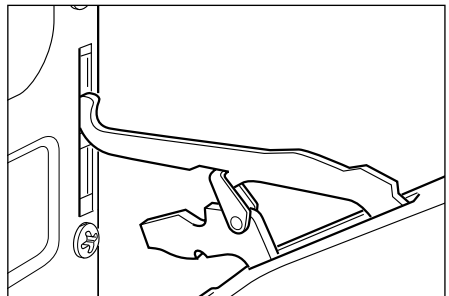
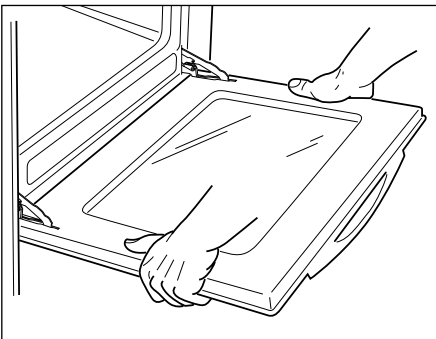

Figure 23



REMOVING THE OVEN DOOR - Type "B"

To facilitate oven cleaning, it is possible to remove the door.

Please follow the instructions carefully:

- Open the door completely.
- Push down the lever "L" (fig. 28) and, keeping it in this position, slowly close the door in order to block the hinge.
- Grip the door (as indicated in fig. 29) and, while closing it, release the two hinges as shown in fig. 30.

Figure 28

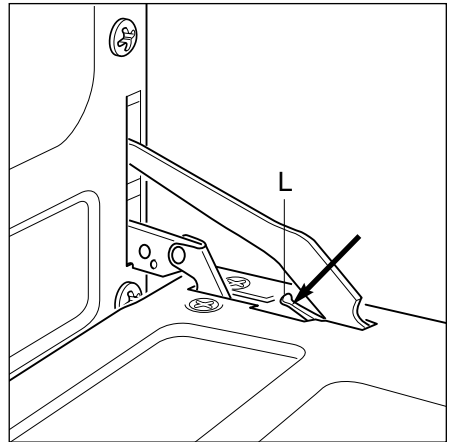
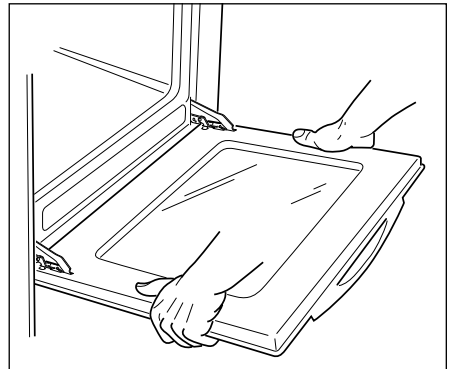

Figure 29



DOOR ASSEMBLY

- Grip the door with your hands placed near the hinges and raise the levers "H" with your forefingers (fig. 30)
- Insert the hinges in their position until levers "H" are hooked.
- Open the door completely to obtain the release of levers "L".

Figure 30

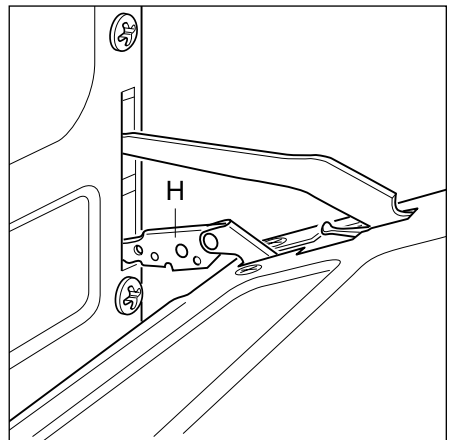

LEVELLING

The cooker is equipped with a 4 levelling feet which must be fitted to the base of the cooker in the following manner:

- Place the cooker on its back as shown in the figure 31.
- Screw the 4 leveling feet to the cooker.
- Stand the cooker and levelling it by screwing or unscrewing the feet with a spanner.

Figure 31

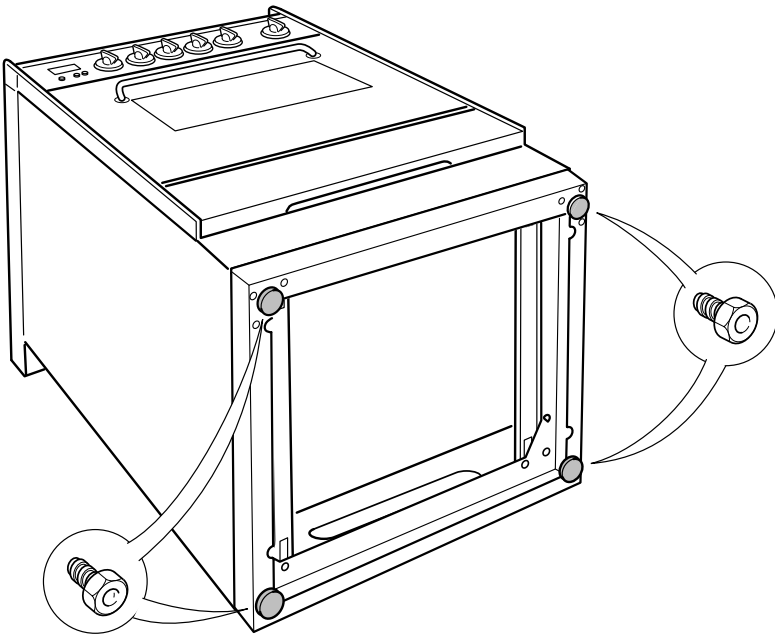

WIRING DIAGRAM

Figure 32

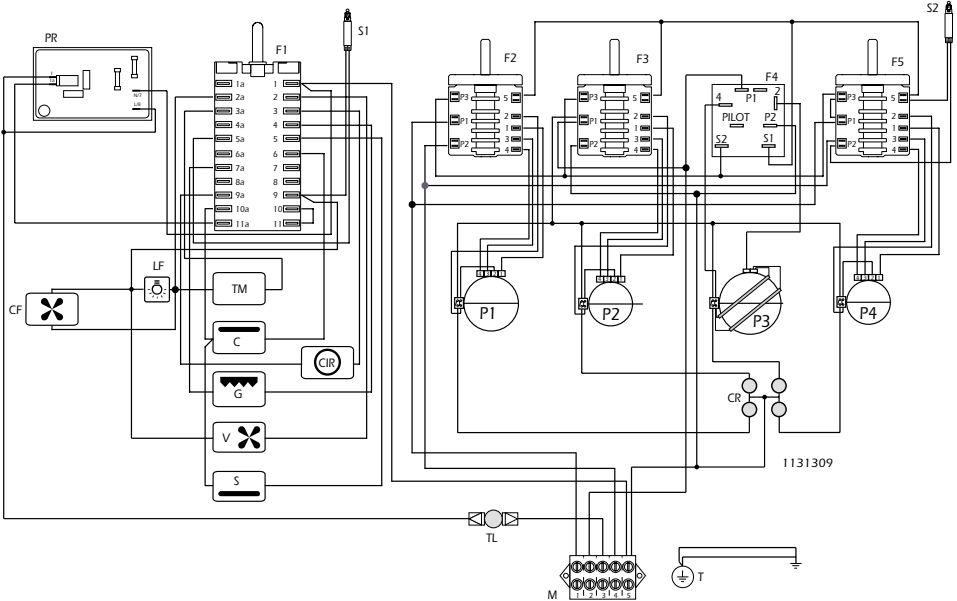

ELECTRIC DIAGRAM KEY

F1	Oven switch
F2/3/5	Radiant heaters switches
F4	Halogen regulator
LF	Oven lamp
TM	Oven thermostat
TL	Oven thermolimiter
PR	Programmer
C	Top element
G	Grill element
S	Bottom element
V	Fan
CIR	Circular element
CR	Residual heat lamps
S1	Thermostat pilot lamp
S2	Radiant heaters pilot lamp
P1/P2/P4	Radiant heaters
P3	Halogen heater
CF	Cooling fan
M	Terminal block
T	Earth plant

Descriptions and illustrations in this booklet are given as simply indicative. The manufacturer reserves the right, considering the characteristics of the models described here, at any time and without notice, to make eventual necessary modifications for their construction or for commercial needs.



Living innovation

cod. 1102328 B1

Free Manuals Download Website

<http://myh66.com>

<http://usermanuals.us>

<http://www.somanuals.com>

<http://www.4manuals.cc>

<http://www.manual-lib.com>

<http://www.404manual.com>

<http://www.luxmanual.com>

<http://aubethermostatmanual.com>

Golf course search by state

<http://golfingnear.com>

Email search by domain

<http://emailbydomain.com>

Auto manuals search

<http://auto.somanuals.com>

TV manuals search

<http://tv.somanuals.com>