

ELECTRIC OVEN FOUR ÉLECTRIQUE HORNO ELÉCTRICO

E02058/E02060/R02050/R02058

Register this product on-line and receive a free trial issue of Cook's Illustrated. Visit www.delonghiregistration.com.
Visit www.delonghi.com for a list of service centers near you. (U.S. and Canada Only)

Enregistrez ce produit en ligne et recevez un numéro gratuit de Cook's Illustrated. Visitez www.delonghiregistration.com.
Visitez www.delonghi.com pour y voir une liste des centres de réparation proches de chez vous. (É.-U. et Canada uniquement)

Registre este producto en línea y reciba un ejemplar gratis de Cook's Illustrated. Visite www.delonghiregistration.com.
Visite www.delonghi.com para ver la lista de centros de servicios cercanos a usted. (Solamente en los Estados Unidos y Canada)

Instructions for use

Keep these instructions

Mode d'emploi

Conservez cette notice

Instrucciones para el uso

Repase y guarde estas instrucciones

Lea cuidadosamente este instructivo antes de usar su aparato.

ELECTRIC CHARACTERISTICS / CARACTÉRISTIQUES ÉLECTRIQUES /
CARACTERISTICAS ELECTRICAS:
120 V~ 60 Hz 1 300 W

ELECTRICAL CONNECTION

- Your product is equipped with a polarized alternating current line plug (a plug having one blade wider than the other). This plug will fit into the power outlet only one way. This is a safety feature. If you are unable to insert the plug fully into the outlet, try reversing the plug. If the plug should still fail to fit, contact your electrician to replace your obsolete outlet. Do not defeat the safety purpose of the polarized plug.
- Plug the cord into a 120 volt AC outlet.
- The cord length of this product has been selected to reduce the possibility of tangling in or tripping over a longer cord. If more cord length is needed, an extension cord may be used. It should be rated no less than 15 amps., 120 volts, and have Underwriters Laboratories/CSA listing.
- A six feet long, 15 amp. extension cord may be purchased from your local authorized service facility. When using a longer cord, be sure not to let it drape over the working area or dangle where someone could accidentally pull or trip over it.
- Handle the cord carefully for longer life; avoid jerking or straining the cord at the plug and appliance connections.

CONVERSION TABLE

°C	°F
95	200
107	225
120	250
135	275
150	300
163	325
177	350
190	375
205	400
218	425
233	450
246	475
260	500

DESCRIPTION OF THE APPLIANCE

- A Thermostat knob
- B Timer knob
- C Indicator light
- D Function selector knob
- E Glass door
- F Bottom heating element
- G Wire rack
- H Bake pan
- I Spit (if supplied)

- L Crumb tray
- M Top heating element
- N Interior light (if supplied)
- O Turnspit mount (if supplied)
- P Broil rack
- Q Spit handle (if supplied)

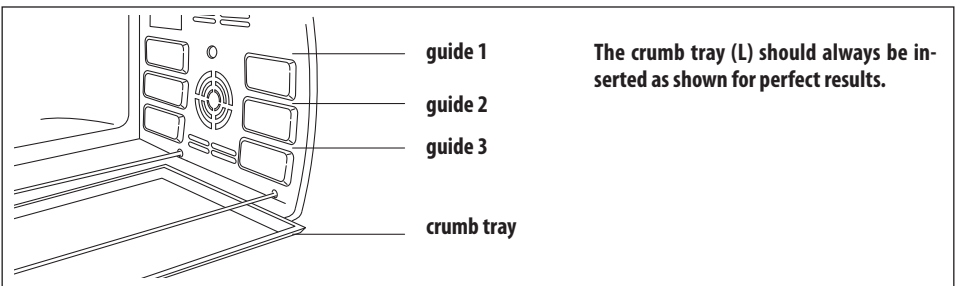
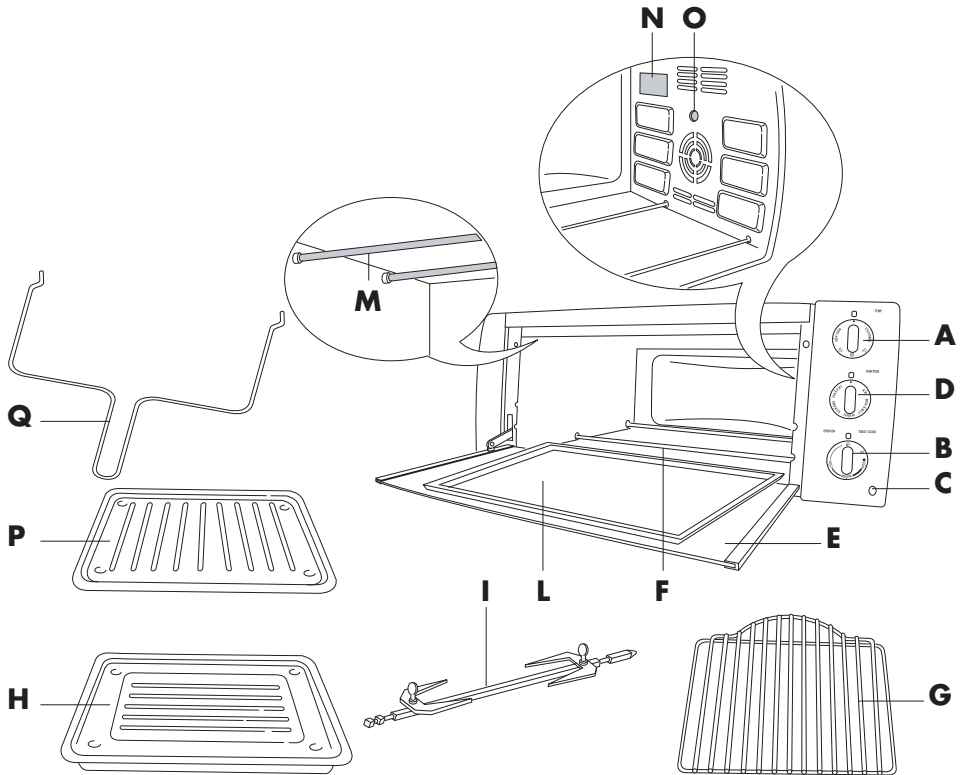

IMPORTANT WARNINGS

When using electrical appliances, a number of fundamental safety rules must be observed, including the following:

1. **READ ALL THE INSTRUCTIONS**
2. Do not touch the hot surfaces. Only use the knobs or handles to operate the appliance.
3. Before using the appliance, move it 5/10 cm (2") away from the wall and any other object that is on the same surface. Remove any objects located above the appliance. Do not use on surfaces that may be damaged by the heat.
4. To avoid electric shock, do not immerse the appliance in water or other liquid. See the instructions for cleaning.
5. If the appliance is used when children are around, pay careful attention to the metal walls of the oven and the door, which become very hot. The appliance must not be used by children without supervision. Make sure that children do not play with the appliance.
6. Unplug the appliance from the power outlet when this is not being used or before cleaning it. Always place the Timer knob in the "OFF" position and the thermostat knob in the "•" position before unplugging the appliance. Wait for the appliance to cool down before fitting or removing any parts.
7. Never operate the appliance with the cable or the plug damaged, if any malfunctions have occurred, or if the appliance has been damaged in any way. Take the appliance to the nearest authorized service center, which will inspect it and, if necessary, will adjust or repair it.
8. The use of accessories that are not recommended by the manufacturer may cause injuries.
9. Do not use outdoors.
10. Do not let the power cable hang from the counter or come into contact with hot surfaces.
11. Do not place the appliance above or near a gas or electric cooker.
12. Use maximum care when moving the appliance if it contains hot oil or other hot liquids.
13. If the plug heats up, contact a qualified electrician.
14. Do not use this appliance for purposes other than those it has been designed for.
15. Use maximum care when removing the bake pan or throwing out the hot fat.
16. Do not use metal sponges to clean the appliance, small particles may be detached that cause electric shocks.
17. To ensure the safe operation of the appliance, never introduce foods or utensils that are too large for the oven.
18. If the appliance, when operating, is covered by or comes into contact with flammable materials, such as curtains, fabrics or wall coverings etc., these may catch fire.
19. **WARNING: Never leave the appliance unattended when operating (especially when broiling or toasting).**
20. When broiling, the bake pan and the wire racks must be used as described in the instructions.
21. Extreme care must be taken when using containers made from materials other than glass, metal or ovenproof ceramics.
22. Do not place any objects in the oven when this is not being used, apart from the accessories recommended by the manufacturer.
23. Do not place any of the following materials into or on top of the oven: paper, cardboard, plastic and the like.
24. Do not cover parts of the oven with metal foil, to avoid overheating.
25. To switch the appliance off, turn the Timer knob to the "OFF" position and the thermostat knob to "•".







This product is designed exclusively for household use

KEEP THESE INSTRUCTIONS

WARNING: After having removed the appliance from its packaging, check that the door is intact.

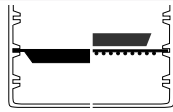
The door is made from glass and is therefore fragile. If it is visibly chipped, scored or scratched, it should be replaced. While using, cleaning or moving the appliance, avoid slamming or knocking the door. Do not pour cold liquid onto the glass while the appliance is hot.

SUMMARY TABLE

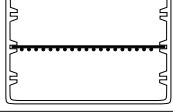
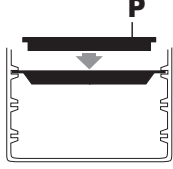
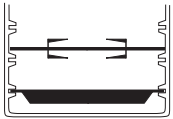
Program	Function selector knob position	Thermostat knob position	Wire rack and accessory position	Notes/Tips
Defrost <i>(only on some models)</i>	DEFROST	•	 1 2 3	Place the food directly on the wire rack inserted in the guide 2.
Delicate cooking	SLOW BAKE	250°F - TOAST/BROIL	 1 2 3	Use the bake pan inserted directly in the guide 3.
Keeping warm	BAKE	KEEP WARM	 1 2 3	Select this function to keep hot food warm. Do not hold food for longer than one hour or rewarm cold food at this setting. If food is not hot enough for serving turn temperature dial up.
Convection oven cooking <i>(only on some models)</i>	FAN & BAKE	250°F - TOAST/BROIL	 1 2 3 or  1 2 3	Ideal for lasagna, meat, pizza, cakes in general, foods that should be crunchy on the surface (“au gratin”) and bread. For details on how to use the accessories, refer to the tips in the table on pages 7-8.
Traditional oven cooking	BAKE	250°F - TOAST/BROIL	 1 2 3 or  1 2 3	Ideal for cooking stuffed vegetables, fish, plum cakes and small poultry. For details on how to use the accessories, refer to the table on page 8.
Toast	BAKE	TOAST/BROIL	 1 2 3	Ideal for toasting slices of bread.
Grilling	BROIL or BROIL & ROTIS.	TOAST/BROIL	 1 2 3	Put the broil rack (P) on the bake pan (H); place the food on the pan and insert into guide 1. Ideal for broiling meat, fish and vegetables.
Grilling with the turnspit <i>(only on some models)</i>	BROIL & ROTIS.	TOAST/BROIL	 1 2 3	Insert the spit in the turnspit mount (O) as described on page 10. Insert the bake pan in guide 3. Ideal for poultry, beef, etc.

USING THE CONTROLS

Thermostat knob (A)

Select the desired temperature, as follows:

- To defrost (*only on some models*) (see page 7):Thermostat knob in the “.” position.
- To keep food warm (see page 7):Thermostat knob in the “KEEP WARM” position.
- For convection oven cooking (*only on some models*)
or traditional oven cooking (see page 7-8):Thermostat knob from “250F-TOAST/BROIL.”.
- To toast (see page 9):Thermostat knob in the “TOAST/BROIL” position.
- For all types of grilling (see page 10):Thermostat knob in the “TOAST/BROIL” position.

Timer knob (B)

- To switch the oven on:Turn the knob to the “ON” position
- To set the toasting function:Select “LIGHT”, “MEDIUM” or “DARK”
- To switch the oven off:Return the knob to the “OFF” position.

Function selector knob (D)

This knob is used to select the cooking functions available, which are:

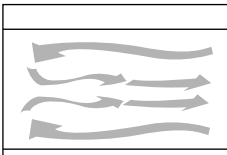

DEFROST (*only on some models*)
(ventilation only)

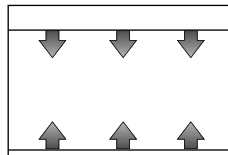

BAKE/TOAST
(only top heating element
and bottom heating element
on)

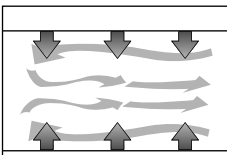

FAN & BAKE (*only on some models*)
(top heating element, bottom heating element and ventilation on)

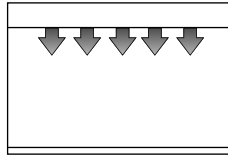

BROIL & ROTIS.
(only top heating element on
at maximum power)

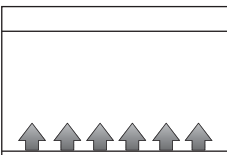

SLOW BAKE
(only bottom heating element
on)

Interior light (N) (*only on some models*) and Indicator light (C)

- When the oven is in function, the indicator light (C) and the interior light (N) (*only on some models*) stay on.

USING THE OVEN

General tips

- When cooking with the convection oven, traditional oven and grilling, always preheat the oven for 5 minutes to the set temperature.
- The cooking times depend on the quality of the products, on the temperature of the food and on personal tastes. The times indicated in the table are subject to variation, and do not include the time required to preheat the oven.
- To cook frozen foods refer to the recommended times on the product packaging.

Defrost (*only on some models*)

For proper defrosting in a short time, proceed as follows:

- Turn the function selector knob (D) to the "DEFROST" position.
- Turn the thermostat knob (A) to the "•" position.
- Turn the Timer knob (B) to the "ON" position.
- Place the bake pan (H) in guide 3, the wire rack (G) in the guide 2 and rest the food to be defrosted, then close the door.
- When defrosting is completed, turn the Timer knob (B) manually to the "OFF" position.

Example of defrosting: 1 kg/2.2 lbs. of meat, 80-90 minutes without turning it over.

Slow bake

Ideal for pastry and cakes. Good results are also achieved when completing the cooking of the bottom of the foods or for cooking that requires heat above all at the bottom.

- Place the bake pan (H) in guide 3, as shown in the figure on page 5.
- Turn the function selector knob (D) to the "SLOW BAKE" position.
- Select the required temperature using the thermostat knob (A).
- Turn the Timer knob (B) to the "ON" position; when cooking is completed turn the Timer knob (B) manually to the "OFF" position.

Keep warm

- Turn the thermostat knob (A) to the "KEEP WARM" position.
- Turn the function selector knob (D) to the "BAKE" position.
- Turn the Timer knob (B) to the "ON" position.
- Place the bake pan (H) in guide 3 and rest the food on the bake pan.
- To terminate the operation, turn the Timer knob (B) manually to the "OFF" position.

It is recommended not to leave the foods in the oven for too long, as these may dry out.

Fan & bake (*only on some models*)

This function is ideal for baking excellent pizzas, lasagna, "au gratin" dishes, all types of meat dishes (apart from small poultry), roast potatoes, cakes in general and bread.

Proceed as follows:

- Place the wire rack (G) or the bake pan (H) in the position shown in the table on page 5.
- Turn the function selector knob (D) to the "FAN & BAKE" position.
- Select the required temperature by turning the thermostat knob (A).
- Turn the Timer knob (B) to the "ON" position.
- After having pre-heated the oven for 5 minutes, place the food to be cooked inside.
- When cooking is completed, turn the Timer knob (B) manually to the "OFF" position.

Program	Thermostat knob	Times	wire rack/ bake pan position	Comments and tips
Quiche 700 g/1.5 lb.	400°F	30-35 min.	3	Use the bake pan.
Chicken 1 kg/2.2 lb	400°F	60-70 min.	3	Use the bake pan, turn after around 38 min.
Roast pork 900 g/2 lb	400°F	50-60 min.	3	Use the bake pan, turn after around 30 min.
Meatballs 650 g/1.4 lb	400°F	35-40 min.	3	Use the bake pan, turn after around 20 min.
Roast potatoes 500 g/1.1 lb	400°F	40-50 min.	2	Use the bake pan, mix twice.
Jam tarts 700 g/1.5 lb	350°F	35-40 min.	3	Use a cake dish.
Strudel 1 kg/2.2 lb	400°F	35-40 min.	2	Use the bake pan.
Margherita cakes 800 g/1.8 lb	350°F	25-30 min.	3	Use a cake dish.
Biscuits (shortbread) 100 g/0.2 lb	350°F	15-20 min.	2	Use the bake pan.
Bread 500 g/1.1 lb	400°F	20-25 min.	3	Use the bake pan greased with oil.

Bake

This function is ideal for all types of fish, stuffed vegetables, cakes with whipped egg-whites and cakes that require long cooking times (over 60 min.).

Proceed as follows:

- Place the wire rack or the bake pan in the position shown in the table.
- Turn the function selector knob (D) to the "BAKE" position.
- Select the required temperature by turning the thermostat knob (A).
- Turn the Timer knob (B) to the "ON" position.
- After having pre-heated the oven for 5 minutes, place the food inside.
- When cooking is completed, turn the Timer knob (B) manually to the "OFF" position.

Program	Thermostat knob	Times	wire rack/ bake pan position	Comments and tips
Macaroni "au gratin" 1 kg/2.2 lb	400°F	25-30 min.	2	Use an ovenproof dish.
Lasagna 1 kg/2.2 lb	400°F	25-30 min.	2	Use an ovenproof dish.
Pizza 500 g/1.1 lb	400°F	30-35 min.	3	Use the bake pan.
Trout 500 g/1.1 lb	350°F	30-35 min.	3	Use the bake pan, turn after 16 minutes.
Stuffed calamari 450 g/1 lb	350°F	35-30 min.	3	Use an ovenproof dish, turn halfway through cooking.
Tomatoes "au gratin" 550 g/1.2 lb	350°F	35-40 min.	2	Use the bake pan greased with oil and turn after 20 min.
Zucchini with tuna 750 g/1.6 lb	350°F	35-40 min.	2	Use the bake pan; add oil, the tomatoes and water; turn the bake pan after 20 min.
Plum cakes 1 kg/2.2 lb	350°F	65-75 min.	3	Use a mold and turn halfway through cooking.

Toast

- The dimensions of the wire rack (**G**) allow six slices of bread to be toasted at the same time. Best results are achieved, however, with four slices at a time.
- To toast the bread, place the slices as shown below:

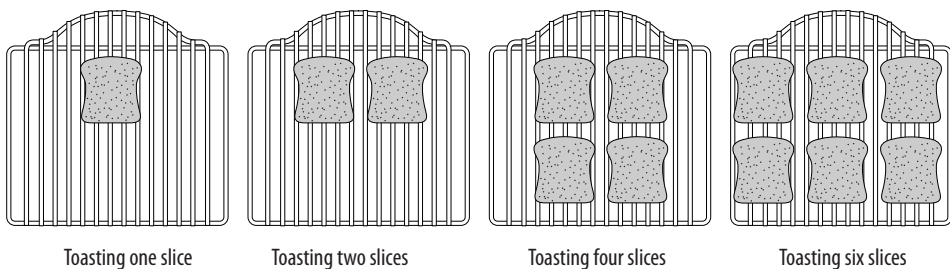

For consecutive uses, reduce the set toasting time.

Instructions for toasting bread

To automatically toast frozen bread, sandwiches, muffins and waffles, always use the wire rack.

1. Place the wire rack in the guide 2.
2. Place the food to be toasted in the center of the wire rack. Close the door.
3. Turn the thermostat knob (**A**) to the "TOAST/BROIL" position and the function selector (**D**) to the "BAKE" position.
4. The Timer knob (**B**) should be turned clockwise. When using the appliance for the first time, turn the Timer knob (**B**) to a medium value. Toast a few pieces of bread to check the set level. If necessary, adjust the knob as desired.
5. When toasting bread, both the top and bottom heating elements are on to toast both sides at the same time. A little condensation may form on the inside of the glass door. This is normal. It will disappear during toasting.
6. An audible signal indicates the end of the set time. The toasting is complete and the heating elements automatically switch off. Turn the thermostat knob (**A**) to the "-" position.

Note:

This appliance can automatically perform various degrees of toasting.

If, however, lighter toasting is preferred, simply stop the automatic cycle by turning the Timer knob (**B**) to the "OFF" position, to switch the oven off, without the risk of damaging it.

For darker toasting re-start the cycle by turning the Timer (**B**) clockwise until reaching the desired level.

Then manually turn the thermostat knob and the toast timer knob off, as described previously.

The best positions for each type of bread can be identified when using the oven regularly.

Tips for good toasting:

Larger pieces of bread and frozen bread take longer to toast. Just one slice of bread requires a lower setting than for multiple slices.

Broil

- Place the food to be grilled on the broil rack (P) inserted on the bake pan (H), and place them together in the guide 1.
- Close the door until you hear a "click" (see figure 1).
- Turn the function selector knob (D) to the BROIL or BROIL & ROTIS position.
- Turn the Timer knob (B) to the "ON" position.
- When cooking is completed, turn the Timer knob (B) manually to the "OFF" position.
- Turn halfway through cooking.

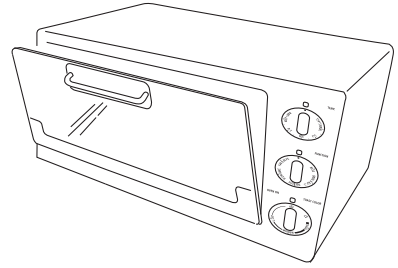

fig. 1

Program	Thermostat knob	Times	Comments and tips
Pork chops (2)	BROIL	30 min.	Turn after 16 minutes.
Hot dogs (3)	"	20 min.	Turn after 11 minutes.
Hamburgers (2)	"	25 min.	Turn after 13 minutes.
Sausages (4)	"	26 min.	Turn after 14 minutes.
Kebabs 500 g/1.1 lb	"	26 min.	Turn after 8, 15 and 21 minutes.

Grilling with the turnspit (only on some models)

This function is ideal for cooking chickens on the spit, fowl in general, roast pork and veal.

The rotisserie function can be used for a load up to 4.5 pounds.

- Place the food on the spit (I) and hold it firm using forks (fig. 2) (for best results, tie the meat using kitchen string).
- Insert the bake pan (H) in the guide 3 and the spit (I) in the turnspit mount (O) (fig. 3).
- Close the door until you hear a "click" (see figure 1).
- Turn the thermostat knob (A) to position TOAST/BROIL.
- Turn the function knob (D) to position BROIL & ROTIS.
- Turn the timer knob (B) to the "ON" position.

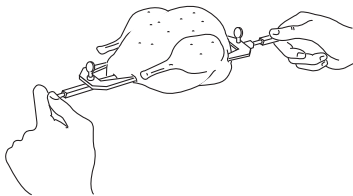

fig. 2

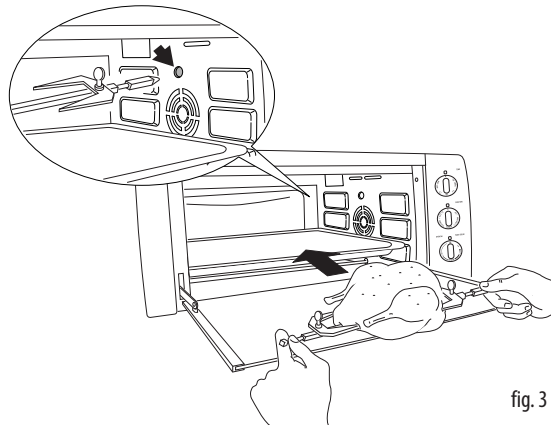

fig. 3

For information on the cooking times, refer to the instructions in the table below.

FOOD	WEIGHT	APPROX. TIME
Chicken	3-4 lbs.	120 min.
Rost pork	2-3 lbs.	90 min.

For larger foods, we recommend the FAN & BAKE mode.

CLEANING AND MAINTENANCE

Frequent cleaning prevents the formation of smoke and bad odors during cooking. Do not let fat accumulate inside the appliance.

Before any maintenance or cleaning operation, unplug the oven and wait for it to cool down.

Clean the door, the inside walls and the enamel or painted surfaces of the oven with a soap and water solution; dry thoroughly.

To clean the surfaces on the inside of the oven, never use products that corrode aluminum (detergents in spray cans) and never scrape the walls with sharp objects to avoid damage to the non-stick coat.

To clean the outside surface always use a damp sponge.

Avoid using abrasive products that may damage the exterior.

Make sure water or liquid soap does not seep into the vents on the top of the oven.

Never immerse the appliance in water; never wash it under a jet of water.

All the accessories are washed like normal dishes, either by hand or in the dishwasher.

Slide the crumb tray out from under the bottom of your oven. Wash by hand. Should the soilage be difficult to remove, rinse the crumb tray with hot soapy water and if necessary, scour it delicately, without scratching it.

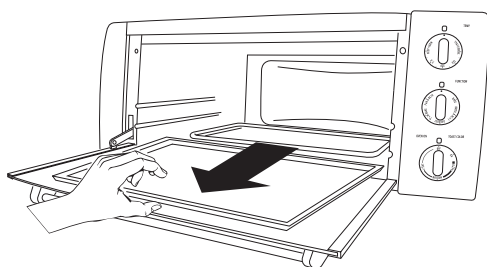
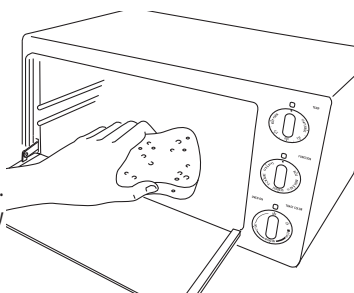
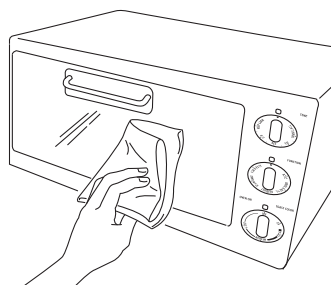

LIMITED WARRANTY

This warranty applies to all products with De'Longhi or Kenwood brand names.

What does the warranty cover?

We warrant each appliance to be free from defects in material and workmanship. Our obligation under this warranty is limited to repair at our factory or authorized service center of any defective parts or part thereof, other than parts damaged in transit. In the event of a products replacement or return, the unit must be returned transportation prepaid. The repaired or new model will be returned at the company expense.

This warranty shall apply only if the appliance is used in accordance with the factory directions, which accompany it, and on an Alternating current (AC) circuit.

How long does the coverage last?

This warranty runs for one year (1) from the purchase date found on your receipt and applies only to the original purchaser for use.

What is not covered by the warranty?

The warranty does not cover defects or damage of the appliance, which result from repairs or alterations to the appliance outside our factory or authorized service centers, nor shall it apply to any appliance, which has been subject to abuse, misuse, negligence or accidents. Also, consequential and incidental damage resulting from the use of this product or arising out of any breach of contract or breach of this warranty are not recoverable under this warranty. Some states do not allow the exclusion or limitation of incidental or consequential damage, so the above limitation may not apply to you.

How do you get service?

If repairs become necessary, see contact information below:

U.S. Residents:

Please contact our toll free hotline at 01-800-322-3848 or log onto our website at www.delonghi.com.

Residents of Canada: Please contact our toll free hotline at 01-888-335-6644 or log onto our website at www.delonghi.com.

Residents of Mexico: Please contact our toll free hotline at 01-800-711-8805 or log onto our website at www.delonghi.com.

The above warranty is in lieu of all other express warranties and representations. All implied warranties are limited to the applicable warranty period set forth above. This limitation does not apply if you enter into an extended warranty with De'Longhi. Some states/countries do not allow limitations on how long an implied warranty lasts, so the above exclusions may not apply to you. De'Longhi does not authorize any other person or company to assume for it any liability in connection with the sale or use of its appliance.

How does state law apply?

This warranty gives you specific legal rights, and you may also have other rights, which vary from state to state/country to country.

Free Manuals Download Website

<http://myh66.com>

<http://usermanuals.us>

<http://www.somanuals.com>

<http://www.4manuals.cc>

<http://www.manual-lib.com>

<http://www.404manual.com>

<http://www.luxmanual.com>

<http://aubethermostatmanual.com>

Golf course search by state

<http://golfingnear.com>

Email search by domain

<http://emailbydomain.com>

Auto manuals search

<http://auto.somanuals.com>

TV manuals search

<http://tv.somanuals.com>