



LED Tube Light Specification

OADT-10UAD

Delta Electronics Inc.

**252 Shang Ying Road, Guishang Industrial Zone,
Taoyuan County, 33341, Taiwan, R.O.C**

www.deltaww.com.tw

CONTENT

- 1. OUTLOOK**
- 2. APPLICATION**
- 3. FEATURES**
- 4. OPERATION CONDITION**
- 5. SPECIFICATION**
- 6. PHOTOMETRY**
- 7. PRODUCT CODE DEFINITION**
- 8. MATERIAL FINISH**
- 9. ASSEMBLY AND INSTALLATION**
- 10. WARNING**
- 11. WARRANTEE**
- 12. ENVIRONMENTAL AND ECONOMIC BENIFIT**

 **OUTLOOK**



3D Birdview

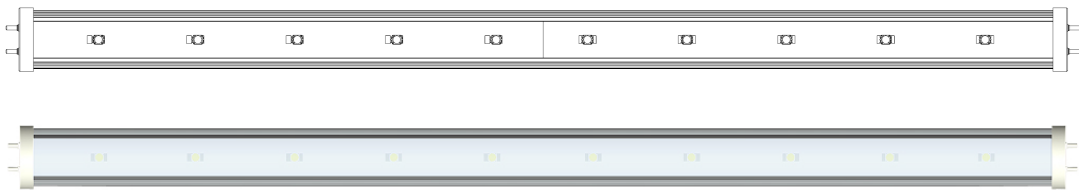

Top View

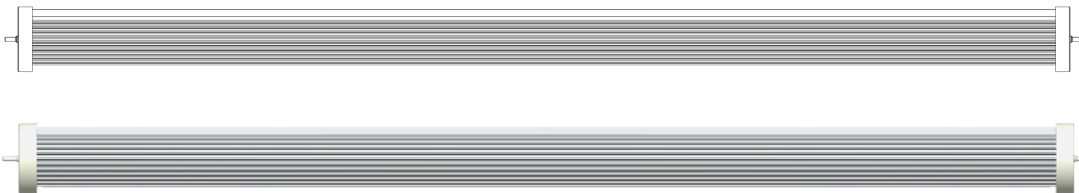



Side View



Bottom View







APPLICATIONS

-  House Lighting
-  Office Lighting
-  Store Lighting





FEATURES

-  Easy to install on T8 fluorescence tube socket.
-  System design with integration of power and LED tube light
-  Good thermal dissipation design.
-  Over 70% lumen maintenance at 50,000 hours (LED life 50,000 hours) at max acceptable ambient temperature



OPERATION CONDITION

-  Operation ambient temperature -40°C to +50°C
-  Input voltage 100V~240V AC, 50/60Hz



SPECIFICATION

-  Optical

Brightness	900 Lm
CCT	Cool Daylight
Average illumination	18lux @8m
CRI	70

-  Mechanical and Dimension

Dimension	Φ=32.5mm L=580mm
Weight	300g

-  Electrical

Input Voltage	100V~240V AC, 50/60Hz
Power Consumption	10Watt
Power Factor	> 0.9
Luminaire Efficacy	Warm white:56 lm/Watt Neutral white: 69 lm/Watt



PHOTOMETRY

✚ Cut-off Light Pattern(?)

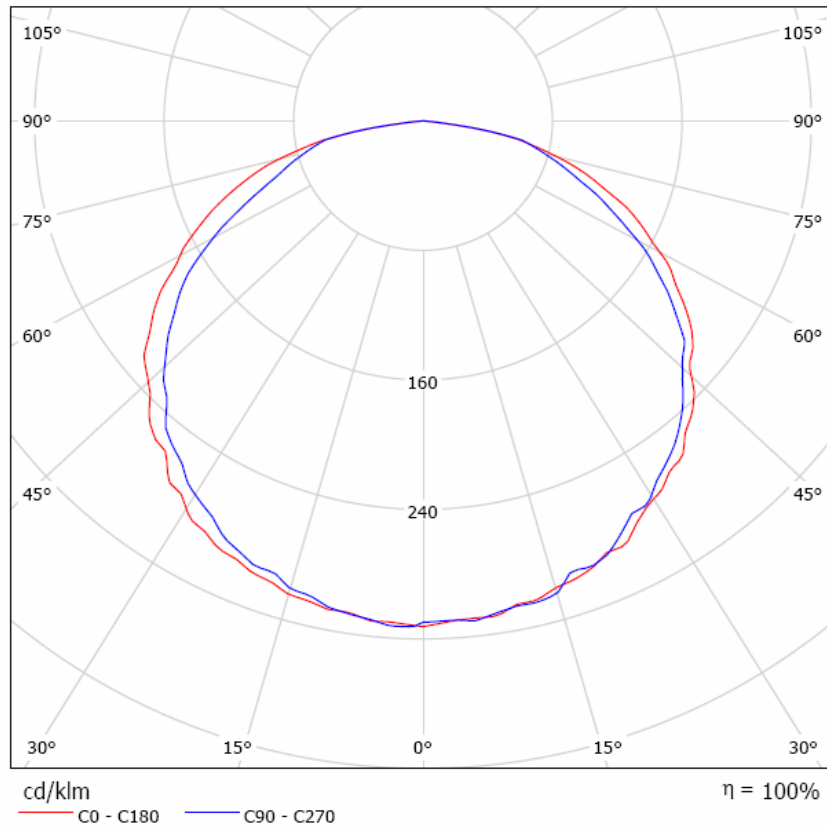

✚ Illuminance

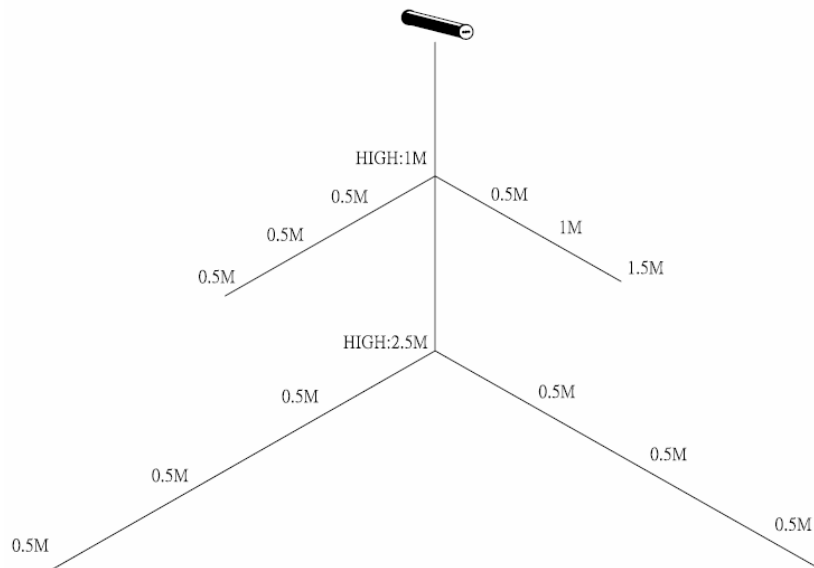



PRODUCT CODE DEFINITION

O	A	D	T	-	1	0	U	A	D	D	B	X	X
1				2		3	4	5	6	7	8	9	

1.SERIES CODE

OADT : OA Lighting

2.Input Power

10 : 10W

20 : 20W

3.Input voltage

U : 100-240V AC

E : 200-240V AC

A : 100-120V AC

4. Lamp dimension

A : 60

B : 120

C : 30x60

D : 60x60

E : 30x120

F : 60x120

5.Cover type

T : Transparent

D : Diffuse

M : Microlens

6.COLOR

W : Warm white

N : Neutral white

D : Daylight

7.Features

P : Premium (PFC+TRAIC Dimming)

C : Commercial (only PFC)

S : Step dimming

D : TRAIC Dimming



B : Basic (not dimmable, no PFC)

8.LED supplier

9. Binning



MATERIALS AND FINISH

-  Ten high brightness LEDs per tube light
-  Anodized cast aluminum heatsink
-  300mA constant current driver



ASSEMBLY AND INSTALLATION

- Assembly
- Installation

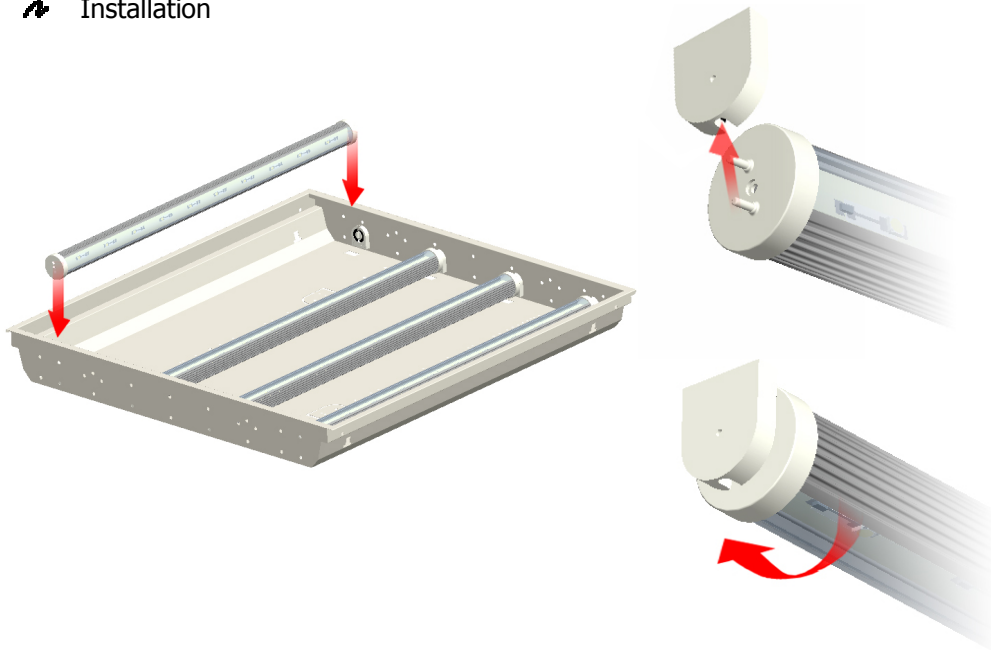

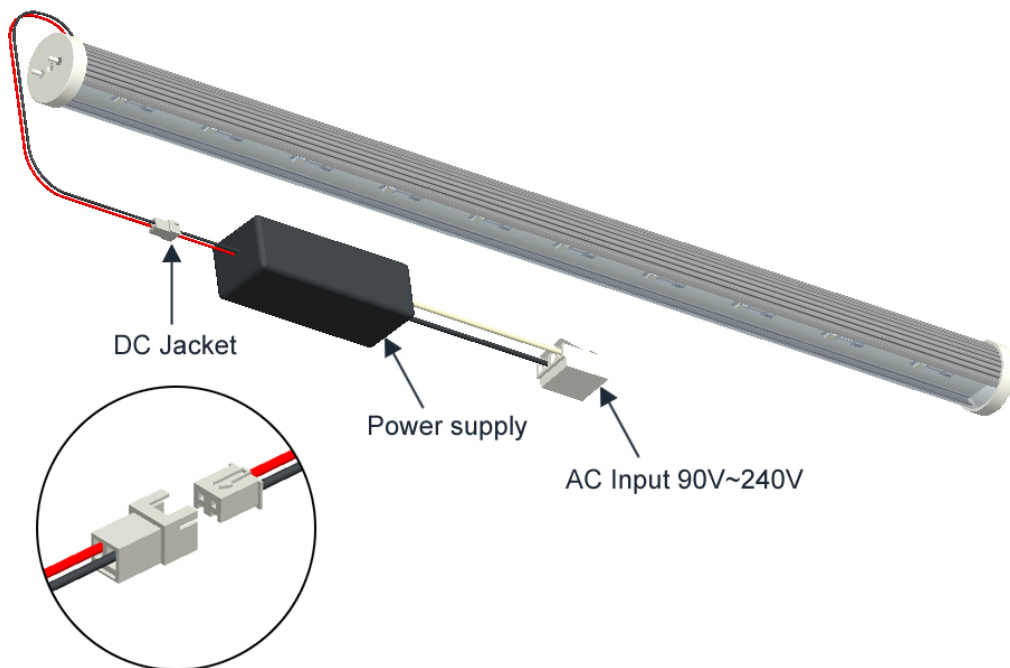

- Installation







WARNING

-  Not suitable for high temperature and moisture area.
-  Not suitable for close system fixture.
-  Do not use inappropriate power supply.



WARRANTY

-  3 years of the entire system (power, LED tube light) with no mechanical damage under normal operation condition
-  LED lumen degradation within 20% in 3 years (reference TW environment only)



ENVIRONMENTAL AND ECONOMIC BENEFIT

Energy Comparison		600mm T8 tube	OADT-10AUDDB
Power Consumption (W)		18	10
Energy Saving			
Power (kW)		0.018	0.01
%		100%	56%
Power Consumption Per Year	kWh, 12hr/day light on	79	44
Power Saving Per Year (kWh)			35
Money Saving Per Year (USD)	\$0.15/kWh		5
3-Year Saving (USD)			16
3-Year Maintain Fee	T8 tube \$0.75(×3years)	2.25	0
3-Year Total Money Saving (USD)			18
3-Year Total CO2 Emission Saving (Kg)	0.736Kg CO2/kWh		77

End of Specification

Free Manuals Download Website

<http://myh66.com>

<http://usermanuals.us>

<http://www.somanuals.com>

<http://www.4manuals.cc>

<http://www.manual-lib.com>

<http://www.404manual.com>

<http://www.luxmanual.com>

<http://aubethermostatmanual.com>

Golf course search by state

<http://golfingnear.com>

Email search by domain

<http://emailbydomain.com>

Auto manuals search

<http://auto.somanuals.com>

TV manuals search

<http://tv.somanuals.com>