

ASSEMBLY
OPERATION
REPLACEMENT PARTS

Demco

2003 Hyundai Accent

Doing Our Best to Provide You the Best

BOLT TORQUE SPECIFICATIONS

STANDARD BOLTS:			METRIC BOLTS:	
Size	Grade	Torque	Size	Torque
5/16"	5	20 ft/lbs.	8mm	22 ft/lbs.
3/8"	5	35 ft/lbs.	10mm	42 ft/lbs.
7/16"	5	56 ft/lbs.	12mm	70 ft/lbs.
1/2"	5	85 ft/lbs.	14mm	95 ft/lbs.

READ complete manual CAREFULLY
BEFORE attempting operation.

Pin height - 13-1/2" Centers - 23-3/8"

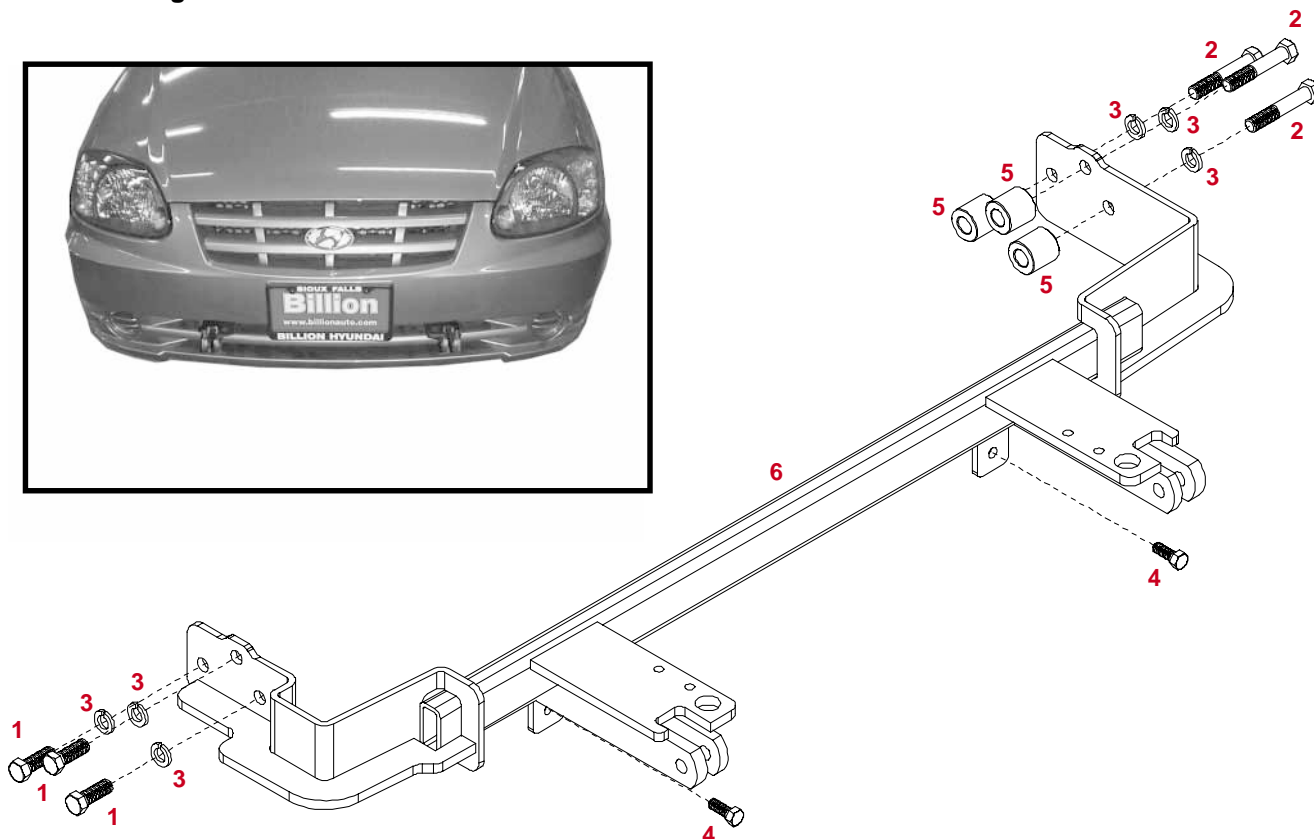

9517157 PARTS LIST

REF. NO.	PART NO.	QTY.	DESCRIPTION
1.	10931	3	12mm-1.25 x 35mm Hex Bolt
2.	10951	3	12mm-1.25 x 70mm Hex Bolt
3.	07288	6	12mm Lock Washer
4.	07594	2	3/8" x 1" Self-tapping Hex Bolt
5.	09274-95	3	Spacer Bushing
6.	11469-35	1	Base Plate Crossmember

Please order replacement parts by PART NO. and DESCRIPTION.

DEMCO • Dethmers Mfg. Co. • 4010 320th Street • P.O. Box 189 • Boyden, IA 51234
 PH: (712) 725-2311 or (712) 725-2302 • Toll Free: 1-800-543-3626 • FAX: (712) 725-2380
www.demco-products.com

WARNING: FAILURE TO FOLLOW THESE INSTRUCTIONS CAN RESULT IN LOSS OF TOWING VEHICLE CONTROL, SEPARATION OF THE TOW BAR FROM THE TOWING VEHICLE, SEPARATION OF THE TOWED VEHICLE FROM THE TOW BAR, CAUSING SEVERE PERSONAL INJURY, DEATH, OR PROPERTY DAMAGE.

CAUTION

Safety is of utmost importance at all times. There are several items that must be checked each time before using and while using a tow bar. Before allowing anyone to hook up or operate a tow bar, be sure they have read and understand the proper operating procedure.

DO NOT use worn or damaged cables and/or pins.

Be sure the **SAFETY CABLES** are hooked, chassis to chassis, to both the towing and towed vehicles using the crisscross method.

Check clearance between vehicles in a turning situation.

Check base plate mounting bolts for tightness and frame for metal fatigue.

Do not load the towed vehicle with anything as you may exceed the towing capacity of the tow bar.

Keep fingers away from pivot points to prevent personal injury.

Be sure the steering components of the towed vehicle are properly aligned.

NOTE: This unit can be backed up in moderate increments. Any severe backwards cornering could result in damage to the Tow Bar and/or towed vehicle chassis.

For automatic transmissions: Consult your vehicle owners manual for towing suitability with the drive shaft connected. Otherwise, the towed vehicle will have to be equipped with a transmission pump or drive shaft disconnect.

Check to make sure that all lights are in proper working order.

The information on towability of vehicles is reprinted with permission of MotorHome® Magazine, and is believed to be reliable. However, Demco does not warrant the information to be correct. Always consult your towed vehicle owner's manual and follow towing instructions. Each year, MotorHome® Magazine, compiles a list of vehicles that can be towed four-down behind a motorhome with no modifications required. This guide contains only those vehicles that have been approved by their manufacturers for towing. This list is enclosed with this manual.

 **Caution: MotorHome® Magazine** left out any vehicles that have towing speed limits slower than 55 m.p.h., or distance limits of less than 200 miles. At a minimum, these vehicles require significant modification, such as the use of an aftermarket product, to make them towable. The availability of a **Demco Tow Bar Base Plate** does not imply that these vehicles can be modified or that there is an aftermarket product available. Refer to your vehicle owner's manual or consult your dealer to determine whether your vehicle can be modified to make it towable. Failure to observe this precaution could result in property damage or personal injury.



1. Remove two bolts that hold headlights and unplug headlights and set aside.

IMPORTANT INSTALLATION ITEMS

DEMCO products and accessories are intended to be installed by professional installers with experience, proper equipment and the ability to do modification work. Installers with these qualifications can be found in RV and Automotive Service Centers.

If the car to be towed has been in an accident, the chassis may be damaged in an area where the Base Plate attaches. It may no longer be suitable for towing. Extreme caution and careful examination are required in such a situation. It is also likely, even from a minor accident, that the hole alignment will be more difficult due to hole alignment problems.

Many DEMCO Base Plates are designed to use existing holes and hardware to mount the Base Plate to the towed vehicle. Even though the bolt is there, however, do not assume it is adequate for mounting the Base Plate. Manufacturers make many changes in hardware both within and between model years. Be sure the bolt is long enough to protrude past the nut a distance no less than 1/2 the diameter of the bolt, after the Base Plate is mounted. The threads should be in good condition. **We require that "LOCTITE® Blue" be used on all bolts.** If a new bolt is required, be sure it is SAE Grade 5 or Metric 8.8.

NOTE: The dimensional variations between otherwise identical vehicles can be considerable. Some minor modifications may have to be made to ensure a proper fit.

INSTALLATION INSTRUCTIONS

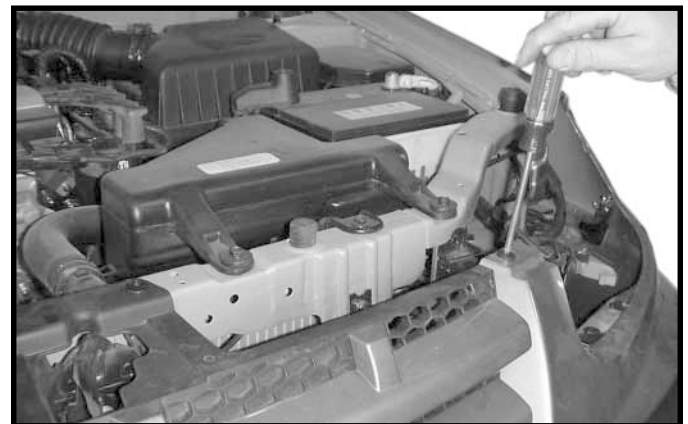

2. Open hood and remove four plastic push fasteners from top of fascia.

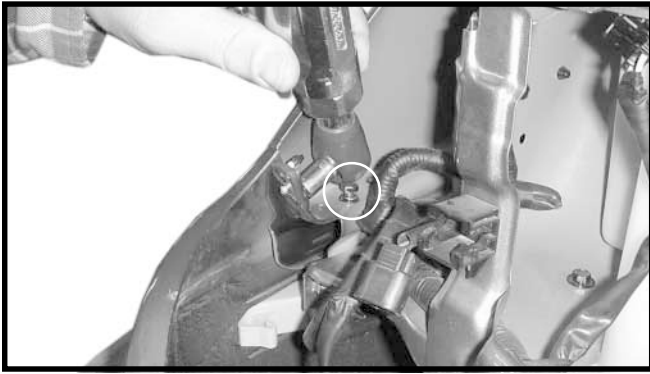

3. Remove one nut and one bolt from fascia to fender on each side.

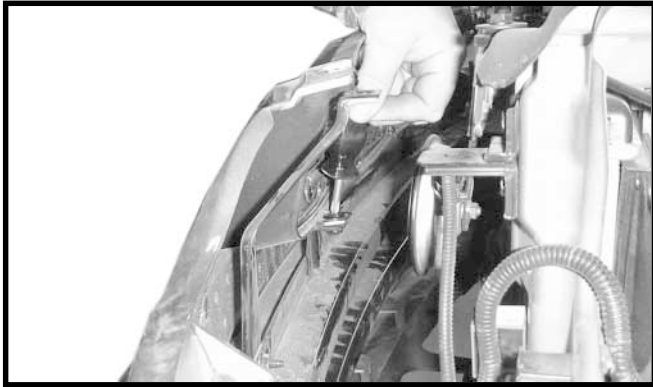

4. Remove two plastic push fasteners from back of fascia grill area.



5. Remove two plastic push fasteners from underneath headlight (top of fascia) on each side.

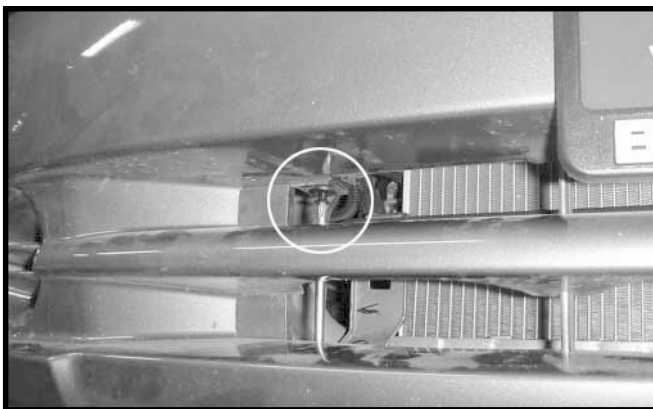

6. Remove two plastic push fasteners across bottom of bumper (middle of fascia).

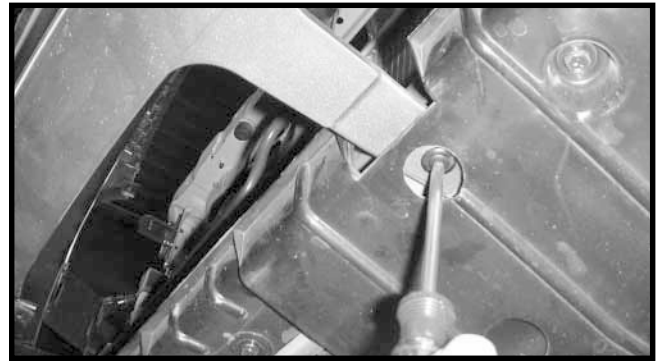

7. Remove two plastic push fasteners from bottom of fascia.



8. Remove two plastic push fasteners from each side underneath fascia to inner wheel well extension.



9. Pull inner wheel well extension away from fender to gain access to remove one screw, fascia to fender, on each side.

10. Carefully pull fascia straight back and up in the middle and off.

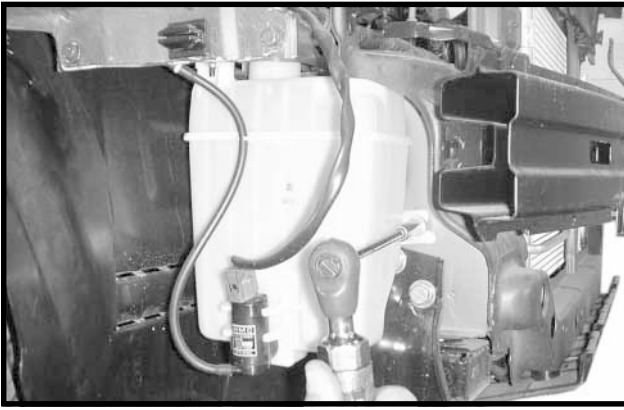

11. Remove three bolts from windshield washer tank, unplug wiring and hose, and set tank aside or tie off.

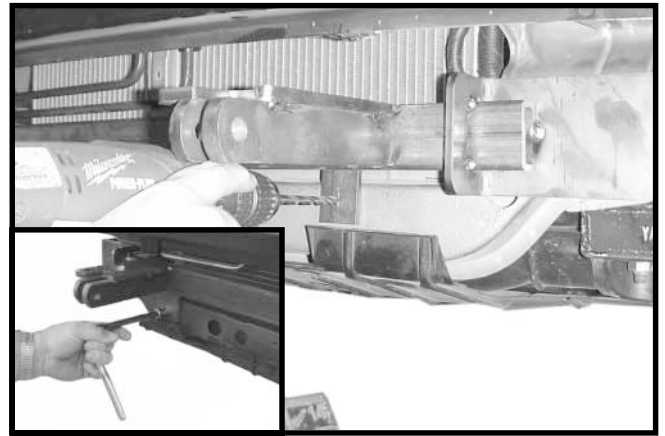

14. Drill two 5/16" holes, one through each center base plate tabs. With blue **LOCTITE** on each 3/8" self-tapping bolts, install through drilled holes.

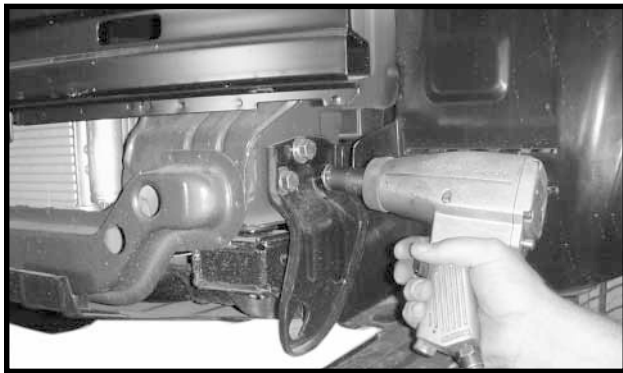

15. Reinstall windshield washer tank.

12. Remove tie down brackets from each side, three bolts from each side, these will not be reused.

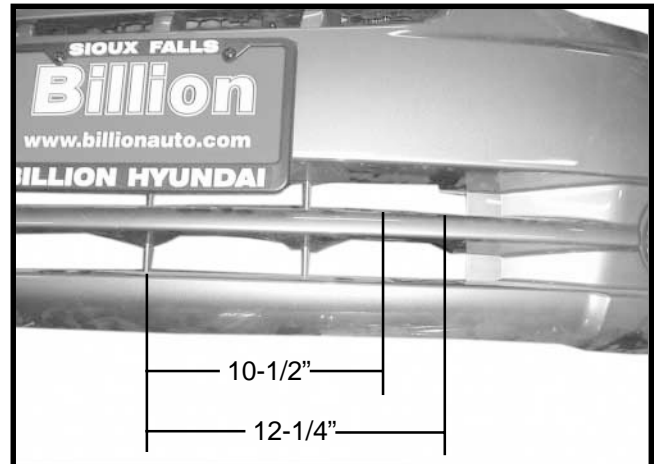

16. Cut outside grill bar on fascia by measuring from the center bar as shown in picture. **NOTE:** Some trimming maybe needed for base plate to pass through.

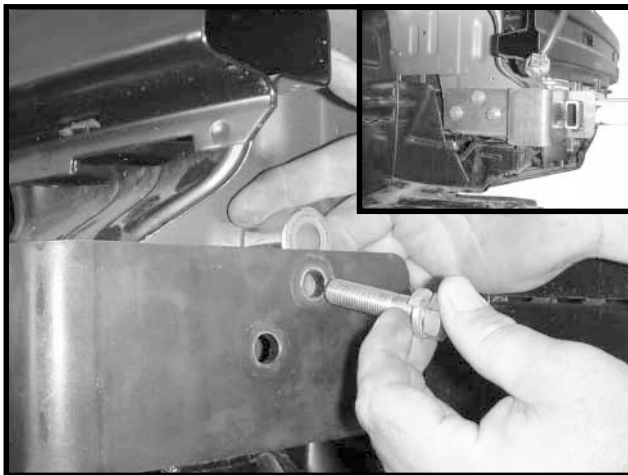

13. Slide base plate on passenger's side first, then pivot over driver's side. Use three 12mm-1.25 x 35mm bolts and 12 mm lock washers on passenger's side using blue **LOCTITE** on all bolts. On driver's side, use three 12mm-1.25 x 70mm bolts, 12mm lock washers, and put three spacer bushings behind baseplate up against frame. Push base plate back against vehicle so center tabs of base plate are tight against vehicle. Tighten the six 12mm bolts.



17. Reinstall fascia, all hardware and headlights.

Free Manuals Download Website

<http://myh66.com>

<http://usermanuals.us>

<http://www.somanuals.com>

<http://www.4manuals.cc>

<http://www.manual-lib.com>

<http://www.404manual.com>

<http://www.luxmanual.com>

<http://aubethermostatmanual.com>

Golf course search by state

<http://golfingnear.com>

Email search by domain

<http://emailbydomain.com>

Auto manuals search

<http://auto.somanuals.com>

TV manuals search

<http://tv.somanuals.com>