

DENON

DVD AUDIO-VIDEO / SUPER AUDIO CD PLAYER

DVD-758

OPERATING INSTRUCTIONS

MODE D'EMPLOI

INSTRUCCIONES DE FUNCIONAMIENTO

WARNING: TO REDUCE THE RISK OF FIRE OR ELECTRIC SHOCK, DO NOT EXPOSE THIS APPLIANCE TO RAIN OR MOISTURE.



CAUTION
RISK OF ELECTRIC SHOCK
DO NOT OPEN



CAUTION:

TO REDUCE THE RISK OF ELECTRIC SHOCK, DO NOT REMOVE COVER (OR BACK). NO USER SERVICEABLE PARTS INSIDE. REFER SERVICING TO QUALIFIED SERVICE PERSONNEL.



The lightning flash with arrowhead symbol, within an equilateral triangle, is intended to alert the user to the presence of uninsulated "dangerous voltage" within the product's enclosure that may be of sufficient magnitude to constitute a risk of electric shock to persons.



The exclamation point within an equilateral triangle is intended to alert the user to the presence of important operating and maintenance (servicing) instructions in the literature accompanying the appliance.

The caution marking is located on the rear of the cabinet.

IMPORTANT SAFEGUARDS

- 1) Read Instructions - All the safety and operating instructions should be read before the product is operated.
- 2) Retain Instructions - The safety and operating instructions should be retained for future reference.
- 3) Heed Warnings - All warnings on the product and in the operating instructions should be adhered to.
- 4) Follow Instructions - All operating and use instructions should be followed.
- 5) Cleaning - Unplug this product from the wall outlet before cleaning. Do not use liquid cleaners or aerosol cleaners. Use a damp cloth for cleaning.
- 6) Attachments - Do not use attachments not recommended by the product manufacturer as they may cause hazards.
- 7) Water and Moisture - Do not use this product near water - for example, near a bath tub, wash bowl, kitchen sink, or laundry tub; in a wet basement; or near a swimming pool; and the like.
- 8) Accessories - Do not place this product on an unstable cart, stand, tripod, bracket, or table. The product may fall, causing serious injury to a child or adult, and serious damage to the product. Use only with a cart, stand, tripod, bracket, or table recommended by the manufacturer, or sold with the product. Any mounting of the product should follow the manufacturer's instructions, and should use a mounting accessory recommended by the manufacturer.
- 9) A product and cart combination should be moved with care. Quick stops, excessive force, and uneven surfaces may cause the product and cart combination to overturn.
- 10) Ventilation - Slots and openings in the cabinet are provided for ventilation and to ensure reliable operation of the product and to protect it from overheating, and these openings must not be blocked or covered. The openings should never be blocked by placing the product on a bed, sofa, rug, or other similar surface. This product should not be placed in a built-in installation such as a bookcase or rack unless proper ventilation is provided or the manufacturer's instructions have been adhered to.
- 11) Power Sources - This product should be operated only from the type of power source indicated on the marking label. If you are not sure of the type of power supply to your home, consult your product dealer or local power company. For products intended to operate from battery power, or other sources, refer to the operating instructions.
- 12) Grounding or Polarization - This product may be equipped with a polarized alternating-current line plug (a plug having one blade wider than the other). This plug will fit into the power outlet only one way. This is a safety feature. If you are unable to insert the plug fully into the outlet, try reversing the plug. If the plug should still fail to fit, contact your electrician to replace your obsolete outlet. Do not defeat the safety purpose of the polarized plug.
- 13) Power-Cord Protection - Power-supply cords should be routed so that they are not likely to be walked on or pinched by items placed upon or against them, paying particular attention to cords at plugs, convenience receptacles, and the point where they exit from the product.
- 14) Lightning - For added protection for this product during a lightning storm, or when it is left unattended and unused for long periods of time, unplug it from the wall outlet. This will prevent damage to the product due to lightning and power-line surges.
- 15) Power lines - An outside antenna system should not be located in the vicinity of overhead power lines or other electric light or power circuits, or where it can fall into such power lines or circuits. When installing an outside antenna system, extreme care should be taken to keep from touching such power lines or circuits as contact with them might be fatal.
- 16) Overloading - Do not overload wall outlets, extension cords, or integral convenience receptacles as this can result in a risk of fire or electric shock.
- 17) Object and Liquid Entry - Never push objects of any kind into this product through openings as they may touch dangerous voltage points or short-out parts that could result in a fire or electric shock. Never spill liquid of any kind on the product.
- 18) Servicing - Do not attempt to service this product yourself as opening or removing covers may expose you to dangerous voltage or other hazards. Refer all servicing to qualified service personnel.
- 19) Damage Requiring Service - Unplug this product from the wall outlet and refer servicing to qualified service personnel under the following conditions:
 - a) When the power-supply cord or plug is damaged.
 - b) If liquid has been spilled, or objects have fallen into the product.
 - c) If the product has been exposed to rain or water.
 - d) If the product does not operate normally by following the operating instructions. Adjust only those controls that are covered by the operating instructions as an improper adjustment of other controls may result in damage and will often require extensive work by a qualified technician to restore the product to its normal operation.
 - e) If the product has been dropped or damaged in any way.
 - f) When the product exhibits a distinct change in performance - this indicates a need for service.
- 20) Replacement Parts - When replacement parts are required, be sure the service technician has used replacement parts specified by the manufacturer or have the same characteristics as the original part. Unauthorized substitutions may result in fire, electric shock, or other hazards.
- 21) Safety Check - Upon completion of any service or repairs to this product, ask the service technician to perform safety checks to determine that the product is in proper operating condition.
- 22) Heat - The product should be situated away from heat sources such as radiators, heat registers, stoves, or other products (including amplifiers) that produce heat.

PORTABLE CART WARNING
(Symbol provided by RETAC)



S3125A

PRECAUTIONS

Laser Safety

This unit employs a laser. Only a qualified service person should remove the cover or attempt to service this device, due to possible eye injury.

- CAUTION:** USE OF CONTROLS OR ADJUSTMENTS OR PERFORMANCE OF PROCEDURES OTHER THAN THOSE SPECIFIED HEREIN MAY RESULT IN HAZARDOUS RADIATION EXPOSURE.
- CAUTION:** VISIBLE AND INVISIBLE LASER RADIATION WHEN OPEN AND INTERLOCK DEFEATED. DO NOT STARE INTO BEAM.
- LOCATION:** INSIDE, NEAR THE DECK MECHANISM.

FCC WARNING- This equipment may generate or use radio frequency energy. Changes or modifications to this equipment may cause harmful interference unless the modifications are expressly approved in the manual. The user could lose the authority to operate this equipment if an unauthorized change or modification is made.

RADIO-TV INTERFERENCE

This equipment has been tested and found to comply with the limits for a Class B digital device, pursuant to Part 15 of the FCC Rules. These limits are designed to provide reasonable protection against harmful interference in a residential installation. This equipment generates, uses, and can radiate radio frequency energy and, if not installed and used in accordance with the instructions, may cause harmful interference to radio communications. However, there is no guarantee that interference will not occur in a particular installation. If this equipment does cause harmful interference to radio or television reception, which can be determined by turning the equipment off and on, the user is encouraged to try to correct the interference by one or more of the following measures:

- 1) Reorient or relocate the receiving antenna.
- 2) Increase the separation between the equipment and receiver.
- 3) Connect the equipment into an outlet on a circuit different from that to which the receiver is connected.
- 4) Consult the dealer or an experienced radio/TV technician for help.

This Class B digital apparatus complies with Canadian ICES-003.

CAUTION: TO PREVENT ELECTRIC SHOCK, MATCH WIDE BLADE OF PLUG TO WIDE SLOT, FULLY INSERT.

Non-use periods - Turn off the unit when it is not in use. Unplug the unit from the household AC outlet if it is not to be used for a long time. Unplug the unit during lightning storms.

Please read this operating instructions carefully before using your DVD player, and keep it for future reference.

Important

Use only discs marked with logos listed on page 6.

Power Supply

The main power supply is engaged when the main plug is plugged in a 120V, 60Hz AC outlet. To operate the unit, press the **ON/STANDBY** button to turn on the unit.

Warning

To avoid fire or electric shock, do not expose this unit to rain or moisture.

WARNING:
LIVE PARTS INSIDE.
DO NOT REMOVE ANY SCREWS.

Installation Location

For safety and optimum performance of this unit:

- Do not stand the unit up vertically. Install the unit in a horizontal and stable position. Do not place anything directly on top of the unit. Do not place the unit directly on top of the TV.
- Shield it from direct sunlight and keep it away from sources of intense heat. Avoid dusty or humid places. Avoid places with insufficient ventilation for proper heat dissipation. Do not block the ventilation holes on the sides of the unit. Avoid locations subject to strong vibration or strong magnetic fields.
- Be sure to remove a disc and unplug the AC power cord from the outlet before carrying the unit.

Cautions on Installation

Noise or disturbance of the picture may be generated if this unit or any other electronic equipment using microprocessors is used near a tuner or TV.

If this happens, take the following steps:

- Install this unit as far as possible from the tuner or TV.
- Set the antenna wires from the tuner or TV away from this unit's power cord and input/output connection cords.
- Noise or disturbance tends to occur particularly when using indoor antennas or 300Ω/ohms feeder wires. We recommend using outdoor antennas and 75Ω/ohms coaxial cables.

NOTE:

- For heat dispersal, do not install this equipment in a confined space such as a book case or similar unit.

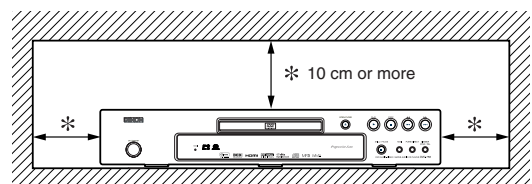

PRECAUTIONS

Dew Warning

Moisture condensation may occur inside the unit when it is moved from a cold place to a warm place, or after heating a cold room or under conditions of high humidity. Do not use the DVD Player at least for 2 hours until its inside is dry.

Avoid the Hazards of Electrical Shock and Fire

- Do not handle the power cord with wet hands.
- Do not pull on the power cord when disconnecting it from AC wall outlet. Grasp it by the plug.
- If, by accident, water is spilled on this unit, unplug the power cord immediately and take the unit to our Authorized Service Center for servicing.

Caution

- 1) Do not attempt to open the cabinet. There are no parts you can service inside. Refer all servicing to qualified service personnel.
- 2) Slot and openings in the cabinet and at the side or bottom are provided for ventilation. To ensure reliable operation and to protect the unit from overheating these opening must not be blocked or covered. Avoid enclosed spaces such as book cases unless proper ventilation is provided.
- 3) Keep the unit away from the radiator heat sources.
- 4) Avoid using near strong magnetic fields.
- 5) Do not push objects of any kind into this through the

- 6) Never spill liquid of any kind on this unit.
If liquid is spilled into the unit, consult qualified service engineer.
- 7) Use this unit in a horizontal (flat) position only.
- 8) This equipment is in Stand-by mode when it turns off whilst the power cord is connected.
- 9) Keep the set free from moisture, water and dust.
- 10) Sufficiently ventilate the place of installation. If the unit is left in a room full of the smoke from cigarettes, etc., for long periods of time, the surface of the optical pickup could get dirty, in which case it will not be able to read the signals properly.
- 11) Store the operating instructions in a safe place. After reading the operating instructions, store them in a safe place as they could come in handy in the future.
- 12) Handle the power cord carefully. Hold the plug when unplugging the cord.
- 13) All the safety cautions and operating instructions should be read before the DVD player is operated.
- 14) Use caution not to pinch your finger in the disc slot.
- 15) Do not put heavy objects on the AC power cord.
- 16) Keep the AC power cord away from heat appliances.
- 17) Be sure to remove a disc and unplug the AC power cord from the outlet before carrying the DVD player.
- 18) Do not put any pressure to the DVD player when carrying.
- 19) Do not use the DVD player outdoors.

TABLE OF CONTENTS

■ IMPORTANT SAFEGUARDS	2	Resume	18
■ PRECAUTIONS	3	Fast Forward / Reverse Search	18
Laser Safety	3	Slow Forward / Slow Reverse	19
Important	3	Step by Step Playback	19
Power Supply	3	Zoom	19
Warning	3	Title / Chapter Search	19
Installation Location	3	BY USING THE SEARCH MODE BUTTON	19
Cautions on Installation	3	BY USING THE SKIP BUTTONS ◀◀ ▶▶	19
Dew Warning	4	Track Search	19
Avoid the Hazards of Electrical Shock and Fire	4	BY USING THE SEARCH MODE BUTTON	19
Caution	4	BY USING THE SKIP BUTTONS ◀◀ ▶▶	19
■ INTRODUCTION	5	Time Search	20
About Copyright	5	Marker Setup Screen	20
Notice for the Progressive Scan Outputs	5	Repeat	20
Supplied Accessories	5	REPEAT TITLE / CHAPTER	20
Symbols Used in this Manual	5	REPEAT TRACK / GROUP / ALL	20
■ ABOUT THE DISCS	6	A-B REPEAT	20
Playable Discs	6	Program Playback	21
■ FEATURES	7	Random Playback	21
■ FUNCTIONAL OVERVIEW	8	MP3 / JPEG / WMA Playback	22
FRONT PANEL	8	DivX® Playback	23
REMOTE CONTROL	8	DivX® Subtitle	24
Tour of the Remote Control	9	Changing the On-Screen Display	24
Front Panel Display	10	Slide Show Mode	25
Displays during Operation	11	Dialog Speed	25
Loading the Batteries	11	Audio Language	26
Using a Remote Control	11	Subtitle Language	26
■ CONNECTIONS	12	Camera Angle	26
Description - Rear Panel	12	Picture Control	27
Connection to an Audio System	13	Sound Mode	27
Connection to 5.1-channel Surround Sound System	14	Stereo Sound Mode	27
Connection to a TV (for video)	15	Super Audio CD Setup	27
Connection to a TV with an HDMI Compatible Port	16	Virtual Surround	27
Connecting the AC Cord	16	Black Level Setting	27
■ DISC PLAYBACK	17	■ DVD SETUP	28
Basic Playback	17	Language Setting	28
HDMI Setup	17	Display Setting	28
Pure Direct Mode	17	Audio Setting	29
Brightness of the Front Panel Display	17	Speaker Setting for ANALOG AUDIO	30
TV TYPE	17	Speaker Setting for HDMI AUDIO	31
General Features	17	Ratings Control	31
Disc Menu	18	RATING LEVEL	31
Title Menu	18	IF YOU FORGET THE PASSWORD	31
CALLING UP A MENU SCREEN DURING PLAYBACK	18	CONTROL LEVELS	31
DVD Audio Playback	18	Others Setting	31
PLAYBACK OF ALL GROUPS	18	Reset to the Default Settings (except for Ratings Control)	32
PLAYBACK FROM A DESIRED GROUP	18	Language Code List	32
PAGE SELECTION	18	■ TROUBLESHOOTING GUIDE	33
PLAYBACK OF THE BONUS GROUP	18	■ SPECIFICATIONS	34
Still / Pause	18	■ MAINTENANCE	34

INTRODUCTION

The serial number of this product may be found on the back of the DVD player. No others have the same serial number as yours. You should record the number and other vital information here and retain this book as a permanent record of your purchase to aid identification in case of theft. Serial numbers are not kept on file.

Date of Purchase	
Dealer Purchase from	
Dealer Address	
Dealer Phone No.	
Model No.	
Serial No.	

About Copyright

Unauthorized copying, broadcasting, public performance and lending of discs are prohibited. This product incorporates copyright protection technology that is protected by U.S. patents and other intellectual property rights. Use of this copyright protection technology must be authorized by Macrovision, and is intended for home and other limited viewing uses only unless otherwise authorized by Macrovision. Reverse engineering or disassembly is prohibited.





U. S. Patent Nos, 4,631,603, 4,819,098, 4,907,093, 5,315,448 and 6,516,132.

Notice for the Progressive Scan Outputs

Consumers should note that not all high definition television sets are fully compatible with this product and may cause artifacts to be displayed in the picture. In case of picture problems with 480 (525) or 576 (625) progressive scan output, it is recommended that the user switch the connection to the 'standard definition' output. If there are questions regarding your TV set compatibility with this 480p (525p) or 576p (625p) DVD player, please contact our customer service center.

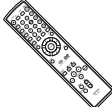
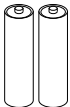
Supplied Accessories

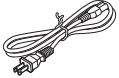
Please check to make sure the following items are included with the main unit in the carton.

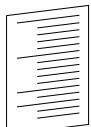
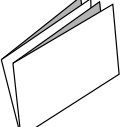
Remote control •• 1 	"AA" (R6P) batteries •••••• 2 	Audio cable••••• 1 	Video cable •• 1 	AC cord •••••• 1 	Operating Instructions •••••• 1 	Service Station List••••• 1 	Warranty Card••• 1 
--	--	---	---	---	--	--	---

Symbols Used in this Manual

The following symbols appear below in some headings and notes in this manual, with the following meanings.

DVD-V : Description refers to playback of DVD-Video discs. (including DVD-R/RW discs)

MP3 : Description refers to playback of discs formatted with MP3.

DVD-A : Description refers to playback of DVD-Audio discs.

JPEG : Description refers to viewing of JPEG discs.

CD : Description refers to playback of Audio CDs.

WMA : Description refers to playback of discs formatted with WMA.

Super Audio CD : Description refers to playback of Super Audio CDs.

DivX® : Description refers to playback of discs formatted with DivX®.

A NOTE ABOUT RECYCLING

This product's packaging materials are recyclable and can be reused. Please dispose of any materials in accordance with your local recycling regulations.

Batteries should never be thrown away or incinerated but disposed of in accordance with your local regulations concerning chemical wastes.



Make your contribution to the environment!!!

- Used up batteries do not belong in the dust bin.
- You can dispose of them at a collection point for used up batteries or special waste. Contact your council for details.

Playable Discs

Playable discs	Mark (logo)	Region code	Recorded signals	Disc size	Disc types
DVD-Audio * 1, 2, 4		—	Digital audio + Digital video (MPEG2)	12 cm or 8 cm	
DVD-Video * 1, 2, 4		or	Digital video (MPEG2)	12 cm or 8 cm	 MP3, JPEG, WMA, DivX®
DVD-R DVD-RW * 1, 2, 3, 4, 5, 6, 7, 8	 		Digital picture (JPEG), WMA*8, DivX® (DVD-R/RW only)		
Super Audio CD * 2, 4		—	Digital audio	12 cm or 8 cm	Super Audio CD or Audio CD
Audio CD * 2, 4		—	Digital audio		 Example Track 1, 2, 3, 4, 5, 6
CD-R CD-RW * 2, 3, 4, 6, 7, 8	 	—	Digital audio MP3, WMA*8 Digital picture (JPEG), DivX®		
Picture CD * 2, 3, 4, 6, 7		—	JPEG	12 cm	 Example Track 1, 2, 3, 4, 5, 6

is a trademark of DVD Format/Logo Licensing Corporation. is trademark of Eastman Kodak Company.



DivX, DivX Ultra Certified, and associated logos are trademarks of DivX, Inc. and are used under license.

If you cannot play back a disc which bears one of the marks above, check the following notes.

- *1: Certain DVD discs do not operate as described in this manual due to the intentions of the disc's producers.
 - *2: Scratched or stained discs may not be played back.
 - *3: Some discs cannot be played back because of incompatible recording conditions, characteristics of the recorder or special properties of discs.
 - *4: You can play back discs which bear the marks above. If you use nonstandardized discs, this unit may not play them back. Even if they are played back, the sound or video quality will be compromised.
 - *5: Only the discs recorded in the video format and finalized can be played back. Unfinalized discs cannot be played back. Depending on the recording status of a disc, the disc may not be played back at all or normally (the picture or sound may be distorted, etc.).
 - *6: If there is too much recordable space left on a disc (the used portion is less than 2-3/16 inches (55mm across)), it may not be played back properly.
 - *7: Do not glue paper or put stickers on to the disc. These may damage the disc, and the unit may not read it correctly.
 - *8: This player cannot play back the disc contents protected by Windows Media Digital Rights Management (DRM).
- **NEVER play back the following discs. Otherwise, malfunction may result!**
 DVD-RAM / CD-i / Photo CD / Video CD / DVD with region codes other than 1 or ALL / DVD-ROM for personal computers / CD-ROM for personal computers
 - Any other discs without compatibility indications

CAUTION:

- Use caution not to pinch your finger in the disc slot.
- Be sure to remove a disc and unplug the AC power cord from the outlet before carrying the DVD player.

● **Progressive Scan system**

The progressive scan system provides less flickering and images in higher resolution than that of traditional 480i (525i), 576i (625i) or multi television signals through the interlace scan system.

● **TV Type**

Use this to set your TV's video format (MULTI, NTSC or PAL).

● **Analog 5.1-channel Dolby and DTS surround output**

This player is equipped with analog 5.1-channel Dolby and DTS surround audio out jacks for playback.

● **HDMI (High-Definition Multimedia Interface)**

You can enjoy clearer video output when connecting this player to a display equipment with an HDMI-compatible port.

● **Dialog Speed**

Playback in slightly faster or slower speed while keeping the sound quality as in the normal playback. Dialog speed is available only on discs recorded in the Dolby Digital format.

● **Still/Fast/Slow/Step playback**

Various playback modes are available including still pictures, fast forward/reverse, slow motion and step frames.

● **Still Mode**

The resolution of pictures while in the still (pause) mode can be adjusted.

● **Random Playback for Audio CD, Super Audio CD, MP3, JPEG, DVD-Audio and WMA**

This player can shuffle the playback order of tracks in random order.

● **Program Playback for Audio CD, Super Audio CD, MP3, JPEG, DVD-Audio and WMA**

You can program the playback order of tracks in a desired order.

● **DVD menus in a desired language**

You can display DVD menus in a desired language, if available on a DVD.

● **Auto Power Off**

The power turns off automatically if there is no activity at the player or its remote for more than 30 minutes (refer to page 31).

● **Subtitles in a desired language**

You can select a desired language for subtitles if that language is available on the DVD and DivX®.

● **Selecting a camera angle**

You can select a desired camera angle if a disc contains sequences recorded from different angles.

● **Choices for audio language and sound mode**

You can select a desired audio language and sound mode if different languages and modes are available on a disc.

● **Ratings Control (Parental lock)**

You can set the control level to limit playback of discs which may not be suitable for children.

● **Super Audio CD multi-channel playback compatibility**

In addition to playing DVD-Video and DVD-Audio discs, this player can play multi-channel Super Audio CDs and a maximum of 5.1 channels can be output.

● **Automatic detection of discs**

This player automatically detects if a loaded disc is DVD-Video, DVD-Audio, Audio CD, Super Audio CD, MP3, JPEG, WMA or DivX®.

● **Pure Direct**

The sound quality of analog audio output is improved by turning off HDMI output, video signal output, and the front panel display.

● **Direct Search**

You can search the desired title, chapter, and track with numeric button during playback or in stop mode.

● **On-screen display**

Information about the current operation can be displayed on a TV screen, allowing you to confirm the currently active functions (such as program playback) using the remote control.

● **Dimmer**

The brightness of the front panel display can be adjusted.

● **Screen Saver**

The screen saver program starts if there is no activity at the player or its remote for more than 5 minutes. The brightness of the display is darkened by 75%. The program is deactivated when there is any activity.

● **Picture Control**

Picture Control adjusts Brightness, Contrast, Color, Gamma Correction and Sharpness of the specific display.

● **Search**

Chapter search: Search for a desired chapter.
 Title search: Search for a desired title.
 Group search: Search for a desired group.
 Page search: Search for a desired page.
 Track search: Search for a desired track.
 Time search: Search for a desired time point or a title or a track.

● **Repeat**

Chapter : Repeated playback of a chapter of the disc.
 Title : Repeated playback of a title of the disc.
 Track : Repeated playback of a track of the disc.
 All : Repeated playback of the entire disc. (exclude DVD-Video)
 A-B : Repeated playback of a part between two points.
 Group : Repeated playback of a folder of the DVD-Audio/MP3/JPEG/WMA/DivX® disc being played is possible.

● **Zoom**

2-time or 4-time magnified image can be displayed.

● **Marker**

Electric reference points designated by user can be called back.

● **Resume Playback**

User can resume playback from the point at which the playback has been stopped even if the power is turned off.

● **COMPONENT VIDEO OUT Jacks**

Jacks located on the back of the DVD Player which are used to send high-quality video to a TV via Component Video In Jacks.

● **Bit rate indication**

● **DRC (Dynamic Range Control)**

You can control the range of sound volume.

● **Displaying a JPEG picture**

Kodak Picture CDs can be played back. Still images stored in JPEG format on DVD-R/RW or CD-R/RW can also be played back.

● **Reproducing WMA data**

You can enjoy WMA files which are recorded on DVD-R/RW or CD-R/RW.

● **Playing back an MP3 disc**

You can enjoy MP3 files which are recorded on DVD-R/RW or CD-R/RW.

● **Reproducing DivX® data**

You can enjoy DivX® files which are recorded on DVD-R/RW or CD-R/RW.
 • Official DivX® Ultra Certified product
 • Plays all versions of DivX® video (including DivX® 6) with enhanced playback of DivX® media files and the DivX Media Format.

“WMA” (Windows Media Audio) is an audio codec developed by Microsoft® in the United States of America.

FUNCTIONAL OVERVIEW

FRONT PANEL

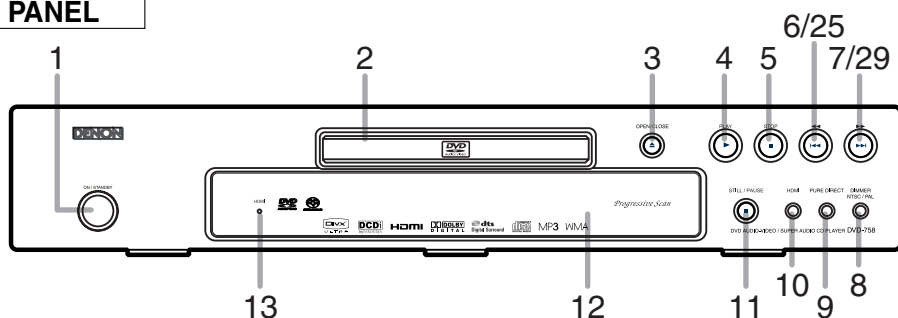

REMOTE CONTROL

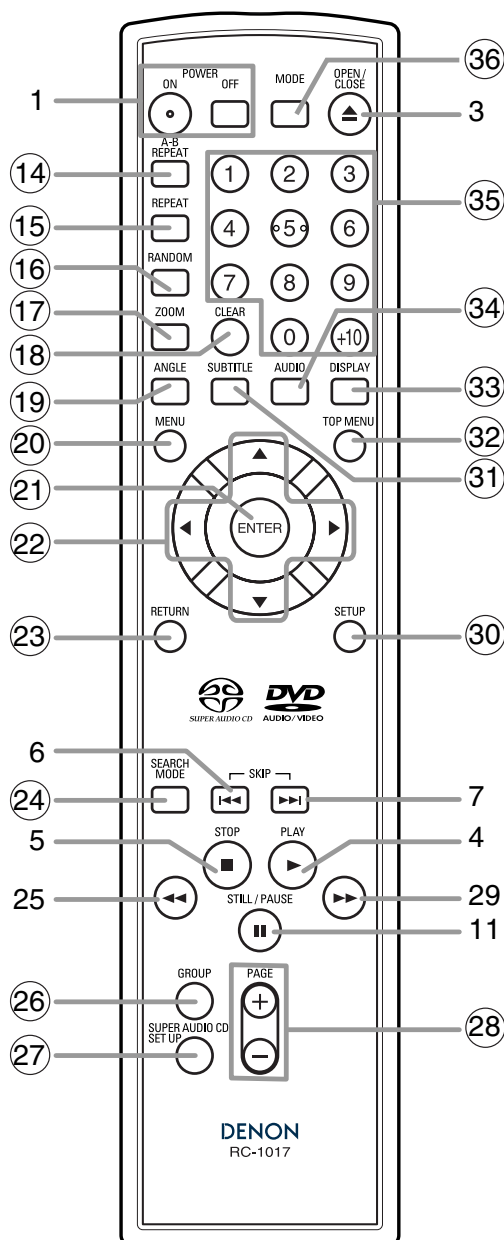















1. **ON/STANDBY (POWER ON/OFF) Buttons** [page 17]
2. **Disc loading tray**
3. **OPEN/CLOSE Button** [page 17]
4. **PLAY Button** [page 17]
5. **STOP Button** [page 17]
6. **◀◀(SKIP DOWN) Button** [page 19]
7. **▶▶(SKIP UP) Button** [page 19]
8. **DIMMER NTSC/PAL Button** [page 17]
9. **PURE DIRECT Button** [page 17]
Press to activate Pure Direct function to reduce noise level.
10. **HDMI Button** [page 17]
Press to set the HDMI connector's video signal output mode.
11. **STILL/PAUSE Button** [page 18]
12. **Display, Remote Sensor Window**
13. **HDMI indicator** [page 17]
Lights up when there is video signal output from the HDMI OUT jack.
14. **A-B REPEAT Button** [page 20]
15. **REPEAT Button** [page 20]
16. **RANDOM Button** [pages 21]
17. **ZOOM Button** [page 19]
18. **CLEAR Button** [page 19]
19. **ANGLE Button** [page 26]
20. **MENU Button** [page 18]
21. **ENTER Button** [page 17]
22. **Cursor Buttons** [page 17]
23. **RETURN Button** [page 20]
24. **SEARCH MODE Button** [page 19]
25. **◀◀(Fast Reverse SEARCH) Button** [page 18]
Press more than 2 seconds when you use the front panel button for this function.
26. **GROUP Button** [page 18]
27. **SUPER AUDIO CD SET UP Button** [page 27]
28. **PAGE Buttons** [page 18]
29. **▶▶(Fast Forward SEARCH) Button** [page 18]
Press more than 2 seconds when you use the front panel button for this function.
30. **SETUP Button** [page 28]
31. **SUBTITLE Button** [page 26]
32. **TOP MENU Button** [page 18]
33. **DISPLAY Button** [page 24]
34. **AUDIO Button** [page 26]
35. **Numeric Buttons** [page 17]
36. **MODE Button** [page 21]





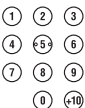







The buttons with circled numbers can only be operated with the remote control.

Tour of the Remote Control

Buttons on remote control work in different ways for DVD-Video, DVD-Audio, Audio CD, Super Audio CD, MP3, JPEG, WMA and DivX®: Refer to the following table for correct use.

	DVD-Video, DVD-Audio	CD, Super Audio CD, MP3, JPEG, WMA	DivX®
POWER ON/OFF Buttons 	<ul style="list-style-type: none"> To turn on or standby the unit. 	<ul style="list-style-type: none"> To turn on or standby the unit. 	<ul style="list-style-type: none"> To turn on or standby the unit.
A-B REPEAT Button 	<ul style="list-style-type: none"> To mark a segment between A and B for repeated playback. 	<ul style="list-style-type: none"> To mark a segment between A and B for repeated playback. (CD, Super Audio CD) 	<ul style="list-style-type: none"> To mark a segment between A and B for repeated playback.
REPEAT Button 	<ul style="list-style-type: none"> To repeat playback of a title, chapter, group or track. 	<ul style="list-style-type: none"> To repeat playback of a track or disc. (CD, Super Audio CD) To repeat playback of a track, group, or disc. (MP3, JPEG, WMA) 	<ul style="list-style-type: none"> To repeat playback of a track, group or disc. (DivX® media files) To repeat playback of a title or chapter. (DivX® video files)
RANDOM Button 	<ul style="list-style-type: none"> To shuffle the playing order of groups and tracks. (DVD-Audio) 	<ul style="list-style-type: none"> To play back tracks in random order. 	<p>—</p>
MODE Button 	<ul style="list-style-type: none"> To set Picture Control. To set Black Level on/off. To activate the 3D sound (Virtual surround system). To set Dialog Speed. To program a specific playback order. (DVD-Audio) To play all groups. (DVD-Audio) 	<ul style="list-style-type: none"> To program a specific playback order. To activate the 3D sound (Virtual surround system). (CD, MP3, WMA) To activate the Slide Show mode. (JPEG) 	<ul style="list-style-type: none"> To set Picture Control. To set Black Level on/off.
ZOOM Button 	<ul style="list-style-type: none"> To magnify part of the picture (x2/x4). 	<ul style="list-style-type: none"> To magnify part of the picture (x2). (JPEG) 	<ul style="list-style-type: none"> To magnify part of the picture (x2).
ANGLE Button 	<ul style="list-style-type: none"> To select a camera angles on the disc. 	<ul style="list-style-type: none"> To rotate a picture. (JPEG) 	<p>—</p>
SUBTITLE Button 	<ul style="list-style-type: none"> To select a subtitle language on the disc. 	<p>—</p>	<ul style="list-style-type: none"> To select a subtitle language on the disc.
AUDIO Button 	<ul style="list-style-type: none"> To access various audio functions on the disc. 	<ul style="list-style-type: none"> To select STEREO, L-ch or R-ch. (CD) 	<ul style="list-style-type: none"> To access various audio functions on the disc.
DISPLAY Button 	<ul style="list-style-type: none"> To display the current disc or HDMI mode. 	<ul style="list-style-type: none"> To display the current disc or HDMI mode. 	<ul style="list-style-type: none"> To display the current disc or HDMI mode.
SEARCH MODE Button 	<ul style="list-style-type: none"> To search for a title, chapter, track, time or marker. To rapidly return to a location on the disc. 	<ul style="list-style-type: none"> To search for a track. To search for time or a marker. (CD, Super Audio CD) To rapidly return to a location on the disc. (CD, Super Audio CD) 	<ul style="list-style-type: none"> To search for a track, or time. (DivX® media files) To search for a chapter, title or time. (DivX® video files)
OPEN/CLOSE Button 	<ul style="list-style-type: none"> To open or close the disc tray. 	<ul style="list-style-type: none"> To open or close the disc tray. 	<ul style="list-style-type: none"> To open or close the disc tray.
Numeric Buttons 	<ul style="list-style-type: none"> To select a title, chapter, group or track directly. 	<ul style="list-style-type: none"> To select a track directly. 	<ul style="list-style-type: none"> To select a track directly. (DivX® media files) To select a chapter or title directly. (DivX® video files)
CLEAR Button 	<ul style="list-style-type: none"> To clear the markers. To clear the most recently entered track for the program playback. (DVD-Audio) To clear the numbers entered incorrectly. To cancel the point for A-B Repeat. 	<ul style="list-style-type: none"> To clear the markers. (CD, Super Audio CD) To clear the most recently entered track for the program playback. To clear the numbers entered incorrectly. To cancel the point for A-B Repeat. (CD, Super Audio CD) 	<ul style="list-style-type: none"> To clear the numbers entered incorrectly. To cancel the point for A-B Repeat.

Tour of the Remote Control

	DVD-Video, DVD-Audio	CD, Super Audio CD, MP3, JPEG, WMA	DivX®
MENU Button 	<ul style="list-style-type: none"> To call up the menu on a disc. 	<ul style="list-style-type: none"> To call up the file list. (MP3, JPEG, WMA) 	<ul style="list-style-type: none"> To call up the file list.
TOP MENU Button 	<ul style="list-style-type: none"> To call up the top menu on a disc. 	<ul style="list-style-type: none"> To return to the top file in the highest hierarchy of the file list. (MP3, JPEG, WMA) 	<ul style="list-style-type: none"> To call up the menu on a file. (DivX® video files) To return to the top file in the highest hierarchy of the file list.
ENTER, Cursor Buttons 	<ul style="list-style-type: none"> To move the cursor and determine its position. 	<ul style="list-style-type: none"> To move the cursor and determine its position. 	<ul style="list-style-type: none"> To move the cursor and determine its position.
RETURN Button 	<ul style="list-style-type: none"> To return to the previous operation in the setup menu. 	<ul style="list-style-type: none"> To return to the previous operation in the setup menu. 	<ul style="list-style-type: none"> To return to the previous operation in the setup menu.
SETUP Button 	<ul style="list-style-type: none"> To call up the setup menu. 	<ul style="list-style-type: none"> To call up the setup menu. 	<ul style="list-style-type: none"> To call up the setup menu.
SKIP Buttons 	<ul style="list-style-type: none"> To skip titles/chapters/tracks. 	<ul style="list-style-type: none"> To skip tracks. 	<ul style="list-style-type: none"> To skip tracks. (DivX® media files) To skip chapters. (DivX® video files)
SEARCH Buttons 	<ul style="list-style-type: none"> To search forward/backward through a disc. To begin slow forward/slow reverse. 	<ul style="list-style-type: none"> To search forward/backward through a disc. (except JPEG) 	<ul style="list-style-type: none"> To search forward/backward through a disc. To begin slow forward.
STOP Button 	<ul style="list-style-type: none"> To stop playback. 	<ul style="list-style-type: none"> To stop playback. 	<ul style="list-style-type: none"> To stop playback.
PLAY Button 	<ul style="list-style-type: none"> To begin playback. 	<ul style="list-style-type: none"> To begin playback. 	<ul style="list-style-type: none"> To begin playback.
STILL/PAUSE Button 	<ul style="list-style-type: none"> To pause playback. To advance playback frame by frame. 	<ul style="list-style-type: none"> To pause playback. 	<ul style="list-style-type: none"> To pause playback. To advance playback frame by frame.
GROUP Button 	<ul style="list-style-type: none"> To begin playback from a desired group. (DVD-Audio) 	—	—
SUPER AUDIO CD SET UP Button 	—	<ul style="list-style-type: none"> To select the Super Audio CD setup. (Super Audio CD) 	—
PAGE Buttons 	<ul style="list-style-type: none"> To select a desired background display image for playback. (DVD-Audio) 	—	—

Front Panel Display

Lights up when the progressive scan system is activated.
 Lights up when the disc playback comes to a pause.
 Lights up when playing back in slow mode. (DVD, DivX®)
 Lights up when the inserted disc is being play back.
 The present display state is shown.
 • TL./GR.: Title or Group
 • TR./CP.: Track or Chapter
 To change to the display of a title press the **DISPLAY** button in the state of Resume.
 Displays the chapter (title) or track number. In case the chapter (title) or track number is over 100, displays “-”.

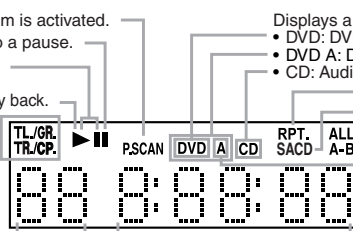

Displays a type of the disc which is on the tray.
 • DVD: DVD-Video, MP3, JPEG, WMA, DivX® on DVD-R/RW
 • DVD A: DVD-Audio
 • CD: Audio CD, MP3, JPEG, WMA, DivX® on CD-R/RW
 Lights up when the repeat function is on.
 SACD: Super Audio CD

Lights up when the ALL repeat function is on.
 Lights up when the A-B repeat function is on.
 Lights up when you have selected the audio file (CD/MP3/WMA/DVD-Audio) on the program screen.

Displays the elapsed time of the chapter (title) or track. (The display of 10 hours or more cannot be performed.) Selected HDMI output mode is displayed.

Displays during Operation

	Power on
	Power off
	Tray open
	Tray closed
	Loading the Disc
	No disc inserted or cannot read
	HDMI output mode (480p/576p) is selected (576p is displayed after 480p)
	HDMI output mode (720p) is selected
	HDMI output mode (1080i) is selected
	HDMI output mode (1080p) is selected
	HDMI output mode (OFF) is selected
	Super Audio CD setup (2CH AREA) selected
	Super Audio CD setup (MULTI-CH AREA) selected
	Program playback is set
	Program playback setting group (folder) is selected
	Program playback setting ALL CLEAR is selected
	Random playback is set
	All group playback setting

NOTES:

- The front panel display has blinked while setting the program playback.
- "P**●●●" is displayed in the front panel display while setting the program playback. ("**" is program number, "●●●" is track number.)
- "A" is displayed in front panel display while selecting the audio file (CD, MP3, WMA, DVD-Audio).
- "F-***" is displayed in the front panel display while selecting the group (folder). ("***" is group (folder) number.)
- "A-CLEAR" is displayed in the front panel display while selecting ALL CLEAR.
- "SHUFFLE" is displayed in the front panel display while setting the random playback.
- "A-PLAY" is displayed on the front panel display while setting the all group playback.

Loading the Batteries

1. Open the battery compartment cover.
2. Insert two "AA" (R6P) batteries, with each one oriented correctly.
3. Close the cover.

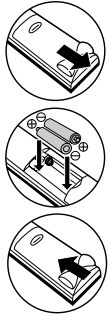

Cautions On Batteries

- Use "AA" (R6P) batteries in this remote control unit.
- Replace the batteries with new ones approximately once a year, though this depends on the frequency with which the remote control unit is used.
- If the remote control unit does not operate within a close proximity of the main unit, replace the batteries with new ones, even if less than a year has passed.
- The included batteries serve only for verifying operation. Replace them with new batteries as soon as possible.
- When inserting the batteries, be careful to do so in the proper direction, following the ⊕ and ⊖ marks in the remote control unit's battery compartment.
- To prevent damage or battery fluid leakage:
 - Do not mix a new battery with an old one.
 - Do not mix two different types of batteries such as alkaline and manganese.
 - Do not short-circuit, disassemble, heat or dispose of batteries in flames.
- Remove the batteries when not planning to use the remote control unit for a long period of time.
- If the batteries should leak, carefully wipe off the fluid from the inside of the battery compartment, then insert new batteries.

Using a Remote Control

- Keep in mind the following when using the remote control:
- Make sure that there are no obstacles between the remote control and the remote sensor on the unit.
 - Remote operation may become unreliable if strong sunlight or fluorescent light is shining on the remote sensor of the unit.
 - Remote control for different devices can interfere with each other. Avoid using remote control for other equipment located close to the unit.
 - Replace the batteries when you notice a fall off in the operating range of the remote control.
 - The maximum operable ranges from the unit are as follows.
 - **Line of sight:** approx. 23 feet (7m)
 - **Either side of the center:** approx. 16 feet (5m) within 30°
 - **Above:** approx. 16 feet (5m) within 15°
 - **Below:** approx. 10 feet (3m) within 30°

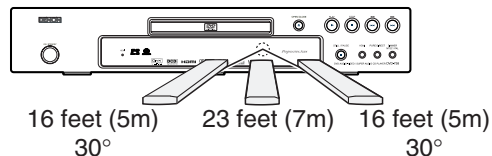

CONNECTIONS

Description - Rear Panel

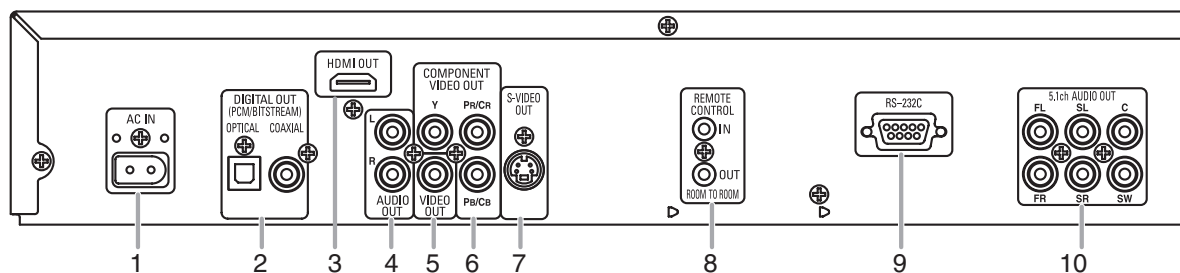

- 1. AC IN Terminal**
Connects the AC cord to supply the power.
- 2. DIGITAL OUT Jacks (OPTICAL, COAXIAL)**
Use either an optical or coaxial digital cable (commercially available) to connect to an AV amplifier with a built-in decoder (AV control center).
- 3. HDMI OUT Jack**
Use an HDMI connection cable (commercially available) to connect to a display with an HDMI compatible port.
- 4. AUDIO OUT Jacks**
Connect to the Audio input jacks of A/V-compatible TV or wide screen TV or Stereo system.
- 5. VIDEO OUT Jack**
Use a video cable to connect one of the jacks to Video input on your A/V-compatible TV or wide screen TV.
- 6. COMPONENT VIDEO OUT Jacks**
Use a Component Video cable (commercially available) to connect these jacks if you have a TV with Component Video in jacks. These jacks provide C_b/P_b, C_r/P_r and Y video. Along with S-Video, Component Video provides the best quality picture.
- 7. S-VIDEO OUT Jack**
Use the S-Video cable (commercially available) to connect this jack to the S-Video jack on your A/V-compatible TV or wide screen TV for a higher quality picture.
- 8. REMOTE CONTROL IN/OUT Jacks**
Connecting the DENON Satellite Remote Control to these jacks enables you to operate more than one DENON components with one remote control.
- 9. CONTROL CONNECTOR (RS-232C)**
This is a terminal for future system expansion.
- 10. 5.1ch AUDIO OUT Jacks**
Use speaker cables (commercially available) to connect these jacks to the 5.1 ch Audio input jacks of your AV amplifier with 5.1-channel input terminals.

When using the DENON Satellite Remote Control,

- Connect the DENON Satellite Remote Control to the REMOTE CONTROL IN jack of this player. This allows you to operate this player with the Satellite Remote Control.
- Connect another DENON component to the REMOTE CONTROL OUT jack of this player. This allows you to operate this player and the connected component with the same Satellite Remote Control.

Selecting Progressive Scan (480p/576p or Interlaced 480i/576i) Playback

- If your TV is compatible with progressive scanning (480p/576p), connect the TV to the COMPONENT VIDEO OUT jacks of the DVD player and set PROGRESSIVE to ON in the display setting. Next, set your TV to the progressive scan mode. Refer to page 28 for instructions on changing the display setting. P.SCAN will appear on the display of the unit.
- If your TV is not compatible with progressive scanning, set PROGRESSIVE to OFF (refer to page 28). Make sure that P.SCAN on the display of the unit lights off.
- Use a commercially available adaptor if the video input jacks of your TV or monitor is the BNC type.
- Progressive video signal will not be output from the COMPONENT VIDEO OUT while using the HDMI OUT jack.

What is Progressive Scanning?

- Unlike conventional interlace scanning, the progressive scan system provides less flickering and images in higher resolution than that of traditional (480i/576i) television signals.

The DCDi (Directional Correlational Deinterlacing) system of this DVD player produces smooth and natural video images, even if really dynamic, by eliminating the jagged edges. **DCDi** is a trademark of Faroudja, a division of Genesis Microchip Inc.

Manufactured under license from Dolby Laboratories. "Dolby" and the double-D symbol are trademarks of Dolby Laboratories.

Manufactured under license under U.S. Patent #'s: 5,451,942; 5,956,674; 5,974,380; 5,978,762; 6,487,535 & other U.S. and worldwide patents issued & pending. DTS and DTS Digital Surround are registered trademarks and the DTS logos and Symbol are trademarks of DTS, Inc. © 1996-2007 DTS, Inc. All Rights Reserved.

CONNECTIONS

The following shows examples of connections commonly used to connect the DVD player to TV and other components.

If using this DVD player to play back a DVD in a Dolby Digital Multi-channel surround or DTS surround format, the DVD player outputs a Dolby Digital or DTS data stream from its OPTICAL or COAXIAL DIGITAL OUT jacks. By hooking up the player to a Dolby Digital or DTS decoder, you can enjoy more convincing, realistic ambience with powerful and high-quality surrounding sound of a professional standard which can be heard in movie theaters. Use a commercially available audio optical or coaxial digital cable (not included) for the audio connections.

NOTES:

- Be sure to turn off the power of all components in the system before connecting another component.
- Refer to the Instruction Manuals for your TV, stereo system and any other components to be connected to the DVD player.

Connection to an Audio System

Method 1

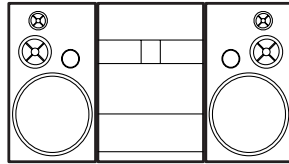

Stereo system

Method 2



AV amplifier with a built in decoder (AV control center), Dolby Digital decoder, DTS decoder, MD deck or DAT deck

AUDIO

Audio Input Jacks

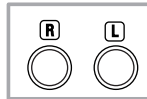

Audio cable (supplied)

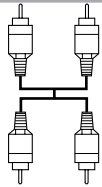

Digital Audio Input Jacks

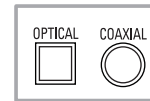

Optical cable (commercially available)

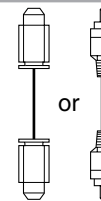

Audio Coaxial Digital cable (commercially available)

DVD

AUDIO OUT (analog)



DIGITAL OUT

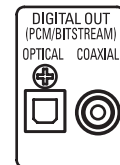

- **Method 1** DVD Player + Stereo system
- **Method 2** DVD Player + AV amplifier with a built in decoder (AV control center), Dolby Digital decoder, DTS decoder, MD deck or DAT deck

NOTES (for Method 2 only):

- When using an AV amplifier with a built in decoder (AV control center), Dolby Digital, or DTS decoder as shown in the Method 2, set DOLBY DIGITAL or DTS to BITSTREAM accordingly for audio output in the setup mode (refer to page 29). Set it to PCM for the decoder that is not used currently. Playing back a DVD using incorrect settings may generate noise distortion, and may also damage the speakers.
- The audio source on a disc in a Dolby Digital Multi-channel surround format cannot be recorded as digital sound by an MD deck or DAT deck.
- Set DOLBY DIGITAL or DTS to PCM for audio output in the setup mode for connecting to an MD deck or DAT deck (refer to page 29).
- Harsh noise that could harm your ears or the speakers is generated when a DVD recorded in DTS is played while using a decoder, etc., that is not DTS-compatible.
- When playing back a copyright-protected 96kHz PCM DVD, the digital sound will be down sampled at 48kHz, even if you set LPCM SELECT to OFF (refer to page 29).
- Super Audio CD sound is not output from the DIGITAL OUT jacks.

Optical cable (commercially available)

- Optical cable (commercially available) may be damaged when bent at sharp angles. Ensure cables are coiled in loops with a diameter of 6 inches (15cm) or more when storing them.
- Use a cable which is 9.8 feet (3m) or shorter.
- Insert cable plugs firmly into the connectors when making connections.
- If a plug has dust or is dirty, clean it with a soft cloth before inserting it into a connector.

Connection to 5.1-channel Surround Sound System

Analog 5.1-channel audio signals can be output from the DVD player. The multi-channel audio signals recorded in packed PCM and the multi-channel Super Audio CDs can be played back when an AV amplifier equipped with analog 5.1-channel audio inputs is connected.

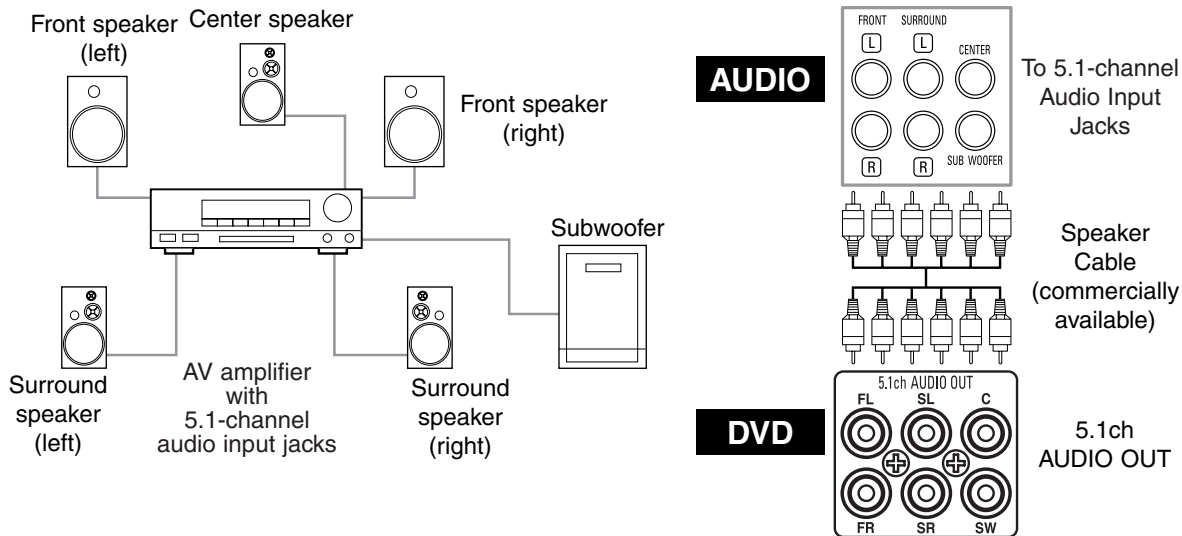

NOTES:

- For 5.1-channel connections, set ANALOG AUDIO to MULTI CHANNEL in the setup mode and adjust Speaker Configuration, DELAY TIME and CHANNEL LEVEL settings (refer to page 30).
- You can enjoy high-quality analog sound by cutting off the video signal. Press the **PURE DIRECT** button on the front panel.

Connection to a TV (for video)

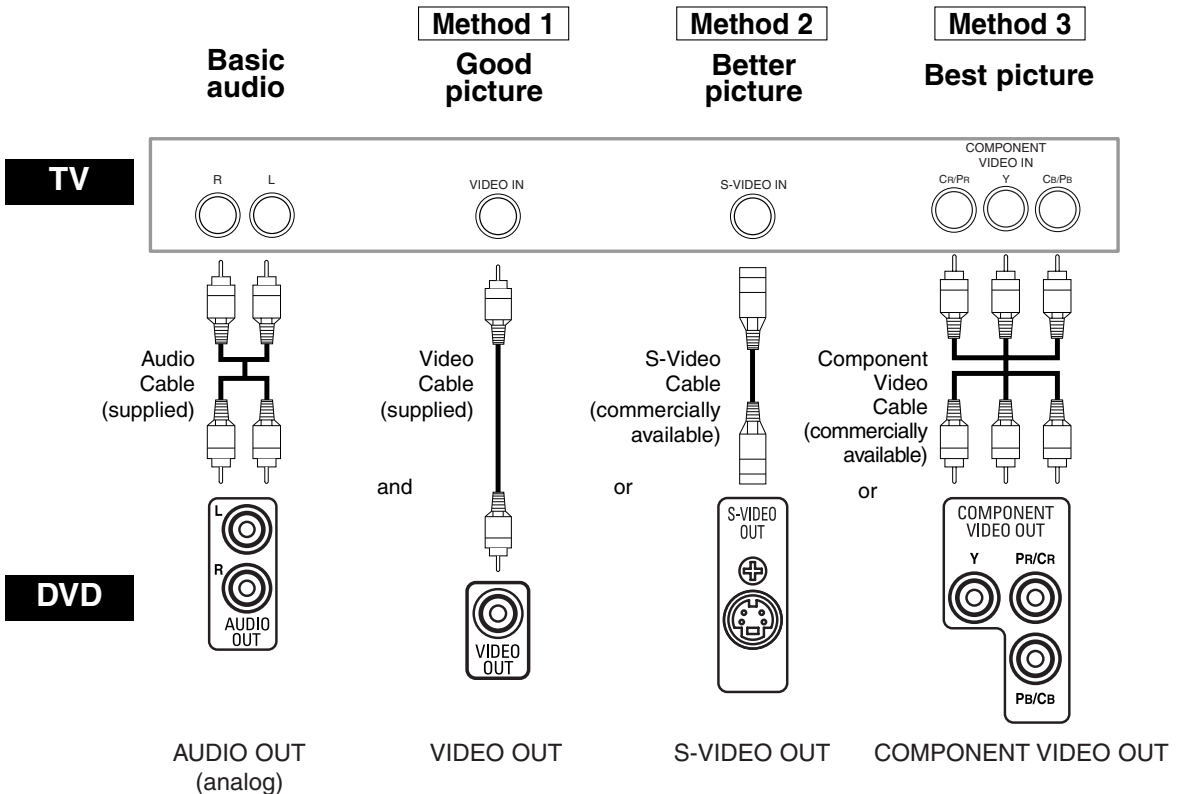

- **Method 1** DVD Player + TV with Video Input Jack
- **Method 2** DVD Player + TV with S-Video Input Jack
- **Method 3** DVD Player + TV with Component Video Input Jacks

NOTES:

- Connect the DVD player directly to a TV. If the Audio/Video cables are connected to a VCR, pictures may be distorted due to the copy protection system.
- S-Video output connector
The video signals are divided into color (C) and brightness (Y) signals, achieving a clearer picture.
If the TV is equipped with a S-Video input connector, we recommend connecting it to this unit's S-Video output connector using a commercially available S-Video connection cord.

HOW TO CONNECT TO A TV WITHOUT AUDIO/VIDEO INPUT JACKS

If your TV does not have RCA type audio and video input jacks it is still possible to connect this DVD player to your TV's 75-ohm coaxial antenna terminal using an optional Stereo Audio/Video RF Modulator, not included. Connect the audio and video outputs of the DVD player to the audio and video inputs on the RF Modulator, and then connect the coaxial output of the RF Modulator (usually marked "TO TV") to the 75 ohm coaxial antenna terminal on your TV. Follow the instruction supplied with the RF Modulator for more details.
If your TV's 75 ohm coaxial antenna terminal is already occupied by an antenna or cable box connection, remove that cable from your TV's antenna terminal and reconnect it to the coaxial antenna input terminal of the RF Modulator (usually marked "ANT IN"), then connect the RF modulator to your TV's antenna terminal as described above.

NOTE:

- The picture quality from DVD discs will not be as good if the DVD player is connected to the TV's antenna terminal through an RF Modulator.

CONNECTIONS

Connection to a TV with an HDMI Compatible Port

A simple 1-cable connection (using a commercially available cable) with a device having an HDMI (High-Definition Multimedia Interface) connector allows digital transfer of the digital images of DVD-Video and other sources, DVD-Video, and the multi-channel sound of DVD-Audio.

HDMI™
HIGH DEFINITION MULTIMEDIA INTERFACE

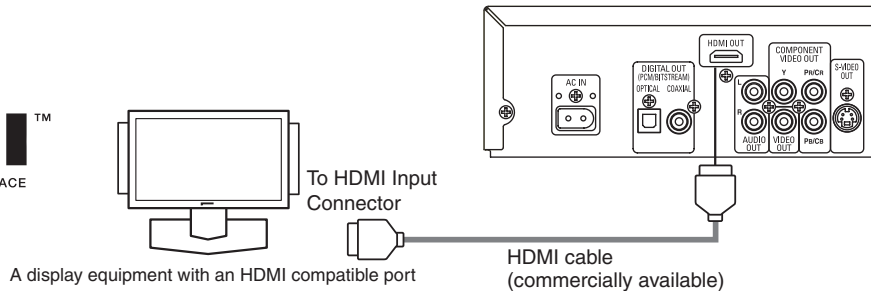

Actual output modes by media

		HDMI AUDIO Setting			
		2 CHANNEL		MULTI CHANNEL	
		DOLBY DIGITAL/DTS Setting		DOLBY DIGITAL/DTS Setting	
	Audio Recording Format	BITSTREAM *1	PCM	BITSTREAM *1	PCM *2
DVD-Video	Dolby Digital	Dolby Digital	2channel PCM	Dolby Digital	Multi PCM
	DTS	DTS	2channel PCM	DTS	Multi PCM
	LPCM	2channel PCM	2channel PCM	Multi PCM	Multi PCM
DVD-Audio	LPCM or PPCM (with CPPM) *3 *5	2channel PCM	2channel PCM	Multi PCM	Multi PCM
	LPCM or PPCM (without CPPM)	2channel PCM	2channel PCM	Multi PCM	Multi PCM
DivX®	Dolby Digital	Dolby Digital	2channel PCM	Dolby Digital	2channel PCM
	MP3/MP2	2channel PCM	2channel PCM	2channel PCM	2channel PCM
Audio CD		2channel PCM	2channel PCM	2channel PCM	2channel PCM
MP3/WMA		2channel PCM	2channel PCM	2channel PCM	2channel PCM
Super Audio CD	MULTI-CH AREA *4	—	—	—	—
	2CH AREA *4	—	—	—	—
	CD AREA	2channel PCM	2channel PCM	2channel PCM	2channel PCM

*1 If the connected equipment is not compatible with HDMI BITSTREAM, signals are output on PCM.

*2 If the connected equipment is not compatible with HDMI Multi PCM, signals are output on down mixed PCM.

*3 If the connected equipment is not compatible with HDMI ver. 1.0, signals are not output.

*4 Sounds recorded on the MULTI-CH/2CH AREA of Super Audio CDs are not output.

*5 Transfer of signal from DVD audio discs that are copyright-protected by CPPM is only possible if both devices are HDMI Ver.1.1 compatible. This player is HDMI Ver.1.3 compatible.

Copyright protection system

To play back the digital video images of a DVD via an HDMI connection, it is necessary that both the player and the display equipment (or an AV amplifier) support a copyright protection system called HDCP (High-bandwidth Digital Content Protection System). HDCP is copy protection technology that comprises data encryption and authentication of the connected AV equipment. This player supports HDCP. Please read the operating instructions of your display equipment (or AV amplifier) for more information.

*HDMI: High-Definition Multimedia Interface

NOTES:

- When using an HDMI-incompatible or HDCP-incompatible display equipment, the image will not be viewed properly.
- When the **PURE DIRECT** button on the front panel is turned on, not only HDMI images but sounds are not output (refer to page 17).
- Among the devices that support HDMI, some devices can control other devices via the HDMI connector; however, this player cannot be controlled by another device via the HDMI connector.
- The audio signals from the HDMI connector (including the sampling frequency, the number of channels and bit length) may be limited by the equipment that is connected.
- When playing a Super Audio CD with an HDMI connection, audio cannot be transferred beyond the CD layer. Make an analog connection for this.
- Among the monitors that support HDMI, some do not support audio output (for example, projectors). In connections with equipment such as this, audio signals are not output from the HDMI output connector.
- When the set's HDMI connector is connected to a DVI-D compatible monitor (HDCP compatible) with an HDMI-DVI converter cable (commercially available), the signals are output in digital RGB.

“HDMI, the HDMI logo and High-Definition Multimedia Interface are trademarks or registered trademarks of HDMI Licensing LLC.”

Connecting the AC Cord

After you made all necessary connections, connect the AC cord to the AC inlet. Then connect the AC cord to the AC outlet.

Basic Playback

DVD-V	DVD-A	CD	Super Audio CD	MP3
JPEG	WMA	DivX®		

Getting started

- Turn on the power of the TV, amplifier and any other components which are connected to the DVD player.
- Make sure the TV and audio receiver (commercially available) are set to the correct channel.

1 Press the **POWER ON** button.

- "P-ON" will appear briefly on the display panel.

2 Press the **OPEN/CLOSE** button to open disc loading tray.

3 Place the disc in the tray, with the label facing up.

4 Press the **PLAY** button.

- The tray will close automatically, then playback will start from the first chapter or track of the disc. If the playback does not start automatically, press the **PLAY** button.
- When you play back the DVD with a title menu, it may appear on the screen. In this case, refer to "Title menu" on page 18.

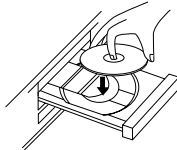

5 Press the **STOP** button to stop playback.

NOTES:

- A "prohibited icon" may appear at the top-right corner on the TV screen during operation, warning that a prohibited operation has been encountered by the DVD player or the disc.
- With DVDs that use some titles for playback program signals, playback may start from the second title, or it may skip these titles.
- During the playback of two layered disc, pictures may stop for a moment. This happens when the 1st layer switches to the 2nd layer. This is not a malfunction.
- The operation may vary when you play back DVDs with disc menu or DivX® video files. Refer to the manual accompanying the disc for details.



HDMI Setup

1 Press the **HDMI** button on the front panel to select the HDMI output mode.

The output mode changes as follows every time the **HDMI** button is pressed.

- The HDMI indicator on the front panel lights up when HDMI output mode is on.

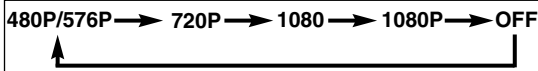

480P/576P (Default):

Video output from the HDMI OUT jack at 480p/576p.

720P: Video output from the HDMI OUT jack at 720p.

1080: Video output from the HDMI OUT jack at 1080i.

1080P: Video output from the HDMI OUT jack at 1080p.

OFF: No video output from the HDMI OUT connector.

NOTES:

- Video and audio signals may distorted temporarily when switching to/from the HDMI output mode.
- Use a display equipment with an HDMI-compatible port.
- The HDMI indicator on the front panel flashes when you select the HDMI output mode but there is no HDMI cable.
- If you turn on the pure direct mode, both video and audio signals thru the HDMI output will be cut off (press the **PURE DIRECT** button again to recover).
- You can check the HDMI connection status by pressing the **DISPLAY** button during playback with the HDMI output mode (refer to page 25).
- If the TV is not compatible with newly selected HDMI output mode, the actual output mode will be kept the one before changing the selection. When this occurs, the newly selected mode will appear on the front panel display (see page 11) while the actual output resolution will be indicated by performing the on-screen display as described in NOTE OFR HDMI DISPLAY on page 25.
- Actual output signals for each HDMI mode vary with DVD the compatibility of the connected display device.
- You cannot select the HDMI output mode when the setup menu is on the TV screen.

Pure Direct Mode

1 Press the **PURE DIRECT** button on the front panel to output an analog audio signal only (no analog video and HDMI signals will be output and the display will be turned off). The higher quality sound will be achieved.

NOTES:

- When the buttons below are pressed, the pure direct mode will be released. **OPEN/CLOSE** button (on both the remote and the front panel), **SETUP** or **DISPLAY** button (on the remote), **ON/STANDBY** or **PURE DIRECT** button (on the front panel).
- The **PURE DIRECT** button will not function while displaying the setup menu.
- If you turn on the pure direct mode while selecting HDMI mode, both video and audio signals will not be output.

Brightness of the Front Panel Display

1 Press the **DIMMER NTSC/PAL** button on the front panel to select the desired brightness of the front panel display. (BRIGHT, DIMMER or OFF)

- The default setting is BRIGHT.

NOTES:

- The brightness of the front panel display can be adjusted from the setup menu. Details are on page 31.
- When you turn on the power next time, the brightness of the front panel display will be as set in setup menu.

TV TYPE

Select a suitable video system according to the format of the TV you connected.

1 Stop playback.

2 Press the **DIMMER NTSC/PAL** button on the front panel more than 3 seconds. The video system will be displayed on the front panel display and TV screen.



3 Press the **DIMMER NTSC/PAL** button on the front panel more than 3 seconds. The video system will be displayed on the front panel display and TV screen.

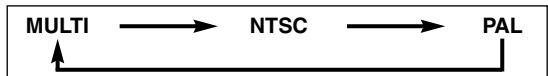

- If it is left untouched for more than 5 seconds or any other buttons are pressed, the unit will switch back to the normal status.

NOTES:

- If the video system setting does not fit to the TV you connected, the picture will be distorted.
- If you turn off the unit, the video system will go back to the one set for the TV TYPE on the display menu (refer to page 28).

General Features

DVD-V	DVD-A	DivX®
-------	-------	-------

DVD and DivX® video file may contain menus to navigate the disc and access special features. Press the appropriate **Numeric** buttons or use the **Cursor** buttons (▲ / ▼ / ◀ / ▶) to highlight your selection in the DVD main menu and press the **ENTER** button to confirm.

NOTES:

- Unless otherwise stated, all operations described in this manual are based on remote control use. Some operations can be carried out using the menu bar on the TV screen.
- The **Numeric** buttons are invalid in menu of DivX® video file.

Disc Menu

DVD-V

- 1 Press the **MENU** button.
 - The DVD main menu will appear.
- 2 If the feature is not available,  symbol may appear on the TV screen.
- 3 If disc menu is available on the disc, audio language, subtitle options, chapters for the title and other options will appear for selection.
- 4 Press the **Cursor** buttons (▲ / ▼ / ◀ / ▶) to select an item, and the **ENTER** button to confirm the selection.

Title Menu

DVD-V DVD-A

- 1 Press the **TOP MENU** button.
 - The title menu will appear.
- 2 If the feature is not available,  symbol may appear on the TV screen.
- 3 Press the **Cursor** buttons (▲ / ▼ / ◀ / ▶) to select an item, and the **ENTER** button to confirm the selection.
 - Playback will begin at the selected title.

DivX®

- 1 Press the **Cursor** buttons (▲ or ▼) to choose a track, then press the **PLAY** or **ENTER** button.
- 2 Press the **TOP MENU** button.
 - The title menu will appear.
- 3 If the title menu is available on the file, audio language, subtitle options, chapter for the title and other options will appear for selection.
- 4 Press the **Cursor** buttons (▲ / ▼ / ◀ / ▶) to select an item, and the **ENTER** button to confirm the selection.

CALLING UP A MENU SCREEN DURING PLAYBACK

DVD-V DVD-A DivX®

- Press the **MENU** button to call up the DVD main menu (DVD-V).
- Press the **TOP MENU** button to call up the title menu.

NOTES:

- Contents of menus and corresponding menu operations may vary among discs. Refer to the manual accompanying the disc for details.
- During playback or resume stop state on the DivX® video file, it is possible to call up a menu.

DVD Audio Playback

DVD-A

PLAYBACK OF ALL GROUPS

- 1 In stop mode, press the **MODE** button.
 - The all group screen appears.
- 2 Press the **PLAY** button to begin playback.

NOTE:

- "A-PLAY" is displayed in the front panel display at step 1.

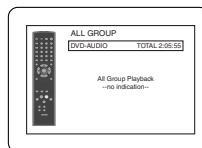

PLAYBACK FROM A DESIRED GROUP

- 1 During playback or in the stop mode, press the **GROUP** button.
- 2 Press the **Numeric** buttons to select a group.
 - The group will be located and playback will start.

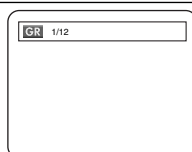

PAGE SELECTION

Some DVD-Audio discs that include still images feature a selection of images you can choose from.

- 1 During playback, press the **PAGE** + or - button to select a desired page number to be displayed.

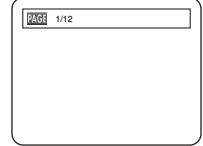

PLAYBACK OF THE BONUS GROUP

Some discs are recorded with the Bonus Group that can be played back by entering a password. Refer to the disc jackets.

- 1 In stop mode, press the **GROUP** button to open the group search screen.
- 2 Press the **Numeric** buttons to select a bonus group number.
 - The password popup window appears.
- 3 Press the **Numeric** buttons to enter the 4-digit password.
 - When the correct password is entered, playback starts from the top of the bonus group.



NOTES:

- In some cases, the password window is displayed on the menu screen. Follow the instructions given on the screen.
- Once the password is entered, playback will be repeated until the disc is removed from the disc tray.

Still / Pause

DVD-V DVD-A CD Super Audio CD MP3 JPEG WMA DivX®

- 1 During playback, press the **STILL/PAUSE** button.
 - Playback will pause and sound will be muted.



- 2 To continue playback, press the **PLAY** button.

NOTE:

- Set STILL MODE to FIELD on the display menu if pictures in the pause mode are blurred (refer to page 28).

Resume

DVD-V DVD-A CD Super Audio CD MP3 JPEG WMA DivX®

- 1 During playback, press the **STOP** button.
 - Resume message will appear on the TV screen.

- 2 Press the **PLAY** button, playback will resume from the point at which playback was stopped.
 - To cancel resume, press the **STOP** button again.

NOTES:

- For MP3, JPEG or WMA, playback will resume from the beginning of the current track.
- The resume information will be saved even when the power is turned off.

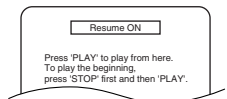

Fast Forward / Reverse Search

DVD-V DVD-A CD Super Audio CD MP3 WMA DivX®

- 1 During playback, press the ◀◀ or ▶▶ button repeatedly to select a desired forward or reverse speed.
 - For DVDs, fast forward or reverse search speed is different depending on the disc. The approximate speed is 1 (x2), 2(x8), 3 (x20), 4 (x50), and 5 (x100).

◀◀ Button

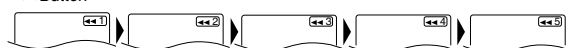

▶▶ Button

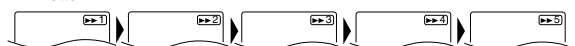

- For Audio CDs, Super Audio CDs, MP3, WMA and DivX®, the approximate speed is 1 (x2), 2 (x8), and 3 (x30).
- For Audio CDs, Super Audio CDs, MP3 and WMA, sound will be output at any speed of fast forward and reverse search.

2 To return to normal playback, press the **PLAY** button.

NOTE:

- For some DivX® files, Fast Forward/Reverse Search may not function.

Slow Forward / Slow Reverse



only Moving picture

1 During playback, press the **STILL/PAUSE** button.

2 Press the **◀◀** or **▶▶** button.

- Slow motion playback will begin and sound will be muted.

3 Press the **◀◀** or **▶▶** button repeatedly to select a desired speed.

- Slow forward or reverse speed is different depending on the disc. The approximate speed is 1 (1/16), 2 (1/8), and 3 (1/2).

4 To return to normal playback, press the **PLAY** button.

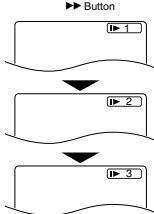

NOTES:

- On DVDs set STILL MODE to FIELD on the display menu if pictures in the slow playback mode are blurred (refer to page 28).
- Only Slow Forward is available when playing back discs with DivX® files.

Step by Step Playback



only Moving picture

1 During playback, press the **STILL/PAUSE** button.

- Playback will pause and sound will be muted.

2 The disc advances frame by frame each time the **STILL/PAUSE** button is pressed.

3 To exit step by step playback, press the **PLAY** button.

NOTE:

- On DVDs, set STILL MODE to FIELD on the display menu if pictures in the pause mode are blurred (refer to page 28).

Zoom



only Moving picture

This function allows you to enlarge the video image and to pan through the zoomed image.

1 Press the **ZOOM** button during playback.

- Playback will continue.

2 Press the **ZOOM** button repeatedly to select a desired zoom factor: x2, x4 or off.

- Only x2 zoom is available on JPEG and DivX®.



3 Use the **Cursor** buttons (**▲**/**▼**/**◀**/**▶**) to move the zoomed picture across the screen.

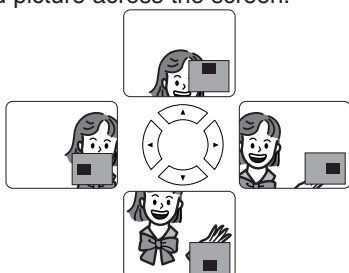

4 To exit zoom mode, press the **ZOOM** button.

NOTES:

- Zoom function does not work while disc menu is shown.
- x4 zoom is not available on some discs.
- Navigation screen is not available on JPEG.
- You cannot pan through the zoomed picture on some JPEG files.

Title / Chapter Search



BY USING THE SEARCH MODE BUTTON

1 Press the **SEARCH MODE** button repeatedly until the chapter search or the title search display appears during playback.

2 Enter the desired chapter/title number with the **Numeric** buttons.



BY USING THE SKIP BUTTONS ◀◀▶▶

During playback, press the **SKIP ▶▶** button to move to the next chapter. Press it repeatedly to skip to subsequent chapters. Press the **SKIP ◀◀** button to go back to the beginning of the current chapter. Press it repeatedly to go to the previous chapters.

- Chapter number will appear briefly on the front panel display during playback DVD. Track number keeps being displayed during playback DivX® video file.
- If the **SKIP ◀◀** or **▶▶** button is pressed while the playback is paused, the playback after skipping to the next chapter will be also paused.

NOTES:

- Depending on the disc being played, the **Numeric** buttons can be used to search for a desired chapter by entering the chapter number directly. Refer to the manual accompanying the disc.
- The **SKIP ◀◀** and **▶▶** buttons are not available when playback is stopped.
- A disc that does not contain chapters within titles, the **SKIP ◀◀** and **▶▶** buttons change the titles.

Track Search



There are two ways to begin playback a disc at a specific track.

BY USING THE SEARCH MODE BUTTON

1 Press the **SEARCH MODE** button.

- The track search display appears.

2 Within 30 seconds, select a

desired track number using the **Numeric** buttons.

- For the disc with less than 10 tracks, press the track number directly.

- For discs with 10 or more but less than 100 tracks, to play back a single-digit track, press **0** first, then the track number (e.g. for track 3, press **0, 3**). To play back a double-digit track, press the track number.

- For discs with 100 or more tracks, to play back a single- or a double-digit track, press **0** first, then the track number (e.g. for track 3, press **0, 0, 3**, and for track 26, press **0, 2, 6**). To play back a triple-digit track, press the track number.

- Press the **CLEAR** button to erase the incorrect input.

NOTE:

- The **+10** button can also bring up the track search display except for the disc with less than 10 tracks. For such a disc, track search can be done by just pressing the track number.

BY USING THE SKIP BUTTONS ◀◀▶▶

During playback, press the **SKIP ▶▶** button to move to the next track. Press it repeatedly to skip to subsequent tracks. Press the **SKIP ◀◀** button to go back to the beginning of the current track. Press it repeatedly to go to the previous tracks.

- Track number will appear briefly on the front panel display.
- If the **SKIP ◀◀** or **▶▶** button is pressed while the playback is paused, the playback will be paused again after skipping to the next track.

DISC PLAYBACK

NOTES:

- The **SKIP** ◀◀ and ▶▶ buttons are not available when playback is stopped.
- When the **SKIP** ◀◀, ▶▶ button is pressed during playback DivX® video file, and if it does not change previous/next track, press the **MENU** button.

Time Search

DVD-V DVD-A CD Super Audio CD DivX®

- Press the **SEARCH MODE** button until the time search screen appears on the TV screen.
- Within 30 seconds, enter a desired disc time point on the disc with the **Numeric** buttons.

- Playback will start at the specified time.
- For Time Search, "0" appears automatically when there is no need to enter a number. For example, "0:0_ _" appears in the time search screen if the total time of the disc is less than 10 minutes.

- Press the **CLEAR** button to erase an incorrect input.

NOTE:

- For some DivX® files, Time Search may not function.

Marker Setup Screen

DVD-V DVD-A CD Super Audio CD

You can use markers to memorize your favorite places on a disc.

- Press the **SEARCH MODE** button repeatedly until the display screen and Markers appear during playback.
- Press the **Cursor** buttons (◀ or ▶) to select the number of the marker (1-10) and ensure that "_ : _ _ : _ _" appears in the display.
- When the disc reaches the point you want to remember, press the **ENTER** button.
 - The title or track and elapsed playback time will appear in the TV screen.
- To return to the Marker later, press the **SEARCH MODE** button repeatedly during playback and the **Cursor** buttons (◀ or ▶) button to choose a desired marker, then press the **ENTER** button.
- Press the **SEARCH MODE** or **RETURN** button to exit.

NOTES:

- Opening the disc tray, turning off the power or selecting AC at step 2 and pressing the **ENTER** button will erase all Markers.
- To clear a marker, using the **Cursor** buttons (◀ or ▶), position the cursor on to the marker number to be cleared and press the **CLEAR** button.
- You can mark up to 10 points.

Repeat

- The **REPEAT** button is available only during playback.

REPEAT TITLE / CHAPTER

DVD-V DivX®

To activate Repeat function, press the **REPEAT** button during playback.

- The repeat mode changes as described below every time you press the button.

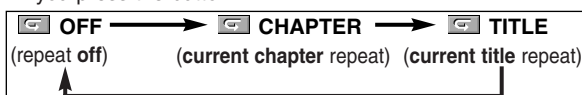

NOTES:

- The Repeat Title/Chapter setting will be cleared when moving to other title or chapter.
- Repeat playback does not function during A-B repeat playback.
- Repeat Title/Chapter is not available with some scenes.

REPEAT TRACK / GROUP / ALL

CD Super Audio CD

To activate Repeat function, press the **REPEAT** button during playback.

- The repeat mode changes as described below every time you press the button.



NOTES:

- In the track repeat, the repeat setting will be cleared when moving to other track.
- Repeat playback does not function during A-B repeat playback.

DVD-A MP3 JPEG WMA DivX®

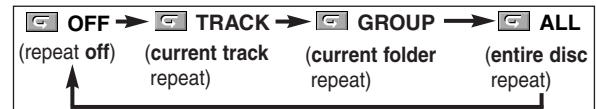

NOTES:

- In the track or group repeat, the repeat setting will be cleared when moving to other track or group.
- When the DivX® media file change to DivX® video file while the repeat setting is done, the repeat setting will be cleared.
- For DVD-Audio, ALL repeat is effective only when all groups are being played back.

A-B REPEAT

DVD-V DVD-A CD Super Audio CD DivX®

- Press the **A-B REPEAT** button at your chosen starting point.
 - A- appears briefly on the TV screen.
- Press the **A-B REPEAT** button again at your chosen end point.
 - A-B appears briefly on the TV screen, and the repeat sequence begins.
- To exit the sequence, press the **A-B REPEAT** button.

NOTES:

- The A-B Repeat section can only be set within the current title (for DVDs or DivX® Video files), or current track (for DVD-Audio, Audio CD, Super Audio CD and disc with DivX® media files.).
- A-B Repeat is not available with some scenes on DVD.
- To cancel the A point which was set, press the **CLEAR** button.
- A-B Repeat playback does not function during title, chapter, track, group or all repeat playback.
- For some DivX® files, A-B Repeat playback may not function.

Program Playback

This function allows you to program a playback order of DVD-Audio, Audio CD, Super Audio CD, MP3, JPEG, or WMA in a desired sequence.

DVD-A

- 1 In stop mode, press the **MODE** button repeatedly until the program screen appears.
 - The group selection screen will appear.
- 2 Press the **Cursor** buttons (▲ or ▼) to select a group, then press the **ENTER** button.
 - The track selection screen will be displayed.
 - It takes approximately five seconds until the track selection screen appears.
- 3 Press the **Cursor** buttons (▲ or ▼) to select a track, then press the **ENTER** button.
 - Press the **CLEAR** button to erase the most recently entered track.
 - Press the **Cursor** button (◀) button to go back to the group selection screen from the track selection screen.
- 4 Press the **PLAY** button to play back the programmed tracks.

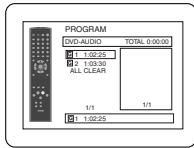

CD Super Audio CD

- 1 In stop mode, press the **MODE** button.
 - The program screen will appear.
- 2 Press the **Cursor** buttons (▲ or ▼) to select a track, then press the **ENTER** button.
 - Press the **CLEAR** button to erase the most recently entered track.
- 3 Press the **PLAY** button to start programmed playback.

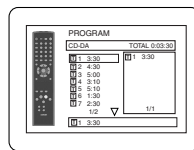

<Example: CD>

MP3 JPEG WMA

- 1 In stop mode, press the **MODE** button.
 - The program screen will appear.
- 2 Press the **Cursor** buttons (▲ or ▼) to select a group, then press the **ENTER** button.
 - A track selection screen appears.
- 3 Press the **Cursor** buttons (▲ or ▼) to select a track, then press the **ENTER** button to save it in a program.
 - Press the **CLEAR** button to erase the most recently entered track.
 - The programmed track is displayed in the right-hand screen.
 - If the entire program cannot be displayed on the screen, “▼” appears.
 - Pressing the **Cursor** button (◀) will show a list of folders that belong to the hierarchy which is one-level higher than the currently selected folder.
- 4 Press the **PLAY** button to start programmed playback.
 - Press the **RETURN** button, and the stop screen will show up with the program contents in memory.

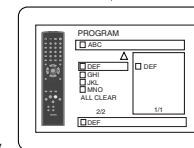
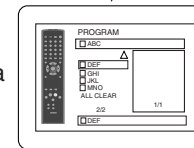
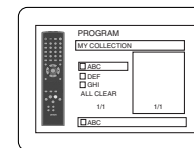

NOTES:

- Press the **STOP** button once and then the **PLAY** button again, playback will restart from the point where the **STOP** button was pressed. (Program continued.)
- Press the **STOP** button twice and then the **PLAY** button again, playback will restart from the first track in the usual way. Your program is still stored until either the disc tray is open or power is turned off.
- Up to 99 tracks can be entered.
- To erase tracks in the program all together, select **ALL CLEAR** at the bottom of the list at step 2. And, “A-CLEAR” is displayed on the front panel display at that time.
- To repeat the current track in the program, press the **REPEAT** button repeatedly until [G] TRACK appears during playback. To repeat the entire program press the **REPEAT** button repeatedly until [G] ALL appears during playback.
- If eight or more tracks were set in a program, use the **SKIP** (◀◀ or ▶▶) button to see all the tracks.
- When selecting the folder:
 - Press the **Cursor** button (▶) when you want to go to the next hierarchy.
 - Press the **Cursor** button (◀) when you want to go back to the previous hierarchy (except for the top hierarchy).
- Even if an inserted disc contains mixed MP3, JPEG and WMA files, Program function allows 99 tracks in combination of MP3, JPEG and WMA files.
- The front panel display has blinked while setting the program playback.
- “F-***” is displayed in the front panel display while selecting the group (folder). (*** is group (folder) number.)

Random Playback

This function shuffles the playback order of tracks instead of playback in the original sequence.

DVD-A

- 1 In stop mode, press the **RANDOM** button.
 - The random screen will appear.
- 2 Press the **Cursor** buttons (▲ or ▼) to select a desired group to play back randomly, then press the **ENTER** or **PLAY** button.
 - Random playback will start.

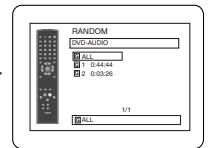

CD Super Audio CD MP3 JPEG WMA

- 1 In stop mode, press the **RANDOM** button.
 - The random screen will appear.
- 2 Press the **PLAY** button to start random playback.

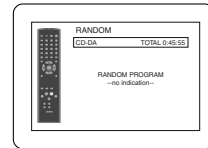

<Example: CD>

NOTES:

- To repeat the current track in the random selection, press the **REPEAT** button repeatedly until [G] TRACK appears during playback. To repeat the entire random selection press the **REPEAT** button repeatedly until [G] ALL appears during playback.
- You cannot go back to the previous track during random playback.
- For a disc containing mixed MP3, JPEG and WMA files, random playback of those files will be performed.
- “SHUFFLE” is displayed on the front panel display at step 1.

MP3 / JPEG / WMA Playback





MP3 **JPEG** **WMA**

When a DVD-R/RW or CD-R/RW disc with MP3, JPEG or WMA files is inserted in the DVD player, the file list will appear on display. The number of tracks is also displayed on the front panel.

- Press the **Cursor** buttons (▲ or ▼) to select the desired group (folder) or track.
 - To return to the previous screen, press the **Cursor** button (◀).
 - If a group (folder) is selected, press the **Cursor** button (▶) or **ENTER** button to go on to the track selection screen. Press the **Cursor** buttons (▲ or ▼) to choose a track, then press the **PLAY** or **ENTER** button.
 - If a track is selected, press the **PLAY** or **ENTER** button to start playing back tracks. The selected track and the subsequent tracks will be played back.
 - When selecting the folders
 - Press the **Cursor** button (▶) when you want to go to the next hierarchy.
 - Press the **Cursor** button (◀) when you want to go back to the previous hierarchy (except for the top hierarchy).
- Press the **TOP MENU** button to return to the first item.

2 Press the **STOP** button to stop playback.

NOTES:

- Folders are known as Groups; files are known as Tracks.
- A symbol of  is shown on the top of the group name.
- A symbol of  is shown on the top of MP3 files.
- A symbol of  is shown on the top of JPEG files.
- A symbol of  is shown on the top of WMA files.
- Maximum of 255 folders can be recognized.
- Maximum of 999 files can be recognized.
- Up to 8 hierarchies can be recognized.
- If the track extends beyond the scope of screen, a down arrow "▼" appears, indicating that the user can view another part on the previous page. The current page number and the number of total pages are shown on the left of the down arrow "▼".
- If no MP3, JPEG or WMA files are found in the group, the group is not displayed.
- The DVD player can reproduce data recorded as per ISO 9660 Level 1, Level 2 or Joliet on the disc.
- It can also run a disc on which data is recorded in a multi-session.
- For more details of recording systems, refer to the instruction manual for the DVD-R/RW / CD-R/RW drive or the writing software.
- For MP3 and WMA files recorded in Variable Bit Rate (VBR), the unit may not display the actual elapsed time.

This player recommends the use of files recorded at the following specifications:

Applicable MP3 file		Remarks
Sampling frequency	44.1kHz 48kHz	• It is prohibited to record MP3 sound on a digital device when the connection is made digitally.
Type	MPEG1 audio layer 3	• MP3 files recorded at fixed bit rate of 32 kbps or higher are recommended.

Applicable JPEG file		Remarks
Size of image	Upper limit: 6300x5100 dots Lower limit: 32x32 dots	• A JPEG image that extends beyond the screen is reduced so that it will be displayed within the screen.

Applicable WMA file		Remarks
Sampling frequency	44.1kHz 48kHz	• Those frequencies are applicable to WMA version 9.
Bit rate	48–192kbps	• Ensure that the copyright function is set to off when preparing a WMA disc.
Type	WMA version 9	• A prohibition "disable" symbol will appear if the user attempts to run a non-reproducible file such as copyright-protected. • Recorded in Multi-channel format cannot be played back.

Information on MP3, JPEG and WMA discs

- This DVD player can play back images and sounds from data recorded in MP3 and JPEG formats on DVD-R/RW or CD-R/RW discs.
- A file with an extension of ".mp3 (MP3)" is called an MP3 file.
- A file with an extension of ".jpg (JPG)" or ".jpeg (JPEG)" is called a JPEG file.
 - The DVD player can run an image file conforming to the Exif specification. Exif is a file format, Exchangeable Image File format established by Japanese Electronic Industry Development Association (JEIDA).
- A file with an extension of ".wma (WMA)" is called a WMA file.
- Files whose extension is other than ".mp3 (MP3)", ".jpg (JPG)" and ".jpeg (JPEG)" or ".wma (WMA)" will not be listed on the MP3, JPEG or WMA menu.
- If the file is not recorded in MP3, JPEG or WMA format, noise may be produced even if the file extension is either ".mp3 (MP3)", ".jpg (JPG)", ".jpeg (JPEG)" or ".wma (WMA)".
- The name of group and track can be displayed up to 25 characters. Unrecognizable characters will be replaced with asterisks. The ninth and deeper hierarchies cannot be displayed.
- Unplayable groups or tracks may be displayed depending on the recording conditions.
- If the **TOP MENU** button is pressed when a file list is displayed, the first item will be highlighted.

Kodak Picture CD

The DVD player can also run JPEG files stored on Kodak Picture CDs. You can enjoy picture images on the television set by playing back the Picture CDs.

This unit conforms to ver. 7.0 of Kodak Picture CD.

For details of Kodak Picture CD, contact a shop that provide developing service of Kodak Inc.

- When Kodak Picture CD is inserted in the DVD player, Kodak Picture CD menu appear automatically on the TV screen.
 - If all menu items cannot be displayed on the screen scope, "▶▶" appears at the right bottom of the screen, indicating that the user can view remaining items on the next page. "◀◀" appears, it indicates that the user can view other items on the previous page. The track number of the currently highlighted item and the total tracks are shown at the center bottom of the screen.
 - If "▶▶" is shown at the right bottom, use the **SKIP ▶▶** button to view the next page. If "◀◀" is shown at the left bottom, use the **SKIP ◀◀** button to view the previous page.
 - It may take some time until all menu items are displayed on the menu screen.

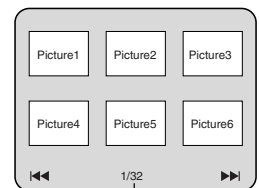

Current track number / the number of total tracks

2 Press the **Cursor** buttons (▲ / ▼ / ◀ / ▶), select a desired track to be played back, then press the **PLAY** or **ENTER** button.

- If a Kodak Picture CD file is selected, an image will be played back from the selected track and go to the next one in turn.

3 Press the **STOP** button to stop playback.

NOTES on JPEG and Kodak Picture CD:

- A track is displayed for 5 or 10 seconds and then the next track is displayed.
- Every press on the **ANGLE** button will turn the image clockwise by 90 degrees when an image is displayed.
- To change the size of the playback image, press the **MODE** button twice. The size change mode appears on top of the TV screen during playback. Then press the **Cursor** buttons (◀ or ▶) or **ENTER** button to switch between **NORMAL** (100%) and **SMALL** (95%).
- Progressive JPEGs (JPEG files saved in the progressive format) will not be played back on this DVD player.
- High resolution JPEG files take longer to be displayed.

- The size change mode may have no effect on some files (e.g. files with a small picture size).
- In stop mode, press the **MENU** button. Kodak Picture CD menu appears.

NOTES on WMA:

- The DVD player can reproduce data recorded as ISO 9660 level 2 with 31 characters file name included punctuation marks. The name of file can be displayed up to 25 characters.
- Maximum of 8 subfolders can be recognized.
- It can also be displayed tag information of WMA at least 64 characters.
- A file with an extension of Joliet as Unicode format in up to 64 characters can be recognized.
- This unit cannot play back copyright protected WMA files.

DivX® Playback



This DVD player can play back DVD-R/RW and CD-R/RW discs recorded in DivX® format. When a DVD-R/RW or CD-R/RW with DivX® files is inserted in the DVD player, the file list will appear automatically on the TV screen. The number of tracks will be also displayed on the front panel.

- 1 Press the **Cursor** buttons (▲ or ▼) to select the desired group (folder) or track.
 - To return to the previous screen, press the **Cursor** button (◀).
 - If a group (folder) is selected, press the **Cursor** button (▶) or **ENTER** button to go on to the track selection screen. Press the **Cursor** buttons (▲ or ▼) to choose a track, then press the **PLAY** or **ENTER** button.
 - If a track is selected, press the **PLAY** or **ENTER** button to start playing back tracks. The selected track and the subsequent tracks will be played back.
 - When selecting the folders
 - Press the **Cursor** button (▶) when you want to go to the next hierarchy.
 - Press the **Cursor** button (◀) when you want to go back to the previous hierarchy (except for the top hierarchy).
- 2 Press the **TOP MENU** button to return to the first item.

NOTES:

- DivX® is a codec (compression / decompression) that can compress images to a very small amount of data. The software can compress video data from almost any sources to the size that can be sent on the Internet without compromising visual quality of the images.
- A file with an extension of “.avi” or “.divx” is called a DivX® file. All files with the “.avi” extension are recognized as MPEG 4.
- Files with extension other than “.avi” and “.divx” will not be listed on the DivX® menu. However, unplayable groups or tracks may be displayed, depending on the recording conditions.
- Even if the file has an extension of either “.avi” or “.divx”, this player cannot play it back if it is recorded in the format other than DivX®.
- Folders are known as Groups; files are known as tracks.
- A symbol of  is shown on the top of DivX® file.
- Maximum of 255 folders can be recognized.
- Maximum of 999 files can be recognized.
- If the track extends beyond the scope of screen, a down arrow “▼” appears, indicating that the user can view another part on the previous page. The current page number and the number of total pages are shown on the left of the down arrow “▼”.
- The name of group and track can be displayed up to 25 characters. Unrecognizable characters will be replaced with asterisks. The ninth and deeper hierarchies cannot be displayed.
- You can play back the disc recorded in multi-session.
- Playback will be paused if the file list is displayed during the playback.
- It may take a while for audio and images to be output after you inserted a disc and pressed the **PLAY** button.
- When playing back the files recorded in high bit rates, the images can be interrupted on some occasions.

- Although DivX® logo has been obtained for this player, it may not be able to play back some data, depending on the disc characteristics, bit rates, or audio format settings, etc.
- Use the software recognized by DivX®, Inc. when you make DivX® files.
- When using tools or utilities to make up DivX® files, read their instruction manual beforehand.
- A DivX® file whose file size exceeds 2GB cannot be played back.
- If a large-sized DivX® file is selected, it may take a while to start the playback (over 20 seconds sometimes).
- Constant bit rate of image between 500 kbps and 4,000 kbps is recommended if you make DivX® files on a CD-R/RW.
- If DivX® files written on CD discs cannot be played back, rewrite them on a DVD disc and try to play back.
- For more information for DivX®, please visit: <http://www.divx.com>
- If you insert a DVD-R/RW or CD-R/RW with DivX® files that are mixed with MP3, JPEG, or WMA files, the Playback Media Selection screen will be displayed. Please select Video and proceed to step 1.



- Press the **TOP MENU** button to call up the Playback Media Selection screen in stop mode.
- If you select Audio & Pictures, instead of Video on the Playback Media Selection screen, the DVD player can play back MP3/JPEG/WMA files. Refer to page 22 for details.

This player recommends the use of files recorded at the following specifications:

Applicable DivX® file		Remarks
Playable Codec of AVI files	Plays all versions of DivX® video (including DivX® 6) with standard playback of DivX® media files.	• They are recognized as MPEG 4.
Maximum size of image	720 x 480 @30fps 720 x 576 @25fps	
Sampling frequency of audio	8kHz - 48kHz	• It is prohibited to record MP3 sound on a digital device when the connection is made digitally.
Audio type	MPEG1 audio layer 3 (MP3) MPEG1 audio layer 2 Dolby Digital	• MP3 files recorded at fixed bit rate of 32kbps or higher are recommended.

DivX® Subtitle

DivX®

The subtitle created by the user can be displayed during DivX® media file playback.

- After select the DivX® media file, the SUBTITLE LIST will appear except when the "DivX SUBTITLE" setting is "OFF". Refer to "Language Setting" on page 28.

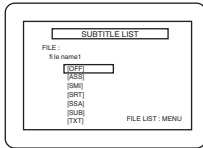

- Press the **Cursor** buttons (▲ or ▼) to select the desired extension you want to display, then press the **ENTER** button. DivX® media file with the subtitle starts playback. The subtitle cannot be displayed when the setting is "OFF".
 - If there is more than one extension, the extension selection appears in the SUBTITLE LIST.

NOTES:

- DivX® subtitle can only be displayed according to the same name with an extension of the DivX® file name.
- Files whose extension is other than ".ASS", ".ass", ".SMI", ".smi", ".SRT", ".srt", ".SSA", ".ssa", ".SUB", ".sub", ".TXT" and ".txt" will not be listed in the SUBTITLE LIST.
- This unit cannot be recognized if the DivX® media file and its subtitle file are not in the one folder.
- The subtitle may not be displayed if the file size is too large.
- To change the subtitle, refer to "Subtitle Language" on page 26 if multiple subtitles are available.
- The subtitle cannot display if the on-screen information is displayed.
- If "DivX SUBTITLE" is set to "OFF" in LANGUAGE menu, the SUBTITLE LIST will not be displayed even if you select a DivX® media file with created subtitle.
- Unrecognizable characters will be replaced with asterisks.
- DivX® subtitle function is invalid to DivX® video file.
- Some files whose extension is ".SUB", ".sub", ".TXT" and ".txt" may not be displayed.

Changing the On-Screen Display

You can check information about the current disc by pressing the **DISPLAY** button on the remote control.

DVD-V

- Press the **DISPLAY** button during playback.
 - Current chapter number/total chapters, elapsed time and remaining time of the current chapter, and current playback status will be displayed.
- Press the **DISPLAY** button again.
 - Current title number/total titles, elapsed time and remaining time of the current title, and current playback status will be displayed.
- Press the **DISPLAY** button again.
 - The bit rate (the amount of video data currently being read) and current playback status will be displayed.
 - Current repeat setting appears on the right side of the display bar only when the repeat setting is active. (◁ C: Chapter repeat/ ▷ T: Title repeat/ A ◁ B: A-B repeat)
 - If you are playing back a two-layered disc, the layer number will also be displayed. (L0: Layer 0 is played back. L1: Layer 1 is played back.)
- Press the **DISPLAY** button again.
 - Current HDMI status will be displayed during the HDMI output mode. (Refer to NOTE FOR HDMI DISPLAY on page 25.)
- Press the **DISPLAY** button again to exit.

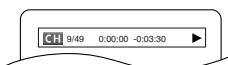

DVD-A

- Press the **DISPLAY** button during playback.
 - Current track number/total tracks, elapsed time and remaining time of the current track, and current playback status will be displayed.
- Press the **DISPLAY** button again.
 - Current group number/total groups, elapsed time and remaining time of the current group, and current playback status will be displayed.
- Press the **DISPLAY** button again.
 - The bit rate and current playback status will be displayed.
 - Current repeat setting appears on the right side of the display bar only when the repeat setting is active. (◁ T: Track repeat/ ▷ G: Group repeat/ A ◁ B: A-B repeat)
 - If you are playing back a two-layered disc, the layer number will also be displayed. (L0: Layer 0 is being played back. L1: Layer 1 is being played back.)
- Press the **DISPLAY** button again.
 - During all group, program or random playback, each playback status will be displayed when you press the **DISPLAY** button. Then press the **DISPLAY** button again.
 - Current HDMI status will be displayed during the HDMI output mode. (Refer to NOTE FOR HDMI DISPLAY on page 25.)
- Press the **DISPLAY** button again to exit.



- Press the **DISPLAY** button during playback.
 - Current track number/total tracks, elapsed time and remaining time of the current track, and current playback status will be displayed.
 - Current repeat setting appears on the right side of the display bar only when the Repeat setting is active. (◁ T: Track repeat/ ▷ A: All tracks repeat/ A ◁ B: A-B repeat)
- Press the **DISPLAY** button again.
 - Current track number/total tracks, elapsed time and remaining time of the entire disc, and current playback status will be displayed.
 - Current repeat setting appears on the right side of the display bar only when the Repeat setting is active. (◁ T: Track repeat/ ▷ A: All tracks repeat/ A ◁ B: A-B repeat)
 - When you are playing back a disc in program or random mode, PROGRAM (or RANDOM) will be displayed.
- Press the **DISPLAY** button again.
 - During program or random playback, each playback status will be displayed when you press the **DISPLAY** button. Then press the **DISPLAY** button again.
 - Current HDMI status will be displayed during the HDMI output mode. (Refer to NOTE FOR HDMI DISPLAY on page 25.)
- Press the **DISPLAY** button again to exit.

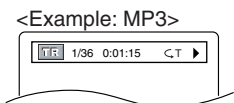
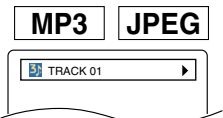

- Press the **DISPLAY** button during playback.
 - Current file name will be displayed.
- Press the **DISPLAY** button again.
 - Current track number/total tracks and elapsed time (MP3) will be displayed.
 - Current repeat setting appears only when the Repeat setting is active. (◁ T: Track repeat/ ▷ A: All (disc) repeat/ ▷ G: Group repeat)
 - When you are playing back a disc with MP3 or JPEG files in program or random mode, PROGRAM (or RANDOM) will be displayed.
- Press the **DISPLAY** button again.
 - During program or random playback, each playback status will be displayed when you press the **DISPLAY** button. Then press the **DISPLAY** button again.
 - Current HDMI status will be displayed during the HDMI output mode. (Refer to NOTE FOR HDMI DISPLAY on page 25.)
- Press the **DISPLAY** button again to exit.

WMA

- 1** Press the **DISPLAY** button during playback.
 - Current file name will be displayed.
- 2** Press the **DISPLAY** button again.
 - Title name based on tag information of currently played-back file will be displayed.
- 3** Press the **DISPLAY** button again.
 - Artist name based on tag information of currently played-back file will be displayed.
- 4** Press the **DISPLAY** button again.
 - Current track number/total tracks and elapsed time will be displayed.
 - Current repeat setting appears only when the Repeat setting is active.
(◀ T: Track repeat/ ◀ A: All (disc) repeat/ ◀ G: Group (folder) repeat).
 - When you are playing back a disc in program or random mode, **PROGRAM** (or **RANDOM**) will be displayed.
- 5** Press the **DISPLAY** button again.
 - During program or random playback, each playback status will be displayed when you press the **DISPLAY** button. Then press the **DISPLAY** button again.
 - Current HDMI status will be displayed during the HDMI output mode. (Refer to NOTE FOR HDMI DISPLAY on this page.)

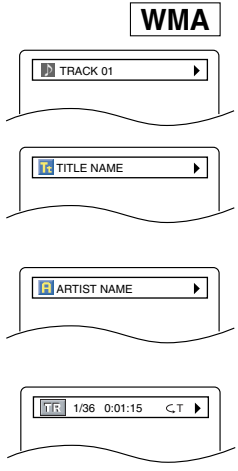

6 Press the **DISPLAY** button again to exit.

NOTE FOR HDMI DISPLAY:

- The displayed HDMI status are as follows:
 1. Information for image output/Resolution of image
 2. Sound output format
 3. Maximum number of audio channels that can be accepted by the connected equipment



Slide Show Mode

You can switch to the slide show mode during playback.

- 1** Press the **MODE** button during playback.
 - The slide show mode screen will appear.
 - You cannot change to the slide show mode in stop mode or from the file list screen or the Picture CD menu screen.
- 2** Press the **ENTER** button.
 - The slide show mode will change.
 - CUT IN/OUT: The entire image appears in one time.
 - FADE IN/OUT: The image appears and disappears gradually.
- 3** Press the **MODE** button to exit.

JPEG

Dialog Speed



Available only on discs recorded in the Dolby Digital format, Dialog Speed plays back in slightly faster or slower speed while keeping the sound quality as in the normal playback.

- 1** During playback, press the **MODE** button repeatedly until the Dialog Speed setting appears.
 - OFF appears on the TV screen.
- 2** Press the **ENTER** button or the **Cursor** buttons (◀ ▶) to switch among ♪ (x1.3), ♫ (x0.8) and OFF.
 - ♪ : Plays back approximately at 0.8 times of normal playback.
 - ♪♪ : Plays back approximately at 1.3 times of normal playback.
- 3** To return to normal playback, press the **PLAY** button.

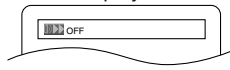

NOTES:

- Every time you press the **STOP** button, the setting will be turned OFF.
- Subtitle can be viewed during this function.
- Picture Control, Black Level, Audio Language and Virtual Surround setting cannot be changed while using this mode.
- Virtual Surround does not function while using this mode.
- This feature may not work at some point on a disc.
- When using digital audio connection (COAXIAL, OPTICAL or HDMI), the LPCM sound will be output.
- When using the Dialog Speed function with Multi-channel digital outputting, the analog output sound will be fixed at 2 channel.
- When using digital audio connection, only the Dolby Digital sound will be available.
- This feature does not work when the video format of the inserted disc does not match to the output video format setting of this unit (playing NTSC disc while TV TYPE is set to PAL etc.).

DivX®

- 1** Press the **DISPLAY** button.
 - Current file name will be displayed.
- 2** Press the **DISPLAY** button.
 - Current track number/total tracks and elapsed time will be displayed.
 - During playback DivX® video file, ":-:--:--" is displayed at elapsed/remain time.
 - Current repeat setting appears only when the Repeat setting is active.
DivX® media file: (◀ T: Track repeat / ◀ A: All(disc) repeat/ ◀ G: Group repeat / A ◀ B: A-B repeat)
DivX® video file: (◀ T: Title repeat / ◀ C: Chapter repeat / A ◀ B: A-B repeat)
- 3** Press the **DISPLAY** button.
 - Current chapter number/total Chapters, elapsed time and remaining time of the current chapter, and current playback status will be displayed.
 - During playback DivX® video file only, this On-screen is displayed.
- 4** Press the **DISPLAY** button.
 - Current title number/total titles, elapsed time and remaining time of the current title, and current playback status will be displayed.
 - During playback DivX® video file only, this On-screen is displayed.
- 5** Press the **DISPLAY** button again.
 - Current HDMI status will be displayed during the HDMI output mode. (Refer to NOTE FOR HDMI DISPLAY on this page)

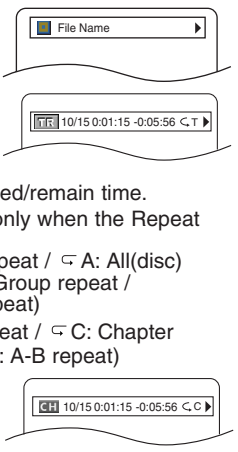

Audio Language

DVD-V **DivX®**

The DVD player allows you to select a language (if multiple languages are available) during DVD or DivX® disc playback.

- 1 Press the **AUDIO** button during playback.
- 2 Press the **AUDIO** button repeatedly to select your desired language.

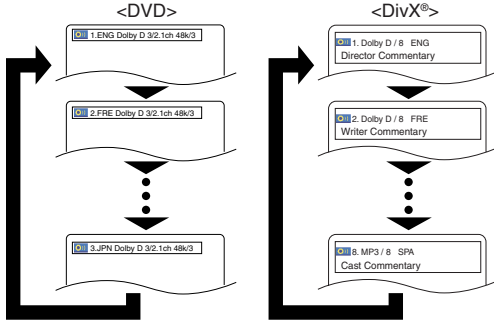

• For DivX® several audio tag information exists. Some examples are shown as follows.

<Example>

Director Commentary: Audio recorded comment of the movie director.

Writer Commentary: Audio recorded comment of the movie writer.

Cast Commentary: Audio recorded comment of the movie actors.

etc.

NOTES:

- The sound mode cannot be changed during playback of discs not recorded in double sound.
- Some discs allow to change audio language setting on the disc menu. (Operation varies between discs. Refer to the manual accompanying the disc.)
- Pressing the **AUDIO** button may not work on some DVDs with multiple audio languages (e.g. DVDs which allow to change audio language setting on the disc menu).
- If you choose a language that has a three-letter language code, the code will be displayed every time you change the Audio Language setting. If you choose any other Languages, '---' will be displayed instead (refer to page 32).
- Audio Language selection cannot be made during Dialog Speed in DVD (refer to page 25).
- If the disc has no audio language, NOT AVAILABLE will be displayed.
- If the DivX® file has no audio tag information, the audio tag is not displayed.

Subtitle Language

DVD-V **DivX®**

The DVD player allows you to select a subtitle language (if multiple languages are available) during DVD or DivX® disc playback.

- 1 Press the **SUBTITLE** button during playback.
- 2 Press the **SUBTITLE** button repeatedly to select your desired subtitle language.
 - The selected language will be displayed on the display bar at the top of the screen.
 - Press the **Cursor** buttons (◀ or ▶) to turn on or off subtitles during playback.

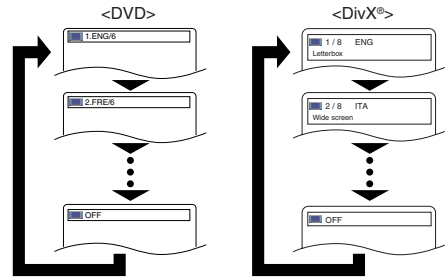

• For DivX® several subtitle tag information exists. Some examples are shown as follows.

<Example>

Letterbox: Subtitle for the letterbox version of the movie.

Wide screen: Subtitle for the widescreen version of the movie.

Children: Subtitle for an audience of children. etc.

- 3 To turn off subtitles, press the **SUBTITLE** button repeatedly until OFF appears.

NOTES:

- Some discs allow subtitle language setting on the disc menu. (Operation varies between discs. Refer to the manual accompanying the disc.)
- Pressing the **SUBTITLE** button may not work on some DVDs with multiple subtitle languages (e.g. DVDs which allow subtitle language setting on the disc menu).
- If your desired language is not shown after pressing the **SUBTITLE** button several times, the disc does not have subtitles in that language.
- If you choose a language that has a three-letter language code, the code will be displayed every time you change the Subtitle Language setting. If you choose any other Languages, '---' will be displayed instead (refer to page 32).
- If the disc has no subtitle language, NOT AVAILABLE will be displayed.
- For discs with DivX® files, the screen only displays the number of subtitle languages.
- If the DivX® file has no subtitle tag information, the subtitle tag is not displayed.

Camera Angle

DVD-V

Some DVD discs contain scenes which have been shot simultaneously from various angles. You can change the camera angle when the (📷) mark appears on the screen.

- 1 Press the **ANGLE** button during playback.
 - The selected angle will be displayed on the display bar at the top of the screen.
- 2 Press the **ANGLE** button repeatedly to select your desired angle.

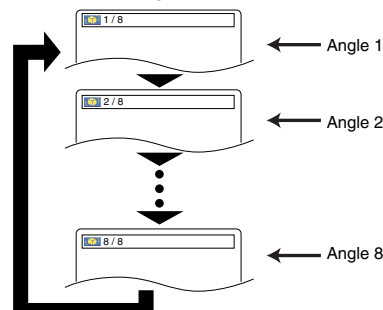

NOTE:

- If the **ANGLE ICON** setting is OFF in the others menu, the (📷) will not appear (refer to page 31).

Picture Control

DVD-V DVD-A DivX®

Picture Control adjusts Brightness, Contrast, Color, Gamma Correction and Sharpness of the specific display.

- 1 During playback, press the **MODE** button.
- 2 Press the **Cursor** buttons (▲ or ▼) to switch among items.
- 3 Press the **ENTER** button or the **Cursor** buttons (◀ or ▶) to adjust the selected item to a desired level.
 - -6, -5, -4, -3, -2, -1, 0, +1, +2, +3, +4, +5, +6 can be selected.
- 4 To return to normal playback, press the **RETURN** button.



NOTES:

- The default settings for all items in Picture Control are "0".
- The setting display will disappear in 10 seconds of no use.
- This function cannot be used during Dialog Speed (refer to page 25).
- If you return all items to the default settings, select "INITIALIZE" at step 2.

Sound Mode

DVD-A

This function allows you to select a desired sound mode during DVD-Audio playback.

- 1 Press the **AUDIO** button during playback.
- 2 Press the **AUDIO** button repeatedly to select your desired sound.

NOTE:

- When selecting a multi-channel sound, it may not mixed down in some cases even though the HDMI AUDIO or ANALOG AUDIO is 2 CHANNEL.

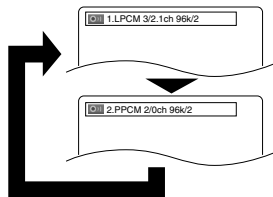

Stereo Sound Mode

CD

- 1 Press the **AUDIO** button repeatedly during playback to select your desired sound mode.

STEREO - both right and left channels are active (stereo)
 L-ch - only left channel is active
 R-ch - only right channel is active

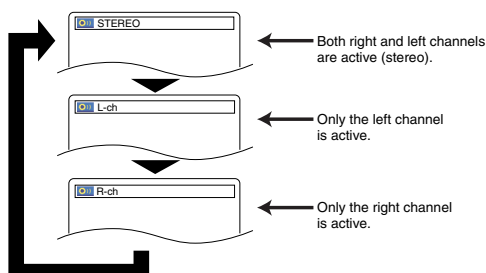

NOTE:

- Stereo sound mode will not be changed when playing DTS CD.

Super Audio CD Setup

Super Audio CD

- 1 Press the **SUPER AUDIO CD SET UP** button repeatedly to select among MULTI-CH AREA, CD AREA, or 2CH AREA.

MULTI-CH AREA - Playback in multi channel format. The number of channels depends on the disc being played.
 CD AREA - Playback in the same quality with sound as normal CDs.
 2CH AREA - Playback in higher quality than that of normal CD sound.

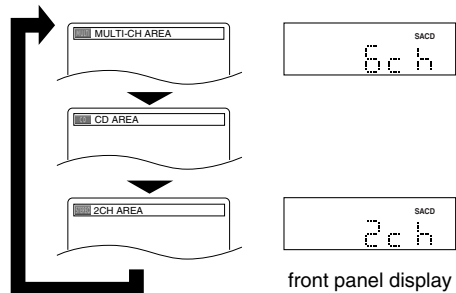

NOTES:

- The Virtual Surround setting is not available for Super Audio CDs. (It may be possible to use the Virtual Surround setting when playing back discs that include a CD area.)
- Some playback options may not be available. These will be skipped.
- MULTI-CH AREA is selected as default.

Virtual Surround

DVD-V DVD-A CD MP3 WMA

You can enjoy stereo phonic virtual space through your existing 2 channel stereo system.

- 1 During playback, press the **MODE** button repeatedly until the Virtual Surround setting appears.



- 2 Press the **ENTER** button to set it 1(Natural effect), 2(Emphasized effect) or OFF.

- 3 Press the **RETURN** button to exit.

NOTES:

- Select Virtual Surround OFF or lower the volume if the sound is distorted.
- Virtual Surround will not be effective if the sound mode is set to something other than STEREO (for Audio CD playback only).
- This function cannot be used during Dialog Speed (refer to page 25).
- Set HDMI AUDIO and ANALOG AUDIO to 2 CHANNEL to use this function (refer to pages 29-30).
- The Virtual Surround setting is not available for Super Audio CDs. (It may be possible to use the Virtual Surround setting when playing back discs that include a CD area.)

Black Level Setting

DVD-V DVD-A DivX®

Adjust the Black Level Setting to make the black parts of the picture as bright as you prefer.

- 1 During playback, press the **MODE** button repeatedly until Black Level setting appears.

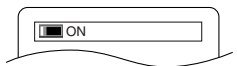

- 2 Press the **ENTER** button to switch ON/OFF.
 ON (Default) : Makes the dark parts brighter.
 OFF : Shows the original picture as recorded.

- 3 Press the **RETURN** button to exit.

NOTE:

- This function cannot be used during Dialog Speed (refer to page 25).

DVD SETUP

In Setup menu, QUICK mode, CUSTOM mode and INITIALIZE mode are available (refer to pages 28-32). QUICK mode consists of the setting menus frequently used, and they are accompanied with **QUICK** mark. You can make all settings in CUSTOM mode.

Language Setting

Language setting can be varied with some DVDs or DivX® Subtitles recorded in discs.

- 1 Press the **SETUP** button in stop mode.
- 2 Press the **Cursor** buttons (◀ or ▶) to select **CUSTOM**, then press the **ENTER** button.
 - The custom mode will appear.
- 3 Press the **Cursor** buttons (◀ or ▶) to select **LANGUAGE**, then press the **ENTER** button to confirm.
- 4 Press the **Cursor** buttons (▲ or ▼) to select an item, then press the **ENTER** button.

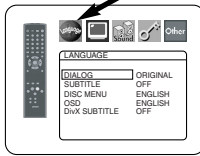

DIALOG (Default : ORIGINAL)

- Sets the audio language.

SUBTITLE (Default : OFF)

- Sets the subtitle language.

DISC MENU (Default : ENGLISH)

- Sets the language for DVD Menu and title menu (for DivX®).

OSD (Default : ENGLISH) **QUICK**

- Sets the language for the On-Screen display.

DivX SUBTITLE (Default: OFF)

- Sets the DivX® subtitle language.

- 5 Press the **Cursor** buttons (▲ or ▼) to select a setting, then press the **ENTER** button.
 - If OTHER is selected in the DIALOG, SUBTITLE or DISC MENU, press four-digit number to enter the code for the desired language (refer to the language code list on page 32).
 - Only the languages supported by the disc can be selected.
- 6 Press the **SETUP** button to exit and activate the new settings.

NOTE:

- Language Setting for DIALOG and SUBTITLE may not be available with some discs. Then use the **AUDIO** and **SUBTITLE** buttons. Details are on page 26.

Display Setting

You can change certain aspects of the DVD display screens, still mode, TV Type, Progressive and HDMI settings.

- 1 Press the **SETUP** button in stop mode.
- 2 Press the **Cursor** buttons (◀ or ▶) to select **CUSTOM**, then press the **ENTER** button.
 - The custom mode will appear.
- 3 Press the **Cursor** buttons (◀ or ▶) to select **DISPLAY**, then press the **ENTER** button to confirm.
- 4 Press the **Cursor** buttons (▲ or ▼) to select an item, then press the **ENTER** button.

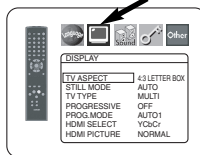

TV ASPECT (Default : 4:3 LETTER BOX) **QUICK**

- Press the **Cursor** buttons (▲ or ▼) for an item selection, then press the **ENTER** button.
- Select 4:3 LETTER BOX for a black bars appears on top and bottom of the screen.
- Select 4:3 PAN & SCAN for a full height picture with both sides trimmed.
- Select 16:9 WIDE if a wide-screen TV is connected to the DVD player.
- Select 4:3 SQUEEZE when the TV screen is too large horizontally at 16:9 WIDE setting and when it is impossible to adjust the screen size using the TV's controls.

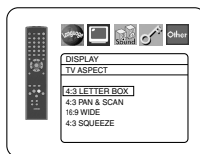

STILL MODE (Default : AUTO)

- Press the **Cursor** buttons (▲ or ▼) for an item selection (AUTO, FIELD, or FRAME), then press the **ENTER** button.
- This function allows you to adjust picture resolution and quality in still mode.
- An individual picture on TV screen is called as "frame", which consists of two separate images called as "field". Some pictures may be blurred at the AUTO setting in still mode due to their data characteristics.
- **AUTO**: Automatically selects the best resolution setting (FRAME or FIELD) based on the data characteristics of the pictures.
- **FIELD**: Select FIELD when the pictures are still unstable even if AUTO is selected. FIELD stabilizes the pictures, although the picture quality may become coarse due to the limited amount of data.
- **FRAME**: Select FRAME to display relatively motionless pictures in higher resolution. FRAME improves the picture quality, although it may unstabilize the pictures due to simultaneous output of two field data.

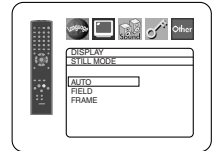

TV TYPE (DEFAULT: MULTI)

- Press the **Cursor** buttons (▲ or ▼) to select a setting, then press the **ENTER** button.
- Select a video system setting between MULTI, NTSC and PAL.
- **NTSC**: Select this when your TV's video format is NTSC. If NTSC is selected, output format is fixed to NTSC.
- **PAL**: Select this when your TV's video format is PAL. If PAL is selected, output format is fixed to PAL.
- **MULTI**: Automatically selects the suitable video out system (PAL/NTSC) according to the format of the inserted disc.
 - For the discs recorded with NTSC system, the NTSC signal will be output and pictures of the discs can be viewed on an NTSC or Multi system TV.
 - For the discs recorded with PAL system, the PAL signal will be output and pictures of the discs can be viewed on a PAL system TV or Multi system TV.

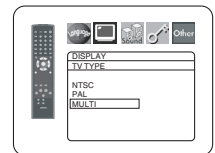

NOTES:

- If the AC power cord is disconnected while the unit is turned on, the video format of opening screen is altered. To keep the format, turn the unit off before unplugging the AC power cord.
- When PAL signal is output from this unit, the image of on-screen display will be distorted or will not be displayed at all. To bring back the on-screen display, select MULTI using the **DIMMER NTSC/PAL** button on the front panel then play a disc recorded in NTSC system, or select NTSC. Refer to TV TYPE on page 17.

PROGRESSIVE

(Default: OFF) **QUICK**

- Press the **Cursor** buttons (▲ or ▼) to set **PROGRESSIVE** to ON or OFF, then press the **ENTER** button.
- The setting will be effective when you exit the setup screen by pressing the **SETUP** button.
- When **PROGRESSIVE** is ON, P.SCAN appears on the DVD player's display after you exit the setup screen.
- Refer to page 12 for more details.
- In the HDMI output mode, even when **PROGRESSIVE** is set to ON, signals are output always as Interlace.

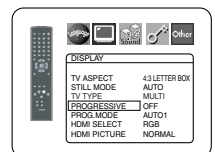

PROG.MODE (Default: AUTO1)

- Press the **Cursor** buttons (▲ or ▼) to select a mode for the progressive scan output, then press the **ENTER** button.
- AUTO1: mode suitable for images on the film material.
- AUTO2: mode for images on the material of 30-frame film.
- VIDEO1: mode for normal video material.
- VIDEO2: mode for video material with less movements.
- VIDEO3: mode for video material with many movements.

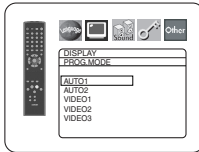

HDMI SELECT (Default: YCbCr)

- Select an HDMI output mode between YCbCr and RGB.
- When the connected equipment is not compatible with YCbCr, HDMI signal is output as RGB regardless of the setting.

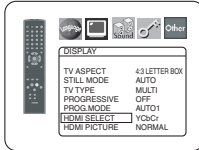

HDMI PICTURE (Default: NORMAL)

- Select a HDMI picture mode between NORMAL and ENHANCED.
- Select ENHANCED if the black-white contrast is not clear.
- This setting is effective only for HDMI RGB output.

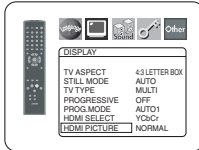

5 Press the **SETUP** button to exit and activate the new settings.

NOTE:

- Be sure to press the **SETUP** button, or the setting will not work.

Audio Setting

You can change some Audio settings. It only affects during the playback of DVD discs.

- 1 Press the **SETUP** button in stop mode.
- 2 Press the **Cursor** buttons (◀ or ▶) to select **CUSTOM**, then press the **ENTER** button.
 - The custom mode will appear.
- 3 Press the **Cursor** buttons (◀ or ▶) to select **AUDIO**, then the **ENTER** button to confirm.
- 4 Press the **Cursor** buttons (▲ or ▼) button to select an item, then press the **ENTER** button.
 - This menu display contains 2 pages. Press the **Cursor** button (▼) repeatedly to show the next page.

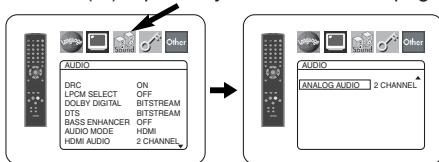

DRC (Dynamic Range Control) (Default : ON)

- DRC function compresses the range of sound volume.
- DRC function is available only on the discs that are recorded in the Dolby Digital format.

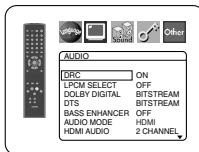

LPCM SELECT (Default : OFF)

- Set to ON when outputting in 48kHz.
- This function is available only on digital outputting of a disc recorded in 96kHz.
- Sounds of the DVD-Audio which exceed 96kHz will be output as 96kHz even if LPCM SELECT is set to OFF.
- This function is not effective for the HDMI sound output.

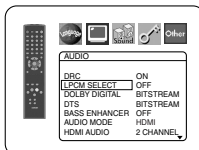

When playing disc with copyright protection

- The sound will be down sampled at 48kHz, even if you set to OFF.

DOLBY DIGITAL (Default: BITSTREAM) QUICK

- Set to BITSTREAM when the player is connected to a Dolby Digital decoder.
 - This function is effective only for the COAXIAL, OPTICAL and HDMI connections.
- BITSTREAM:**
DOLBY DIGITAL signals are output as Bitstream.
- For HDMI connection, if the connected equipment is not compatible with the Dolby Digital BITSTREAM, the signals are output as PCM regardless of the setting.
- PCM:** Convert Dolby Digital to PCM.

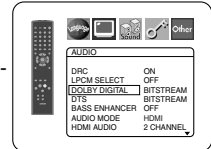

DTS (Default : BITSTREAM) QUICK

- Set to BITSTREAM when the unit is connected to a DTS decoder.
- BITSTREAM:**
DTS signals are output as Bitstream.
- For HDMI connection, if the connected equipment is not compatible with the DTS Bitstream, the signals are output as PCM regardless of the setting.
- PCM:** Convert DTS to PCM.

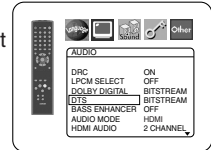

BASS ENHANCER (Default: OFF)

- Set to ON for sound output on the bass-woofer channel when 2-channel audio source is played back.
- This function is effective only for the 5.1ch AUDIO OUT jacks. Set the AUDIO MODE to ANALOG and ANALOG AUDIO to MULTI CHANNEL to set this function.
- When SUB WOOFER is set to NONE in the Speaker Configuration, BASS ENHANCER will be set to OFF automatically.

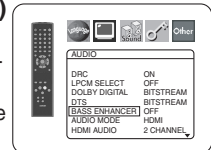

AUDIO MODE (Default: HDMI)

- Select the sound is output from whether HDMI jacks or 5.1ch AUDIO OUT jacks.
- HDMI:** Sound is output via HDMI connection. Output from 5.1ch AUDIO OUT connection may be restricted.

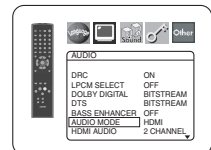

ANALOG: Sound is output via 5.1ch AUDIO OUT jacks. Output from HDMI connection is cut off.

- Set to ANALOG when Super Audio CD is played back.

HDMI AUDIO (Default: 2 CHANNEL)

- Select the number of channels for HDMI audio output between 2 CHANNEL and MULTI CHANNEL.
- Refer to the table on page 16 for the actual output settings.
- Connect appropriate external equipment for each setting and set AUDIO MODE to HDMI beforehand to perform this setting.

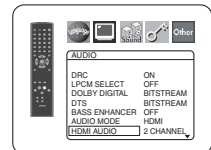

2 CHANNEL:

2 channel signals are output from HDMI OUT jack. Suitable for monitors or projectors compatible with HDMI 2CH.

MULTI CHANNEL:

Multi channel signals are output from HDMI OUT jack. Suitable for monitors or amplifiers compatible with HDMI multi channels.

- When MULTI CHANNEL is selected, the Speaker setting menu for HDMI AUDIO will appear (refer to page 31).

ANALOG AUDIO (Default : 2 CHANNEL)

- Set AUDIO MODE to ANALOG beforehand to perform this setting.
- 2 CHANNEL: Output 2ch sound from the 5.1ch AUDIO OUT jacks.
- MULTI CHANNEL: Output Multi channel sound from the 5.1ch AUDIO OUT jacks.

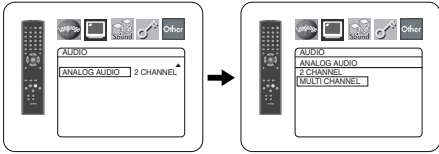

5 Press the **SETUP** button to exit and activate the new settings.

Speaker Setting for ANALOG AUDIO

When MULTI CHANNEL is selected for ANALOG AUDIO, some speaker settings will be required.

- Set AUDIO MODE to ANALOG beforehand to perform this setting.
- 1 Press the **Cursor** buttons (▲ or ▼) to select MULTI CHANNEL, then press the **ENTER** button.
- 2 Press the **Cursor** buttons (▲ or ▼) to select the below items, then press the **ENTER** button.
 - The custom mode will appear.

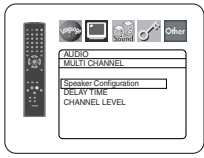

Speaker Configuration

- Press the **Cursor** buttons (▲ or ▼) to select the speaker to set, then press the **ENTER** button.
- Press the **Cursor** buttons (▲ or ▼) button to select the speaker size, then press the **ENTER** button.

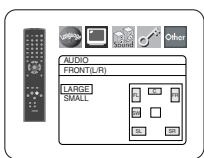
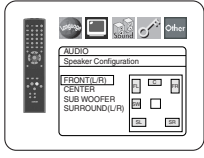

FRONT(L/R), CENTER, SURROUND(L/R)

- LARGE: Select this when the connected speaker is capable of playing back sounds of 100Hz or more.
- SMALL: Select this when the connected speaker is capable of playing back sounds less than 100Hz.
- NONE: Select this when it is not connected. (It cannot be set NONE on the FRONT speaker.)

SUB WOOFER

- YES: Select this when SUB WOOFER is connected.
- NONE: Select this when it is not connected.

NOTES:

- NONE is not available for SUB WOOFER when SMALL is selected for FRONT (L/R).
- SMALL is not available for FRONT (L/R) when NONE is selected for SUB WOOFER.
- ON is not available for BASS ENHANCER when NONE is selected for SUB WOOFER.
- When playing back DVD audio, the sound may not come out as set due to restrictions in the disc or the player.

DELAY TIME

With 5.1-channel surround sound, ideally the distance between the listening position and all the speakers (exclude Sub woofer). The delay time setting can be used to make the sound from the different speakers reach the listening position at the same time.

Use the **Cursor** buttons (▲ or ▼) to select the setting item, then press the **ENTER** button.

- Press the **Cursor** buttons (▲ or ▼) to select the speaker to set, then press the **ENTER** button.

DISTANCE (Default : FEET)

METERS (when the **ENTER** button is pressed):
The unit of distance is set to meters (m).
FEET (when the **ENTER** button is pressed):
The unit of distance is set to feet (ft).

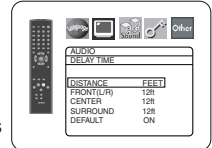

FRONT(L/R), CENTER, SURROUND(L/R) (DEFAULT : 12ft)

FRONT(L/R):
The distance can be set within the range of 0 to 60 feet.
CENTER, SURROUND:
These are depends on the setting value of FRONT(L/R).

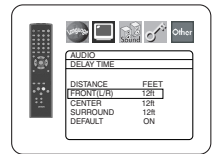

NOTES:

- It is not possible to adjust this item if CENTER and SURROUND have been set to NONE in the Speaker Configuration setting.
- When DEFAULT is selected and the **ENTER** button is pressed, all the items are restored to their factory default settings.

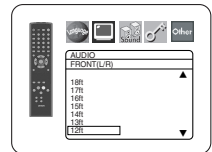

CHANNEL LEVEL

When the channel level differs from each speaker, the adjustment can be made in the unit of dB (-12dB to 0dB).

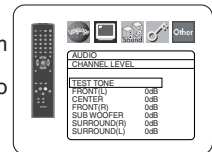

TEST TONE:

- Press the **Cursor** buttons (▲ or ▼) to select TEST TONE, then press the **ENTER** button.
The test tone will output from each speaker in turn.

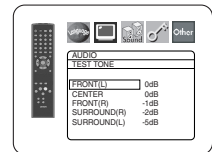

CHANNEL LEVEL:

- Press the **Cursor** buttons (▲ or ▼) to select the speaker to set, then press the **ENTER** button.
- Press the **Cursor** buttons (▲ or ▼) to select the desired level for each speaker, then press the **ENTER** button.

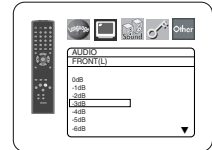

NOTES:

- While the test tone is being output, the channel balance adjustment cannot be made.
- When TEST TONE is selected, no test tone will be output from SUBWOOFER.
- It is not possible to adjust this item for the speaker that has been set to NONE in Speaker Configuration setting.

3 Press the **SETUP** button to exit.

Speaker Setting for HDMI AUDIO

When HDMI AUDIO is selected for MULTI CHANNEL, the bass management setting menu will appear. Set the Speaker Configuration, delay time and channel level for each speakers (front, center, surround and sub woofer).

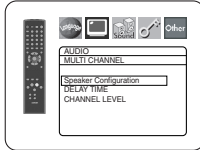

Speaker Configuration

Set the size of each speaker between LARGE and SMALL.

- The presence of the speakers is detected automatically. Set the detected speakers' size.
- When a speaker is not detected, it's size is set as NONE.
- Once a speaker is detected, you cannot set it to NONE.
- The default setting is LARGE.
- During HDMI audio output, the sound output via analog channels may be restricted.

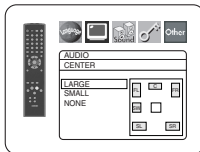
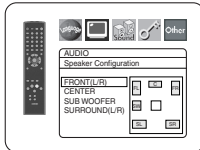

DELAY TIME

Same as DELAY TIME setting for "Speaker Setting for ANALOG AUDIO" on page 30.

CHANNEL LEVEL

Same as CHANNEL LEVEL setting for "Speaker Setting for ANALOG AUDIO" on page 30.

Ratings Control

Ratings Control allows you to set a limit, which prevents your children from viewing inappropriate materials on DVDs. A four-digit password that you establish will give you the control.

RATING LEVEL

You can set a viewing limit through Rating Level. Playback of the discs will stop if the disc's general rating exceeds the limit you set.

- 1 Press the **SETUP** button in stop mode.
- 2 Press the **Cursor** buttons (◀ or ▶) to select **CUSTOM**, then press the **ENTER** button.
 - The custom mode will appear.
- 3 Press the **Cursor** buttons (◀ or ▶) to select **RATINGS**, then press the **ENTER** button.
- 4 Press the **Numeric** buttons to enter your four-digit password.

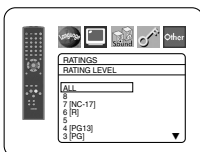
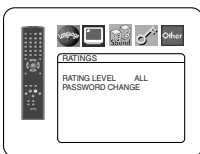

- When doing this for the first time, enter any four-digit number by pressing the **Numeric** buttons (except for 4737), then press the **ENTER** button. That number will be used as the password from the second time onward. Record your password in case you forget it.

- 5 Press the **Cursor** buttons (▲ or ▼) to select **RATING LEVEL**, then press the **ENTER** button.
- 6 Press the **Cursor** buttons (▲ or ▼) to select a desired level, then press the **ENTER** button.
- 7 Press the **SETUP** button to exit and activate the new settings.

NOTES:

- This function may not work on some DVDs. Be sure if the RATINGS operates in the way you have set.
- The resume information will be cleared if you change the parental level when the resume information is on.

To Change the Password:

- 1) Follow the steps **1** to **4** above.
- 2) Press the **Cursor** buttons (▲ or ▼) to select **PASSWORD CHANGE**, then press the **ENTER** button.
- 3) Enter a new four-digit password, then press the **ENTER** button.
- 4) Press the **SETUP** button to exit.

IF YOU FORGET THE PASSWORD

- 1 Press **4, 7, 3, 7** at step **4**.
 - Password will be cleared and rating level will be set to ALL.
- 2 Repeat steps **4** to **7** to re-establish the parental lock.

CONTROL LEVELS

- **ALL**
Parental lock is canceled.
- **Level 8**
DVD software of any grade (adult/general/children) can be played back.
- **Levels 7 to 2**
Only DVD software intended for general use and children can be played back.
- **Level 1**
Only DVD software intended for children can be played back, with those intended for adult and general use prohibited.

Others Setting

This function allows you to adjust Angle Icon availability, Auto Power off, brightness of the Player's display panel, slide show mode, to obtain DivX® registration code and DVD-Audio player mode.

- 1 Press the **SETUP** button in stop mode.
- 2 Press the **Cursor** buttons (◀ or ▶) to select **CUSTOM**, then press **ENTER**.
 - The custom mode will appear.
- 3 Press the **Cursor** buttons (◀ or ▶) to select **Other**, then press the **ENTER** button to confirm.
- 4 Press the **Cursor** buttons (▲ or ▼) to select an item, then press **ENTER**.

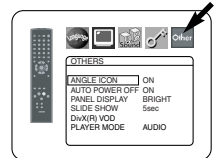

ANGLE ICON (Default : ON)

- Press the **ENTER** button repeatedly to turn ON or OFF.



AUTO POWER OFF (Default : ON)

- Press the **ENTER** button repeatedly to turn ON or OFF.
- It will turn off the DVD player automatically after 30 minutes of no use.



PANEL DISPLAY (Default : BRIGHT)

- Press the **Cursor** buttons (▲ or ▼) to select a setting (BRIGHT, DIMMER and AUTO), then press the **ENTER** button.
- When AUTO is selected, the display dims only during playback.

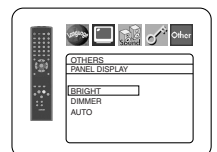

DVD SETUP

SLIDE SHOW (Default : 5sec)

- This adjusts the playback speed of the JPEG SLIDE SHOW.
- Press the **Cursor** buttons (▲ or ▼) to select between 5 sec and 10 sec, then press the **ENTER** button.

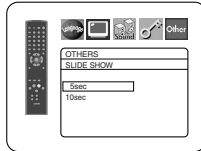

DivX(R) VOD

- This player allows you to use the DivX® Video-On-Demand (VOD) services. You can play back the files purchased or rental from the VOD services. You need to have a registration code to purchase or rental VOD files. Please visit www.divx.com/vod for more details.

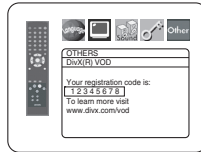

PLAYER MODE (Default : AUDIO)

- Press the **ENTER** button repeatedly to select AUDIO or VIDEO.
- AUDIO:** Select to play back general contents of DVD-Audio.
- VIDEO:** Select to play back DVD-Video contents included in DVD-Audio.

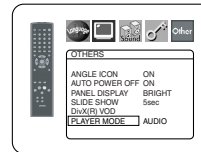

NOTES:

- You cannot play back the DivX® VOD files obtained with different registration codes on this player.
- You cannot play back the DivX® VOD files, of which rental period has been expired. In such case, press the **MENU** button and select other files that can be played back.

- Some DivX® VOD files are restricted with the limited playable times (you cannot play them back beyond the limit). If your DivX® VOD file has such limit, the playback confirmation screen will appear. Use the **Cursor** buttons (◀ or ▶) to select YES if you want to play back the file, or to select NO if you do not wish to play it back. Then, press the **ENTER** button to confirm the selection.
- Please send your inquiries regarding the VOD files to DivX®, Inc.

5 Press the **SETUP** button to exit.

Reset to the Default Settings (except for Ratings Control)

This allows you to return all selections of SETUP (except for RATINGS) to their default settings.

- Press the **SETUP** button in stop mode.
- Press the **Cursor** buttons (◀ or ▶) to select **INITIALIZE**, then press the **ENTER** button.
- Press the **Cursor** buttons (▲ or ▼) to select **YES**, then press the **ENTER** button.
- Press the **SETUP** button to exit.

NOTE:

- If you do not wish to initialize, select NO at step 3.

Language Code List

Language	Code	Language	Code	Language	Code	Language	Code
	A-B						
Abkhazian	4748	French [FRE]	5264	Macedonian	5957	Siswat	6565
Afar	4747	Frisian	5271	Malagasy	5953	Slovak [SLO]	6557
Afrikaans	4752	Galician	5358	Malay	5965	Slovenian	6558
Albanian	6563	Georgian	5747	Malayalam	5958	Somali	6561
Amharic	4759	German [GER]	5051	Maltese	5966	Spanish [SPA]	5165
Arabic	4764	Greek [GRE]	5158	Maori	5955	Sundanese	6567
Armenian	5471	Greenlandic	5758	Marathi	5964	Swahili	6569
Assamese	4765	Guarani	5360	Moldavian	5961	Swedish [SWE]	6568
Aymara	4771	Gujarati	5367	Mongolian	5960		T
Azerbaijani	4772	Hausa	5447	Nauru	6047	Tagalog	6658
Bashkir	4847	Hebrew	5569	Nepali	6051	Tajik	6653
Basque	5167	Hindi	5455	Norwegian [NOR]	6061	Tamil	6647
Bengali; Bangla	4860	Hungarian [HUN]	5467		O-R	Tatar	6666
Bhutani	5072			Occitan	6149	Telugu	6651
Bihari	4854	Icelandic [ICE]	5565	Oriya	6164	Thai	6654
Bislama	4855	Indonesian	5560	Oromo (Afan)	6159	Tibetan	4861
Breton	4864	Interlingua	5547	Panjabi	6247	Tigrinya	6655
Bulgarian [BUL]	4853	Interlingue	5551	Pashto; Pushto	6265	Tonga	6661
Burmese	5971	Inupiak	5557	Persian	5247	Tsonga	6665
Byelorussian	4851	Irish [IRI]	5347	Polish [POL]	6258	Turkish [TUR]	6664
	C-E	Italian [ITA]	5566	Portuguese [POR]	6266	Turkmen	6657
Cambodian	5759	Japanese [JPN]	5647	Quechua	6367	Twi	6669
Catalan	4947	Javanese	5669	Rhaeto-Romance	6459		U-Z
Chinese [CHI]	7254	Kannada	5760	Romanian [RUM]	6461	Ukrainian	6757
Corsican	4961	Kashmiri	5765	Russian [RUS]	6467	Urdu	6764
Croatian	5464	Kazakh	5757		S	Uzbek	6772
Czech [CZE]	4965	Kinyarwanda	6469	Samoan	6559	Vietnamese	6855
Danish [DAN]	5047	Kirghiz	5771	Sangho	6553	Volapuk	6861
Dutch [DUT]	6058	Kirundi	6460	Sanskrit	6547	Welsh	4971
English [ENG]	5160	Korean [KOR]	5761	Scots Gaelic	5350	Wolof	6961
Esperanto	5161	Kurdish	5767	Serbian	6564	Xhosa	7054
Estonian	5166			Serbo-Croatian	6554	Yiddish	5655
	F-H	Laothian	5861	Sesotho	6566	Yoruba	7161
Faroese	5261	Latin	5847	Setswana	6660	Zulu	7267
Fiji	5256	Latvian; Lettish	5868	Shona	6560		
Finnish [FIN]	5255	Lingala	5860	Sindhi	6550		
		Lithuanian	5866	Singhalese	6555		

If you choose a language that has a three-letter language code (written in bracket), the code will be displayed every time you change the Audio or Subtitle Language setting on page 26. If you choose any other languages, '---' will be displayed instead.

TROUBLESHOOTING GUIDE

If the DVD player does not perform properly when operated as instructed in this Operating Instruction, check the player, consulting the following checklist.

Problem	Solution	Page
No power	<ul style="list-style-type: none"> - Check if the AC power cord is properly connected. - Unplug the AC cord once, and wait for 5-10 seconds and then plug it in again. 	<ul style="list-style-type: none"> - -
No sound or picture	<ul style="list-style-type: none"> - Check if the TV is turned on. - Check the video and HDMI connection. - Check the AUDIO/VIDEO cable connections. - Check if the PURE DIRECT is set to ON. If it is the case, set it to OFF - Check if the PROGRESSIVE mode is set correctly. 	<ul style="list-style-type: none"> - 15, 16 13-15 17 12, 28
Distorted picture	<ul style="list-style-type: none"> - Sometimes a small amount of picture distortion may appear. This is not a malfunction. - Connect the DVD player directly to the TV. - Check if the PROGRESSIVE mode is set correctly. - Check the TV TYPE. (MULTI, NTSC or PAL) 	<ul style="list-style-type: none"> - 15 12, 28 17, 28
Completely distorted picture or black/white picture with DVD	<ul style="list-style-type: none"> - Connect the DVD player directly to the TV. - Make sure the disc is compatible with the DVD player. 	<ul style="list-style-type: none"> 15 6
No sound or distorted sound	<ul style="list-style-type: none"> - Adjust the volume. - Check that the speakers are connected correctly. - The HDMI sound is not output during PURE DIRECT or when AUDIO MODE is set to ANALOG. 	<ul style="list-style-type: none"> - 13-15 17, 29
No audio at digital output	<ul style="list-style-type: none"> - Check the digital connections. - Check the audio settings. - Digital signals cannot be output with Super Audio CDs. Use analog connections. - Area/layer of Super audio CD being played (MULTI / STEREO / CD) does not match amplifier connections. 	<ul style="list-style-type: none"> 13, 16 29,30 13, 16 -
No image from HDMI connection	<ul style="list-style-type: none"> - Check the HDMI connection. (Check the status of the HDMI related indications.) - Check whether the connected monitor equipment or other equipment supports HDCP. (This player will not output a video signal unless the other equipment supports HDCP.) - Connect the DVD player to the display equipment using the Audio/Video cables (supplied), and check the HDMI settings. - Check whether the output format of this player (HDMI FORMAT) matches the supported input format of other connected equipment. - Check if the PURE DIRECT is set to ON. If it is the case, set it to OFF. 	<ul style="list-style-type: none"> 16, 17 16 13-16, 29 16 17
Picture freezes momentarily during playback	<ul style="list-style-type: none"> - Check the disc for fingerprints/scratches and clean with a soft cloth wiping from centre to edge. - Clean the disc. 	<ul style="list-style-type: none"> 34 34
Disc cannot be played back	<ul style="list-style-type: none"> - Clean the disc. - Ensure the disc label is facing up. - Check if the disc is defective by trying another disc. - Cancel the ratings control or change the control level. - Insert a correct disc that can be played back on this player. 	<ul style="list-style-type: none"> 34 17 - 31 6
No return to start-up screen when disc is removed	<ul style="list-style-type: none"> - Reset the player by turning it off, then on again. 	<ul style="list-style-type: none"> -
The DVD player does not respond to the remote control	<ul style="list-style-type: none"> - Aim the remote control directly at the sensor on the front of the player. - Reduce the distance to the player. - Replace the batteries in the remote control. - Re-insert the batteries with their polarities (+/- signs) as indicated. 	<ul style="list-style-type: none"> 11 - 11 11
Buttons do not work or the player stops responding	<ul style="list-style-type: none"> - To completely reset the player, unplug the AC cord from the AC outlet for 5-10 seconds. 	<ul style="list-style-type: none"> -
The DVD player does not respond to some operating commands during playback	<ul style="list-style-type: none"> - Operations may not be permitted by the disc. Refer to the instructions of the disc. 	<ul style="list-style-type: none"> 6
The DVD player cannot read CDs/DVDs	<ul style="list-style-type: none"> - Use a commonly available CD/DVD cleaner to clean the lens before sending the DVD player for repair. 	<ul style="list-style-type: none"> 34
Angle does not switch	<ul style="list-style-type: none"> - The angle cannot be switched for DVDs which do not contain multiple angles. In some cases multiple angles are only recorded for specific scenes. 	<ul style="list-style-type: none"> 26
Playback does not start when the title is selected	<ul style="list-style-type: none"> - Check the "RATINGS" setting. 	<ul style="list-style-type: none"> 31
The password for rating level has been forgotten	<ul style="list-style-type: none"> - Enter the default password "4737", then your forgotten password will be cleared. 	<ul style="list-style-type: none"> 31

NOTES:

- Some functions are not available in specific modes, but this is not a malfunction. Read the description in this Operating Instruction for details on correct operations.
- Playback from a desired track and random playback are not available during program playback.
- Some functions are prohibited on some discs.

SPECIFICATIONS

SIGNAL SYSTEM

NTSC/PAL color

APPLICABLE DISCS

- (1) DVD-Video/DVD-Audio Discs
1-layer 12cm single-sided discs, 2-layer 12cm single-sided discs, 2-layer 12cm double-sided discs (1 layer per side)
1-layer 8cm single-sided discs, 2-layer 8cm single-sided discs, 2-layer 8cm double-sided discs (1 layer per side)
- (2) Super Audio CD
- (3) DVD-R/DVD-RW
- (4) Compact discs (Audio CD)
12cm discs, 8cm discs
- (5) CD-R/CD-RW

S-VIDEO OUTPUT

Y output level: 1Vp-p (75Ω/ohms)
C output level: 0.286Vp-p
Output connectors: S connectors, 1 set

VIDEO OUTPUT

Output level: 1Vp-p (75Ω/ohms)
Output connector: Pin jacks, 1 set

COMPONENT OUTPUT

Y output level: 1Vp-p (75Ω/ohms)
PB/CB output level: 0.648Vp-p (75Ω/ohms)
PR/CR output level: 0.648Vp-p (75Ω/ohms)
Output connector: Pin jacks, 1 set

HDMI OUTPUT

HDMI jack, 1 set

AUDIO OUTPUT

Output level: 2Vrms
2 channel (L, R) output connector: Pin jack, 1 set
Multi channel (FL, FR, C, SL, SR, SW): Pin jack, 1 set

AUDIO OUTPUT PROPERTIES

- (1) Frequency response
1 DVDs (linear PCM) : 4Hz to 22kHz (48kHz sampling)
: 4Hz to 44kHz (96kHz sampling)
: 4Hz to 88kHz (192kHz sampling)
2 CDs : 4Hz to 20kHz
3 Super Audio CD : 4Hz to 100kHz
- (2) S/N ratio : 115dB
- (3) Total harmonic distortion : 1kHz CD: 0.004%
- (4) Dynamic range : DVD: 100dB
CD: 98dB

DIGITAL AUDIO OUTPUT

Optical digital output: Optical connector, 1 set
Coaxial digital output: Pin jack, 1 set

POWER SUPPLY

AC 120V, 60Hz

POWER CONSUMPTION

15W (Standby: 0.4W)

MAXIMUM EXTERNAL DIMENSIONS

W: 17-3/32" (435mm)
H: 2-61/64" (75mm)
D: 12-13/64" (310mm)
(including protruding parts)

MASS

5.72 lbs (2.6 kg)

REMOTE CONTROL UNIT

RC-1017
Infrared pulse type
Supply: DC 3V, 2 R6P/AA batteries

MAINTENANCE

Cleaning the Cabinet

- Use a soft cloth slightly moistened with a mild detergent solution. Do not use a solution containing alcohol, spirits, ammonia or abrasives.

Cleaning Discs

- When a disc becomes dirty, clean it with a cleaning cloth. Wipe the disc from the center out. Do not wipe in a circular motion.
- Do not use solvents such as benzene, thinner, commercially available cleaners, detergent, abrasive cleaning agents or antistatic spray intended for analogue records.

Cleaning the disc lens

- If the player still does not perform properly when it is operated while referring to the relevant sections and to "TROUBLESHOOTING GUIDE" in this Operating Instruction, the laser optical pickup unit may be dirty. Consult your dealer or an Authorized Service Center for inspection and cleaning of the laser optical pickup unit.

Disc Handling

- Use discs which have the following logos on them.
- Handle the discs so that fingerprints and dust do not adhere to the surfaces of the discs.
- Always store the disc in its protective case when it is not used.
- Note that discs with special shapes (heart-shaped discs, octagonal discs, etc.) cannot be played on this product. Do not attempt to play such discs, as they may damage the player.



Printed in China
00D 511 4661 107

DENON
TOKYO, JAPAN
www.denon.com

Denon Brand Company, D&M Holdings Inc.
1VMN23656A
E6EG0UD ****

Free Manuals Download Website

<http://myh66.com>

<http://usermanuals.us>

<http://www.somanuals.com>

<http://www.4manuals.cc>

<http://www.manual-lib.com>

<http://www.404manual.com>

<http://www.luxmanual.com>

<http://aubethermostatmanual.com>

Golf course search by state

<http://golfingnear.com>

Email search by domain

<http://emailbydomain.com>

Auto manuals search

<http://auto.somanuals.com>

TV manuals search

<http://tv.somanuals.com>