

DENON

AV SURROUND RECEIVER

AVR-1403/483

OPERATING INSTRUCTIONS MODE D'EMPLOI

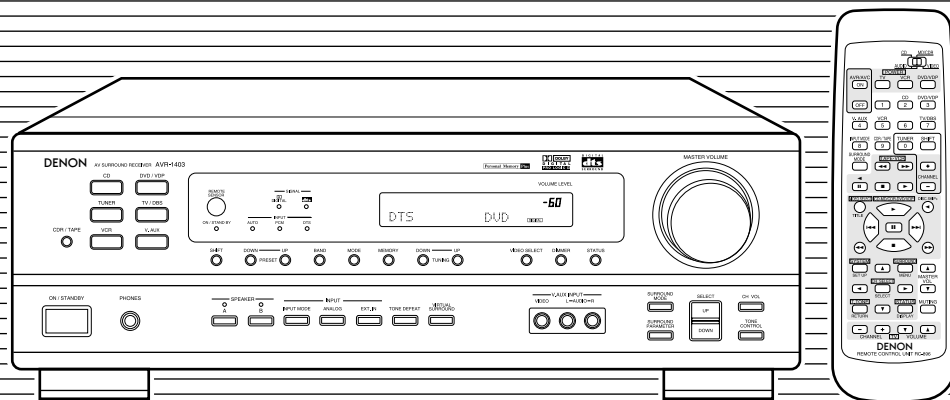

FOR ENGLISH READERS PAGE 2 ~ PAGE 47, 92, 93

- We greatly appreciate your purchase of this unit.
- To be sure you take maximum advantage of all the features this unit has to offer, read these instructions carefully and use the set properly. Be sure to keep this manual for future reference should any questions or problems arise.

"SERIAL NO. _____

PLEASE RECORD UNIT SERIAL NUMBER ATTACHED TO THE REAR OF THE CABINET FOR FUTURE REFERENCE"

POUR LES LECTEURS FRANCAIS PAGE 2, 48 ~ PAGE 93

- Nous vous remercions pour l'achat de cet appareil.
- Pour être sûr de profiter au maximum de toutes les caractéristiques qu'offre cet appareil, lire avec soin ces instructions et bien utiliser l'appareil. Toujours conserver ce mode d'emploi pour s'y référer ultérieurement en cas de question ou de problème.

"NO. DE SERIE _____

PRIERE DE NOTER LE NUMERO DE SERIE DE L'APPAREIL INSCRIT A L'ARRIERE DU COFFRET DE FAÇON A POUVOIR LE CONSULTER EN CAS DE PROBLEME."

■ SAFETY PRECAUTIONS

CAUTION

RISK OF ELECTRIC SHOCK
DO NOT OPEN

CAUTION: TO REDUCE THE RISK OF ELECTRIC SHOCK, DO NOT REMOVE COVER (OR BACK). NO USER-SERVICEABLE PARTS INSIDE. REFER SERVICING TO QUALIFIED SERVICE PERSONNEL.

The lightning flash with arrowhead symbol, within an equilateral triangle, is intended to alert the user to the presence of uninsulated "dangerous voltage" within the product's enclosure that may be of sufficient magnitude to constitute a risk of electric shock to persons.

The exclamation point within an equilateral triangle is intended to alert the user to the presence of important operating and maintenance (servicing) instructions in the literature accompanying the appliance.

WARNING: TO REDUCE THE RISK OF FIRE OR ELECTRIC SHOCK, DO NOT EXPOSE THIS APPLIANCE TO RAIN OR MOISTURE.

CAUTION

TO PREVENT ELECTRIC SHOCK, MATCH WIDE BLADE OF PLUG TO WIDE SLOT, FULLY INSERT.

ATTENTION

POUR ÉVITER LES CHOCS ÉLECTRIQUES, INTERODUIRE LA LAME LA PLUS LARGE DE LA FICHE DANS LA BORNE CORRESPONDANTE DE LA PRISE ET POUSSER JUSQU' AU FOND.

This device complies with Part 15 of the FCC Rules. Operation is subject to the following two conditions: (1) This device may not cause harmful interference, and (2) this device must accept any interference received, including interference that may cause undesired operation.

This Class B digital apparatus meets all requirements of the Canadian Interference-Causing Equipment Regulations.

Cet appareil numérique de la classe B respecte toutes les exigences du Règlement sur le matériel brouilleur du Canada.

■ NOTE ON USE / OBSERVATIONS RELATIVES A L'UTILISATION

- Avoid high temperatures. Allow for sufficient heat dispersion when installed on a rack.
- Éviter des températures élevées. Tenir compte d'une dispersion de chaleur suffisante lors de l'installation sur une étagère.

- Keep the set free from moisture, water, and dust.
- Protéger l'appareil contre l'humidité, l'eau et la poussière.

- Do not let foreign objects in the set.
- Ne pas laisser des objets étrangers dans l'appareil.

- Handle the power cord carefully. Hold the plug when unplugging the cord.
- Manipuler le cordon d'alimentation avec précaution. Tenir la prise lors du débranchement du cordon.

- Unplug the power cord when not using the set for long periods of time.
- Débrancher le cordon d'alimentation lorsque l'appareil n'est pas utilisé pendant de longues périodes.

- Do not let insecticides, benzene, and thinner come in contact with the set.
- Ne pas mettre en contact des insecticides, du benzène et un diluant avec l'appareil.

* (For sets with ventilation holes)

- Do not obstruct the ventilation holes.
- Ne pas obstruer les trous d'aération.

- Never disassemble or modify the set in any way.
- Ne jamais démonter ou modifier l'appareil d'une manière ou d'une autre.

SAFETY INSTRUCTIONS

1. Read Instructions – All the safety and operating instructions should be read before the product is operated.
2. Retain Instructions – The safety and operating instructions should be retained for future reference.
3. Heed Warnings – All warnings on the product and in the operating instructions should be adhered to.
4. Follow Instructions – All operating and use instructions should be followed.
5. Cleaning – Unplug this product from the wall outlet before cleaning. Do not use liquid cleaners or aerosol cleaners.
6. Attachments – Do not use attachments not recommended by the product manufacturer as they may cause hazards.
7. Water and Moisture – Do not use this product near water – for example, near a bath tub, wash bowl, kitchen sink, or laundry tub; in a wet basement; or near a swimming pool; and the like.
8. Accessories – Do not place this product on an unstable cart, stand, tripod, bracket, or table. The product may fall, causing serious injury to a child or adult, and serious damage to the product. Use only with a cart, stand, tripod, bracket, or table recommended by the manufacturer, or sold with the product. Any mounting of the product should follow the manufacturer's instructions, and should use a mounting accessory recommended by the manufacturer.
9. A product and cart combination should be moved with care. Quick stops, excessive force, and uneven surfaces may cause the product and cart combination to overturn.
10. Ventilation – Slots and openings in the cabinet are provided for ventilation and to ensure reliable operation of the product and to protect it from overheating, and these openings must not be blocked or covered. The openings should never be blocked by placing the product on a bed, sofa, rug, or other similar surface. This product should not be placed in a built-in installation such as a bookcase or rack unless proper ventilation is provided or the manufacturer's instructions have been adhered to.
11. Power Sources – This product should be operated only from the type of power source indicated on the marking label. If you are not sure of the type of power supply to your home, consult your product dealer or local power company. For products intended to operate from battery power, or other sources, refer to the operating instructions.
12. Grounding or Polarization – This product may be equipped with a polarized alternating-current line plug (a plug having one blade wider than the other). This plug will fit into the power outlet only one way. This is a safety feature. If you are unable to insert the plug fully into the outlet, try reversing the plug. If the plug should still fail to fit, contact your electrician to replace your obsolete outlet. Do not defeat the safety purpose of the polarized plug.



13. Power-Cord Protection – Power-supply cords should be routed so that they are not likely to be walked on or pinched by items placed upon or against them, paying particular attention to cords at plugs, convenience receptacles, and the point where they exit from the product.
15. Outdoor Antenna Grounding – If an outside antenna or cable system is connected to the product, be sure the antenna or cable system is grounded so as to provide some protection against voltage surges and built-up static charges. Article 810 of the National Electrical Code, ANSI/NFPA 70, provides information with regard to proper grounding of the mast and supporting structure, grounding of the lead-in wire to an antenna discharge unit, size of grounding conductors, location of antenna-discharge unit, connection to grounding electrodes, and requirements for the grounding electrode. See Figure A.
16. Lightning – For added protection for this product during a lightning storm, or when it is left unattended and unused for long periods of time, unplug it from the wall outlet and disconnect the antenna or cable system. This will prevent damage to the product due to lightning and power-line surges.
17. Power Lines – An outside antenna system should not be located in the vicinity of overhead power lines or other electric light or power circuits, or where it can fall into such power lines or circuits. When installing an outside antenna system, extreme care should be taken to keep from touching such power lines or circuits as contact with them might be fatal.
18. Overloading – Do not overload wall outlets, extension cords, or integral convenience receptacles as this can result in a risk of fire or electric shock.
19. Object and Liquid Entry – Never push objects of any kind into this product through openings as they may touch dangerous voltage points or short-out parts that could result in a fire or electric shock. Never spill liquid of any kind on the product.
20. Servicing – Do not attempt to service this product yourself as opening or removing covers may expose you to dangerous voltage or other hazards. Refer all servicing to qualified service personnel.
21. Damage Requiring Service – Unplug this product from the wall outlet and refer servicing to qualified service personnel under the following conditions:
 - a) When the power-supply cord or plug is damaged,
 - b) If liquid has been spilled, or objects have fallen into the product,
 - c) If the product has been exposed to rain or water,
 - d) If the product does not operate normally by following the operating instructions. Adjust only those controls that are covered by the operating instructions as an improper adjustment of other controls may result in damage and will often require extensive work by a qualified technician to restore the product to its normal operation,
 - e) If the product has been dropped or damaged in any way, and
 - f) When the product exhibits a distinct change in performance – this indicates a need for service.
22. Replacement Parts – When replacement parts are required, be sure the service technician has used replacement parts specified by the manufacturer or have the same characteristics as the original part. Unauthorized substitutions may result in fire, electric shock, or other hazards.
23. Safety Check – Upon completion of any service or repairs to this product, ask the service technician to perform safety checks to determine that the product is in proper operating condition.
24. Wall or Ceiling Mounting – The product should be mounted to a wall or ceiling only as recommended by the manufacturer.
25. Heat – The product should be situated away from heat sources such as radiators, heat registers, stoves, or other products (including amplifiers) that produce heat.

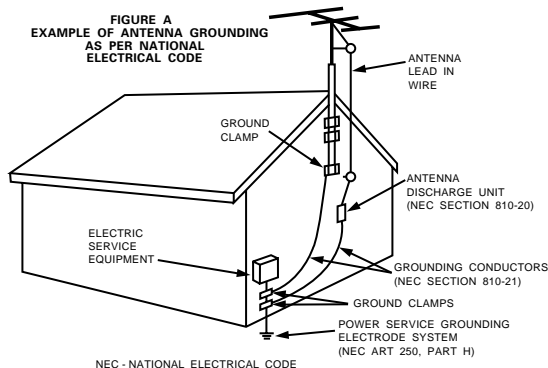

■ INTRODUCTION

Thank you for choosing the DENON A/V Surround receiver. This remarkable component has been engineered to provide superb surround sound listening with home theater sources such as DVD, as well as providing outstanding high fidelity reproduction of your favorite music sources. As this product is provided with an immense array of features, we recommend that before you begin hookup and operation that you review the contents of this manual before proceeding.

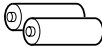

TABLE OF CONTENTS

1 Before Using4	11 Remote Control Unit21~23
2 Cautions on Installation5	12 Operation24~28
3 Cautions on Handling5	13 Surround.....29~33
4 Features.....5	14 DSP Surround Simulation.....34~38
5 Part Names and Functions6, 7	15 Listening to the Radio39~41
6 Read this first8	16 Last Function Memory42
7 Setting up the Speaker Systems.....8	17 Initialization of the Microprocessor.....42
8 Connections9~14	18 Additional Information43~45
9 Using the Remote Control Unit.....15	19 Troubleshooting46
10 Setting up the System16~20	20 Specifications47
	List of Preset Codes.....92, 93

■ ACCESSORIES

Check that the following parts are included in addition to the main unit:

1 Operating instructions1	5 R6P/AA batteries2
2 Warranty (for North America model only)1	6 AM loop antenna1
3 Service station list.....1	7 FM indoor antenna.....1
4 Remote control unit (RC-896).....1	

4 	5 	6 	7 
---	---	--	---

1 BEFORE USING

Pay attention to the following before using this unit:

- **Moving the set**

To prevent short circuits or damaged wires in the connection cords, always unplug the power cord and disconnect the connection cords between all other audio components when moving the set.

- **Before turning the power operation switch on**

Check once again that all connections are proper and that there are not problems with the connection cords. Always set the power operation switch to the standby position before connecting and disconnecting connection cords.

- **Store this instructions in a safe place.**

After reading, store this instructions along with the warranty in a safe place.

- **Note that the illustrations in this instructions may differ from the actual set for explanation purposes.**

- **V. AUX terminal**

The AVR-1403/483's front panel is equipped with a V. AUX terminal. Remove the cap covering the terminal when you want to use it.

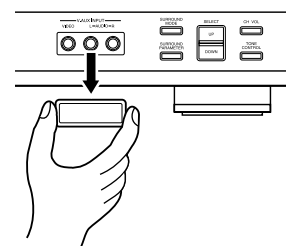

2 CAUTIONS ON INSTALLATION

Noise or disturbance of the picture may be generated if this unit or any other electronic equipment using microprocessors is used near a tuner or TV.

If this happens, take the following steps:

- Install this unit as far as possible from the tuner or TV.
- Set the antenna wires from the tuner or TV away from this unit's power cord and input/output connection cords.
- Noise or disturbance tends to occur particularly when using indoor antennas or 300 Ω /ohms feeder wires. **We recommend using outdoor antennas and 75 Ω /ohms coaxial cables.**

For heat dispersal, leave at least 0.3 ft (10 cm) of space between the top, back and sides of this unit and the wall or other components.

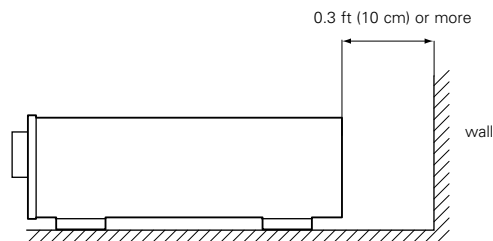
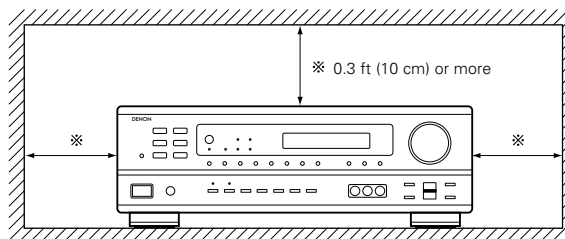

3 CAUTIONS ON HANDLING

- **Switching the input function when input jacks are not connected**

A clicking noise may be produced if the input function is switched when nothing is connected to the input jacks. If this happens, either turn down the MASTER VOLUME control or connect components to the input jacks.

- **Muting of PRE OUT jack, HEADPHONE jack and SPEAKER terminals**

The PRE OUT jack, HEADPHONE jack and SPEAKER terminals include a muting circuit. Because of this, the output signals are greatly reduced for several seconds after the power operation switch is turned on or input function, surround mode or any other set-up is changed.

If the volume is turned up during this time, the output will be very high after the muting circuit stops functioning. Always wait until the muting circuit turns off before adjusting the volume.

- **Whenever the power operation switch is in the STANDBY state, the apparatus is still connected on some AC line voltages. Please be sure to unplug the cord when you leave home for, say, a vacation.**

4 FEATURES

1. Dolby Pro Logic II decoder

Dolby Pro Logic II is a new format for playing multichannel audio signals that offers improvements over conventional Dolby Pro Logic. It can be used to decode not only sources recorded in Dolby Surround but also regular stereo sources into five channels (front left/right, center and surround left/right). In addition, various parameters can be set according to the type of source and the contents, so you can adjust the sound field with greater precision.

2. Dolby Digital decoder

Dolby Digital, a digital discrete system in which the different channels are completely independent, recreates "three-dimensional" sound fields (sounds with a sense of distance, movement and position) with no crosstalk between channels for greater reality. In addition, the 5 channels (excluding the 0.1 channel for low frequency effects) have a playback range extending to 20 kHz, the same as the range of CDs, thus resulting in clearer, more richly expressive sound.

3. DTS (Digital Theater Systems)

DTS provides up to 5.1 channels of wide-range, high fidelity surround sound, from sources such as laser disc, DVD and specially-encoded music discs.

4. High performance DSP simulates 7 sound fields

Playback is possible in 7 surround modes: 5-channel Stereo, Mono Movie, Rock Arena, Jazz Club, Video Game, Matrix and Virtual. You can enjoy a variety of sound effects for different movie scenes and program sources even with stereo sources not in Dolby Surround.

5. Personal Memory Plus function

Personal Memory Plus is an advanced version of Personal Memory. With Personal Memory Plus, the set automatically memorizes the surround mode, channel volume, surround parameters, etc., for each of the separate input sources.

6. Remote control unit with pre-memory function

This unit comes with a remote control unit equipped with a pre-memory function. The remote control command codes for DENON remote controllable AV components as well as for LD players, video decks, TVs, etc., of other major manufacturers are pre-stored in the memory.

7. 6CH EXT. IN jack

This unit is equipped with 6CH EXT. IN jacks for use with audio formats of the future.

5 PART NAMES AND FUNCTIONS

Front Panel

• For details on the functions of these parts, refer to the pages given in parentheses ().

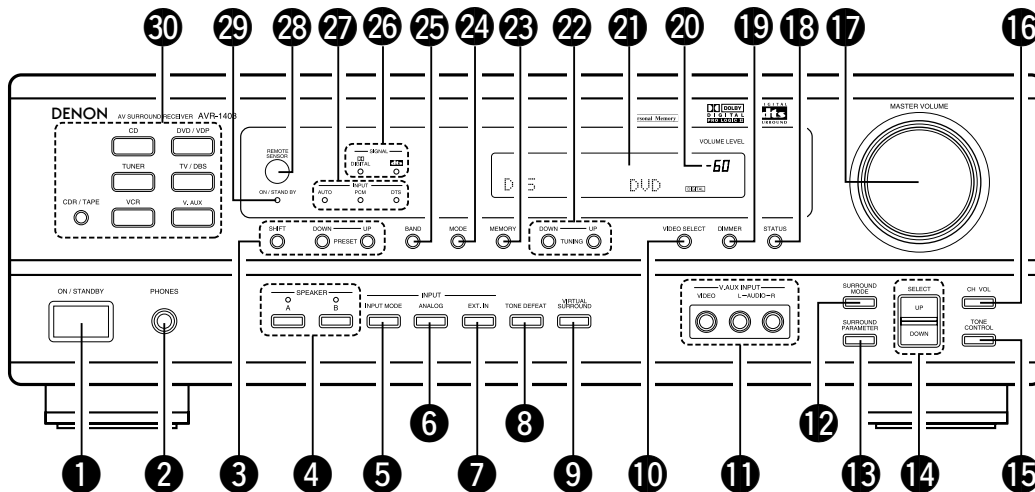

- | | |
|--|--|
| 1 Power operation switch(17, 24, 39) | 16 CH VOL button(29) |
| 2 Headphones jack (PHONES).....(27) | 17 MASTER VOLUME control.....(26) |
| 3 Preset station selector buttons(41) | 18 STATUS button(27) |
| 4 SPEAKER A/B buttons.....(24, 27, 42) | 19 DIMMER button(27) |
| 5 INPUT MODE button.....(25, 28, 32) | 20 Master volume indicator (VOLUME LEVEL).....(26) |
| 6 ANALOG button(25, 28) | 21 Display |
| 7 EXT. IN button(25, 28) | 22 TUNING UP/DOWN button(40) |
| 8 TONE DEFEAT button(26) | 23 MEMORY button.....(39, 41) |
| 9 VIRTUAL SURROUND button(34, 35, 37) | 24 MODE button(40) |
| 10 VIDEO SELECT button(27) | 25 BAND button(40) |
| 11 V. AUX INPUT jacks(4, 11) | 26 SIGNAL indicators.....(26) |
| 12 SURROUND MODE button.....(26, 30, 32, 37) | 27 INPUT mode indicators.....(26) |
| 13 SURROUND PARAMETER button.....(37) | 28 Remote control sensor (REMOTE SENSOR)(15) |
| 14 SELECT UP/DOWN button(26, 29, 30, 32, 37) | 29 Power operation indicator |
| 15 TONE CONTROL button.....(26) | 30 Input source selector buttons(25, 32) |

Remote control unit

- For details on the functions of these parts, refer to the pages given in parentheses ().

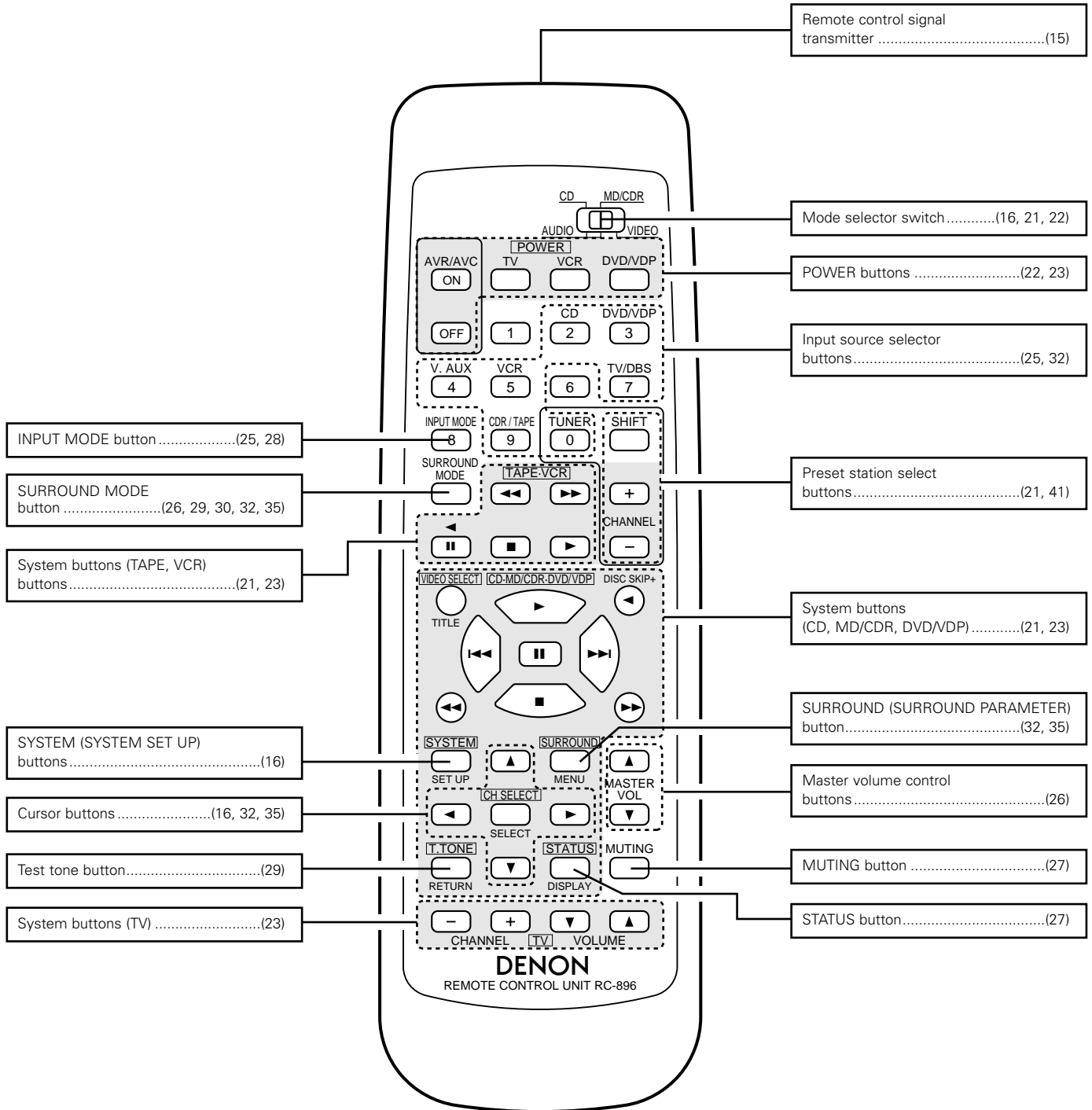

6 READ THIS FIRST

This AV Surround Receiver must be setup before use. Following these steps.

Step 1 (page 8 to 14)

Choose the best location to setup the Speakers and connecting the components.

Step 2 (page 15)

Next, insert the batteries into the remote control unit.

Step 3 (page 16 to 20)

Finally, setting up the system.

7 SETTING UP THE SPEAKER SYSTEMS

■ Speaker system layout

Basic system layout

- The following is an example of the basic layout for a system consisting of six speaker systems and a television monitor:

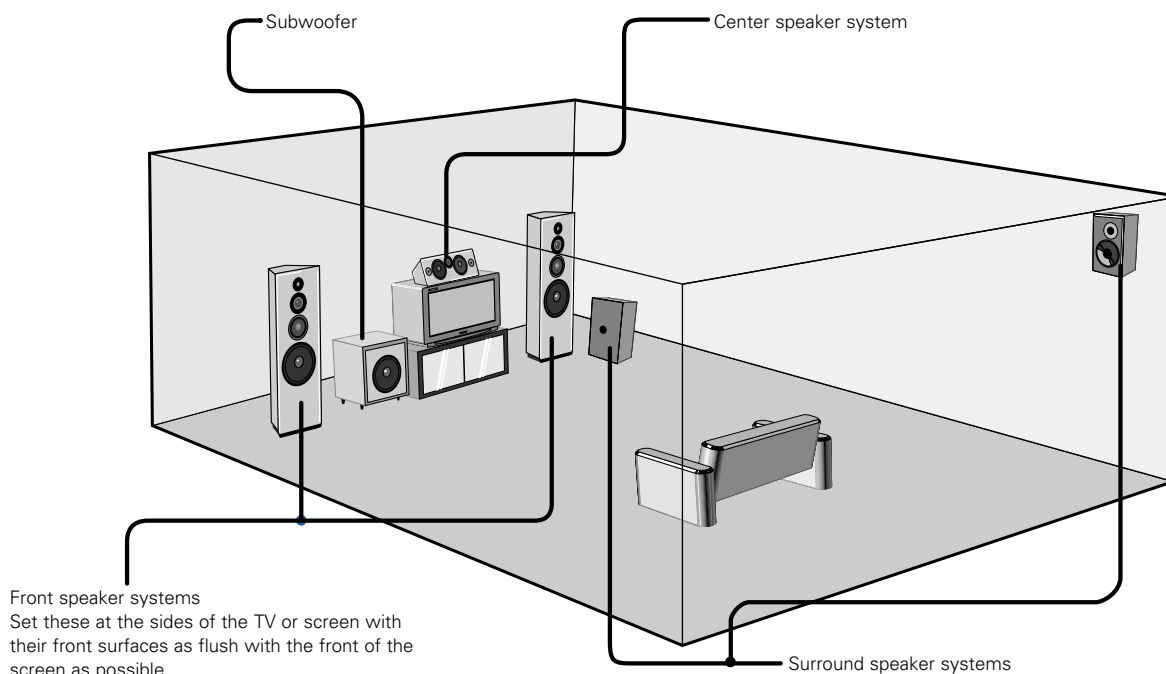

8 CONNECTIONS

- Do not plug in the power cord until all connections have been completed.
- Be sure to connect the left and right channels properly (left with left, right with right).
- Insert the plugs securely. Incomplete connections will result in the generation of noise.
- **Use the AC OUTLET for audio equipment only. Do not use it for hair driers, etc.**
- Note that binding pin plug cords together with power cords or placing them near a power transformer will result in generating hum or other noise.
- Noise or humming may be generated if a connected audio equipment is used independently without turning the power of this unit on. If this happens, turn on the power of the this unit.

Connecting the audio components

Decoders with 6-channel analog outputs, etc.

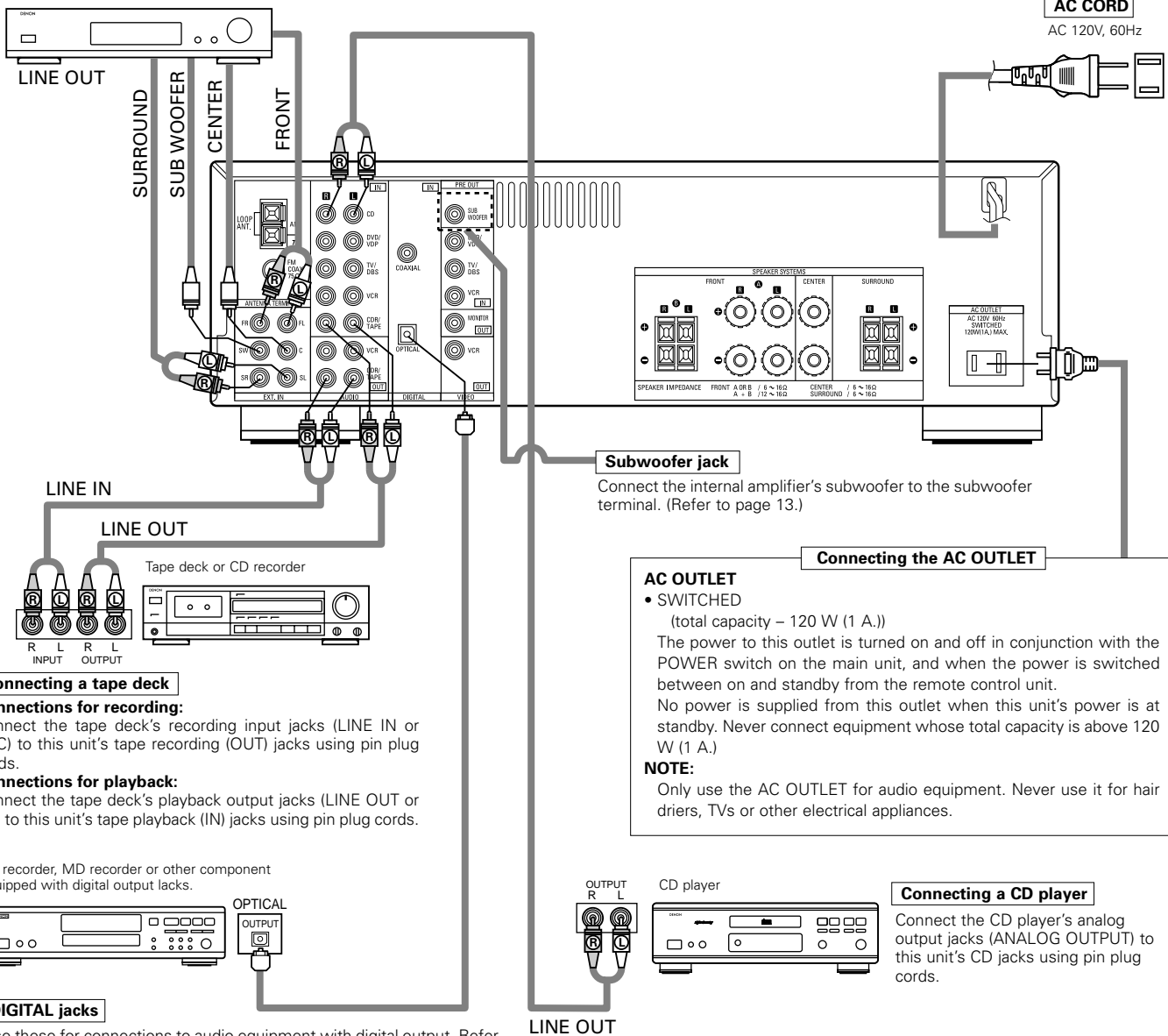

- Use 75 Ω /ohms cable pin cords (sold separately) for coaxial connections.
- Use optical cables (sold separately) for optical connections.

Connecting the video equipments

To connect the video signal, connect using a 75 Ω/ohms video signal cable cord. Using an improper cable can result in a drop in sound quality.

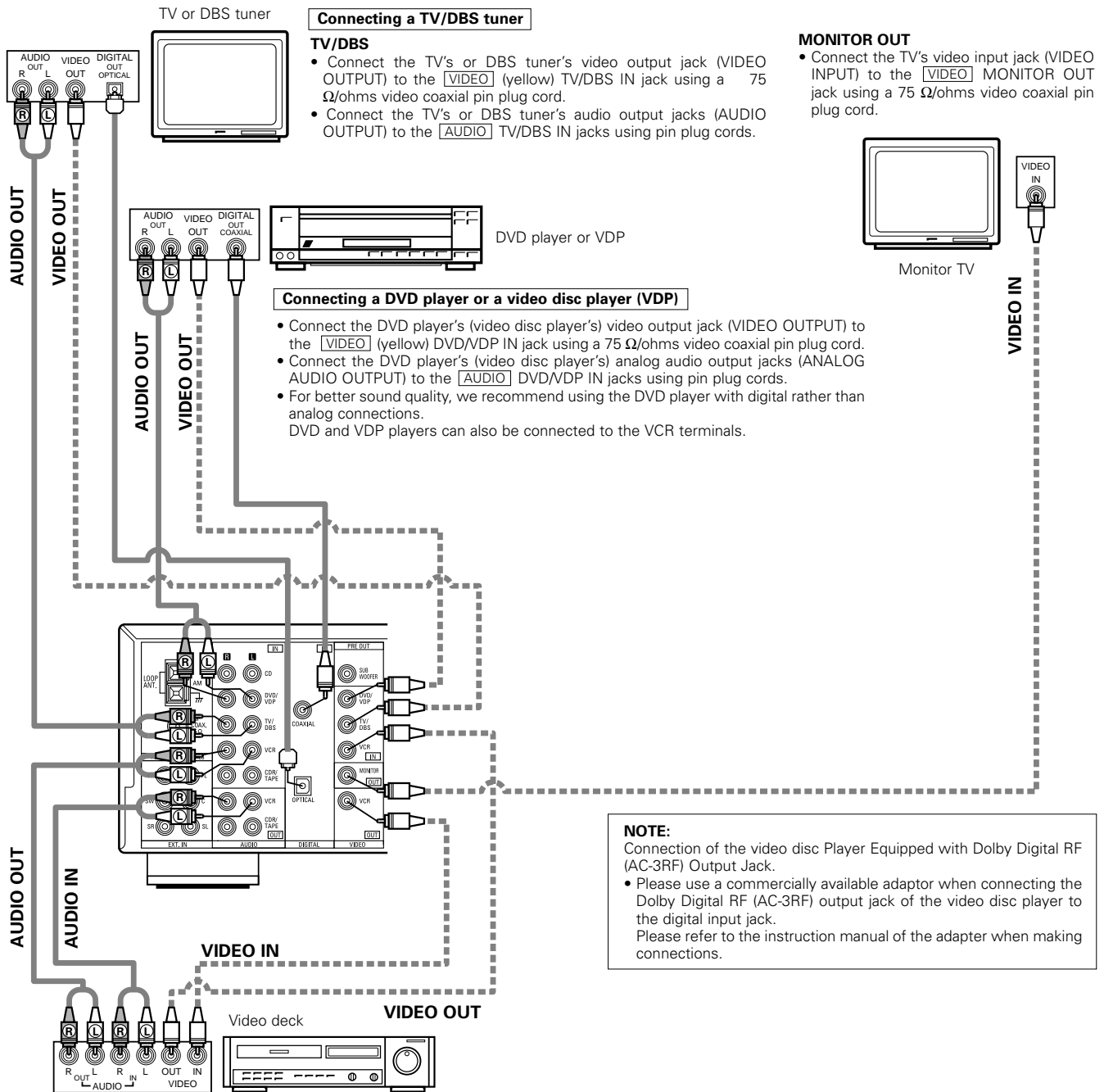

Connecting a video decks

Video input/output connections:

- Connect the video deck's video output jack (VIDEO OUT) to the [VIDEO] (yellow) VCR IN jack, and the video deck's video input jack (VIDEO IN) to the [VIDEO] (yellow) VCR OUT jack using 75 Ω/ohms video coaxial pin plug cords.

Connecting the audio output jacks:

- Connect the video deck's audio output jacks (AUDIO OUT) to the [AUDIO] VCR IN jacks, and the video deck's audio input jacks (AUDIO IN) to the [AUDIO] VCR OUT jacks using pin plug cords.

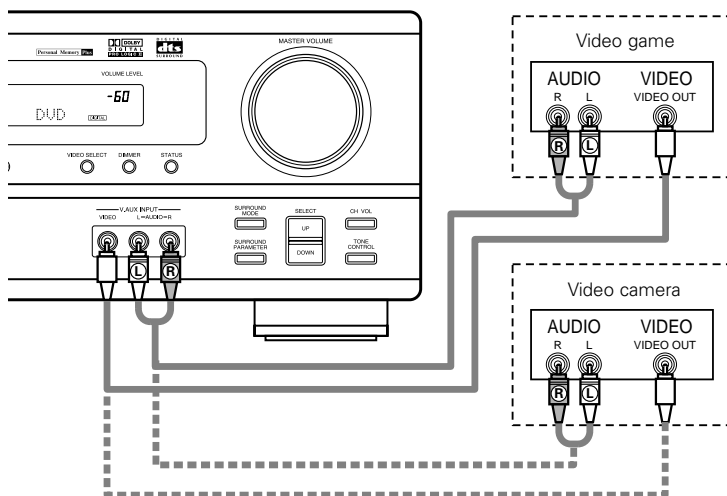

Connecting a Video game equipment

- Connect the Video game equipment's output jacks to this unit's V. AUX INPUT jacks.

Connecting a Video camera equipment

- Connect the video camera equipment's output jacks to this unit's V. AUX INPUT jacks.

※ The V. AUX terminal is covered with a cap. Remove this cap in order to use the terminal. (See page 4 for instructions on removing the cap.)

Connecting the antenna terminals

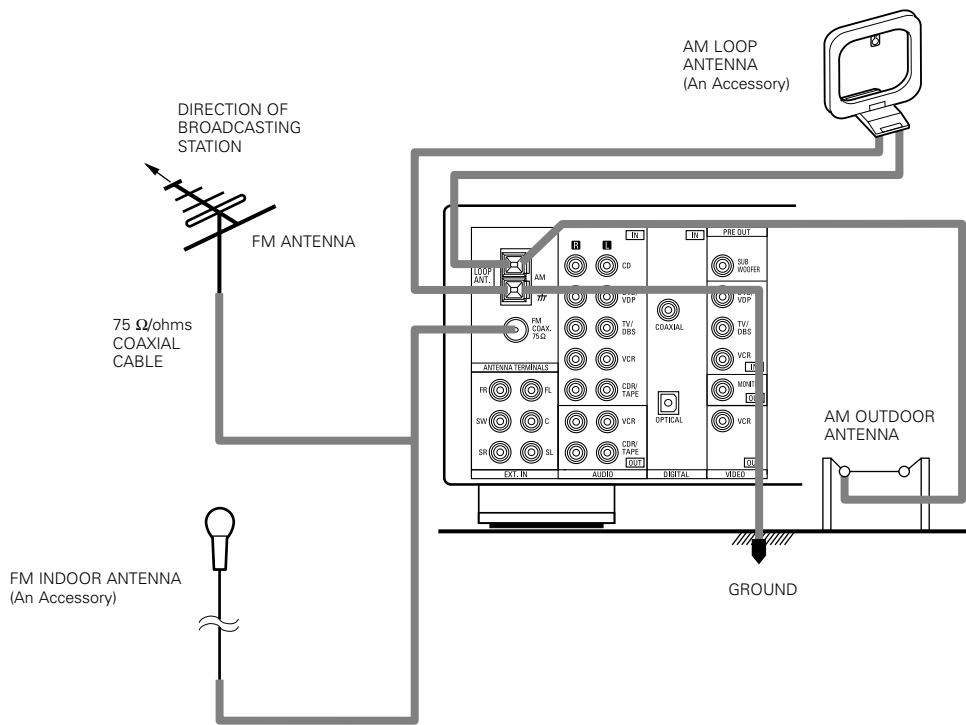

AM loop antenna assembly

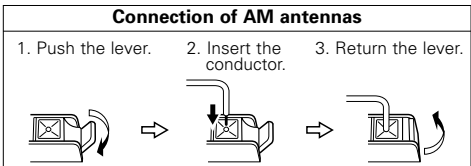
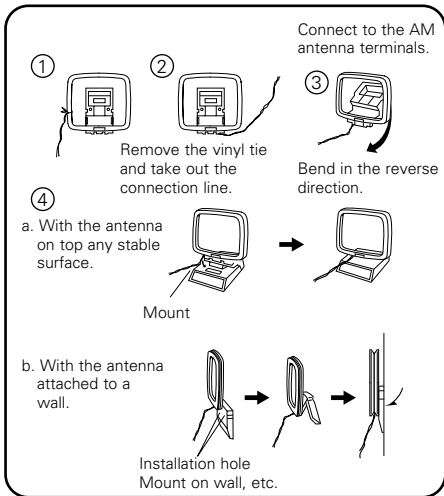

Note to CATV system installer:
 This reminder is provided to call the CATV system installer's attention to Article 820-40 of the NEC which provides guidelines for proper grounding and, in particular, specifies that the cable ground shall be connected to the grounding system of the building, as close to the point of cable entry as practical.

- Notes:**
- Do not connect two FM antennas simultaneously.
 - Even if an external AM antenna is used, do not disconnect the AM loop antenna.
 - Make sure AM loop antenna lead terminals do not touch metal parts of the panel.

Speaker system connections

- Connect the speaker terminals with the speakers making sure that like polarities are matched (⊕ with ⊕, ⊖ with ⊖). Mismatching of polarities will result in weak central sound, unclear orientation of the various instruments, and the sense of direction of the stereo being impaired.
- When making connections, take care that none of the individual conductors of the speaker cord come in contact with adjacent terminals, with other speaker cord conductors, or with the rear panel.

NOTE:

- **NEVER touch the speaker terminals when the power is on. Doing so could result in electric shocks.**
- **Do not use speaker cords with a diameter of over 1.5 mm. Doing so may damage the speaker terminals. (for FRONT SPEAKER B, SURROUND SPEAKER)**

Speaker Impedance

- When speaker systems A and B are use separately, speakers with an impedance of 6 to 16 Ω/ohms can be connected for use as front speakers.
- Be careful when using two pairs of front speakers (A + B) at the same time, since use of speakers with an impedance of 12 to 16 Ω/ohms.
- Speakers with an impedance of 6 to 16 Ω/ohms can be connected for use as center and surround speakers.
- The protector circuit may be activated if the set is played for long periods of time at high volumes when speakers with an impedance lower than the specified impedance are connected.

Connecting the speaker cords

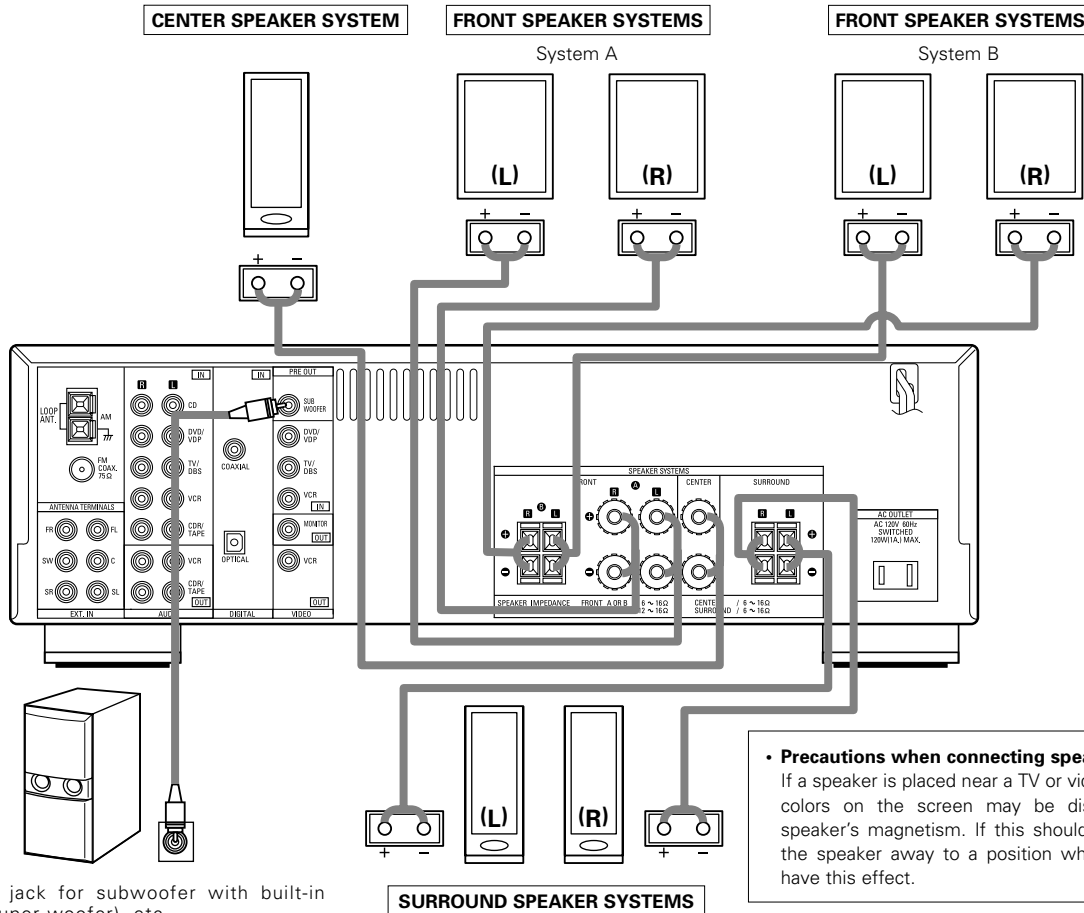
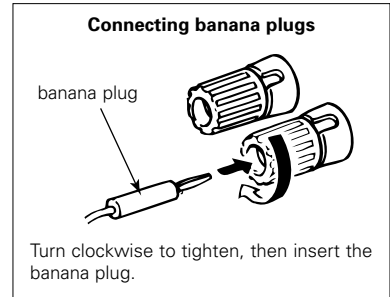
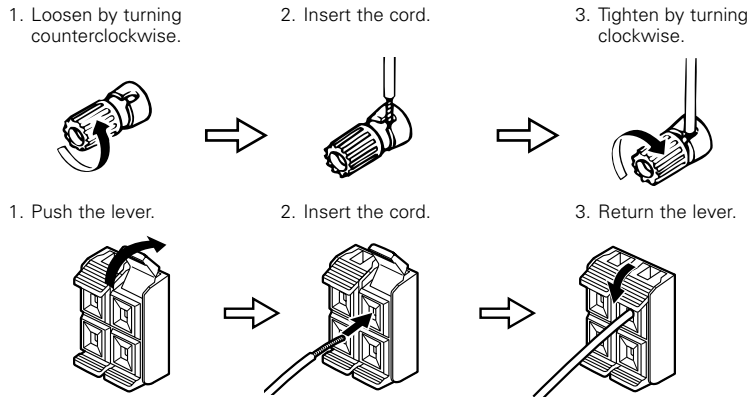

• Precautions when connecting speakers
 If a speaker is placed near a TV or video monitor, the colors on the screen may be disturbed by the speaker's magnetism. If this should happen, move the speaker away to a position where it does not have this effect.

Connection jack for subwoofer with built-in amplifier (super woofer), etc.
 ※ To achieve Dolby Digital (AC-3) playback effect, use a unit that can sufficiently reproduce frequencies of under 80 Hz.

Protector circuit

- This unit is equipped with a high-speed protection circuit. The purpose of this circuit is to protect the speakers under circumstances such as when the output of the power amplifier is inadvertently short-circuited and a large current flows, when the temperature surrounding the unit becomes unusually high, or when the unit is used at high output over a long period which results in an extreme temperature rise.

When the protection circuit is activated, the speaker output is cut off and the power supply indicator LED flashes. Should this occur, please follow these steps: be sure to switch off the power of this unit, check whether there are any faults with the wiring of the speaker cables or input cables, and wait for the unit to cool down if it is very hot. Improve the ventilation condition around the unit and switch the power back on.

If the protection circuit is activated again even though there are no problems with the wiring or the ventilation around the unit, switch off the power and contact a DENON service center.

Note on speaker impedance

- The protector circuit may be activated if the set is played for long periods of time at high volumes when speakers with an impedance lower than the specified impedance (for example speakers with an impedance of lower than 4 Ω /ohms) are connected. If the protector circuit is activated, the speaker output is cut off. Turn off the set's power, wait for the set to cool down, improve the ventilation around the set, then turn the power back on.

9 USING THE REMOTE CONTROL UNIT

Following the procedure outlined below, insert the batteries before using the remote control unit.

Range of operation of the remote control unit

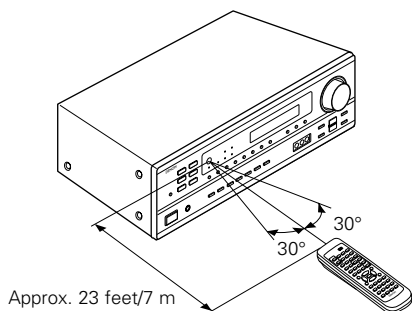

Point the remote control unit at the remote control sensor as shown on the diagram at the left.

NOTES:

- The remote control unit can be used from a straight distance of approximately 23 feet/7 meters, but this distance will shorten or operation will become difficult if there are obstacles between the remote control unit and the remote control sensor, if the remote control sensor is exposed to direct sunlight or other strong light, or if operated from an angle.
- Neon signs or other devices emitting pulse-type noise nearby may result in malfunction, so keep the set as far away from such devices as possible.

Inserting the batteries

- ① Press as shown by the arrow and slide off.

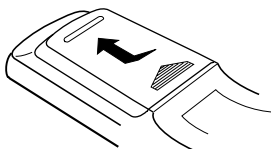

- ② Insert the R6P/AA batteries properly, as shown on the diagram.

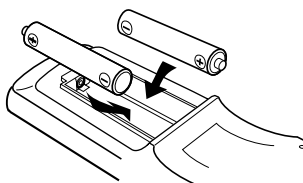

- ③ Close the lid.

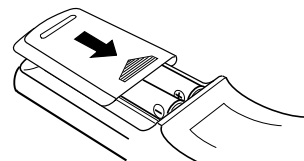

NOTES:

- Use only R6P/AA batteries for replacement.
- Be sure the polarities are correct. (See the illustration inside the battery compartment.)
- Remove the batteries if the remote control transmitter will not be used for an extended period of time.
- If batteries leak, dispose of them immediately. Avoid touching the leaked material or letting it come in contact with clothing, etc. Clean the battery compartment thoroughly before installing new batteries.
- Have replacement batteries on hand so that the old batteries can be replaced as quickly as possible when the time comes.
- Even if less than a year has passed, replace the batteries with new ones if the set does not operate even when the remote control unit is operated nearby the set. (The included battery is only for verifying operation. Replace it with a new battery as soon as possible.)

10 SETTING UP THE SYSTEM

- Once all connections with other AV components have been completed as described in "CONNECTIONS" (see pages 9 to 14), make the various settings described below on the display. These settings are required to set up the listening room's AV system centered around the this unit.

1 Set the slide switch to "AUDIO".

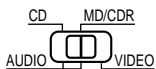

2 Use the following buttons to set up the system:

A diagram of a remote control with three callout boxes:

- SYSTEM SETUP button**: Press this to display the system setup on the display.
- CURSOR buttons (▲, ▼, ◀, ▶)**: Press this change what appears on the display.
- SELECT button**: Press this to switch the display. Also use this button to complete the setting.

- System setup items and default values (set upon shipment from the factory)

System setup		Default settings			
Speaker Configuration	Input the combination of speakers in your system and their corresponding sizes (SMALL for regular speakers, LARGE for full-size, full-range) to automatically set the composition of the signals output from the speakers and the frequency response.	Front Sp.	Center Sp.	Surround Sp.	Sub Woofer
		Large	Small	Small	Yes
Subwoofer Mode	This selects the subwoofer speaker for playing deep bass signals.	Subwoofer mode = Normal			
Delay Time	This parameter is for optimizing the timing with which the audio signals are produced from the speakers and subwoofer according to the listening position.	Front & Subwoofer	Center	Surround L & R	—
		12 ft (3.6 m)	12 ft (3.6 m)	10 ft (3.0 m)	—
Digital Input	This assigns the digital input jacks for the different input sources.	Digital Inputs	COAXIAL	OPTICAL	
		Input source	DVD/VDP	TV/DBS	

NOTE:

- The system setup is not displayed when "HEADPHONE ONLY" is selected.

Before setting up the system

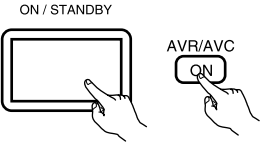

1  Check that all the components are correct, then press the POWER operation switch on the main unit or the POWER button on the remote control unit to turn on the power.

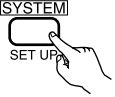
(Main unit) (Remote control unit)

2  Press the SYSTEM button to enter the setting.

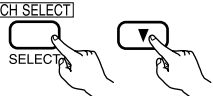

*SYSTEM SET UP

NOTE: Please make sure the "AUDIO" position of the slide switch on the remote control unit.

3  Press the SELECT or  (down) button to switch to the speaker configuration set up.

NOTE:
Press the SYSTEM button again to finish system set up. System set up can be finished at any time. The changes to the settings made up to that point are entered.

Setting the speaker configuration

1  Use the  (left) and  (right) buttons to select your front speaker type.

1 FRONT LARGE

(Initial)

LARGE







(left) button

SMALL



(right) button

Press the SELECT or  (down) button to switch to the center speaker setting.

2  Use the  (left) and  (right) buttons to select your center speaker type.

2 CENTER SMALL

(Initial)

LARGE



(left) button

SMALL





(right) button

NONE

Press the SELECT or  (down) button to switch to the surround speaker setting.

NOTE:
• When "Small" has been selected for the front speakers, "Large" cannot be selected for the center speaker.

3  Use the  (left) and  (right) buttons to select your surround speaker type.

3 SURR. SMALL

(Initial)

LARGE



(left) button

SMALL



(right) button

NONE

Press the SELECT or  (down) button to switch to the subwoofer setting.

NOTE:

- When "Small" has been selected for the front speakers, "Large" cannot be selected for the surround speakers.

4

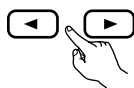

Use the ◀ (left) and ▶ (right) buttons to select your subwoofer setting.

4 S.WOOFER YES

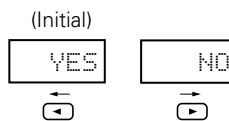

(Initial)
(left) button (right) button

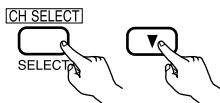

Press the SELECT or ▼ (down) button to enter the settings and switch to the SUBWOOFER MODE setting.

• **Parameters**

- Large..... Select this when using speakers that can fully reproduce low sounds of below 80 Hz.
- Small..... Select this when using speakers that cannot reproduce low sounds of below 80 Hz with sufficient volume. When this setting is selected, low frequencies of below 80 Hz are assigned to the subwoofer.
- None..... Select this when no speakers are installed.
- Yes/No.... Select "Yes" when a subwoofer is installed, "No" when it's not installed.

NOTE:

Select "Large" or "Small" not according to the physical size of the speaker, but according to the bass reproduction capacity at 80 Hz. If you cannot determine the best setting, try comparing the sound when set to "Small" and when set to "Large", at a level that will not damage the speakers.

Caution:

In case the subwoofer is not used, be sure to set "Subwoofer = No", or the bass sound of front channel is divided to subwoofer channel and not reproduced in some mode.

Setting the SUBWOOFER MODE

1

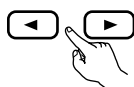

Use the ◀ (left) and ▶ (right) buttons to select the Subwoofer mode.

5 SW MODE NORM

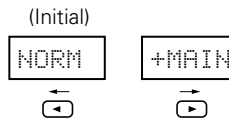

(Initial)
(left) button (right) button

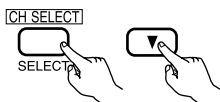

Press the SELECT or ▼ (down) button to enter the setting and switch to the SPEAKER DISTANCE setting.

NOTES:

— Assignment of low frequency signal range —

- The signals produced from the subwoofer channel are LFE signals (during playback of Dolby Digital or DTS signals) and the low frequency signal range of channels set to "SMALL" in the setup. The low frequency signal range of channels set to "LARGE" are produced from those channels.

— Subwoofer mode —

- The subwoofer mode setting is only valid when "LARGE" is set for the front speakers and "YES" is set for the subwoofer in the "Speaker Configuration" settings (see pages 17, 18).
If "SMALL" is set for the front speakers or "NO" is set for the subwoofer, the subwoofer mode setting does not affect playback of low frequency signal range.
- When the "+MAIN" playback mode is selected, the low frequency signal range of channels set to "LARGE" are produced simultaneously from those channels and the subwoofer channel.
In this playback mode, the low frequency range expand more uniformly through the room, but depending on the size and shape of the room, interference may result in a decrease of the actual volume of the low frequency range.
- When the "NORM" playback mode is selected, the low frequency signal range of channels set to "LARGE" are only produced from those channels. In this playback mode there tends to be little interference of the low frequency range in the room.
- Try playing the music or movie source and select the playback mode providing the stronger low frequency range sound.

Setting the speaker distance

Input the distances from the listening position to the speakers and set the surround delay time.

Preparations:

Measure the distances from the listening position to the speakers (L1 to L3 on the diagram at the right).

- L1: Distance from center speaker to listening position
- L2: Distance from front speakers to listening position
- L3: Distance from surround speaker to listening position

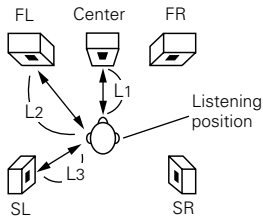

CAUTION:

- ※ Set the center speaker at the same distance from the front speakers (left and right) or the subwoofer, or so that the difference in distance (L2 – L1) is 5 feet or less.
- ※ Set the surround speakers (left and right) at the same distance from the front speakers (left and right) or the subwoofer, or so that the difference in distance (L2 – L3) is 15 feet or less.

1 Use the ◀ (left) and ▶ (right) buttons to set the distance from the front speakers and subwoofer to the listening position.

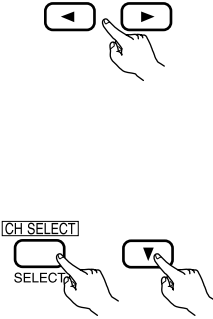

6 FRNT/SW 12ft

- The number changes in units of 1 foot each time one of the buttons is pressed. Select the value closest to the measured distance. (“/SW” appears only when subwoofer = yes.)

Press the SELECT or ▼ (down) button to switch to the center speaker setting.

NOTE:

- The speaker distance can be adjusted between 0 and 60 feet in steps of 1 foot.

2 Use the ◀ (left) and ▶ (right) buttons to set the distance from the center speakers to the listening position.

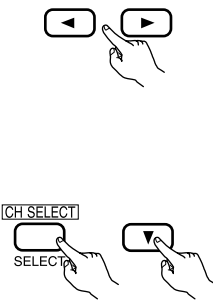

7 CENTER 12ft

- The number changes in units of 1 foot each time one of the buttons is pressed. Select the value closest to the measured distance.

Press the SELECT or ▼ (down) button to switch to the surround speaker setting.

NOTE:

- No setting when “None” has been selected for the center speaker.

3 Use the ◀ (left) and ▶ (right) buttons to set the distance from the surround speakers to the listening position.

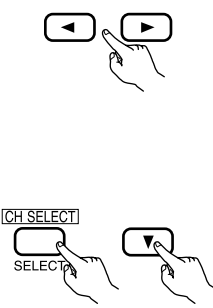

8 SURR. 10ft

- The number changes in units of 1 foot each time one of the buttons is pressed. Select the value closest to the measured distance.



Press the SELECT or ▼ (down) button to enter the setting and switch the DIGITAL input (COAX) setting.

NOTE:

- No setting when “None” has been selected for the surround speakers.

Digital input setup

Input the type of components connected to the digital input terminals.

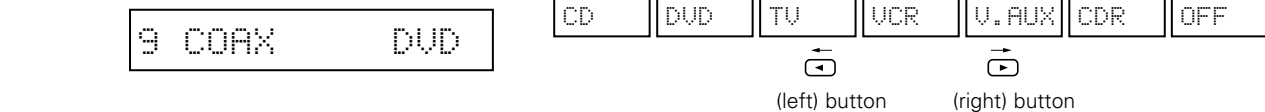

- 1** Use the  (left) and  (right) buttons to set the type of device connected to the COAXIAL input (COAXIAL) terminal.

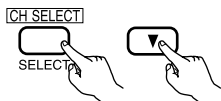

- Select "OFF" if nothing is connected.



Press the SELECT or  (down) button to switch the optical input (OPT) setting.

- 2** Use the  (left) and  (right) buttons to set the type of device connected to the OPTICAL input (OPTICAL) terminal.

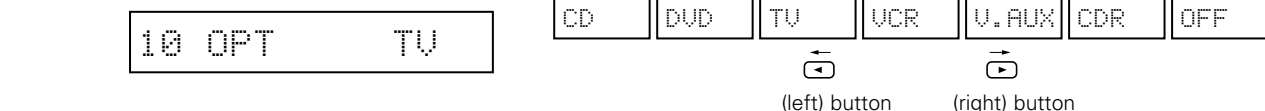

- Select "OFF" if nothing is connected.

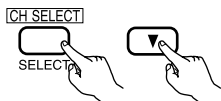

Press the SELECT or  (down) button if you want to start the settings over from the beginning.

NOTE:

- TUNER cannot be selected.

After setting up the system

- 1** Press the SYSTEM button to finish system set up.

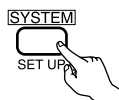

This completes the system setup operations. Once the system is set up, there is no need to make the settings again unless other components or speakers are connected to or the speaker layout is changed.

11 REMOTE CONTROL UNIT

Operating DENON audio components

DENON remote-controllable audio components can be controlled using this unit's remote control unit. Note that some components, however, cannot be operated with this remote control unit.

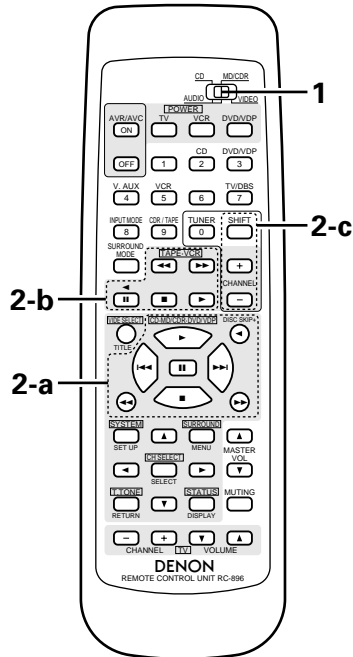

1 Set the slide switch to the position for the component to be operated (CD or MD/CDR).

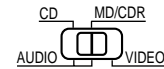

2 Use the buttons shown below to operate the audio component. For details, refer to the respective component's manual.

a. For CD player and MD/CD recorder

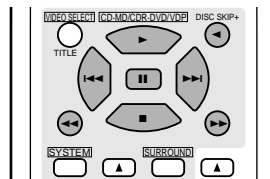

- ◀▶ : Manual search (reverse and forward)
- : Stop
- ▶ : Play
- ◀▶▶▶ : Auto search
- ⏸ : Pause
- DISC SKIP+ : Switch discs (for CD changers only)

b. For tape deck (TAPE)

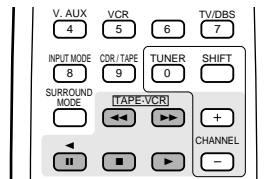

- ◀◀ : Rewind
- ▶▶ : Fast-forward
- : Stop
- ▶ : Forward play
- ◀ : Reverse play

c. For TUNER

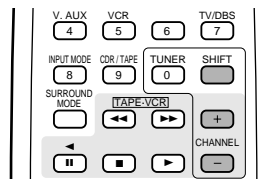

- SHIFT : Switch preset channel range
- CHANNEL : Preset channel up/down (+, -)

NOTE:

- Tape deck (TAPE) and tuner can be operated when the switch is at "AUDIO" position.

Preset memory (Audio component)

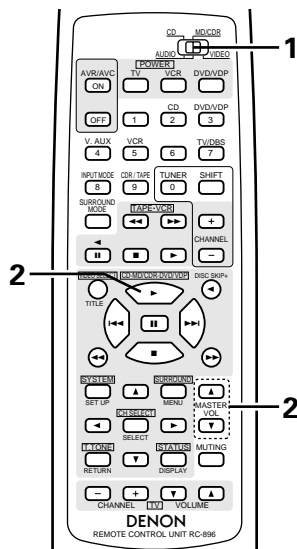

DENON components can be operated by setting the preset memory for MD or CDR. Operation is not possible for some models.

1 Set the slide switch to "MD/CDR".

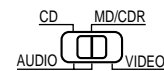

2 Holding in the PLAY (▶) button, press the button for the components you want to set. (Refer to table 1.)

Table 1: Combinations of Personal System Codes

	MASTER VOL. (▲)	MASTER VOL. (▼)
PLAY (▶)	MD	CDR

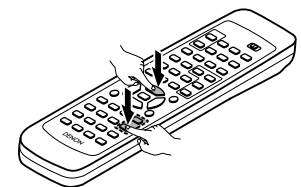

NOTE:

- The memory can only be preset for either the MD or the CDR.
- ※ [] Preset codes set upon shipment from the factory and when reset.

Preset memory (Video component)

DENON and other makes of components can be operated by setting the preset memory for your make of video component. This remote control unit can be used to operate components of other manufacturers without using the learning function by registering the manufacturer of the component as shown on the List of Preset Codes (pages 92, 93). Operation is not possible for some models.

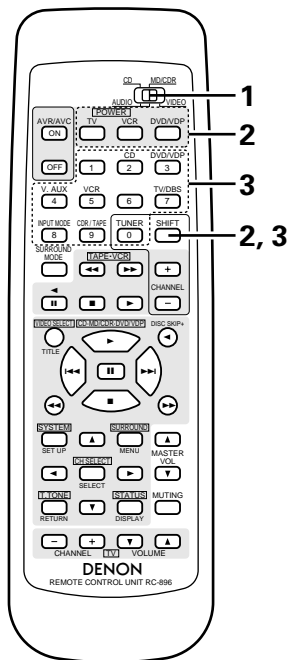

1 Set the slide switch to "VIDEO".

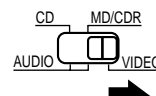

2 Holding in the SHIFT button ①, press the POWER button ② of the components (DVD/VP, VCR or TV) you want to set.

※ Press and hold in the SHIFT button.

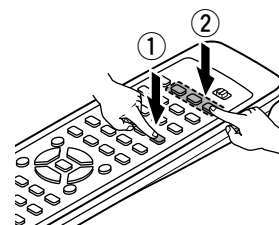

3 Holding in the SHIFT button ①, press the number buttons ② to input the preset code (consisting of 2-digit numbers) for the manufacturer of the component whose signals you want to store in the memory.

See the list on pages 92 and 93 for the preset codes (consisting of 2-digit numbers).

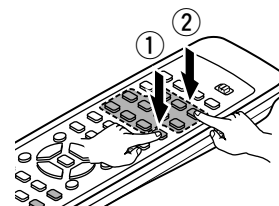

4 To continue registering other components, repeat steps 2 to 3.

NOTES:

- The signals for the pressed buttons are emitted while setting the preset memory. To avoid accidental operation, cover the remote control unit's transmitting window while setting the preset memory.
- Some models and years of manufacture of components of the manufacturers listed on the List of Preset Codes cannot be used.
- The unit is equipped with several types of remote control codes which depend on the manufacturer. If there is no operation, please change the preset code (a 2-digit number) and try again.

Operating a video component stored in the preset memory

1 Set the slide switch to "VIDEO".

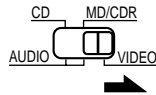

2 Operate the video component.

- For details, refer to the component's operating instructions.
- For details, refer to the List of Preset Codes (pages 92, 93).
- ※ Some models cannot be operated with this remote control unit.

a. For DVD player

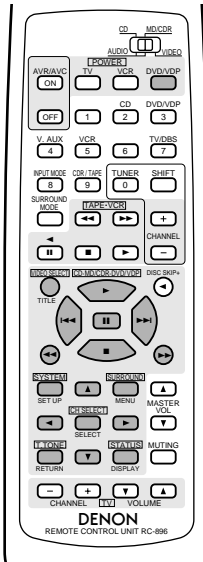

- POWER : Turns power on and off
- : Stop
- ▶ : Play
- ◀◀▶▶ : Auto search (cue)
- ◀◀▶▶ : Manual search (reverse and forward)
- || : Pause
- TITLE : Call out title
- MENU : Call out menu
- DISPLAY : Switch display
- SET UP : DVD setup
- RETURN : Menu return
- ▲, ▼ : Cursor up/down
- ◀, ▶ : Cursor left/right
- SELECT : Enter setting

NOTE:
Some manufacturers use different names for the DVD remote control buttons, so also refer to the instructions on remote control for that component.

b. For video disc player (VDP)

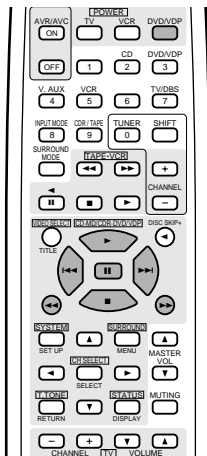

- POWER : Power on/off
- ◀◀▶▶ : Manual search (forward and reverse)
- : Stop
- ▶ : Play
- ◀◀▶▶ : Auto search (cue)
- || : Pause

c. For video deck (VCR)

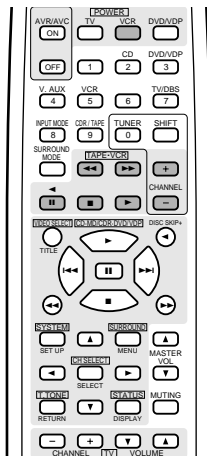

- POWER : Power on/off
- ◀◀▶▶ : Manual search (forward and reverse)
- : Stop
- ▶ : Play
- || : Pause
- CHANNEL : Switch channel (+, -)

d. For monitor TV

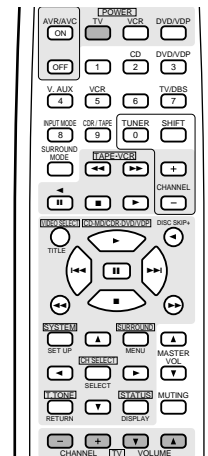

- POWER : Power on/off
- VOLUME : Volume up/down (▲, ▼)
- CHANNEL : Switch channel (+, -)

NOTE: • The TV can be operated when the switch is at any position.

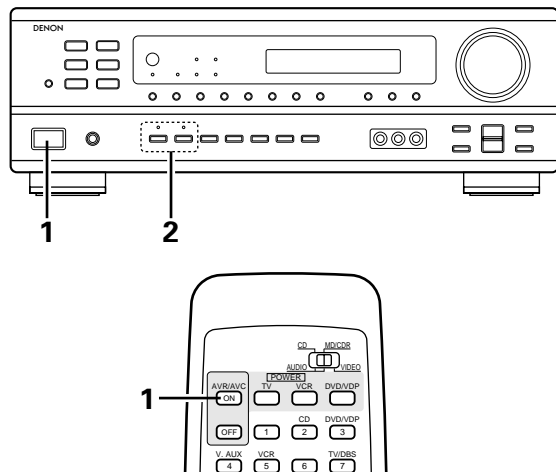
12 OPERATION**Before operating****Preparations:**

Check that all connections are proper.

1

Turn on the power.

Press the ON/STANDBY button on the main unit or AVR/AVC button on the remote control unit to turn on the power.

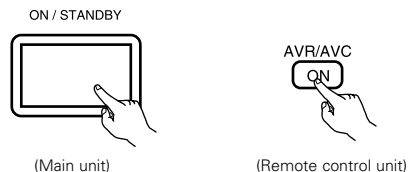

- ON/STANDBY

When the button is pressed, the power turns on and the display lights after approximately 1 second.

When pressed again, the power turns off, the standby mode is set and the display turns off.

Several seconds are required from the time the power operation switch is set to the "ON" position until sound is output. This is due to the built-in muting circuit that prevents noise when the power switch is turned on and off.

2

Select the front speakers.

Press the SPEAKER A or B button to turn the speaker on.

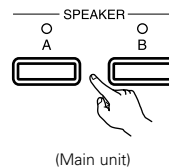

Playing the input source

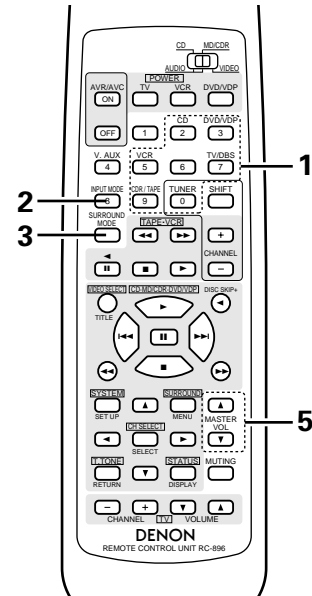
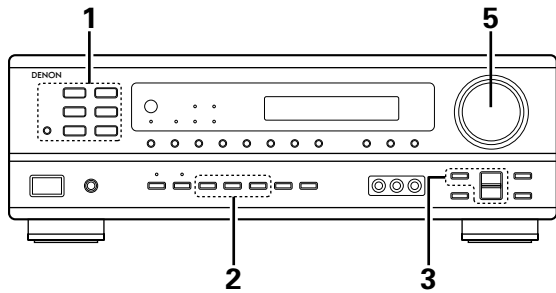

1 Press the button for the program source to be played.
EX 1: CD



EX 2: CDR/TAPE



2 Select the input mode.
To select the input mode from main unit.

- Selecting the analog mode
Press the ANALOG button to switch to the analog input.
- Selecting the external input (EXT. IN) mode.
(In this case play the component connected to the "EXT. IN" terminal.)
Press the EXT. IN button to switch the external input.
- Selecting the AUTO, PCM and DTS modes.
The mode switches as shown below each time the INPUT MODE button is pressed.

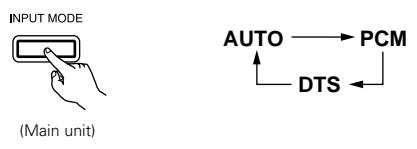
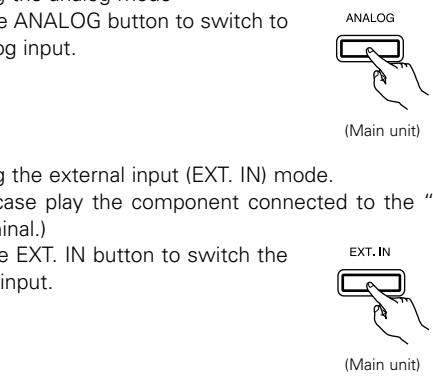

To select the input mode from the remote control unit.

- The mode switches as shown below each time the INPUT MODE button is pressed.

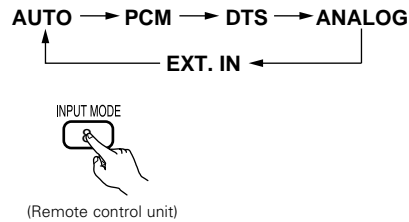

Input mode selection function

Different input modes can be selected for the different input sources. The selected input modes for the separate input sources are stored in the memory.

- ① **AUTO (All auto mode)**
In this mode, the types of signals being input to the digital and analog input jacks for the selected input source are detected and the program in the this unit's surround decoder is selected automatically upon playback. This mode can be selected for all input sources other than TUNER.
The presence or absence of digital signals is detected, the signals input to the digital input jacks are identified and decoding and playback are performed automatically in DTS, Dolby Digital or PCM (2 channel stereo) format. If no digital signal is being input, the analog input jacks are selected.
Use this mode to play Dolby Digital signals.
- ② **PCM (exclusive PCM signal playback mode)**
Decoding and playback are only performed when PCM signals are being input.
Note that noise may be generated when using this mode to play signals other than PCM signals.
- ③ **DTS (exclusive DTS signal playback mode)**
Decoding and playback are only performed when DTS signals are being input.
- ④ **ANALOG (exclusive analog audio signal playback mode)**
The signals input to the analog input jacks are decoded and played.
- ⑤ **EXT. IN (external decoder input jack selection mode)**
The signals being input to the external decoder input jacks are played without passing through the surround circuitry.

NOTE:

- Note that noise will be output when CDs or LDs recorded in DTS format are played in the "PCM" (exclusive PCM signal playback) or "ANALOG" (exclusive analog audio signal playback) mode. Select the AUTO or DTS (exclusive DTS signal playback) mode when playing signals recorded in DTS from a laser disc player.

Notes on playing a source encoded with DTS

- **Noise may be generated at the beginning of playback and while searching during DTS playback in the AUTO mode. If so, play in the DTS mode.**
- **In some rare cases noise may be generated when you preform the operation to stop playback of a DTS-CD or DTS-LD.**

- 3** Select the play mode.
Press the SURROUND MODE button, then press the SELECT button.

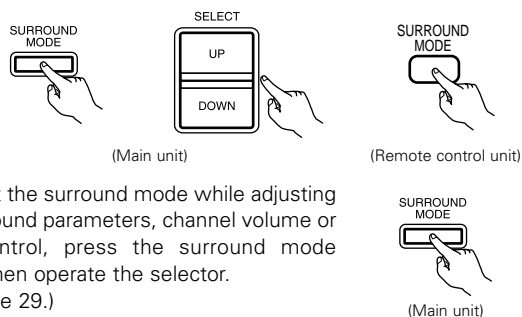

※ To select the surround mode while adjusting the surround parameters, channel volume or tone control, press the surround mode button then operate the selector.
(See page 29.)

- 4** Start playback on the selected component.
• For operating instructions, refer to the component's manual.

- 5** Adjust the volume.

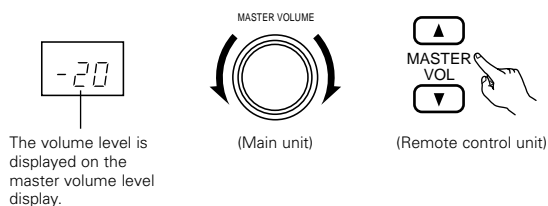

※ The volume can be adjusted within the range of -60 to 0 to 18 dB, in steps of 1 dB. However, when the channel level is set as described on page 29, if the volume for any channel is set at +1 dB or greater, the volume cannot be adjusted up to 18 dB. (In this case the maximum volume adjustment range is "18 dB — (Maximum value of channel level)".)

Input mode when playing DTS sources

- Noise will be output if DTS-compatible CDs or LDs are played in the "ANALOG" or "PCM" mode.
When playing DTS-compatible sources, be sure to connect the source component to the digital input jacks (OPTICAL/COAXIAL) and set the input mode to "DTS".

Input mode display

- In the AUTO mode
- In the DIGITAL PCM mode
- In the DIGITAL DTS mode
- In the ANALOG mode

One of these lights, depending on the input signal.



Input signal display

- DOLBY DIGITAL
- DTS
- PCM

※ The DIGITAL indicator lights when digital signals are being input properly. If the DIGITAL indicator does not light, check whether the digital input component setup (page 20) and connections are correct and whether the component's power is turned on.

NOTE:

- The DIGITAL indicator will light when playing CD-ROMs containing data other than audio signals, but no sound will be heard.

After starting playback

[1] Adjusting the sound quality (tone)

- 1** The tone switches as follows each time the TONE CONTROL button is pressed.

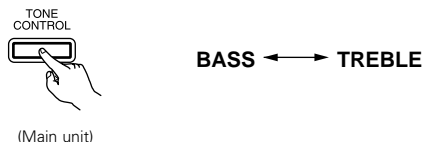

- 2** With the name of the volume to be adjusted selected, press the SELECT button to adjust the level.

- To increase the bass or treble: Press the SELECT UP button. (The bass or treble sound can be increased to up to +10 dB in steps of 2 dB.)
- To decrease the bass or treble: Press the SELECT DOWN button. (The bass or treble sound can be decreased to up to -10 dB in steps of 2 dB.)

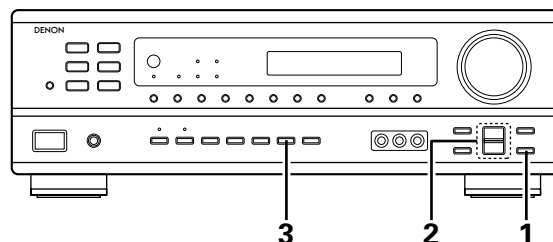
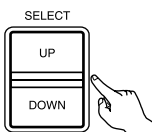

- 3** If you do not want the bass and treble to be adjusted, turn on the tone defeat mode.



※ The signals do not pass through the bass and treble adjustment circuits, providing higher quality sound.

[2] Listening over headphones

- 1** Connect the headphones to the PHONES jack of the front panel.

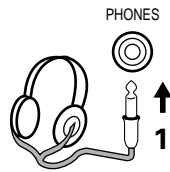

- 2** Press the SPEAKER A or B button turn the speaker off.

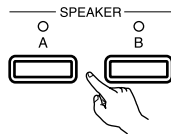

NOTE:

To prevent hearing loss, do not raise the volume level excessively when using headphones.

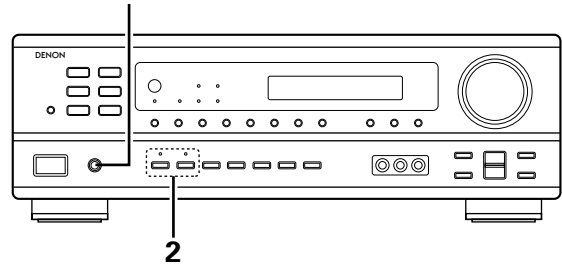

※ **Caution:** No sound is produced from the headphones when speakers A or B are turned on.

[3] Turning the sound off temporarily (muting)

- 1** Use this to turn off the audio output temporarily. Press the MUTING button.
 ※ Cancelling MUTING mode. Press the MUTING button again. Muting will also be cancelled when MASTER VOL is adjusted up or down.

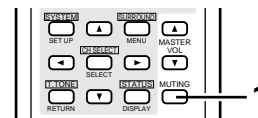

[4] Combining the currently playing sound with the desired image

- 1** Simulcast playback
 Use this switch to monitor a video source other than the audio source.
 Press the VIDEO SELECT button repeatedly until the desired source appears on the display.
 ※ Cancelling simulcast playback.
 • Select "SOURCE" using the video select button.
 • Switch the program source to the component connected to the video input.

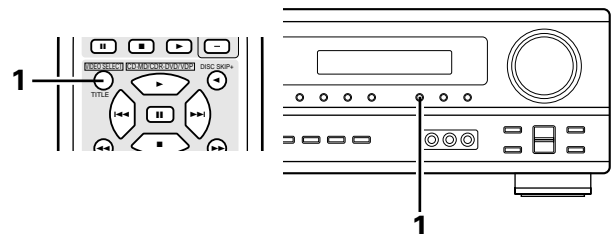
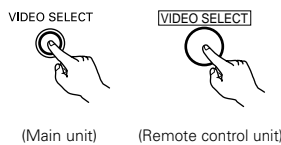

[5] Checking the currently playing program source, etc.

- 1** Front panel display
 • Descriptions of the unit's operations are also displayed on the front panel display. In addition, the display can be switched to check the unit's operating status while playing a source by pressing the STATUS button.

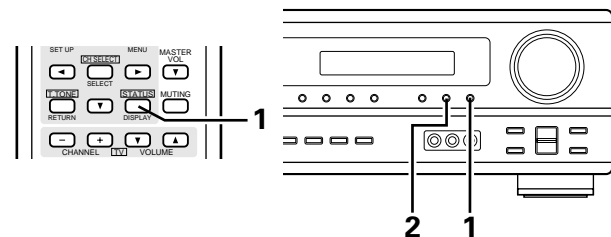
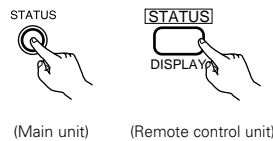

- 2** Using the dimmer function
 • Use this to change the brightness of the display.
 The display brightness changes in four steps (bright, medium, dim and off) by pressing the main unit's DIMMER button repeatedly.
 ※ The brightness changes in 3 steps each time the button is pressed, and finally the display turns off.



Playback using the external input (EXT. IN) jacks

- 1** Set the external input (EXT. IN) mode.
 Press the EXT. IN to switch the external input.
- 

EXT. IN
(Main unit)

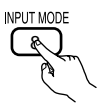

INPUT MODE
(Remote control unit)

Once this is selected, the input signals connected to the FL (front left), FR (front right), C (center), SL (surround left), and SR (surround right) channels of the EXT. IN jacks are output directly to the front (left and right), center, surround (left and right) speaker systems without passing through the surround circuitry.
 In addition, the signal input to the SW (subwoofer) jack is output to the PRE OUT SUBWOOFER jack.

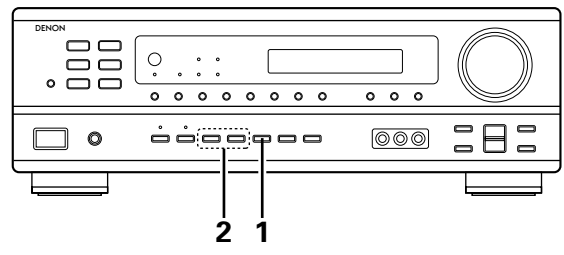

- 2** Cancelling the external input mode
 To cancel the external input (EXT. IN) setting, press the INPUT MODE (AUTO, PCM, DTS) or ANALOG button to switch to the desired input mode. (See page 25.)

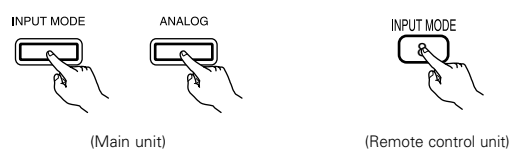

- When the input mode is set to the external input (EXT. IN), the play mode (STEREO, DOLBY/DTS SURROUND, 5CH STEREO or DSP SIMULATION) cannot be set.

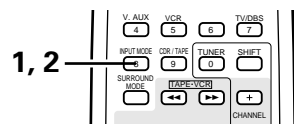

- NOTES:**
- In play modes other than the external input mode, the signals connected to these jacks cannot be played. In addition, signals cannot be output from channels not connected to the input jacks.
 - The external input mode can be set for any input source. To watch video while listening to sound, select the input source to which the video signal is connected, then set this mode.

Recording the program source (recording the source currently being monitored)

- 1** Follow step 1 to 3 under "Playing the input source".
- 2** Start recording on the tape or video deck.
 For instructions, refer to the component's operating instructions.

Simultaneous recording

The signals of the source selected with the function selector button are output simultaneously to the CDR/TAPE and VCR REC OUT jacks. If a total of two tape and/or video decks are connected and set to the recording mode, the same source can be recorded simultaneously on every decks.

- NOTE:**
- The AUDIO IN's signal selected with the function selector button are output to the CDR/TAPE and VCR AUDIO OUT jacks.

13 SURROUND

Before playing with the surround function

- Before playing with the surround function, be sure to use the test tones to adjust the playback level from each speakers. This adjustment can be performed from the remote control unit, as described below.
- The adjustment with the test tones is only effective in the DOLBY/DTS SURROUND modes. The adjusted playback levels for the different surround modes are automatically stored in the memory of each surround modes.

1 Set the DOLBY/DTS SURROUND (Dolby Pro Logic II or Dolby Digital or DTS) modes.

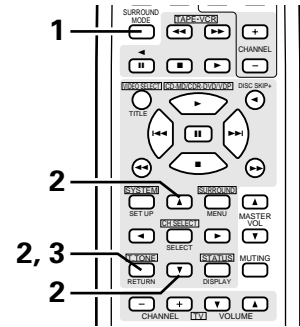
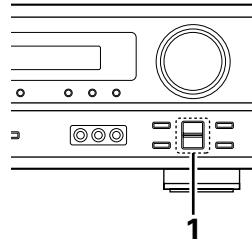
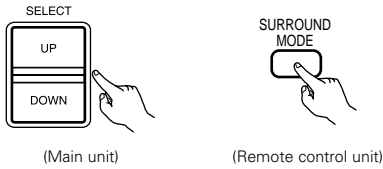

2 Press the TEST TONE button.

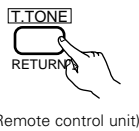

Test tones are output from the different speakers. Use the channel volume adjust buttons to adjust so that the volume of the test tones is the same for all the speakers.

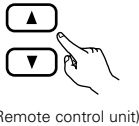

NOTE: Please make sure the "AUDIO" position of the slide switch on the remote control unit.

3 After completing the adjustment, press the TEST TONE button again.

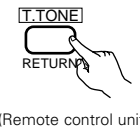

- After adjusting using the test tones, adjust the channel levels either according to the playback sources or to suit your tastes, as described below.

1 Select the speaker whose level you want to adjust.



The channel switches as shown below each time the button is pressed.

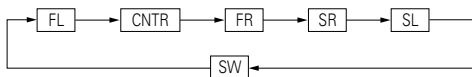

NOTE: Please make sure the "AUDIO" position of the slide switch on the remote control unit.

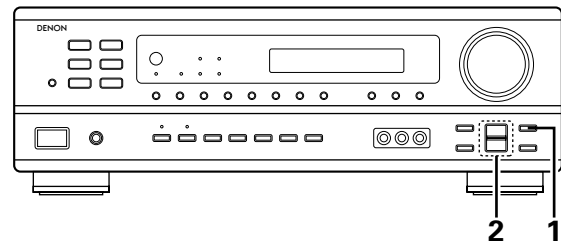

2 Adjust the level of the selected speaker.

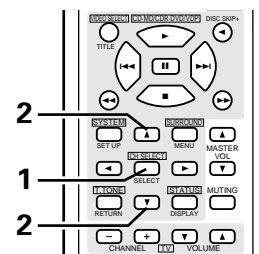
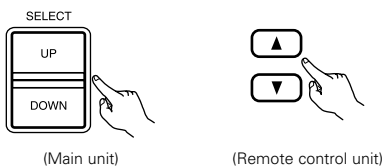

- ※ The level of the selected speaker can be adjusted within the range of +12 to -12 dB using the SELECT (up and down) buttons.
- ※ Default setting of channel level is 0 dB.

Dolby Surround Pro Logic II mode

1 Select the function to which the component you want to play is connected.

EX:

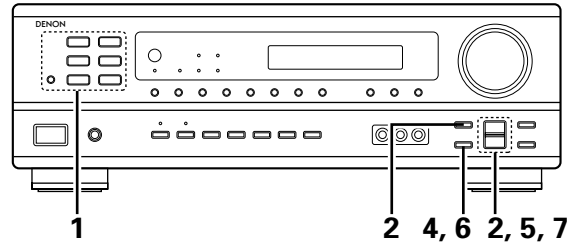

2 Select the Dolby Surround Pro Logic II mode.

Select the DOLBY PRO LOGIC II mode using the SELECT buttons.

The surround mode switches when the SURROUND MODE button is pressed. Select the DOLBY PRO LOGIC II mode.

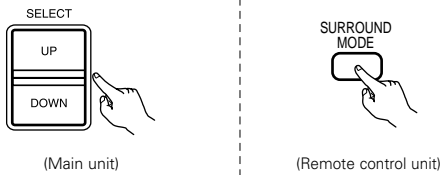

- The Dolby Pro Logic indicator lights.

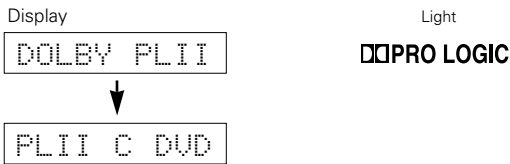

3 Play a program source with the **DS** DOLBY SURROUND mark.

- For operating instructions, refer to the manuals of the respective components.

4 Select the surround parameter mode.

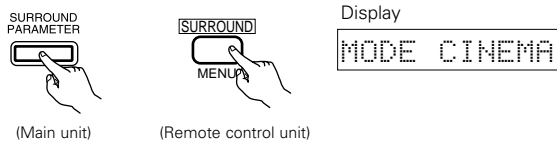

※ To perform this operation from the remote control unit, check that the mode selector switch is set to "AUDIO".

5 Select the optimum mode for the source.

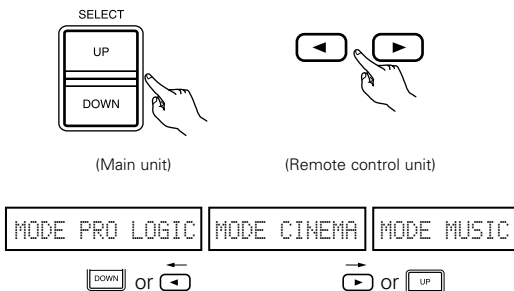

6 Set the surround parameters according to the mode.

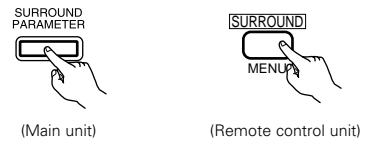

- The mode switches as shown below each time the button is pressed.

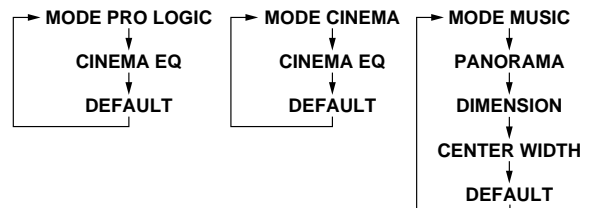

7

Set the various surround parameters.

• **CINEMA EQ setting**

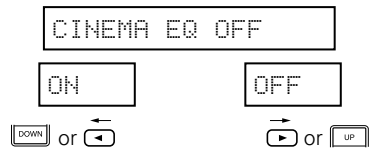

• **PANORAMA setting**

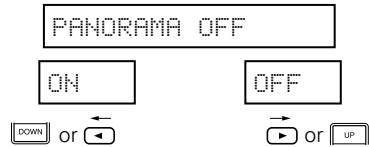

• **DIMENSION setting**

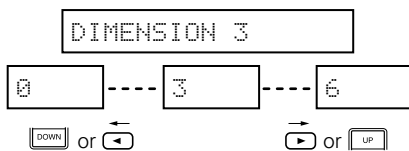

• **CENTER WIDTH setting**

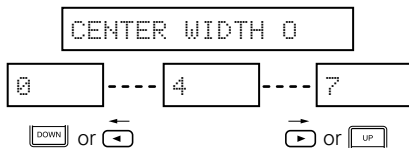

• **DEFAULT setting**

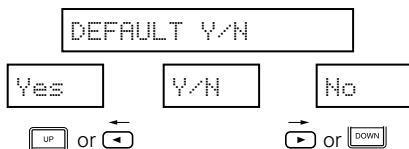

※ Select "Yes" to reset to the factory defaults.

NOTE:

- When making parameter settings, the display will return to the regular condition several seconds after the last button was pressed and the setting will be completed.

Surround parameters ①

Pro Logic II Mode:

The Cinema mode is for use with stereo television shows and all programs encoded in Dolby Surround.

The Music mode is recommended as the standard mode for autosound music systems (no video), and is optional for A/V systems.

The Pro Logic mode offers the same robust surround processing as original Pro Logic in case the source contents is not of optimum quality.

Select one of the modes ("Cinema", "Music" or "Pro Logic").

Panorama Control:

This mode extends the front stereo image to include the surround speakers for an exciting "wraparound" effect with side wall imaging.

Select "OFF" or "ON".

Dimension Control:

This control gradually adjust the soundfield either towards the front or towards the rear.

The control can be set in 7 steps from 0 to 6.

Center Width Control:

This control adjust the center image so it may be heard only from the center speaker; only from the left/right speakers as a phantom image; or from all three front speakers to varying degrees.

The control can be set in 8 steps from 0 to 7.

※ Stop pressing buttons once you have completed setting the surround parameters. After several seconds the normal display reappears and the settings you have made are automatically set.

Dolby Digital mode (only with digital input) and DTS Surround (only with digital input)

1 Select the input source.

Playback with a digital input

① Select an input source set to digital (COAXIAL/OPTICAL) (see page 20).

EX:



② Set the input mode to "AUTO" or DTS.

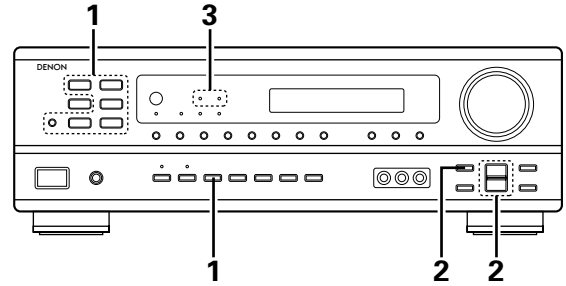

2 Select the Dolby/DTS Surround mode.

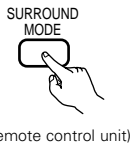

When performing this operation from the main unit's panel, press the SURROUND MODE button, then press the SELECT buttons and select "DOLBY/DTS".

- The following appears on the display. (DOLBY PLII, DOLBY PROLOGIC, DOLBY DIGITAL, DTS)

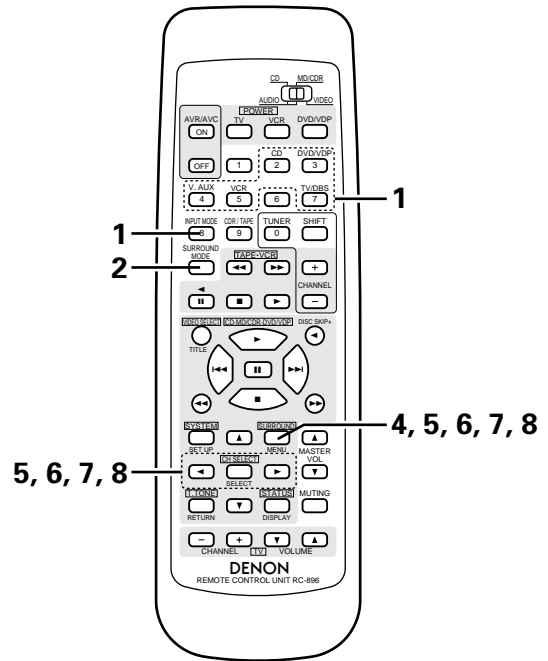
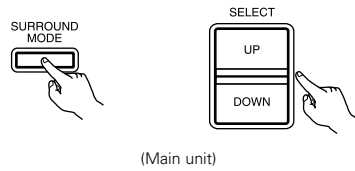

3 Play a program source with the , mark.

- Light • The Dolby Digital indicator lights when playing Dolby Digital sources.
- Light • The DTS indicator lights when playing DTS sources.

4 Set the surround parameter according to the source. First, press the SURROUND button.

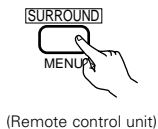

NOTE: Please make sure the "AUDIO" position of the slide switch on the remote control unit.

5 Use the (left) and (right) buttons to set the CINEMA EQ.

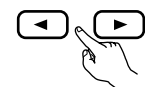

CINEMA EQ OFF

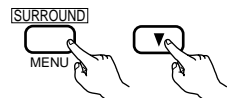
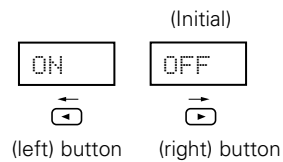

Press the SURROUND or (down) button to switch to the D. COMP. setting.

6

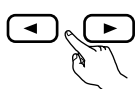

(Remote control unit)

Use the ◀ (left) and ▶ (right) buttons to set the D. COMP.

D.COMP. OFF

(Initial)

OFF LOW MID HIGH



(left) button



(right) button

SURROUND



(Remote control unit)

Press the SURROUND or ▼ (down) button to switch to the LFE setting.

NOTE:

This parameter is not displayed during DTS playback.

7

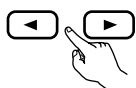

(Remote control unit)

Use the ◀ (left) and ▶ (right) buttons to set the LFE level.

LFE 0dB

- The level can be adjusted in units of 1 dB from -10 to 0 dB.
Set to the desired level according to the speaker systems being used and the source to be played.

SURROUND



(Remote control unit)

Press the SURROUND or ▼ (down) button to switch to the default setting.

8



(Remote control unit)

To reset the settings to the factory defaults, use the ◀ (left) and ▶ (right) buttons to display "Yes".

DEFAULT Y/N

YES

NO



(left) button



(right) button

SURROUND



(Remote control unit)

Press the SURROUND or ▼ (down) button to switch to the CINEMA EQ. setting.

NOTE:

- When making parameter settings, the display will return to the regular condition several seconds after the last button was pressed and the setting will be completed.

Surround parameters ②**CINEMA EQ. (Cinema Equalizer):**

The Cinema EQ function gently decreases the level of the extreme high frequencies, compensating for overly-bright sounding motion picture soundtracks. Select this function if the sound from the front speakers is too bright.

This function only works in the Dolby Pro Logic, Dolby Digital and DTS Surroundmodes. (The same contents are set for all operating modes.)

D.COMP. (Dynamic Range Compression):

Motion picture soundtracks have tremendous dynamic range (the contrast between very soft and very loud sounds). For listening late at night, or whenever the maximum sound level is lower than usual, the Dynamic Range Compression allows you to hear all of the sounds in the soundtrack (but with reduced dynamic range). (This only works when playing program sources recorded in Dolby Digital.) Select one of the four parameters ("OFF", "LOW", "MID" (middle) or "HI" (high)). Set to OFF for normal listening.

LFE (Low Frequency Effect):

Program source and adjustment range

1. Dolby Digital: -10 dB to 0 dB

2. DTS Surround: -10 dB to 0 dB

※ **When Dolby Digital encoded software is played, it is recommended that the LFE LEVEL be set to 0 dB for correct Dolby Digital playback.**

※ **When DTS encoded movie software is played, it is recommended that the LFE LEVEL be set to 0 dB for correct DTS playback.**

※ **When DTS encoded music software is played, it is recommended that the LFE LEVEL be set to -10 dB for correct DTS playback.**

14 DSP SURROUND SIMULATION

- This unit is equipped with a high performance DSP (Digital Signal Processor) which uses digital signal processing to synthetically recreate the sound field. One of 7 preset surround modes can be selected according to the program source and the parameters can be adjusted according to the conditions in the listening room to achieve a more realistic, powerful sound. These surround modes can also be used for program sources not recorded in Dolby Surround Pro Logic or Dolby Digital.

Surround modes and their features

1	5CH STEREO	In this mode, the signals of the front left channel are output from the left surround channel, the signals of the front right channel are output from the right surround channel, and the same (in-phase) component of the left and right channels is output from the center channel. This mode provides all speaker surround sound, but without directional steering effects, and works with any stereo program source.
2	MONO MOVIE (NOTE 1)	Select this when watching monaural movies for a greater sense of expansion.
3	ROCK ARENA	Use this mode to achieve the feeling of a live concert in an arena with reflected sounds coming from all directions.
4	JAZZ CLUB	This mode creates the sound field of a live house with a low ceiling and hard walls. This mode gives jazz a very vivid realism.
5	VIDEO GAME	Use this to enjoy video game sources.
6	MATRIX	Select this to emphasize the sense of expansion for music sources recorded in stereo. Signals consisting of the difference component of the input signals (the component that provides the sense of expansion) processed for delay are output from the surround channel.
7	VIRTUAL	Select this mode to enjoy a virtual sound field, produced from the front 2-channel speakers.

※ Depending on the program source being played, the effect may not be very noticeable.

In this case, try other surround modes, without worrying about their names, to create a sound field suited to your tastes.

NOTE 1: When playing sources recorded in monaural, the sound will be one-sided if signals are only input to one channel (left or right), so input signals to both channels. If you have a source component with only one audio output (monophonic camcorder, etc.) obtain a "Y" adaptor cable to split the mono output to two outputs, and connect to the L and R inputs.

NOTE:

Only the STEREO mode can be used when playing PCM signals with a sampling frequency of 96 kHz (such as from DVD-Video discs that contain 24 bit, 96 kHz audio). If such signals are input during playback in one of the other surround modes, the mode automatically switches to STEREO.

If the DTS signals are input during playback in VIRTUAL surround mode, the mode automatically switches to STEREO.

Personal Memory Plus

This set is equipped with a personal memorize function that automatically memorizes the surround modes and input modes selected for the input different sources. When the input source is switched, the modes set for that source last time it was used are automatically recalled.

※ The surround parameters, tone control settings and playback level balance for the different output channels are memorized for each surround mode.

DSP surround simulation

- To operate the surround mode and surround parameters from the remote control unit.

1 Select the surround mode for the input channel.

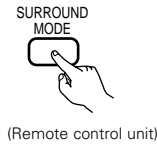

The surround mode switches in the following order each time the SURROUND MODE button is pressed:

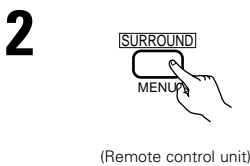
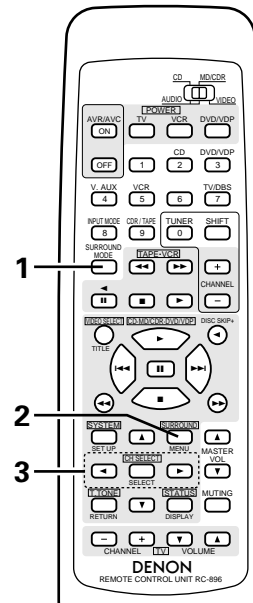
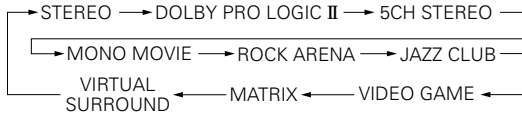

To enter the surround parameter setting mode, press the SURROUND button.

- The surround parameter switches in the following order each time the SURROUND button is pressed for the different surround modes.

- ROCK ARENA
- JAZZ CLUB
- VIDEO GAME
- MONO MOVIE

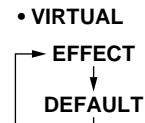
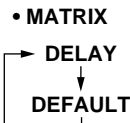
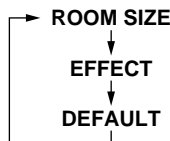

Display the parameter you want to adjust, then use the ◀ (left) and ▶ (right) buttons to set it.

(1) ROOM SIZE

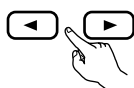

(Remote control unit)

Use the ◀ (left) and ▶ (right) buttons to set the room size.

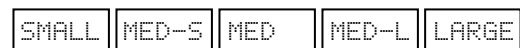
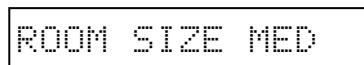

(Initial)
◀ (left) button ▶ (right) button

(2) EFFECT LEVEL

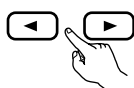

(Remote control unit)

Use the ◀ (left) and ▶ (right) buttons to set the effect level.

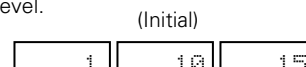
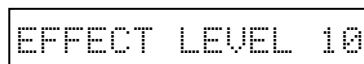

(Initial)
◀ (left) button ▶ (right) button

(3) DELAY TIME



(Remote control unit)

Use the ◀ (left) and ▶ (right) buttons to set the delay time.

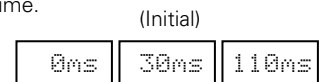

◀
(left) button

▶
(right) button

(4) DEFAULT



(Remote control unit)

To reset the settings to the factory defaults, use the ◀ (left) and ▶ (right) buttons to display "Yes".

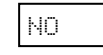
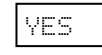
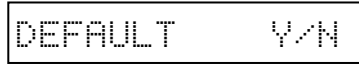

◀
(left) button

▶
(right) button

NOTE:

- When making parameter settings, the display will return to the regular condition several seconds after the last button was pressed and the setting will be completed.

- Operating the surround mode and surround parameters from the main unit's panel.

1 Press the SELECT buttons to select the surround mode.

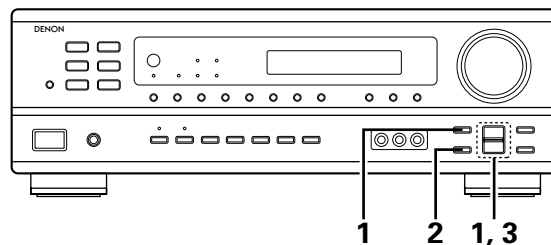
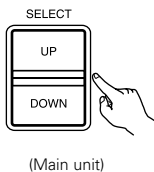

- When press the UP button

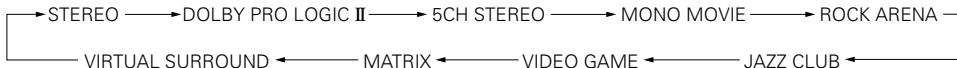

- When press the DOWN button

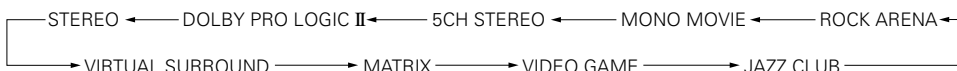

※ To select the surround mode while adjusting the surround parameters, channel volume or tone control, press the surround mode button then operate the selector.

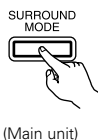

2 Press the SURROUND PARAMETER button.
Press and hold in the surround parameter button to select the parameter you want to set.

- The parameters which can be set differ for the different surround modes. (Refer to "Surround Modes and Parameters" on page 38.

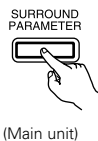

3 Display the parameter you want to adjust, then press the SELECT UP/DOWN buttons to set it.

NOTE:

- When playing PCM digital signals or analog signals in the 5CH STEREO, ROCK ARENA, JAZZ CLUB, VIDEO GAME, MONO MOVIE or MATRIX surround modes and the input signal switches to a digital signal encoded in Dolby Digital, the Dolby surround mode switches automatically. When the input signal switches to a DTS signal, the mode automatically switches to DTS surround.

Surround parameters ③

ROOM SIZE:

This sets the size of the sound field.

There are five settings: "small", "med.s" (medium-small), "medium", "med.l" (medium-large) and "large". "small" recreates a small sound field, "large" a large sound field.

EFFECT LEVEL:

This sets the strength of the surround effect.

The level can be set in 15 steps from 1 to 15. When the surround mode is set to "VIRTUAL", the effect level can be set in steps from 1 to 10. Lower the level if the sound seems distorted.

DELAY TIME:

In the "MATRIX" mode only, the delay time can be set within the range of 0 to 110 ms.

■ **Surround modes and parameters**

Mode	Channel output				When playing Dolby Digital signals	When playing DTS signals	When playing PCM signals	When playing ANALOG signals
	FRONT L/R	CENTER	SURROUND L/R	SUB-WOOFER				
STEREO	○	×	×	⊗	○	○	○	○
EXTERNAL INPUT	○	⊗	⊗	⊗	×	×	×	○
DOLBY PRO LOGIC II	○	⊗	⊗	⊗	○ *	×	○	○
DOLBY DIGITAL	○	⊗	⊗	⊗	○	×	×	×
DTS SURROUND	○	⊗	⊗	⊗	×	○	×	×
5CH STEREO	○	⊗	⊗	⊗	×	×	○	○
ROCK ARENA	○	⊗	⊗	⊗	×	×	○	○
JAZZ CLUB	○	⊗	⊗	⊗	×	×	○	○
VIDEO GAME	○	⊗	⊗	⊗	×	×	○	○
MONO MOVIE	○	⊗	⊗	⊗	×	×	○	○
MATRIX	○	⊗	⊗	⊗	×	×	○	○
VIRTUAL	○	×	×	⊗	○	×	○	○

* Only for 2 ch contents.

○ : Signal
 × : No signal
 ⊗ : Turned on or off by speaker configuration setting
 ○ : Able
 × : Unable

Mode	Parameter (default values are shown in parentheses)												
	TONE CONTROL	SURROUND PARAMETER				MODE	PRO LOGIC II MUSIC MODE ONLY			CINEMA EQ	Dolby Digital signals		DTS signals
		ROOM SIZE	EFFECT LEVEL	DELAY TIME			PANORAMA	DIMENSION	CENTER WIDTH		D.COMP.	LFE	LFE
STEREO	○ (0dB)	×	×	×	×	×	×	×	×	○ (OFF)	○ (0dB)	○ (0dB)	
EXTERNAL INPUT	○ (0dB)	×	×	×	×	×	×	×	×	×	×	×	
DOLBY PRO LOGIC II	○ (0dB)	×	×	×	○ (CINEMA)	○ (OFF)	○ (3)	○ (0)	○ (OFF)	○ (OFF)	○ (0dB)	-	
DOLBY DIGITAL	○ (0dB)	×	×	×	×	×	×	×	○ (OFF)	○ (OFF)	○ (0dB)	-	
DTS SURROUND	○ (0dB)	×	×	×	×	×	×	×	○ (OFF)	×	-	○ (0dB)	
5CH STEREO	○ (0dB)	×	×	×	×	×	×	×	×	×	×	×	
ROCK ARENA	○ (0dB)	○ (Medium)	○ (10)	×	×	×	×	×	×	×	×	×	
JAZZ CLUB	○ (0dB)	○ (Medium)	○ (10)	×	×	×	×	×	×	×	×	×	
VIDEO GAME	○ (0dB)	○ (Medium)	○ (10)	×	×	×	×	×	×	×	×	×	
MONO MOVIE	○ (0dB)	○ (Medium)	○ (10)	×	×	×	×	×	×	×	×	×	
MATRIX	○ (0dB)	×	×	○ (30msec)	×	×	×	×	×	×	×	×	
VIRTUAL	○ (0dB)	×	○ (10)	×	×	×	×	×	×	○ (OFF)	○ (0dB)	×	

○ : Adjustable
 × : Not adjustable

15 LISTENING TO THE RADIO

Auto preset memory

This unit is equipped with a function for automatically searching for FM broadcast stations and storing them in the preset memory.

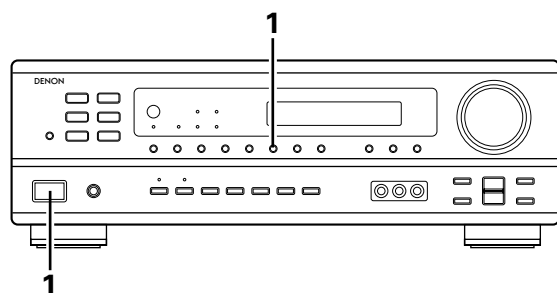

1 When the main unit's power operation switch turn on while pressing the set's MEMORY button the unit automatically begins searching for FM broadcast stations.



2 When the first FM broadcast station is found, that station is stored in the preset memory at channel A1. Subsequent stations are automatically stored in order at preset channels A2 to A8, B1 to B8, C1 to C8, D1 to D8 and E1 to E8, for a maximum of 40 stations.

3 Channel A1 is tuned in after the auto preset memory operation is completed.

NOTES:

- If an FM station cannot be preset automatically due to poor reception, use the "Manual tuning" operation to tune in the station, then preset it using the manual "Preset memory" operation.
- To interrupt this function, press the power operation button.

■ **DEFAULT VALUE**

AUTO TUNER PRESETS	
A1 ~ A8	87.5/89.1/98.1/107.9/90.1/90.1/90.1/90.1 MHz
B1 ~ B8	520/600/1000/1400/1500/1710 kHz/90.1/90.1 MHz
C1 ~ C8	90.1 MHz
D1 ~ D8	90.1 MHz
E1 ~ E8	90.1 MHz

Auto tuning

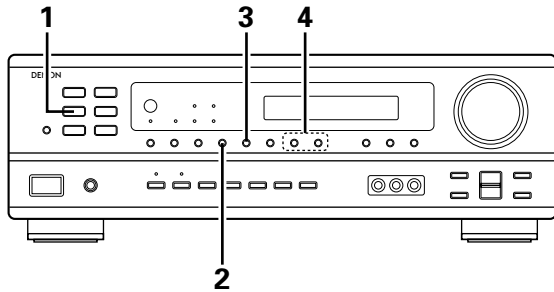

- 1** Set the input function to "TUNER".

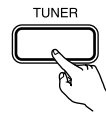

- 2** Watching the display, press the BAND button to select the desired band (AM or FM).



- 3** Press the MODE button to set the auto tuning mode.

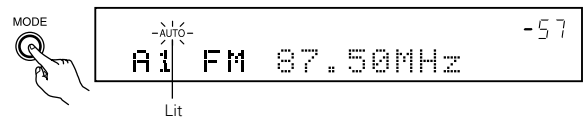

- 4** Press the TUNING UP or DOWN button.

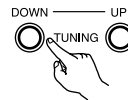

- Automatic searching begins, then stops when a station is tuned in.

NOTE:

- When in the auto tuning mode on the FM band, the "STEREO" indicator lights on the display when a stereo broadcast is tuned in. At open frequencies, the noise is muted and the "TUNED" and "STEREO" indicators turn off.

Manual tuning

- 1** Set the input function to "TUNER".

- 2** Watching the display, press the BAND button to select the desired band (AM or FM).

- 3** Press the MODE button to set the manual tuning mode. Check that the display's "AUTO" indicator turns off.

- 4** Press the TUNING UP or DOWN button to tune in the desired station. The frequency changes continuously when the button is held in.

NOTE:

- When the manual tuning mode is set, FM stereo broadcasts are received in monaural and the "STEREO" indicator turns off.

Preset stations

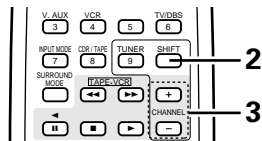
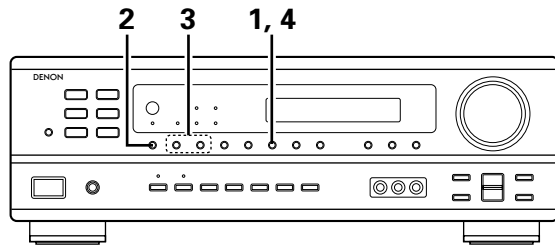

Preparations:

Use the "Auto tuning" or "Manual tuning" operation to tune in the station to be preset in the memory.

- 1 Press the MEMORY button.



- 2 Press the SHIFT button and select the desired memory block (A to E).

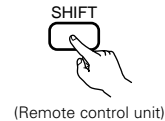

NOTE: Please make sure the "AUDIO" position of the slide switch on the remote control unit.

- 3 Press the PRESET UP or DOWN button to select the desired preset channel (1 to 8).

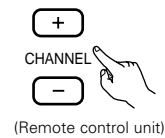
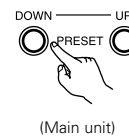

- 4 Press the MEMORY button again to store the station in the preset memory.



※ To preset other channels, repeat steps 1 to 4.

A total of 40 broadcast stations can be preset – 8 stations (channels 1 to 8) in each of blocks A to E.

Recalling preset stations

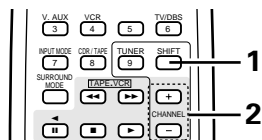
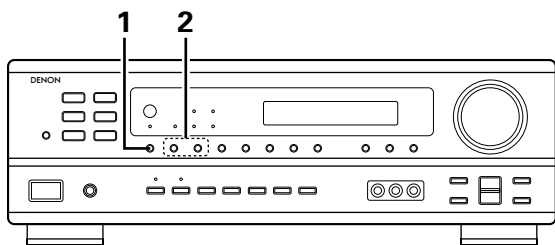

- 1 Watching the display, press the SHIFT button to select the preset memory block.

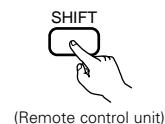

NOTE: Please make sure the "AUDIO" position of the slide switch on the remote control unit.

- 2 Watching the display, press the PRESET UP or DOWN button to select the desired preset channel.

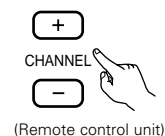
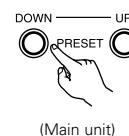

16 LAST FUNCTION MEMORY

- This unit is equipped with a last function memory which stores the input and output setting conditions as they were immediately before the power is switched off.
- The unit is also equipped with a back-up memory. This function provides approximately one week of memory storage when the main unit's power switch is off and with the power cord disconnected.

17 INITIALIZATION OF THE MICROPROCESSOR

When the indication of the display is not normal or when the operation of the unit does not show the reasonable result, the initialization of the microprocessor is required by the following procedure.

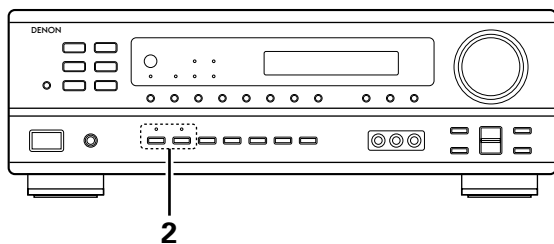

1 Switch off the unit and remove the AC cord from the wall outlet.

2 Hold the following SPEAKER A button and B button, and plug the AC cord into the outlet.

3 Check that the entire display is flashing with an interval of about 1 second, and release your fingers from the 2 buttons and the microprocessor will be initialized.

NOTES:

- If step 3 does not work, start over from step 1.
- If the microprocessor has been reset, all the button settings are reset to the default values (the values set upon shipment from the factory).

18 ADDITIONAL INFORMATION

Speaker setting examples

Here we describe a number of speaker settings for different purposes. Use these examples as guides to set up your system according to the type of speakers used and the main usage purpose.

(1) Basic setting

Use this setting if your main purpose is to listen to movie music and when using one set (two speakers) of regular single-way or two-way speakers as the surround speakers.

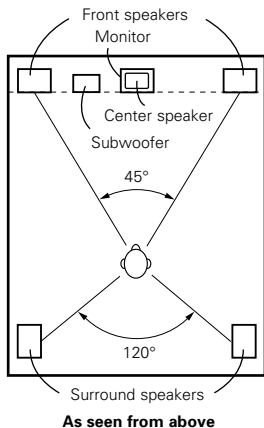

- Set the front speakers with their front surfaces as flush with the TV or monitor screen as possible. Set the center speaker between the front left and right speakers and no further from the listening position than the front speakers.
- Consult the owner's manual for your subwoofer for advice on placing the subwoofer within the listening room.
- If the surround speakers are direct-radiating (monopolar) then place them slightly behind and at an angle to the listening position and parallel to the walls at a position 60 to 90 centimeters (2 to 3 feet) above ear level at the prime listening position.

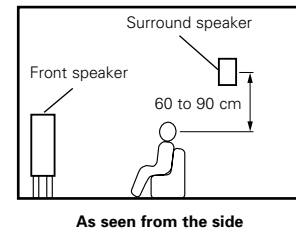

(2) Using diffusion type speakers for the surround speakers

For the greatest sense of surround sound envelopment, diffuse radiation speakers such as bipolar types, or dipolar types, provide a wider dispersion than is possible to obtain from a direct radiating speaker (monopolar). Place these speakers at either side of the prime listening position, mounted above ear level.

Path of the surround sound from the speakers to the listening position

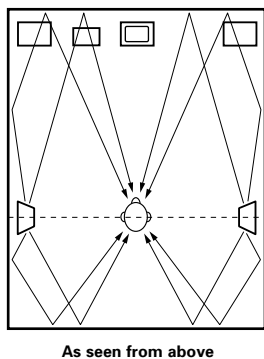

- Set the front speakers, center speaker and subwoofer in the same positions as in example (1).
- Set the surround speakers directly at the sides of the listening position and 60 to 90 centimeters (2 to 3 feet) above ear level.
- The signals from the surround channels reflect off the walls as shown on the diagram at the left, creating an enveloping and realistic surround sound presentation.

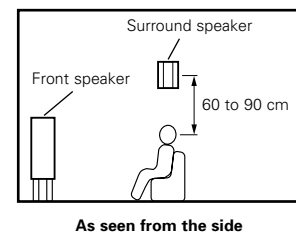

Surround

This unit is equipped with a digital signal processing circuit that lets you play program sources in the surround mode to achieve the same sense of presence as in a movie theater.

Dolby Surround

(1) Dolby Digital (Dolby Surround AC-3)

Dolby Digital is the multi-channel digital signal format developed by Dolby Laboratories.

Dolby Digital consists of up to "5.1" channels - front left, front right, center, surround left, surround right, and an additional channel exclusively reserved for additional deep bass sound effects (the Low Frequency Effects – LFE – channel, also called the ".1" channel, containing bass frequencies of up to 120 Hz).

Unlike the analog Dolby Pro Logic format, Dolby Digital's main channels can all contain full range sound information, from the lowest bass, up to the highest frequencies – 22 kHz. The signals within each channel are distinct from the others, allowing pinpoint sound imaging, and Dolby Digital offers tremendous dynamic range from the most powerful sound effects to the quietest, softest sounds, free from noise and distortion.

■ **Dolby Digital and Dolby Pro Logic**

Comparison of home surround systems	Dolby Digital	Dolby Pro Logic
No. recorded channels (elements)	5.1 ch	2 ch
No. playback channels	5.1 ch	4 ch
Playback channels (max.)	L, R, C, SL, SR, SW	L, R, C, S (SW - recommended)
Audio processing	Digital discrete processing Dolby Digital (AC-3) encoding/decoding	Analog matrix processing Dolby Surround
High frequency playback limit of surround channel	20 kHz	7 kHz

■ **Dolby Digital compatible media and playback methods**

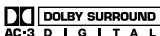
Marks indicating Dolby Digital compatibility:  and .

The following are general examples. Also refer to the player's operating instructions.

Media	Dolby Digital output jacks	Playback method (reference page)
LD (VDP)	Coaxial Dolby Digital RF output jack ※ 1	Set the input mode to "AUTO". (Page 25)
DVD	Optical or coaxial digital output (same as for PCM) ※ 2	Set the input mode to "AUTO". (Page 25)
Others (satellite broadcasts, CATV, etc.)	Optical or coaxial digital output (same as for PCM)	Set the input mode to "AUTO". (Page 25)

※ 1 Please use a commercially available adapter when connecting the Dolby Digital RF (AC-3RF) output jack of the LD player to the digital input jack.
Please refer to the instruction manual of the adapter when making connection.

※ 2 Some DVD digital outputs have the function of switching the Dolby Digital signal output method between "bit stream" and "(convert to PCM)". When playing in Dolby Digital surround on this unit, switch the DVD player's output mode to "bit stream". In some cases players are equipped with both "bit stream + PCM" and "PCM only" digital outputs. In this case connect the "bit stream + PCM" jacks to this unit.

(2) **Dolby Pro Logic II**

- Dolby Pro Logic II is a new multi-channel playback format developed by Dolby Laboratories using feedback logic steering technology and offering improvements over conventional Dolby Pro Logic circuits.
- Dolby Pro Logic II can be used to decode not only sources recorded in Dolby Surround (※) but also regular stereo sources into five channels (front left, front right, center, surround left and surround right) to achieve surround sound.
- Whereas with conventional Dolby Pro Logic the surround channel playback frequency band was limited, Dolby Pro Logic II offers a wider band range (20 Hz to 20 kHz or greater). In addition, the surround channels were monaural (the surround left and right channels were the same) with previous Dolby Pro Logic, but Dolby Pro Logic II they are played as stereo signals.
- Various parameters can be set according to the type of source and the contents, so it is possible to achieve optimum decoding (see page 30).

※ Sources recorded in Dolby Surround

These are sources in which three or more channels of surround have been recorded as two channels of signals using Dolby Surround encoding technology.

Dolby Surround is used for the sound tracks of movies recorded on DVDs, LDs and video cassettes to be played on stereo VCRs, as well as for the stereo broadcast signals of FM radio, TV, satellite broadcasts and cable TV.

Decoding these signals with Dolby Pro Logic makes it possible to achieve multi-channel surround playback. The signals can also be played on ordinary stereo equipment, in which case they provide normal stereo sound.

There are two types of DVD Dolby surround recording signals.

- ① 2-channel PCM stereo signals
- ② 2-channel Dolby Digital signals

When either of these signals is input to the AVR-1403/483, the surround mode is automatically set to Dolby Pro Logic II when the "DOLBY/DTS SURROUND" mode is selected.

■ **Sources recorded in Dolby Surround are indicated with the logo mark shown below.**

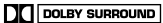
Dolby Surround support mark: 

Manufactured under license from Dolby Laboratories.
"Dolby", "Pro Logic" and the double-D symbol are trademarks of Dolby Laboratories.

DTS Digital Surround

Digital Theater Surround (also called simply DTS) is a multi-channel digital signal format developed by Digital Theater Systems.



DTS offers the same "5.1" playback channels as Dolby Digital (front left, front right and center, surround left and surround right) as well as the stereo 2-channel mode. The signals for the different channels are fully independent, eliminating the risk of deterioration of sound quality due to interference between signals, crosstalk, etc.

DTS features a relatively higher bit rate as compared to Dolby Digital (1234 kbps for CDs and LDs, 1536 kbps for DVDs) so it operates with a relatively low compression rate. Because of this the amount of data is great, and when DTS playback is used in movie theaters, a separate CD-ROM synchronized with the film is played.

With LDs and DVDs, there is of course no need for an extra disc; the pictures and sound can be recorded simultaneously on the same disc, so the discs can be handled in the same way as discs with other formats.

There are also music CDs recorded in DTS. These CDs include 5.1-channel surround signals (compared to two channels on current CDs). They do not include picture data, but they offer surround playback on CD players that are equipped with digital outputs (PCM type digital output required). DTS surround track playback offers the same intricate, grand sound as in a movie theater, right in your own listening room.

■ DTS compatible media and playback methods

Marks indicating DTS compatibility:  and .

The following are general examples. Also refer to the player's operating instructions.

Media	Dolby Digital output jacks	Playback method (reference page)
CD	Optical or coaxial digital output (same as for PCM) ※ 2	Set the input mode to "AUTO" or "DTS" (page 25). Never set the mode to "ANALOG" or "PCM". ※ 1
LD (VDP)	Optical or coaxial digital output (same as for PCM) ※ 2	Set the input mode to "AUTO" or "DTS" (page 25). Never set the mode to "ANALOG" or "PCM". ※ 1
DVD	Optical or coaxial digital output (same as for PCM) ※ 3	Set the input mode to "AUTO" or "DTS" (page 25).

- ※ 1 DTS signals are recorded in the same way on CDs and LDs as PCM signals. Because of this, the un-decoded DTS signals are output as random "hissy" noise from the CD or LD player's analog outputs. If this noise is played with the amplifier set at a very high volume, it may possibly cause damage to the speakers. To avoid this, be sure to switch the input mode to "AUTO" or "DTS" before playing CDs or LDs recorded in DTS. Also, never switch the input mode to "ANALOG" or "PCM" during playback. The same holds true when playing CDs or LDs on a DVD player or LD/DVD compatible player. For DVDs, the DTS signals are recorded in a special way so this problem does not occur.
- ※ 2 The signals provided at the digital outputs of a CD or LD player may undergo some sort of internal signal processing (output level adjustment, sampling frequency conversion, etc.). In this case the DTS-encoded signals may be processed erroneously, in which case they cannot be decoded by this unit, or may only produce noise. Before playing DTS signals for the first time, turn down the master volume to a low level, start playing the DTS disc, then check whether the DTS indicator on this unit (see page 32) lights before turning up the master volume.
- ※ 3 A DVD player with DTS-compatible digital output is required to play DTS DVDs. A DTS Digital Output logo is featured on the front panel of compatible DVD players. Recent DENON DVD player models feature DTS-compatible digital output – consult the player's owner's manual for information on configuring the digital output for DTS playback of DTS-encoded DVDs.

"DTS" and "DTS Digital Surround" are registered trademarks of Digital Theater Systems, Inc.

19 TROUBLESHOOTING

If a problem should arise, first check the following.

1. Are the connections correct ?
2. Have you operated the receiver according to the Operating Instructions ?
3. Are the speakers, turntable and other components operating properly ?

If this unit is not operating properly, check the items listed in the table below. Should the problem persist, there may be a malfunction. Disconnect the power immediately and contact your store of purchase.

	Symptom	Cause	Measures	Page
Common problems arising when listening to the CD, records, tapes, and FM broadcasts, etc.	DISPLAY not lit and sound not produced when power switch set to on.	<ul style="list-style-type: none"> • Power cord not plugged in securely. 	<ul style="list-style-type: none"> • Check the insertion of the power cord plug. • Turn the power off with the remote control unit after turning the POWER operation switch on. 	9 24
	DISPLAY lit but sound not produced.	<ul style="list-style-type: none"> • Speaker cords not securely connected. • Improper position of the audio function button. • Volume control set to minimum. • MUTING is on. • Digital signals not input Digital input selected. 	<ul style="list-style-type: none"> • Connect securely. • Set to a suitable position. • Turn volume up to suitable level. • Switch off MUTING. • Input digital signals or select input jacks to which digital signals are being input. 	13, 14 25 26 27 26
	DISPLAY not displayed and the "ON/STANDBY" LED flashes at a high rate	<ul style="list-style-type: none"> • Speaker terminals are short-circuited. • Block the ventilation holes of the set. • The unit is operating at continuous high power conditions and/or inadequate ventilation. 	<ul style="list-style-type: none"> • Switch power off, connect speakers properly, then switch power back on. • Turn off the set's power, then ventilate it well to cool it down. Once the set is cooled down, turn the power back on. • Turn off the set's power, then ventilate it well to cool it down. Once the set is cooled down, turn the power back on. 	13, 14 5, 14 5, 14
	Sound produced only from one channel.	<ul style="list-style-type: none"> • Incomplete connection of speaker cords. • Incomplete connection of input/output cords. 	<ul style="list-style-type: none"> • Connect securely. • Connect securely. 	13, 14 9 ~ 14
	Positions of instruments reversed during stereo playback.	<ul style="list-style-type: none"> • Reverse connections of left and right speakers or left and right input/output cords. 	<ul style="list-style-type: none"> • Check left and right connections. 	13, 14
Remote control unit:	This unit does not operate properly when remote control unit is used.	<ul style="list-style-type: none"> • Batteries dead. • Remote control unit too far from this unit. • Obstacle between this unit and remote control unit. • Different button is being pressed. • ⊕ and ⊖ ends of battery inserted in reverse. 	<ul style="list-style-type: none"> • Replace with new batteries. • Move closer. • Remove obstacle. • Press the proper button. • Insert batteries properly. 	15 15 15 — 15

Note:

When a subwoofer has been connected and the virtual surround function is being used, the signal played from the subwoofer channel is LFE only (only when playing Dolby Digital or DTS signals) for initial factory settings (i.e., the setting of the front speaker is "LARGE" and the setting of the subwoofer mode is "NORM").

When subwoofer effects are felt to be weak, while in the system setup mode try setting the subwoofer mode to "+MAIN", or the front speaker to "SMALL" in the Speaker Configuration settings.

Making these settings will result in the low-frequency sounds of the front channel being played from the subwoofer.

20 SPECIFICATIONS

■ Audio section

• Power amplifier

Rated output:

Front:	70 W + 70 W	(8 Ω/ohms, 20 Hz ~ 20 kHz with 0.08% T.H.D.)
	100 W + 100 W	(6 Ω/ohms, 1 kHz with 0.7% T.H.D.)
Center:	70 W	(8 Ω/ohms, 20 Hz ~ 20 kHz with 0.08% T.H.D.)
	100 W	(6 Ω/ohms, 1 kHz with 0.7% T.H.D.)
Surround:	70 W + 70 W	(8 Ω/ohms, 20 Hz ~ 20 kHz with 0.08% T.H.D.)
	100 W + 100 W	(6 Ω/ohms, 1 kHz with 0.7% T.H.D.)

Output terminals:

Front:	A or B	6 to 16 Ω/ohms
	A + B	12 to 16 Ω/ohms
Center/Surround:		6 to 16 Ω/ohms

• Analog

LINE input - SPEAKER OUT

Input sensitivity / input impedance:

200 mV / 47 kΩ/kohms

Frequency response:

10 Hz ~ 100 kHz: +1, -3 dB (TONE DEFEAT ON)

S/N ratio:

98 dB (IHF-A weighted) (TONE DEFEAT ON)

■ Video section

Input / output level and impedance:

1 Vp-p, 75 Ω/ohms

Frequency response:

5 Hz ~ 10 MHz — +1, -3 dB

■ Tuner section

Receiving range:

[FM] (note: μV at 75 Ω/ohms, 0 dBf = 1×10^{-15} W)

87.50 MHz ~ 107.90 MHz

[AM]

520 kHz ~ 1710 kHz

Usable sensitivity:

1.0 μV (11.2 dBf)

18 μV

50 dB quieting sensitivity:

MONO 1.6 μV (15.3 dBf)

STEREO 23 μV (38.5 dBf)

S/N ratio:

MONO 80 dB (IHF-A weighted)

STEREO 75 dB (IHF-A weighted)

Total harmonic distortion:

MONO 0.15% (1kHz)

STEREO 0.3% (1kHz)

■ General

Power supply:

AC 120 V, 60 Hz

Power consumption:

3.7 A

Maximum external dimensions:

434 (W) x 147 (H) x 417 (D) mm (17-3/32" x 5-25/32" x 16-7/16")

Weight:

9.8 kg (21 lbs 9.7 oz)

■ Remote control unit (RC-896)

Batteries:

R6P/AA Type (two batteries)

External dimensions:

54 (W) x 172.5 (H) x 29 (D) mm (2-1/8" x 6-25/32" x 1-9/64")

Weight:

120 g (Approx. 4.2 oz) (including batteries)

* For purposes of improvement, specifications and design are subject to change without notice.

LIST OF PRESET CODES / LISTE DE CODES PRÉRÉGLÉS

DVD

Denon	*[11], 12
Hitachi	14
JVC	17
Onkyo	13, 15, 16
Panasonic	12, 18
Philips	24
Pioneer	19, 20, 21
RCA	23
Samsung	22
Sony	25
Toshiba	13
Yamaha	12, 26

VDP

Denon	01, 02, 03
Magnavox	05
Mitsubishi	02
Panasonic	03
Philips	05
Pioneer	02
RCA	02
Sony	04

VCR

Admiral	10
Aiwa	11, 12, 13, 14
Akai	15, 16, 17
Audio Dynamic	07, 09
Bell & Howell	08
Blaupunkt	04, 19
Brocsonic	20
Bush	15
Canon	04, 21
CGM	11, 22
Citizen	11
Craig	11
Curtis Mathis	05, 12, 21
Daewoo	21, 23, 24
DBX	07, 09
Dimensia	05
Emerson	20, 23
Fisher	08, 25
Funai	12
GE	05, 21, 62
Goldstar	11
Goodmans	23, 26
Grundig	22, 27

Hitachi	*[01], 02, 03, 04, 05
Instant Replay	21, 04
Itt/Nokia	08
JC Penny	02, 05, 07, 08, 09, 21
JVC	07, 09, 28, 29, 30, 31
Kendo	11
Kenwood	07, 09, 11
Loewe	11, 26
Luxor	10
LXI	02, 08, 11, 12, 25
Magnavox	04, 19, 21
Marantz	07, 09
Marta	11
Matsui	11
Memorex	21, 25
Minolta	02, 05
Mitsubishi	06, 28, 32, 33, 34, 35
Multitech	12, 32, 36
NEC	07, 09, 28, 61
Nokia	08, 10
Nokia Oceanic	10
Okano	16
Olympic	04, 21
Orion	20
Panasonic	04, 18, 21, 37, 56, 57, 63, 64
Pentax	02, 05
Philco	04, 21
Philips	04, 19, 21, 26, 38, 39
Phonola	26
Pioneer	04, 58
Quasar	04, 21
RCA/PROSCAN	01, 02, 04, 05, 19, 21, 24, 40, 41, 62
Realistic	08, 12, 21, 25, 33, 42
Samsung	36, 40, 43, 44, 45, 46
Sansui	09
Sanyo	08, 25, 47
Schneider	26
Scott	06, 24, 25, 32, 33, 34, 36, 40
Seleco	15
Sharp	10, 42, 60
Siemens	08
Signature 2000	10, 12
Sony	48, 49, 50, 51, 52, 53
Sylvania	04, 12, 19, 21
Symphonic	12
Tandberg	23
Tashiro	11

Tatung	07, 09
Teac	07, 09, 12
Technics	04, 21
Telefunken	54, 55
Thorn	08, 11
Toshiba	24, 41, 59
Universum	11, 20, 54
W. WHouse	11
Wards	10, 11, 25, 42
Yamaha	06, 07, 08, 09

TV

Admiral	06, 07
Aiwa	08
Akai	09, 10
Alba	10
AOC	03
Bell & Howell	06
Bestar	11
Blaupunkt	12, 13
Blue sky	11
Brandt	14
Brocsonic	03
Bush	10
Clatronic	11
Craig	15
Croslex	16
Curtis Mathis	03, 17
Daewoo	03, 11, 15, 18, 19
Daytron	04
Dual	11
Emerson	03, 04, 15, 20
Ferguson	14, 45, 46
First line	11
Fisher	09, 21
Fraba	11
GE	03, 07, 22, 23, 24
Goldstar	03, 04, 11, 25
Goodmans	10, 11, 14
Grundig	12, 26, 27
Hitachi	*[01] , 02, 03, 04
ICE	10
Irradio	10
Itt/Nokia	28, 29
JC Penny	03, 07, 22, 25
JVC	10, 30, 31
Kendo	11
KTV	03, 04
Loewe	11, 32

LXI	03, 07, 16, 17, 21
Magnavox	03, 04, 16
Matsui	09
Mitsubishi	03, 05, 33, 34
NEC	03, 34
Nokia	28, 29
Nokia Oceanic	29
Nordmende	45, 46
Onwa	10
Panasonic	22, 23, 24, 35
Philco	03, 04, 16
Philips	16
Pioneer	17, 23, 36, 37
Portland	03, 38
Quasar	22, 23
Radio Shack	03, 05, 07
RCA	03, 07, 22, 38, 39, 40
SABA	14, 41, 45, 46
Samsung	03, 04, 32, 42
Sanyo	09, 21, 48
Schneider	10
Scott	03
Sharp	04, 06, 20
Siemens	12
Signature	06
Sony	43
Sylvania	03, 16
Telefunken	41, 44, 45, 46
Thomson	14, 46
Toshiba	06, 17, 47
Videch	01, 03
Wards	03, 04, 20
Yamaha	05, 06

*[] : Preset codes set upon shipment from the factory.

*[] : Les codes pré-réglés diffèrent en fonction des livraisons de l'usine.

DVD preset codes Codes pré-réglés DVD	11	12
DENON Model No. Modèle numéro	DVD-1000 DVD-1500 DVD-2800 DVD-2800II DVM-1800	DVD-800 DVD-1600 DVD-2000 DVD-2500 DVD-3000 DVD-3300

DENON,Ltd.

16-11, YUSHIMA 3-CHOME, BUNKYOU-KU, TOKYO 113-0034, JAPAN
Telephone: (03) 3837-5321

Printed in China 511 3929 002

DENON SERVICE NETWORK/ 服務網絡

- Please contact one of our overseas service centers, listed below, for follow-up service consultation.
- Wenden Sie sich für anfallende Wartungs- bzw. Reparaturarbeiten bitte an eine der folgenden aufgeführten Kundendienststellen.
- Adressez-vous à nos centres de service d'outre-mer indiqués ci-dessous, pour le service après-vente.
- Per il servizio dopo vendita rivolgete Vi al nostro centro di servizio estero appropriato della lista seguente.
- Para consultas de servicio por favor diríjase a cualquier de nuestros centros de servicio en el extranjero, enlistados abajo.
- Neem kontakt op met één van onze reparatie-inrichtingen in het buitenland, waarvan hier een lijst volgt, voor na-service.
- Ta kontakt med nedan angivna servicecentraler för rådföring om servicearbeten efter försäljningen.
- Favor contactar um de nossos centros de serviços internacionais, abaixo listados, para consulta de serviços de acompanhamento.
- 請據下表所列本公司海外服務中心查詢售後服務事宜。

Australia	Audio Products Australia Pty Ltd. 67 O'Riordan Street, Alexandria NSW 2015, Australia Tel: (02) 9669-3477 Fax: (02) 9578-0140
Austria	Digital-Professional-Audio Vertriebsges.m.b.H., 1170 Wien, Rupertusplatz 3 Tel: 0222-4501006~9, Fax: 0222-457679
Belgium	Transtel-Sabima P.V.B.A. Harmoniestraat 13, 2018 Antwerpen 1, België Tel: 03-237-3607
Canada	Denon Canada Inc. 17 Denison Street, Markham Ontario, Canada L3R 1B5 Tel: 905-475-4085 Fax: 905-475-4159
China	中國遠望機電技術發展中心(北京天龍特約維修中心)北京·東城區·建國門內東總布胡同28號 郵編: 100005 電話: (010) 64064558 傳真: (010) 64015151 天龍音響上海特約技術維修服務中心 上海金沙江路253號 郵編: 200062 電話: 86-21-6257-9958 傳真: 86-21-6260-5645
Czecho	EUROSTAR OSTORAVA s.r.o. areal Vodni stavby Praha a.s., budova A2 Dobronicka 635,148 00 Praha 4 Czech Rep. Tel: 02-6111-2901 Fax: 02-6111-2904
Denmark	Hifi Klubben A/S Dali Alle 1, 9610 Noerager, Denmark Tel: 45-96 72 10 00 Fax: 45-96 72 10 14
Finland	Suomen Hi-Fi Klubi OY Nylandsgatan 4-6, Helsingfors Tel: 09 25 30 36 12
France	Denon France S.A. 3 Boulevard Ney, 75018 Paris Tel: 44-89-68-69
F.R. Germany	Denon Electronic GmbH An der Landwehr 19, 41334 Nettetal Tel: +49 2157 12 08 78 Fax: +49 2157 12 08 13
Greece	KINOTECHNIKI LTD. 14, PYRGOU STR. 166 75, GYFADA ATHENS Tel: (01)960-1071 Fax: (01)960-1072
Hong Kong	DENON ASIA COMPANY LTD. Suite 501, Ocean Centre, Harbour City, Canton Road, Tsimshatsui Kowloon, Hong Kong Tel: 852-2516-6862, Fax: 852-2516-5940 天龍音響(亞洲)有限公司 香港九龍尖沙咀 廣東道海港城海洋中心5樓501室 電話: 852-2516-6862 傳真: 852-2516-5940
Hungary	InfoVox Ltd. Terez krt. 31, 1067 Budapest Hungary Tel / Fax: 01-302-2515
Iceland	Japis Ltd. Brautarholt 2, P.O.Box 396, 121 Reykjavik, Iceland Tel: 354-58009-800 Fax: 354-5800-888
Israel	Newpan Ltd. 14 Rosansky st. Rishon Lezion 75706. Tel: 03-9535900 Fax: 03-9616193
Indonesia	PT Autoaccindo Jaya. Cideng Barat No. 7 Jakarta, Indonesia Tel: 633-2730
Italy	Audiodelta S.r.l.19 Via Pietro Calvi 20129 Milan Italy Tel: 39-02-5411-6008 / 39-02-5412-8253 Fax: 39-02-5518-1961
Korea	SAM WON KOREA Co., Ltd. 1F, SANG-ROCK BLDG, #1629-3 SEOCHO-DONG, SEOCHO-KU, SEOUL 137-070, KOREA Tel: 02-521-1404 Fax: 02-3486-2135
Malaysia	HWEE SENG (ELECTRONICS) SDN BHD. 13-1, Jalan Raja Laut, 50350 Kuala Lumpur Malaysia Tel: 60-3-4041-8422 Fax: 60-3-4041-0563
Mexico	Labrador, S.A. de C.V. Callejon del Naranjo 35, Naucalpan, 53560, Edo. Mex., Mexico Tel: 52-5359-5161 Fax: 52-5357-1775
Netherlands	Penhold B.V. Popenbouwing 58, NL-4191 NZ Geldermalsen, Netherland Tel: 31-345-588 080 Fax: 31-345-588 085
New Zealand	Avalon Audio Corpn. Limited 6308 Great South Road Ellerslie Auckland, New Zealand Tel: 64-9-579-1280 Fax: 64-9-579-3350
Norway	Hi-Fi Klubben AS Sandakerveien 64 0483 Oslo Tel: 47 22 79 66 66 Fax: 47 22 79 66 67
Poland	HORN DISTRIBUTION S.A. Ulica Kurantow 34, 02-873 Warszawa Poland Tel: +48 22 649 30 71 Fax: +48 22 649 31 99
Portugal	Videoacustica Qta. Do Paizinho-Armazém 5-Estrada De Circunvalação-Apart. 3127 1303 Lisboa Codex Tel: (01)417-00-04/00-96 Fax: (01)418-80-93
Singapore	Hwee Seng (Electronics) Pte Ltd. 81 Genting Lane #02-02, Everich Industrial Building Singapore 349566 Tel: 65-746-3355 Fax: 65-743-1704
South Africa	Mandarin Distributors S.A. 10 Thora Crescent, Wynberg Ext.3 Sandton, P.O.Box 5137, Johannesburg Republic of South Africa Tel: 27-11-444-8445 Fax: 27-11-444-8363
Spain	Gaplasa S.A.AV. Ing. Conde de Torroja, 25, 28022 Madrid Tel: 91-329-29-60 Fax: 91-329-16-75
Sweden	Sveriges Hi-Fi Klubb Box 5116, S-402 23 Göteborg Tel: 031 33 51000
Switzerland	KOENIG APPARATE AG, Abteilung Elektronik. Eggbühlstrasse 28, CH-8052 Zürich, Switzerland Tel: 01-306-1626 Fax: 01-306-1690
Taiwan R.O.C.	KOLIN-DENON ENTERTAINMENT INC. 5th FL.,NO.63, Po-Ai Road, Taipei, Taiwan, R.O.C. Tel: (02)2381-5876 Fax: (02)2381-5811
進口廠商	歌林天龍音樂事業股份有限公司 台北市博愛市路63號10樓 電話: (02)2381-5876 傳真: (02)2381-5811
Thailand	Mahajak Development Co., Ltd. 46 Mahajak Building, Sukhumvit Soi 3 (Nana-Nua) Klongtoey, Bangkok Thailand. 10110 Tel: 66-2-256-0020 Fax: 66-2-253-1696
United Kingdom & Eire U.S.A.	Hayden Laboratories Ltd. Hayden House, Chiltern Hill, Chalfont St Peter, Gerrards Cross, Bucks, SL9 9UG Tel: 01753-888447 Fax: 01753-880109 DENON ELECTRONICS, a Division of Denon Corporation (U.S.A.) 19 Chapin Road, Pine Brook, NJ 07058-9777 Tel: 973-396-7499, Fax: 888-544-8434

- * If there is no service center in your local area, consult the outlet where the equipment was purchased.
- * Falls sich in Ihrer Nähe keine Kundendienststelle befindet, wenden Sie sich an das Geschäft, wo das Gerät gekauft wurde.
- * S'il n'y a aucun centre de service dans votre région, consultez votre revendeur.
- * Se nella Vostra zona non c'è il centro di servizio, rivolgete Vi al negozio dove avete acquistato l'apparecchio.
- * Si no hay centros de servicio en su área local, consulte en donde haya comprado su equipo.
- * Als er in uw streek geen reparatie-inrichting is, neemt u contact op met de vestiging waar u de apparatuur gekocht heeft
- * Saknas servicecentral i närheten där du bor, bör kontakt tas med återförsäljaren för apparaten.
- * Se não existir um centro de serviços em sua área local, consulte o estabelecimento onde o equipamento foi adquirido
- * 若當地無服務中心, 可向你購入本機的商號查詢。

DENON, Ltd.

13-16-11, YUSHIMA, BUNKYO-KU, TOKYO 113-0034, JAPAN

Telephone: (813) 3837 5321 Fax: (813) 3837 7804

Download from www.Somanuals.com. All Manuals Search And Download.

This warranty will be honored only in the U.S.A.

DENON[®]

LIMITED WARRANTY

Length of Warranty

This warranty on your DENON audio product which is distributed and warranted by DENON ELECTRONICS, a Division of DENON Corporation (U.S.A.) remains in effect for the following periods from the date of the original consumer purchase from an AUTHORIZED DENON ELECTRONICS, a Division of DENON Corporation (U.S.A.) DEALER.

Product Category

Turntables	(1) Autolift	(DP-L)	4 years
	(2) Full Automatic	(DP-F)	2 years
Tuners, Integrated Amplifiers		(TU, PMA)	3 years
Preamps, Digital Preamps, Poweramps, Head Amplifiers		(PRA, AVP, DAP, POA, HA)	3 years
Digital Surround Decoder		(AVD)	3 years
A/V Controllers, A/V Receivers, AM/FM Receivers		(AVC, AVR, DRA)	2 years
Compact Disc Players, DVD Players		(DCD, DCM, DP, DA, DVD, DVM)	1 year
Tape Recorders, Compact Disc Recorders, Minidisc Recorders		(DRM, DRR, DRS, DRW, CDR, DMD)	1 year
Karaoke Systems		(DCG, HMA)	1 year
Cartridges, Accessories		(DL, AU)	90 days

What is Covered

Except as specified below, this Warranty covers all defects in material and workmanship in this product. The following are not covered by the Warranty: (1) Any product which is not distributed in the U.S.A. by DENON ELECTRONICS (2) Any product which is not purchased in the U.S.A. from an authorized DENON dealer, unless the product is purchased through the U.S.A. Military Exchange Service where the Warranty will be One (1) year for all products listed above except in the case of Cartridges which will remain at 90 days. (Note: AUTHORIZED DENON DEALERS can be identified by DENON AUTHORIZED DEALER sticker displayed in the stores. If you are uncertain as to whether a dealer is a DENON AUTHORIZED DEALER, please contact DENON as listed below.) (3) Any product on which the serial number has been defaced, modified or removed. (4) Damaged deterioration or malfunction resulting from: a) Accident, act of nature, abuse, misuse, neglect, unauthorized product repair or modification or failure to follow instructions supplied with the product. b) Repair or attempted repair by anyone not authorized by DENON. c) Any shipment of the product (claim must be presented to carrier). (5) Items subject to wear from normal usage (tape heads, cartridges, stylus, battery, etc.). (6) Periodic check-ups which do not disclose any defect. (7) Use of the product outside the U.S.A. (8) Damaged magnetic tape or CD discs. (9) Use in industrial, commercial, and/or professional applications. (10) Any installation or removal charges resulting from product failure.

What We Will Pay For

If during the applicable warranty period from date of original consumer purchase your DENON audio product is found to be defective by DENON, DENON will repair, or at its option, replace with new, used or equivalent model, such defective product without charge for parts or labor.

How to Obtain Warranty Performance

If your unit ever needs service, it may be taken or shipped to any authorized DENON service station or DENON ELECTRONICS (if you are uncertain as to whether a service station is DENON authorized, please contact DENON as listed below.). In all other cases, the following procedures apply whenever your unit must be transported for warranty service:

- You are responsible for transporting your unit or arranging for its transportation.
- If shipment of your unit is required:
You must pay the initial shipping charges, but we will pay the return shipping charges if the repairs are covered by the Warranty.
- WHEN RETURNING YOUR UNIT FOR WARRANTY SERVICE, A COPY OF THE ORIGINAL SALES SLIP MUST BE ATTACHED.**
- You should include the following: your name, address, daytime telephone number, model and serial number of the product and a description of the problem. In the case of a Compact Disc Player, please enclose ONE (1) disc that the unit has failed with for test reasons. It will be returned with the unit.

THIS WARRANTY IS VALID IN THE U.S.A. ONLY.

If your product does not require service, but you have questions regarding its operation, please contact our Technical Services Department as listed below.

THIS WARRANTY IS EXPRESSLY MADE IN LIEU OF ALL OTHER WARRANTIES, EXPRESSED OR IMPLIED, INCLUDING WITHOUT LIMITATION, WARRANTIES OF MERCHANTABILITY AND FITNESS FOR A PARTICULAR PURPOSE.

OUR LIABILITY IS LIMITED TO THE REPAIR OR REPLACEMENT, AT OUR OPTION, OF ANY DEFECTIVE PRODUCT AND SHALL IN NO EVENT INCLUDE INCIDENTAL OR CONSEQUENTIAL COMMERCIAL OR PROPERTY DAMAGES OF ANY KIND.

SOME STATES DO NOT ALLOW LIMITATIONS ON HOW LONG AN IMPLIED WARRANTY LASTS AND/OR DO NOT ALLOW THE EXCLUSION OF INCIDENTAL OR CONSEQUENTIAL DAMAGES, SO THE ABOVE LIMITATIONS AND EXCLUSIONS MAY NOT APPLY TO YOU.

This Warranty gives you specific legal rights, but you may also have other rights which vary from state to state.

DENON[®] ELECTRONICS, a Division of DENON Corporation (U.S.A.)

Mailing address only: DENON ELECTRONICS,
P.O. Box 5370
Parsippany, N.J. 07054-5370

DENON

DENON ELECTRONICS,

222 New Road
Parsippany, N.J. 07054
(973) 396-7499
(888) 544-8434 FAX

DENON ELECTRONICS,

13825 Cerritos Corporate Dr., Suite B,
Cerritos, CA 90703-2456
(562) 565-1730
(562) 565-1740 FAX

DENON REGIONAL SUPER SERVICE CENTERS (Repair only — No parts orders please)

PYRAMID AUDIO

8711 Burnett Rd.
Building F, Suite 65
Austin, TX. 78758
(512) 458-8292
(512) 453-4542 FAX

UNITED RADIO

2949 Erie Boulevard East
Syracuse, N.Y. 13224
(315) 446-8700
(315) 446-8505 FAX

AUDIO SERVICES

544 Central Dr., Suite 101
Virginia Beach, VA 23454
(757) 498-8277
(757) 498-9554 FAX

ELECTRO SERVICES

2144 Columbia Avenue
Lancaster, PA 17603
(717) 397-0509
(717) 397-9565 FAX

INNER SOUND

1818 S.E. Division St.
Portland, OR 97202
(503) 238-1955
(503) 238-1787 FAX

DENON® WARRANTY REGISTRATION

MODEL NO.	SERIAL NO.	DATE SOLD
-----------	------------	-----------

DEALER NAME _____

DEALER ADDRESS _____

DEALER TELEPHONE _____

PURCHASER'S NAME		
STREET ADDRESS		
CITY	STATE	ZIP
AREA CODE	PHONE NO.	

A) Who/What was the greatest influence in your final decision to purchase this product?

- | | |
|--|---|
| 1. <input type="checkbox"/> Advertising | 5. <input type="checkbox"/> Price |
| 2. <input type="checkbox"/> Denon brand name | 6. <input type="checkbox"/> Product brochure/literature |
| 3. <input type="checkbox"/> Product features | 7. <input type="checkbox"/> Salesperson |
| 4. <input type="checkbox"/> Friend/Relative | 8. <input type="checkbox"/> Other (specify : _____) |

B) What other audio equipment do you presently own? Please indicate the make and model.

- | | |
|------------------------|--------------------------|
| Turntable _____ | Reel-to-Reel _____ |
| Cartridge _____ | Speakers _____ |
| Tonearm _____ | Headphones _____ |
| Head Amp/Transf. _____ | Blank Tape _____ |
| Amplifier _____ | Brand _____ Length _____ |
| Integrated Amp _____ | Accessories _____ |
| Tuner _____ | Cleaners, _____ |
| Receiver _____ | cables, _____ |
| Cassette Deck _____ | etc. _____ |

C) What equipment do you plan to purchase in the next 6 months?

Category _____

Price Level _____

D) Please list the periodicals (Magazines, newspapers, etc.) which you read regularly.

- _____

PLACE
STAMP
HERE

DENON[®] ELECTRONICS,
a Division of Denon Corporation (U.S.A.)
P.O. Box 5370
Parsippany, N.J. 07054

Free Manuals Download Website

<http://myh66.com>

<http://usermanuals.us>

<http://www.somanuals.com>

<http://www.4manuals.cc>

<http://www.manual-lib.com>

<http://www.404manual.com>

<http://www.luxmanual.com>

<http://aubethermostatmanual.com>

Golf course search by state

<http://golfingnear.com>

Email search by domain

<http://emailbydomain.com>

Auto manuals search

<http://auto.somanuals.com>

TV manuals search

<http://tv.somanuals.com>