

# DENON

AV SURROUND RECEIVER

# AVR-988

---

Owner's Manual

## SAFETY PRECAUTIONS



**CAUTION**  
**RISK OF ELECTRIC SHOCK**  
**DO NOT OPEN**



**CAUTION:**  
**TO REDUCE THE RISK OF ELECTRIC SHOCK, DO NOT REMOVE COVER (OR BACK). NO USER-SERVICEABLE PARTS INSIDE. REFER SERVICING TO QUALIFIED SERVICE PERSONNEL.**

The lightning flash with arrowhead symbol, within an equilateral triangle, is intended to alert the user to the presence of uninsulated "dangerous voltage" within the product's enclosure that may be of sufficient magnitude to constitute a risk of electric shock to persons.

The exclamation point within an equilateral triangle is intended to alert the user to the presence of important operating and maintenance (servicing) instructions in the literature accompanying the appliance.

**WARNING:**  
**TO REDUCE THE RISK OF FIRE OR ELECTRIC SHOCK, DO NOT EXPOSE THIS APPLIANCE TO RAIN OR MOISTURE.**

## SAFETY INSTRUCTIONS

1. Read Instructions – All the safety and operating instructions should be read before the product is operated.
2. Retain Instructions – The safety and operating instructions should be retained for future reference.
3. Heed Warnings – All warnings on the product and in the operating instructions should be adhered to.
4. Follow Instructions – All operating and use instructions should be followed.
5. Cleaning – Unplug this product from the wall outlet before cleaning. Do not use liquid cleaners or aerosol cleaners.
6. Attachments – Do not use attachments not recommended by the product manufacturer as they may cause hazards.
7. Water and Moisture – Do not use this product near water – for example, near a bath tub, wash bowl, kitchen sink, or laundry tub; in a wet basement; or near a swimming pool; and the like.
8. Accessories – Do not place this product on an unstable cart, stand, tripod, bracket, or table. The product may fall, causing serious injury to a child or adult, and serious damage to the product. Use only with a cart, stand, tripod, bracket, or table recommended by the manufacturer, or sold with the product. Any mounting of the product should follow the manufacturer's instructions, and should use a mounting accessory recommended by the manufacturer.
9. A product and cart combination should be moved with care. Quick stops, excessive force, and uneven surfaces may cause the product and cart combination to overturn.
10. Ventilation – Slots and openings in the cabinet are provided for ventilation and to ensure reliable operation of the product and to protect it from overheating, and these openings must not be blocked or covered. The openings should never be blocked by placing the product on a bed, sofa, rug, or other similar surface. This product should not be placed in a built-in installation such as a bookcase or rack unless proper ventilation is provided or the manufacturer's instructions have been adhered to.
11. Power Sources – This product should be operated only from the type of power source indicated on the marking label. If you are not sure of the type of power supply to your home, consult your product dealer or local power company. For products intended to operate from battery power, or other sources, refer to the operating instructions.
12. Grounding or Polarization – This product may be equipped with a polarized alternating-current line plug (a plug having one blade wider than the other). This plug will fit into the power outlet only one way. This is a safety feature. If you are unable to insert the plug fully into the outlet, try reversing the plug. If the plug should still fail to fit, contact your electrician to replace your obsolete outlet. Do not defeat the safety purpose of the polarized plug.
13. Power-Cord Protection – Power-supply cords should be routed so that they are not likely to be walked on or pinched by items placed upon or against them, paying particular attention to cords at plugs, convenience receptacles, and the point where they exit from the product.
15. Outdoor Antenna Grounding – If an outside antenna or cable system is connected to the product, be sure the antenna or cable system is grounded so as to provide some protection against voltage surges and built-up static charges. Article 810 of the National Electrical Code, ANSI/NFPA 70, provides information with regard to proper grounding of the mast and supporting structure, grounding of the lead-in wire to an antenna discharge unit, size of grounding conductors, location of antenna-discharge unit, connection to grounding electrodes, and requirements for the grounding electrode. See Figure A.
16. Lightning – For added protection for this product during a lightning storm, or when it is left unattended and unused for long periods of time, unplug it from the wall outlet and disconnect the antenna or cable system. This will prevent damage to the product due to lightning and power-line surges.
17. Power Lines – An outside antenna system should not be located in the vicinity of overhead power lines or other electric light or power circuits, or where it can fall into such power lines or circuits. When installing an outside antenna system, extreme care should be taken to keep from touching such power lines or circuits as contact with them might be fatal.
18. Overloading – Do not overload wall outlets, extension cords, or integral convenience receptacles as this can result in a risk of fire or electric shock.
19. Object and Liquid Entry – Never push objects of any kind into this product through openings as they may touch dangerous voltage points or short-out parts that could result in a fire or electric shock. Never spill liquid of any kind on the product.
20. Servicing – Do not attempt to service this product yourself as opening or removing covers may expose you to dangerous voltage or other hazards. Refer all servicing to qualified service personnel.
21. Damage Requiring Service – Unplug this product from the wall outlet and refer servicing to qualified service personnel under the following conditions:
  - a) When the power-supply cord or plug is damaged,
  - b) If liquid has been spilled, or objects have fallen into the product,
  - c) If the product has been exposed to rain or water,
  - d) If the product does not operate normally by following the operating instructions. Adjust only those controls that are covered by the operating instructions as an improper adjustment of other controls may result in damage and will often require extensive work by a qualified technician to restore the product to its normal operation,
  - e) If the product has been dropped or damaged in any way, and
  - f) When the product exhibits a distinct change in performance – this indicates a need for service.
22. Replacement Parts – When replacement parts are required, be sure the service technician has used replacement parts specified by the manufacturer or have the same characteristics as the original part. Unauthorized substitutions may result in fire, electric shock, or other hazards.
23. Safety Check – Upon completion of any service or repairs to this product, ask the service technician to perform safety checks to determine that the product is in proper operating condition.
24. Wall or Ceiling Mounting – The product should be mounted to a wall or ceiling only as recommended by the manufacturer.
25. Heat – The product should be situated away from heat sources such as radiators, heat registers, stoves, or other products (including amplifiers) that produce heat.

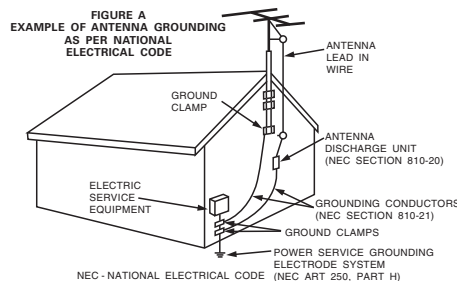

## FCC INFORMATION (For US customers)

### 1. PRODUCT

This product complies with Part 15 of the FCC Rules. Operation is subject to the following two conditions: (1) this product may not cause harmful interference, and (2) this product must accept any interference received, including interference that may cause undesired operation.

### 2. IMPORTANT NOTICE: DO NOT MODIFY THIS PRODUCT

This product, when installed as indicated in the instructions contained in this manual, meets FCC requirements. Modification not expressly approved by DENON may void your authority, granted by the FCC, to use the product.

### 3. NOTE

This product has been tested and found to comply with the limits for a Class B digital device, pursuant to Part 15 of the FCC Rules. These limits are designed to provide reasonable protection against harmful interference in a residential installation.

This product generates, uses and can radiate radio frequency energy and, if not installed and used in accordance with the instructions, may cause harmful interference to radio communications. However, there is no guarantee that interference will not occur in a particular installation. If this product does cause harmful interference to radio or television reception, which can be determined by turning the product OFF and ON, the user is encouraged to try to correct the interference by one or more of the following measures:

- Reorient or relocate the receiving antenna.
- Increase the separation between the equipment and receiver.
- Connect the product into an outlet on a circuit different from that to which the receiver is connected.
- Consult the local retailer authorized to distribute this type of product or an experienced radio/TV technician for help.

This Class B digital apparatus complies with Canadian ICES-003.

Cet appareil numérique de la classe B est conforme à la norme NMB-003 du Canada.

## NOTE ON USE / OBSERVATIONS RELATIVES A L'UTILISATION



- Avoid high temperatures. Allow for sufficient heat dispersion when installed in a rack.
- Éviter des températures élevées. Tenir compte d'une dispersion de chaleur suffisante lors de l'installation sur une étagère.



- Keep the unit free from moisture, water, and dust.
- Protéger l'appareil contre l'humidité, l'eau et la poussière.



- Do not let foreign objects into the unit.
- Ne pas laisser des objets étrangers dans l'appareil.

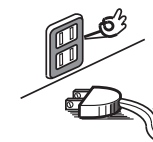

- Unplug the power cord when not using the unit for long periods of time.
- Débrancher le cordon d'alimentation lorsque l'appareil n'est pas utilisé pendant de longues périodes.

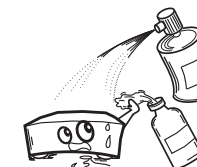

- Do not let insecticides, benzene, and thinner come in contact with the unit.
- Ne pas mettre en contact des insecticides, du benzène et un diluant avec l'appareil.

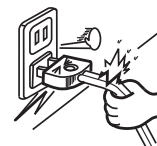

- Handle the power cord carefully. Hold the plug when unplugging the cord.
- Manipuler le cordon d'alimentation avec précaution. Tenir la prise lors du débranchement du cordon.



\* (For apparatuses with ventilation holes)

- Do not obstruct the ventilation holes.
- Ne pas obstruer les trous d'aération.



- Never disassemble or modify the unit in any way.
- Ne jamais démonter ou modifier l'appareil d'une manière ou d'une autre.

# Contents

## Getting Started

Accessories	2
Cautions on Handling	3
Cautions on Installation	3
About the Remote Control Unit	3
Inserting the Batteries	3
Operating Range of the Remote Control Unit	3
Part Names and Functions	4
Front Panel	4
Display	4
Rear Panel	5
Remote Control Unit	6

## Connections

Preparations	7
Cables Used for Connections	7
Video Conversion Function	8
On-Screen Display for Component Video Outputs and HDMI Output	8
Speaker Connections	9
Speaker Installation	9
Speaker Connections	9, 10
Connecting Equipment with HDMI connectors	11
Connecting the Monitor	12
Connecting the Playback Components	12
DVD Player	12
Record Player	13
CD Player	13
iPod®	14
TV/CABLE Tuner	14
Satellite Receiver	15
Connecting the Recording Components	15
Digital Video Recorder	15
Video Cassette Recorder	16
CD Recorder / MD Recorder / Tape Deck	16
Connections to Other Devices	17
Video Camera / Game Console	17
Component with Multi-channel Output connectors	17
External Power Amplifier	17
XM connector	18
Antenna terminals	18
Multi-zone	19
External Controller	19
Connecting the Power Cord	20
Once Connections are Completed	20

## Menu Operations

Operations	20
Example of Display of Default Values	21
Examples of On-screen Display and Front Display	21
Menu Map	22

## Auto Setup

Preparations	23
Auto Setup	24
1 Start Menu	24
Error Messages	25
2 Option	25
3 Parameter Check	25

## Manual Setup

Speaker Setup	26
1 Speaker Configuration	26
2 Subwoofer Setup	26
3 Distance	26, 27
4 Channel Level	27
5 Crossover Frequency	27
HDMI Setup	27
1 HDMI Audio Setup	27
2 HDMI Video Setup	28
Audio Setup	28
1 EXT. IN Subwoofer Level	28
2 2ch Direct/Stereo	28, 29
3 Dolby Digital Setup	29
4 Auto Surround Mode	29
5 Manual EQ	29
Zone2 Setup	30
1 Lch Level	30
2 Rch Level	30
3 Volume Level	30
4 Volume Limit	30
5 Power On Level	30
6 Mute Level	30
Option Setup	30
1 Amp Assign	30
2 Volume Control	31
3 Source Delete	31
4 On-Screen Display	31
5 Quick Select Name	31
6 Trigger Out	32
7 Remote ID Setup	32
8 2Way Remote	32
9 Display	32
10 Setup Lock	32

## Input Setup

Settings Related to Playing Input Sources	33
Auto Preset	33
Preset Skip	33
Preset Name	33
Input Mode	34
Rename	34
Assign	34, 35
iPod	35
Other	35, 36
Antenna Aiming	36

## Surround Modes

Standard Playback	36
Surround Playback of 2-channel Sources	36
Playing Multi-channel Sources (Dolby Digital, DTS, etc.)	36
DSP Simulation Playback	37
Stereo Playback	37
Direct Playback	37
Playback in the PURE DIRECT Mode	37

## Parameter

1 Surround Parameter	38, 39
2 Tone Control	40
3 Room EQ	40
4 RESTORER	40
5 Night Mode	41
6 Audio Delay	41

## Information

Status	41
1 Main zone	41
2 ZONE2	41
Audio Input Signal	41
HDMI Information	42
1 HDMI Signal Information	42
2 HDMI Monitor Information	42
Auto Surround Mode	42
Quick Select	42
Preset Station	42

**Playback**

**Preparations** .....43  
 Turning the Power On .....43  
 Selecting the input source .....43  
 Operations During Playback .....43  
**Playing Video and Audio Equipment** .....44  
 Basic Operation .....44  
**Listening to FM/AM Broadcasts** .....44  
 Basic Operation .....44  
 Presetting Radio Stations (Preset Memory) .....44  
 Listening to Preset Stations .....44  
**Listening to XM Satellite Radio Programs** .....45  
 Basic Operation .....45  
 Checking the XM Signal Strength and Radio ID .....46  
 Searching Categories .....46  
**iPod® Playback** .....47  
 Basic Operation .....47  
 Listening to Music .....47, 48  
 Viewing Still Pictures or Videos on the iPod .....48

**Other Operations and Functions**

**Other Operations** .....48  
 Playing Super Audio CD .....48  
 Recording on an External Device (REC OUT mode) .....49  
**Convenient Functions** .....50  
 Channel Level .....50  
 Fader Function .....50  
 Quick Select Function .....50  
 Personal Memory Plus Function .....50  
 Last Function Memory .....50  
 Backup Memory .....50  
 Resetting the Microprocessor .....50

**Remote Control Unit Operations**

**Operating DENON Audio Components** .....51  
**Presetting** .....51  
**Operating Preset Components** .....51 ~ 53  
**Punch Through Function** .....54

**Amp Assign / Multi-zone Connections and Operations**

**Multi-zone Settings with the Amp Assign Function** .....55 ~ 57  
**Multi-zone Settings and Operations with Zone Pre-out Output** .....57  
**Multi-zone Operations** .....58  
 Turning the Power On and Off .....58  
 Selecting the Input Source .....58  
 Adjusting the Volume .....58  
 Turning off the Sound Temporarily .....58

**Other Information** .....59 ~ 67

**Troubleshooting** .....68 ~ 70

**Specifications** .....71

**List of preset codes** ..... End of this manual

# Getting Started

Thank you for purchasing this DENON product. To ensure proper operation, please read this owner's manual carefully before using the product.  
 After reading them, be sure to keep them for future reference.

## Accessories

Check that the following parts are supplied with the product.

- ① Owner's manual ..... 1
  - ② Warranty (for North America model only) ..... 1
  - ③ Service station list ..... 1
  - ④ Power cord (Cord length: Approx. 7-31/64 ft /1.9 m) ..... 1
  - ⑤ Remote control (RC-1069) ..... 1
  - ⑥ R6P/AA batteries ..... 2
  - ⑦ FM indoor antenna ..... 1
  - ⑧ AM loop antenna ..... 1
  - ⑨ Setup microphone (Cord length: Approx. 25 ft / 7.6 m) ..... 1
-

## Cautions on Handling

### • Before turning the power switch on

Check once again that all connections are correct and that there are no problems with the connection cables.

- Power is supplied to some of the circuitry even when the unit is set to the standby mode. When traveling or leaving home for long periods of time, be sure to unplug the power cord from the power outlet.

### • About condensation

If there is a major difference in temperature between the inside of the unit and the surroundings, condensation (dew) may form on the operating parts inside the unit, causing the unit not to operate properly.

If this happens, let the unit sit for an hour or two with the power turned off and wait until there is little difference in temperature before using the unit.

### • Cautions on using mobile phones

Using a mobile phone near this unit may result in noise. If so, move the mobile phone away from this unit when it is in use.

### • Moving the unit

Turn off the power and unplug the power cord from the power outlet.

Next, disconnect the connection cables to other system units before moving the unit.

- Note that the illustrations in these instructions may differ from the actual unit for explanation purposes.

## Cautions on Installation

### Note:

**For proper heat dispersal, do not install this unit in a confined space, such as a bookcase or similar enclosure.**

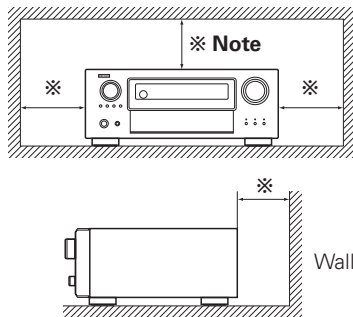

## About the Remote Control Unit

In addition to the AVR-988, the included remote control unit (RC-1069) can also be used to operate the equipment listed below.

- ① DENON system components
- ② Non-DENON system components
  - By setting the preset memory (page 51 ~ 53)

## Inserting the Batteries

- ① Lift the clasp and remove the rear lid.
- ② Load the two batteries properly as indicated by the marks in the battery compartment.

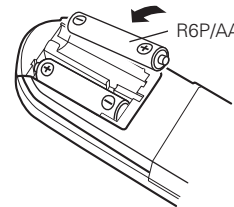
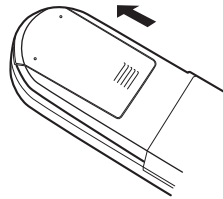

- ③ Put the rear cover back on.

### NOTE

- Replace the batteries with new ones if the set does not operate even when the remote control unit is operated close to the unit.
- The supplied batteries are only for verifying operation.
- When inserting the batteries, be sure to do so in the proper direction, following the “+” and “-” marks in the battery compartment.
- To prevent damage or leakage of battery fluid:
  - Do not use a new battery together with an old one.
  - Do not use two different types of batteries.
  - Do not attempt to charge dry batteries.
  - Do not short-circuit, disassemble, heat or dispose of batteries in flames.
- If the battery fluid should leak, carefully wipe the fluid off the inside of the battery compartment and insert new batteries.
- Remove the batteries from the remote control unit if it will not be in use for long periods.
- When replacing the batteries, have the new batteries ready and insert them as quickly as possible.

## Operating Range of the Remote Control Unit

Point the remote control unit at the remote sensor when operating it.

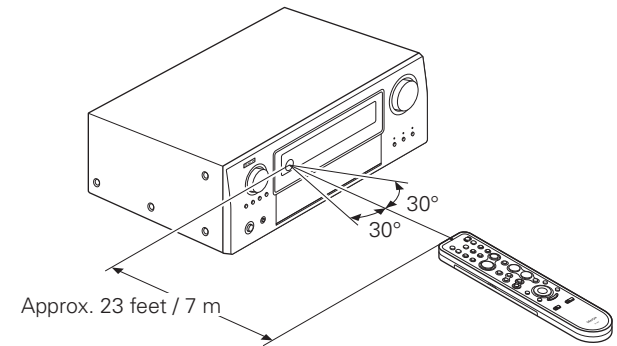

### NOTE

The set may function improperly or the remote control unit may not operate if the remote control sensor is exposed to direct sunlight, strong artificial light from an inverter type fluorescent lamp or infrared light.

# Part Names and Functions

For buttons not explained here, see the page indicated in parentheses ( ).

## Front Panel

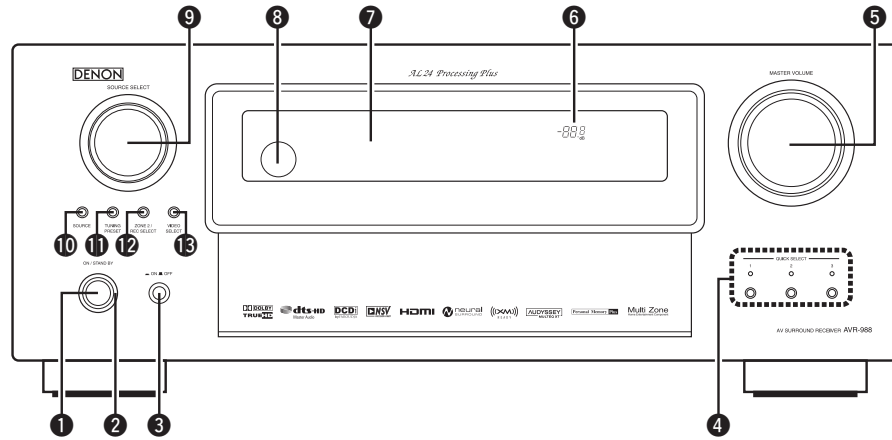

### (With the door open)

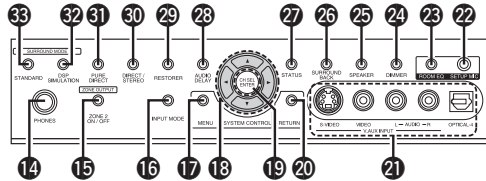

- 1 Power operation button (ON/STANDBY) ..... (43)
- 2 Power indicator ..... (43)
- 3 Power switch (ON OFF) ..... (43)
- 4 QUICK SELECT buttons / indicators ..... (50)
- 5 MASTER VOLUME control knob ..... (43)
- 6 Master volume indicator
- 7 Display
- 8 Remote control sensor ..... (3)
- 9 SOURCE SELECT knob ..... (43)
- 10 SOURCE button ..... (43)
- 11 TUNING PRESET button ..... (44)
- 12 ZONE2 / REC SELECT button ..... (49, 58)
- 13 VIDEO SELECT button ..... (35)

- 14 Headphones jack (PHONES) ..... (43)
- 15 ZONE2 ON/OFF button ..... (58)
- 16 INPUT MODE button ..... (34)
- 17 MENU button ..... (20)
- 18 Cursor buttons (Δ ▽ ◀ ▶) ..... (20)
- 19 CH SEL / ENTER button ..... (20, 50)
- 20 RETURN button ..... (20)
- 21 V.AUX INPUT connectors ..... (17)
- 22 SETUP MIC jack ..... (23)
- 23 ROOM EQ button ..... (40)
- 24 DIMMER button ..... (32)
- 25 SPEAKER button ..... (43)
- 26 SURROUND BACK button ..... (39)
- 27 STATUS button ..... (42)
- 28 AUDIO DELAY button ..... (41)
- 29 RESTORER button ..... (40)
- 30 DIRECT/STEREO button ..... (37)
- 31 PURE DIRECT button ..... (37)
- 32 DSP SIMULATION button ..... (37)
- 33 STANDARD button ..... (36)

## Display

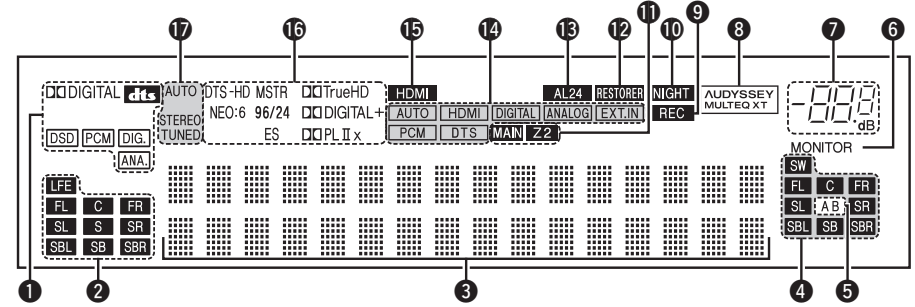

- 1 Input signal indicators
- 2 Input signal channel indicators  
These light when digital signals are input.
- 3 Information display  
The input source name, surround mode, setting values and other information are displayed here.
- 4 Output signal channel indicators
- 5 Front speaker indicator  
These light according to the settings of the front A and B speakers.
- 6 HDMI monitor indicator  
This lights when an HDMI monitor is detected.
- 7 Master volume indicator
- 8 AUDYSSEY MULTEQ XT indicator  
This lights when the room equalizer is selected.
- 9 Recording output source indicator  
This lights when the REC OUT mode is selected.
- 10 NIGHT indicator  
This lights when the night mode is selected.
- 11 Multi-zone indicators  
These light when the power for the respective zone is turned on.
- 12 RESTORER indicator  
This lights when the RESTORER mode is selected.
- 13 AL24 indicator  
This lights when AL24 Processing Plus is activated (page 61).
- 14 Input mode indicators
- 15 HDMI indicator  
This lights when playing using HDMI connections.
- 16 Decoder indicators  
These light when the respective decoders are operating.
- 17 Tuner reception mode indicators  
These light according to the reception conditions when the input source is set to "TUNER":
  - AUTO  
This lights when in the auto tuning mode.
  - STEREO  
In the FM mode, this lights when receiving analog stereo broadcasts.
  - TUNED  
This lights when the broadcast is properly tuned in.

# Rear Panel

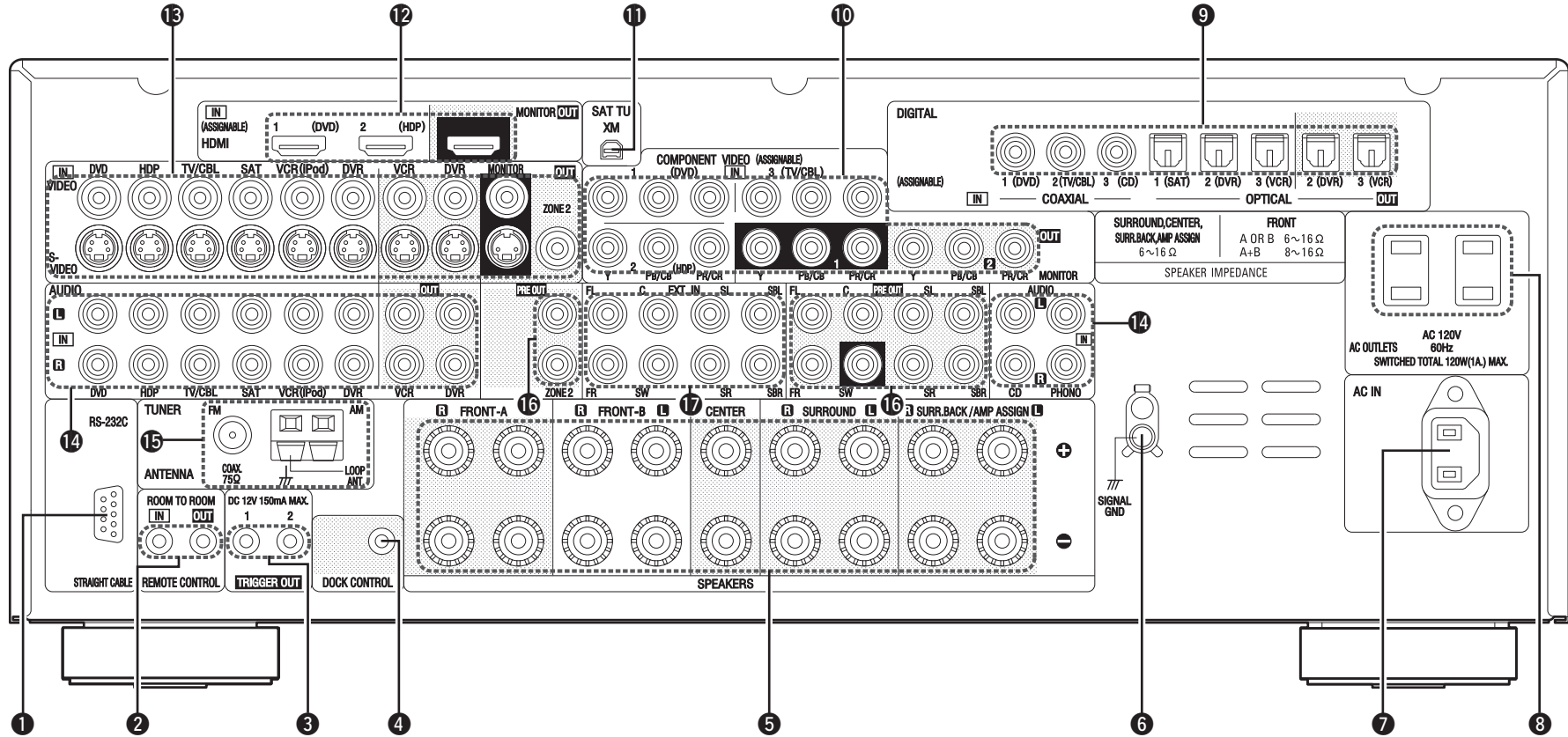

- 1 RS-232C connector ..... (19)
- 2 REMOTE CONTROL jacks ..... (19)
- 3 TRIGGER OUT jacks ..... (19)
- 4 DOCK CONTROL jack ..... (14)
- 5 Speaker terminals (SPEAKERS) ..... (9)
- 6 SIGNAL GND terminal ..... (13)
- 7 AC inlet (AC IN) ..... (20)
- 8 AC OUTLETS ..... (20)
- 9 Digital audio connectors (OPTICAL / COAXIAL) ..... (12, 15)
- 10 COMPONENT VIDEO connectors ..... (12)
- 11 XM connector (SAT TU) ..... (18)
- 12 HDMI connectors ..... (11)
- 13 VIDEO / S-VIDEO connectors ..... (12)
- 14 Analog audio connectors (AUDIO) ..... (12)
- 15 FM/AM antenna terminals (TUNER ANTENNA) ..... (18)
- 16 PRE OUT connectors ..... (17, 19)
- 17 EXT. IN connectors ..... (17)



# Remote Control Unit

## Front

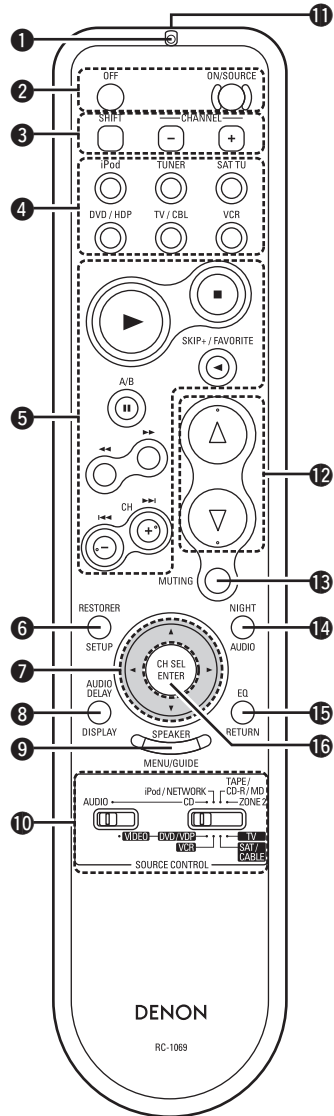

- 1 Indicator ..... (51)
- 2 Power buttons ..... (43)
- 3 Tuner system buttons ..... (44)
- 4 Source select buttons ..... (43)
- 5 System buttons ..... (47, 52)
- 6 RESTORER button ..... (40)
- 7 Cursor buttons (Δ▽◀▶) ..... (20)
- 8 AUDIO DELAY button ..... (41)
- 9 SPEAKER button ..... (43)
- 10 Mode selector switches ..... (20, 44)
- 11 Remote control signal transmitter ..... (3)
- 12 Master volume control buttons ..... (43)
- 13 MUTING button ..... (43, 58)
- 14 NIGHT button ..... (41)
- 15 EQ button ..... (40)
- 16 Channel select (CH SEL) / ENTER button ..... (20, 50)

## Rear

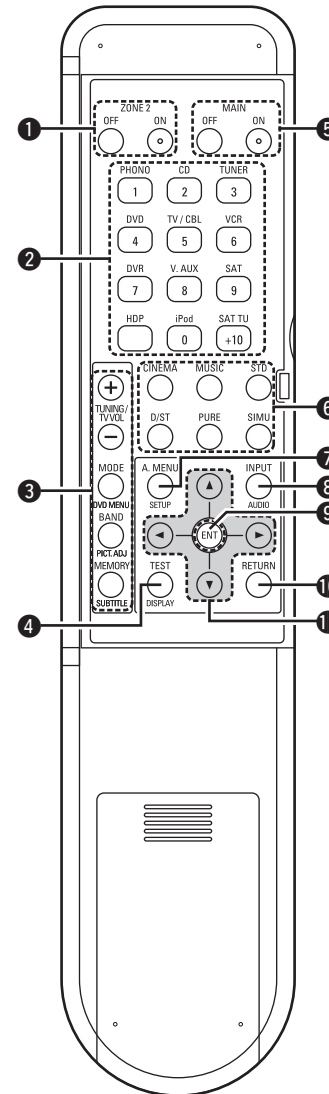

- 1 ZONE2 power buttons ..... (58)
- 2 Source select buttons ..... (43)
- 3 Tuner system buttons ..... (44)
- 4 Test Tone button (TEST) ..... (27)
- 5 Main zone power buttons (MAIN) ..... (58)
- 6 Surround mode buttons ..... (36, 37)
- 7 Amp menu button (A. MENU) ..... (20)
- 8 INPUT button ..... (34)
- 9 Enter button (ENT) ..... (20)
- 10 RETURN button ..... (20)
- 11 Cursor buttons (Δ▽◀▶) ..... (20)

### NOTE

If buttons on the front or rear are pressed strongly, the button on the opposite side will be activated too.

# Connections

Connections for all compatible audio and video signal formats are described in these operating instructions. Please select the types of connections suited for the equipment you are connecting. With some types of connections, certain settings must be made on the AVR-988. For details, refer to the instructions for the respective connection items below.













**NOTE**

- Do not plug in the power cord until all connections have been completed.
- When making connections, also refer to the operating instructions of the other components.
- Be sure to connect the left and right channels properly (left with left, right with right).
- Do not bundle power cords together with connection cables. Doing so can result in humming or noise.

## Preparations

### Cables Used for Connections

Select the cables according to the equipment being connected.

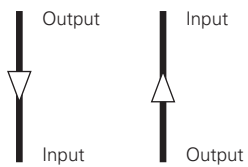
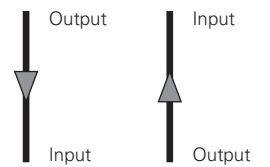
Audio cables	Video cables
<p><b>Coaxial digital connections</b></p> <p>(Orange)  Coaxial digital (75 Ω/ohms pin-plug) cable</p> <p><b>Optical digital connections</b></p> <p> Optical cable</p> <p><b>Analog connections (stereo)</b></p> <p>(White)  (Red)  Stereo pin-plug cable</p> <p><b>Analog connections (monaural, for subwoofer)</b></p> <p>(Black)  Pin-plug cable</p> <p><b>Speaker connections</b></p> <p> Speaker cables</p>	<p><b>Component video connections</b></p> <p>(Green)  (Y) (Blue)  (PB/CB) (Red)  (PR/CR) Component video cable</p> <p><b>S-Video connections</b></p> <p> S-Video cable</p> <p><b>Video connections</b></p> <p>(Yellow)  75 Ω/ohms pin-plug video cable</p>
Audio and video cables	
<p><b>HDMI connections</b></p> <p> 19-pin HDMI cable</p>	
Signal direction	
<p>Audio signal:  Video signal: </p>	

## Video Conversion Function

- This function automatically converts various formats of video signals input to the AVR-988 into the format used to output the video signals from the AVR-988 to a monitor.
- The AVR-988's video input/output circuitry is compatible with the following four types of video signals:  
 Digital video signals: HDMI  
 Analog video signals: Component video, S-Video and Video

[Flow of video signals inside the AVR-988]

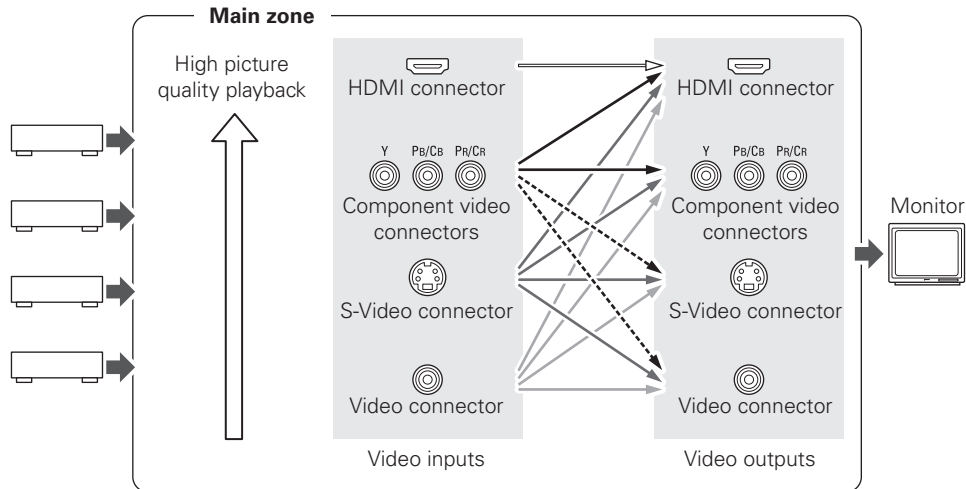

-----: When 480i/576i signals are input in the main zone

[Flow of video signals for ZONE2]

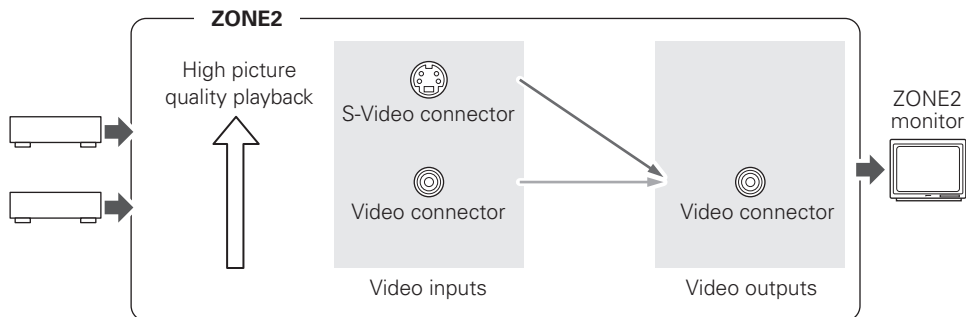

- When not using this function, connect a monitor output with the same type of connector as the video input connector.
- The resolution of the HDMI input-compatible monitor connected to the AVR-988 can be checked at menu "Information" – "HDMI Information" (page 42).

### NOTE

- HDMI signals cannot be converted into analog signals.
- 1080p component input video signals cannot be output to anything other than component video connectors.
- 480p/576p, 1080i and 720p component video input signals cannot be converted into S-Video or Video format.
- When a non-standard video signal from a game machine or some other source is input, the video conversion function might not operate.

## On-Screen Display for Component Video Outputs and HDMI Output

- When viewing HDMI or component video signals via the AVR-988, the on-screen display appears when the **MENU** button is operated.
- When only HDMI or component video signals are input to the AVR-988, the characters of the on-screen display are not displayed over the picture.

## Speaker Connections

### Speaker Installation

The illustration below shows a basic example of installation of the amplifier combined with 8 speakers and a monitor.

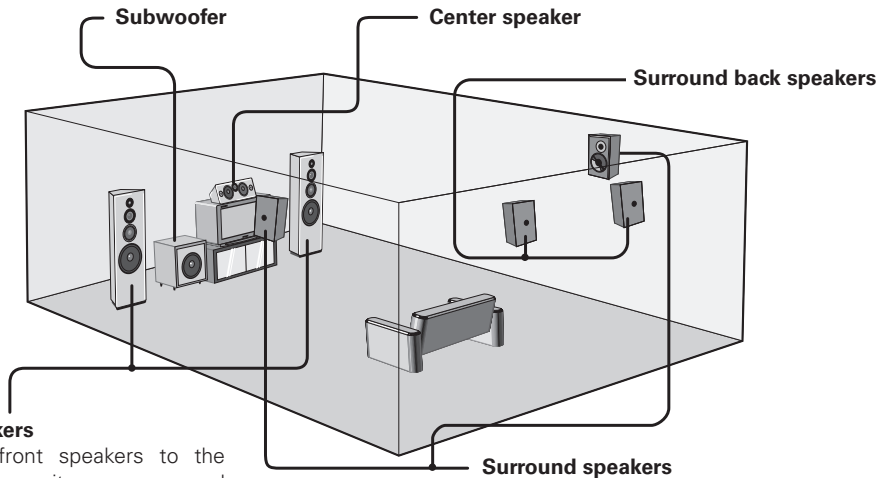

#### Front speakers

Place the front speakers to the sides of the monitor or screen and as flush with the screen surface as possible.



The table below shows a typical speaker configuration for the AVR-988.

	FRONT		CENTER	SURROUND		SURROUND BACK			SUBWOOFER
	L	R		L	R	L	R	1 only	
7.1-channels (FRONT A+B)	○	○	○	○	○	○	○	-	○
7.1-channels	○	○	○	○	○	○	○	-	○
6.1-channels	○	○	○	○	○	-	-	○	○
5.1-channels	○	○	○	○	○	-	-	-	○
3.1-channels	○	○	○	-	-	-	-	-	○
2.1-channels	○	○	-	-	-	-	-	-	○
2-channels	○	○	-	-	-	-	-	-	-

## Speaker Connections

Example: 5.1-channels (FRONT A+B) and ZONE2 use

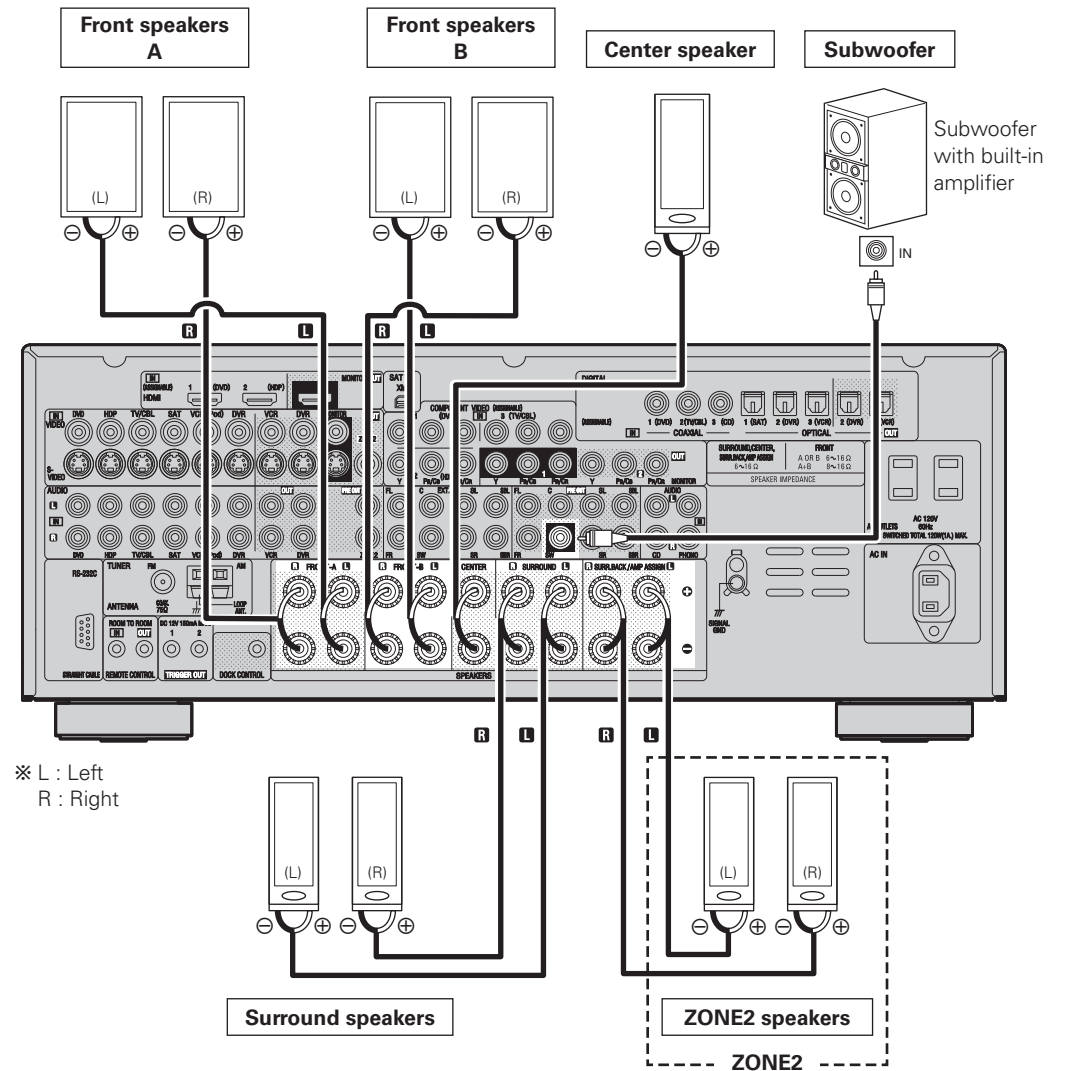

※ L : Left  
R : Right



When using just one surround back speaker, connect it to the left channel (SBL).

#### NOTE

By default, the AVR-988's "Amp Assign" setting is set to "ZONE2". To use as the surround back speaker for the main zone, change the "Amp Assign" setting (page 30).

## Connecting the Speaker Cables

Carefully check the left (L) and right (R) channels and + (red) and – (black) polarities on the speakers being connected to the AVR-988, and be sure to interconnect the channels and polarities correctly.

**1** Peel off about 0.03 ft/10 mm of sheathing from the tip of the speaker cable, then either twist the core wire tightly or terminate it.



**2** Turn the speaker terminal counterclockwise to loosen it.

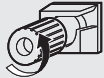

**3** Insert the speaker cable's core wire to the hilt into the speaker terminal.



**4** Turn the speaker terminal clockwise to tighten it.

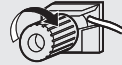

### When using a banana plug

Tighten the speaker terminal firmly before inserting the banana plug.

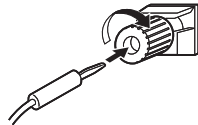

### NOTE

- Use speakers with an impedance of 6 to 16  $\Omega$ /ohms. When using front A and B speakers simultaneously, use speakers with an impedance of 8 to 16  $\Omega$ /ohms.
- Connect the speaker cables in such a way that they do not stick out of the speaker terminals. The protection circuit may be activated if the core wires touch the rear panel or if the + and – sides touch each other (☞ "Protection circuit").
- Never touch the speaker terminals while the power supply is connected. Doing so could result in electric shock.

### Protection circuit

If speakers with an impedance lower than specified (for example 4  $\Omega$ /ohms speakers) are used for an extended period of time with the volume turned up high, the temperature may rise, activating the protection circuit.

When the protection circuit is activated, the speaker output is shut off and the power indicator flashes red. If this happens, unplug the power cord, then check the speaker cable and input cable connections. If the set is extremely hot, wait for it to cool off and improve ventilation around it. Once this is done, plug the power cord back in and turn the set's power back on.

If the protection circuit is activated again even though there are no problems in the ventilation around the set nor in the connections, the set may be damaged. Turn the power off, then contact a DENON service center.

## Connecting Equipment with HDMI connectors

With HDMI connections, the video and audio signals can be transferred with a single cable.

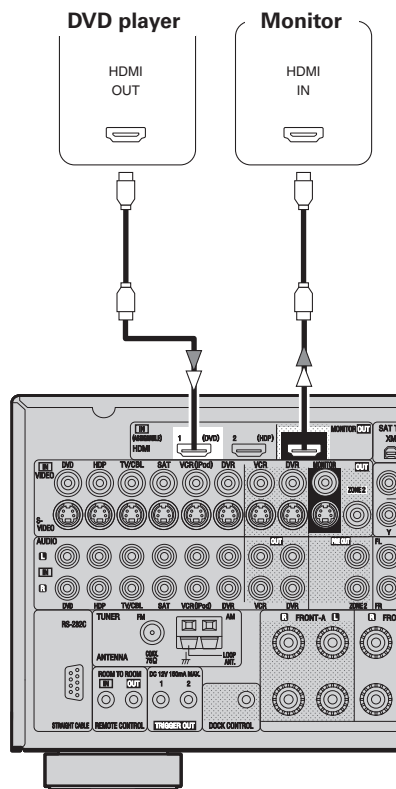

- ※ The AVR-988 is equipped for HDMI version 1.3a. This version is compatible with other versions, allowing connection to all components equipped with an HDMI connector.
- ※ The AVR-988 is compatible with 30- and 36-bit Deep Color.

Compatible audio format	Details	Discs (examples)
2-channel linear PCM	2ch 32-192 kHz 16/20/24 bits	CD, DVD-Video, DVD-Audio
Multi-channel linear PCM	8ch 32-192 kHz 16/20/24 bits	DVD-Audio
Dolby Digital, DTS	Bitstream	DVD-Video
DSD	2/5.1ch 2.8224 MHz 1 bit	SACD
Dolby Digital Plus, Dolby TrueHD, DTS-HD	Bitstream	HD DVD, Blu-ray Disc

### Copyright protection system (HDCP)

In order to play the digital video and audio signals of a DVD-Video or DVD-Audio disc using HDMI/DVI connections, both the connected DVD player and monitor must be equipped for a copyright protection system called "HDCP" (High-bandwidth Digital Content Protection). HDCP is a copy protection technology consisting of data encoding and mutual identification of the devices. The AVR-988 is HDCP-compatible. For details on the DVD player or monitor you are using, refer to its operating instructions.



- By default, the HDMI audio signals are output from the speakers connected to the AVR-988.
- To output the sound from the TV, make the settings at menu "Manual Setup" – "HDMI Setup" – "HDMI Audio Setup" – "TV" (page 27).

### NOTE

- Use a CPPM-compatible DVD player to play DVD-Audio discs that are copyright-protected by CPPM.
- The AVR-988 cannot be controlled from another device via the HDMI cable.
- The audio signals output from the HDMI connector (sampling frequency, bit rate, etc.) may be restricted by the connected device.
- Video signals are not output properly when using devices that are not HDCP-compatible.
- Video signals are not output if the input video signals do not match the monitor's resolution. In this case, switch the DVD player's resolution to a resolution with which the monitor is compatible.
- If the menu "Manual Setup" – "HDMI Setup" – "HDMI Audio Setup" setting (page 27) is set to "AMP," the sound may be interrupted when the monitor's power is turned off.
- Use a cable on which the HDMI logo is indicated (a certified HDMI product) for connection to the HDMI connector. Normal playback may not be possible when using a cable other than one on which the HDMI logo is indicated (a non-HDMI-certified product).
- If the monitor or DVD player does not support deep color, deep color signal transfer is not possible.
- If the monitor or DVD player does not support xvYCC, xvYCC signal transfer is not possible.
- If the monitor does not support "Auto Lipsync Correction" function, this function will not work.



- When the AVR-988 and DVD player are connected using an HDMI cable, also connect the AVR-988 and monitor using an HDMI cable.
- If the connected monitor or DVD player only has a DVI-D connector, use an HDMI/DVI converter cable. When using a DVI cable, no audio signals are transmitted.
- Use a Deep Color compatible cable for connection to Deep Color compatible devices.

### When connecting with an HDMI/DVI converter cable (adapter)

- HDMI video signals are theoretically compatible with the DVI format. When connecting to a monitor, etc., equipped with a DVI-D connector, connection is possible using an HDMI/DVI converter cable, but depending on the combination of components in some cases the video signals will not be output.
- When connecting using an HDMI/DVI converter adapter, the video signals may not be output properly due to poor connections with the connected cable, etc.

## Connecting the Monitor

- Connect the cables to be used (☞ page 8 “Video Conversion Function”).
- With HDMI connections, the video and audio signals can be transferred with a single cable.
- To output the audio signals to the monitor with HDMI connections, set menu “Manual Setup” – “HDMI Setup” – “HDMI Audio Setup” to “TV” (☞ page 27).

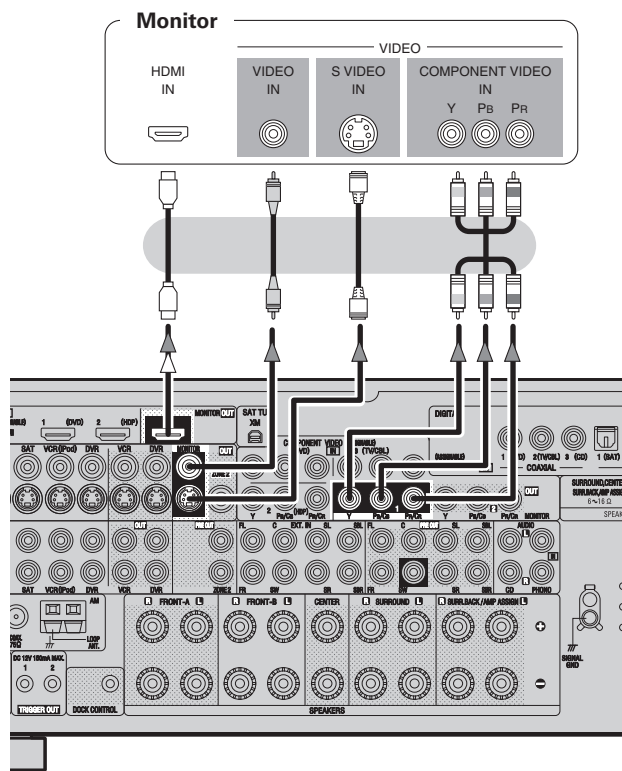

### NOTE

- The component video connectors may be indicated differently on your monitor. For details, see the monitor's operating instructions.
- The audio signals output from the HDMI connectors are only the HDMI input signals.

## Connecting the Playback Components

Carefully check the left (L) and right (R) channels and the inputs and outputs, and be sure to interconnect correctly.

### DVD Player

- Connect the cables to be used.
- With HDMI connections, the video and audio signals can be transferred with a single cable.

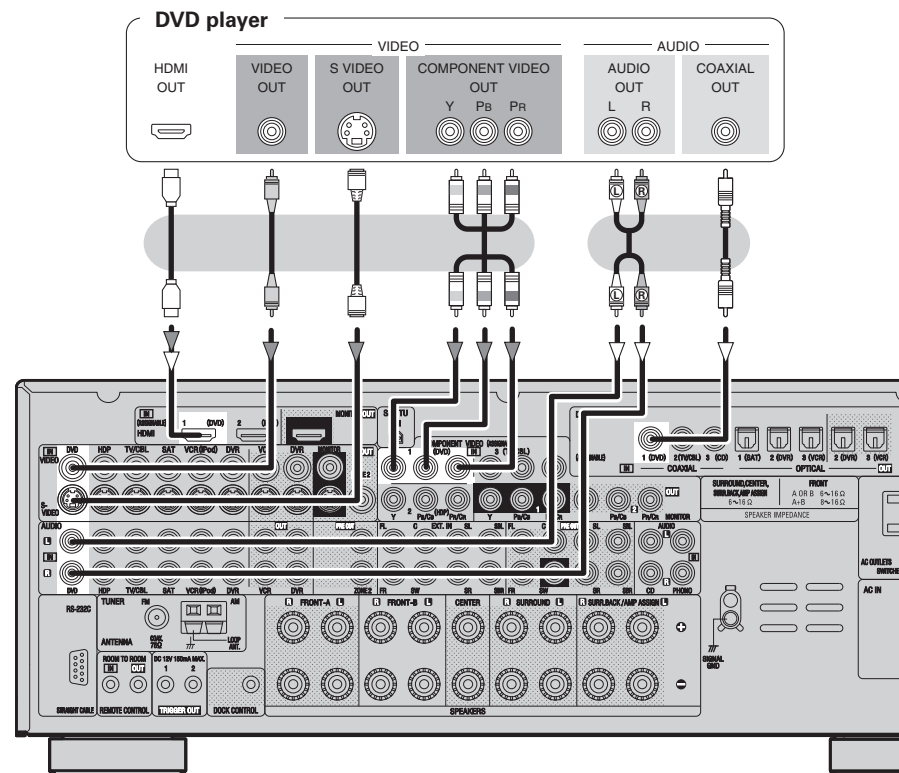

- Connect an HDP (High-Definition Player) in the same way.
- When using an optical cable for the digital audio connection, make the settings at menu “Input Setup” – “Assign” – “Digital In” (☞ page 35).

## Record Player

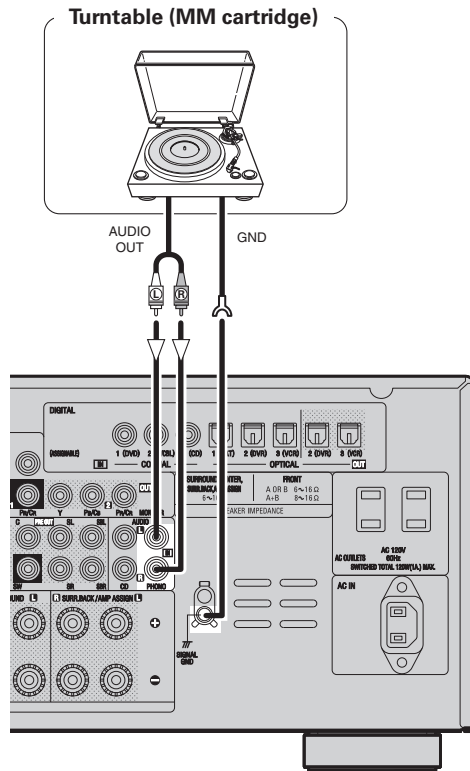

- When connecting a record player with an MC cartridge, use a commercially available MC head amplifier or a step-up transformer.
- Induction humming (a booming sound) may be produced from the speakers if the volume is raised with no record player connected.
- With some record players, noise may be generated when the ground wire is connected. If so, disconnect the ground wire.

### NOTE

The AVR-988's SIGNAL GND terminal is meant to reduce noise when a record player is connected. This is not a safety ground terminal.

## CD Player

Connect the cables to be used.

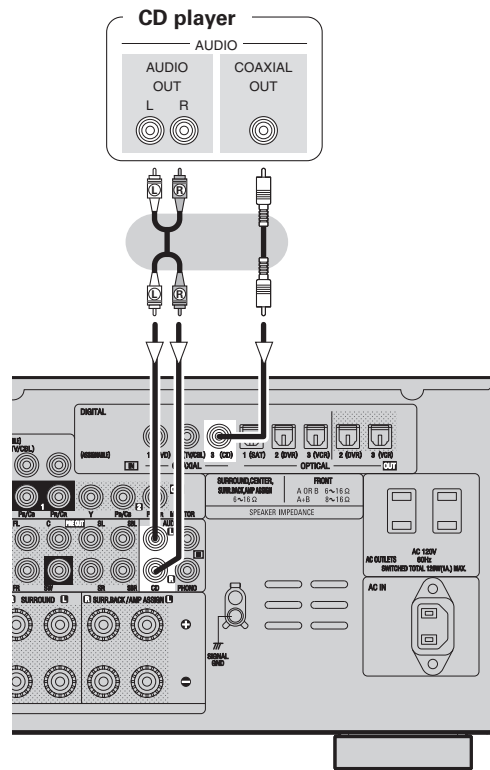

When using an optical cable for the digital audio connection, make the settings at menu "Input Setup" – "Assign" – "Digital In" (page 35).



## iPod®

Use a DENON Control Dock for iPod (ASD-1R, sold separately) to connect the iPod to the AVR-988. For instructions on the Control Dock for iPod settings, refer to the Control Dock for iPod's operating instructions.

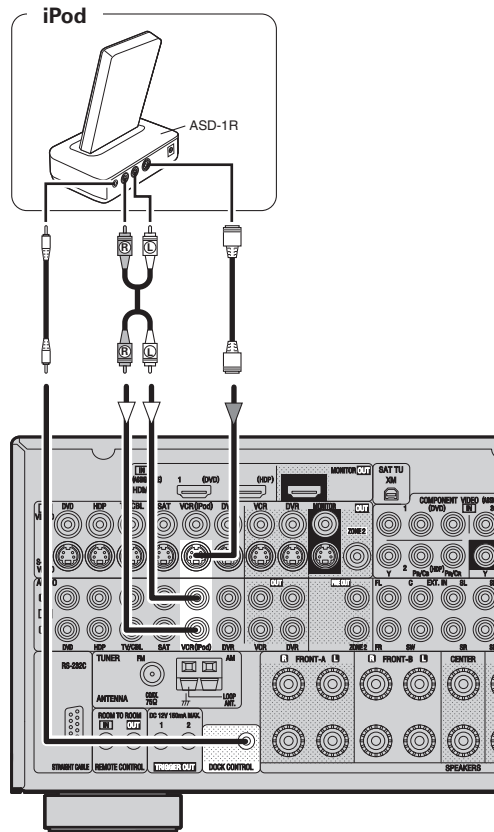

## TV/CABLE Tuner

Connect the cables to be used.

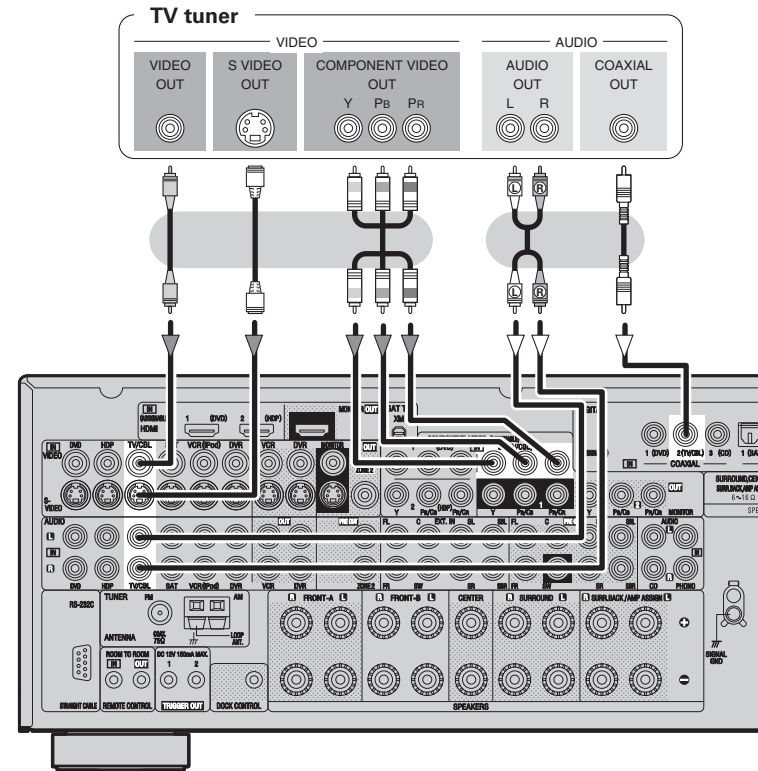

When using an optical cable for the digital audio connection, make the settings at menu "Input Setup" – "Assign" – "Digital In" (page 35).



- With the default settings, the iPod can be used connected to the VCR (iPod) connector.
- To assign the iPod to a connector other than VCR (iPod), make the settings at menu "Input Setup" – "(input source to which iPod dock assigned)" – "Assign" – "iPod dock" (page 35).

## Satellite Receiver

Connect the cables to be used.

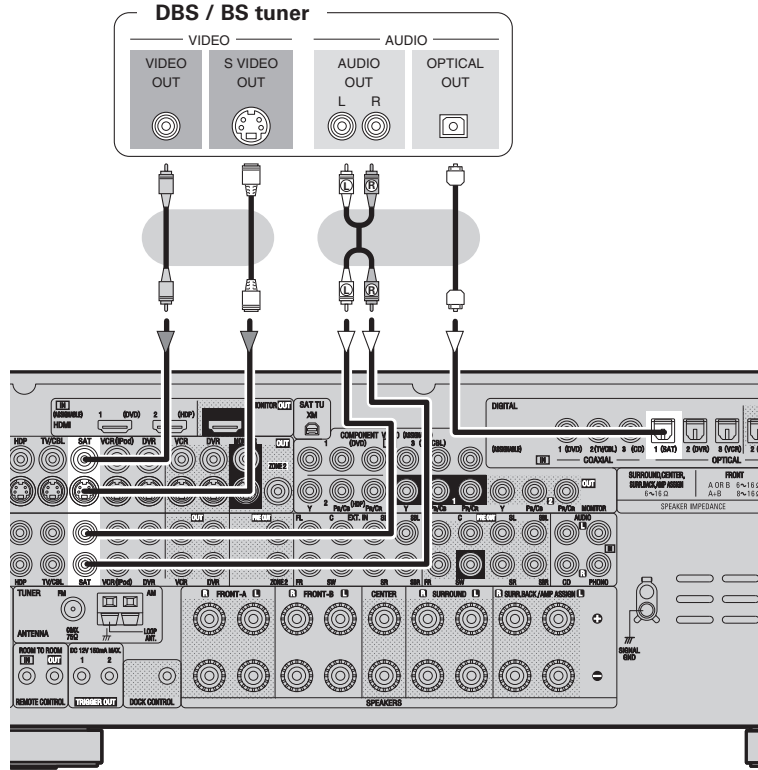

- When using a coaxial digital cable for the digital audio connection, make the settings at menu "Input Setup" – "Assign" – "Digital In" (page 35).
- When using a component video cable for the video connection, make the settings at menu "Input Setup" – "Assign" – "Component In" (page 35).

## Connecting the Recording Components

Carefully check the left (L) and right (R) channels and the inputs and outputs, and be sure to interconnect correctly.

## Digital Video Recorder

Connect the cables to be used.

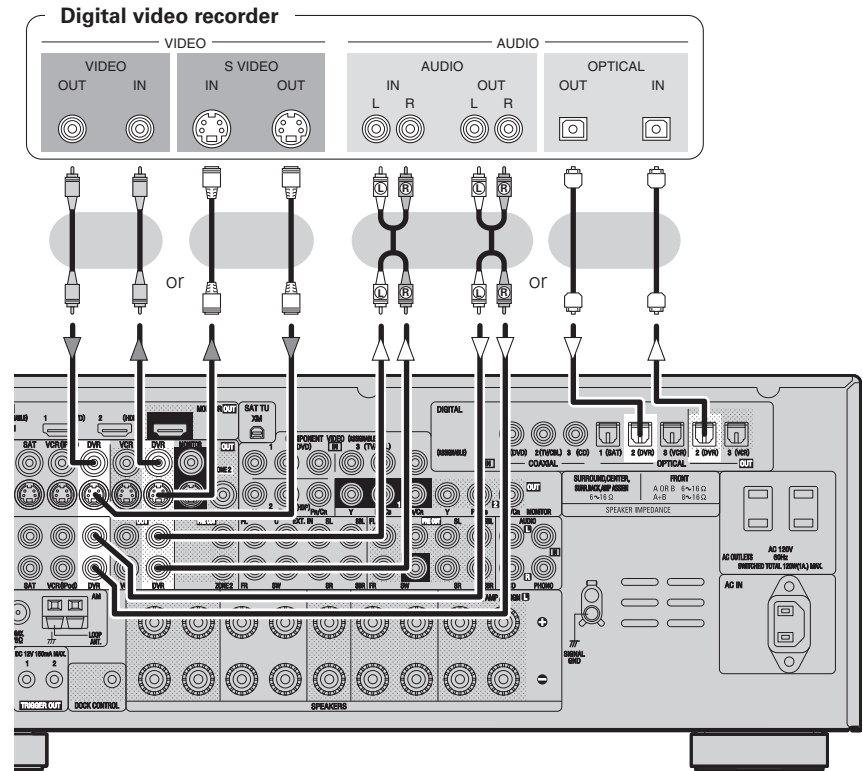

- Make analog connections if you wish to record analog audio signals.
- When recording via the AVR-988, the playback device's cable must be of the same type as the cable used to connect the AVR-988's DVR OUT connector.  
**Example:** TV IN → S-Video cable : DVR OUT → S-Video cable  
TV IN → Video cable : DVR OUT → Video cable
- When using a component video cable for the video connection, make the settings at menu "Input Setup" – "Assign" – "Component In" (page 35).

### NOTE

Do not connect the output of the component connected to the AVR-988's OPTICAL2 output connector to any input connector other than OPTICAL2.

## Video Cassette Recorder

Connect the cables to be used.

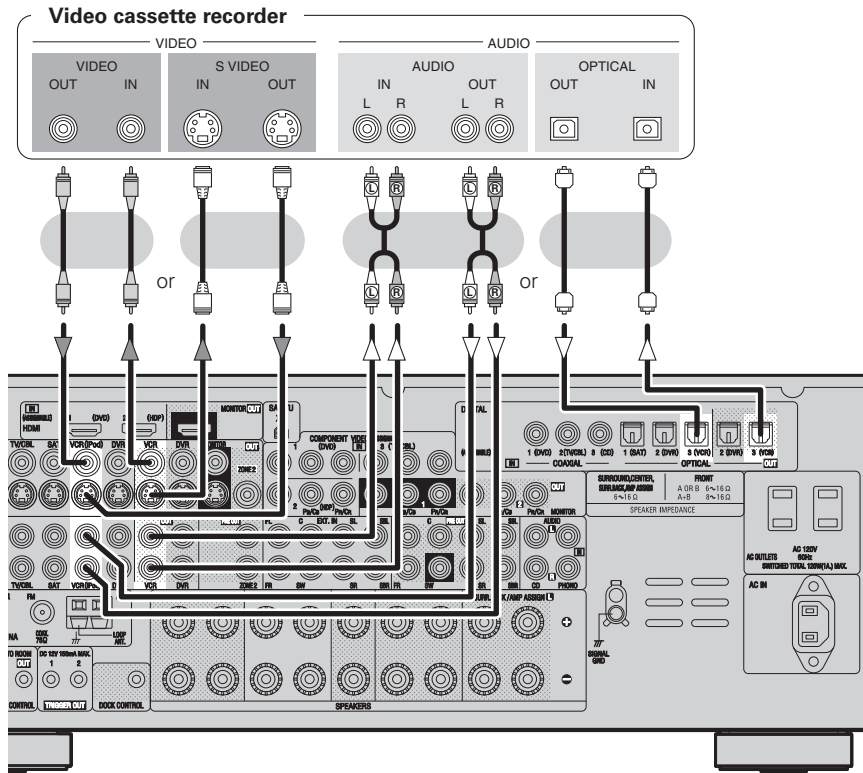

- When recording via the AVR-988, the playback device's cable must be of the same type as the cable used to connect the AVR-988's VCR OUT connector.

**Example:** TV IN → S-Video cable : VCR OUT → S-Video cable  
TV IN → Video cable : VCR OUT → Video cable

- When using a component video cable for the video connection, make the settings at menu "Input Setup" – "Assign" – "Component In" (page 35).

### NOTE

Do not connect the output of the component connected to the AVR-988's OPTICAL3 output connector to any input connector other than OPTICAL3.

## CD Recorder / MD Recorder / Tape Deck

Make analog connections if you wish to record analog audio signals, or digital connections if you wish to record digital audio signals, depending on the types of connectors on the components being used.

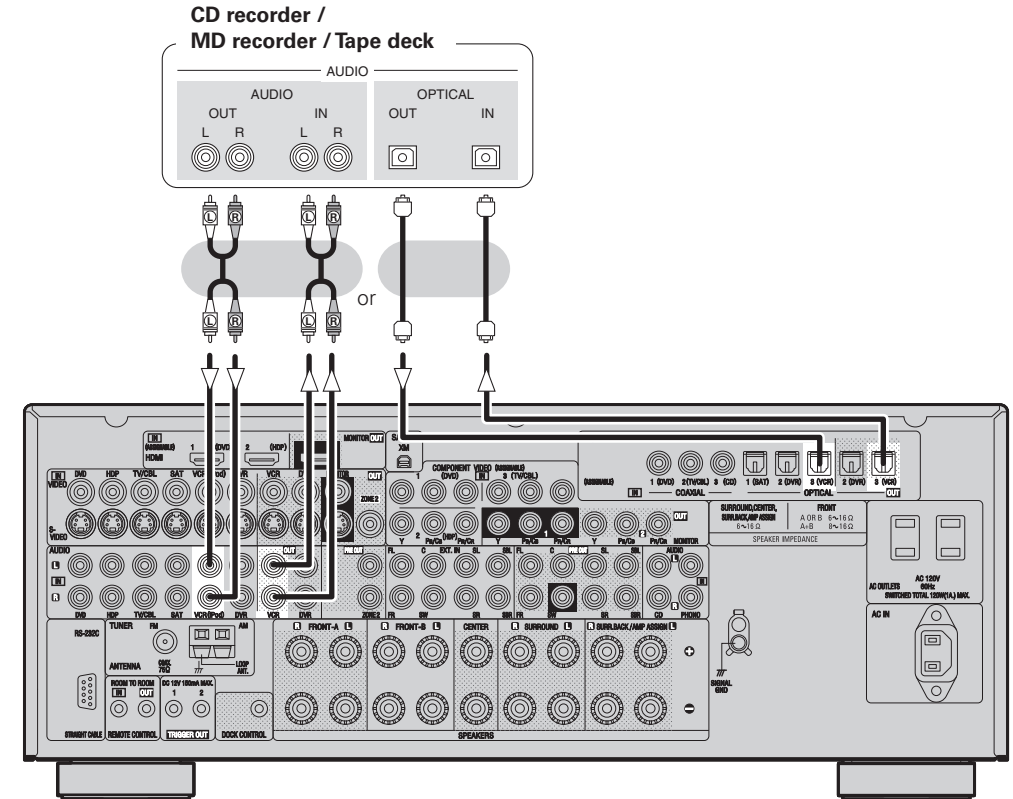

### NOTE

Do not connect the output of the component connected to the AVR-988's OPTICAL3 output connector to any input connector other than OPTICAL3.

## Connections to Other Devices

Carefully check the left (L) and right (R) channels and the inputs and outputs, and be sure to interconnect correctly.

### Video Camera / Game Console

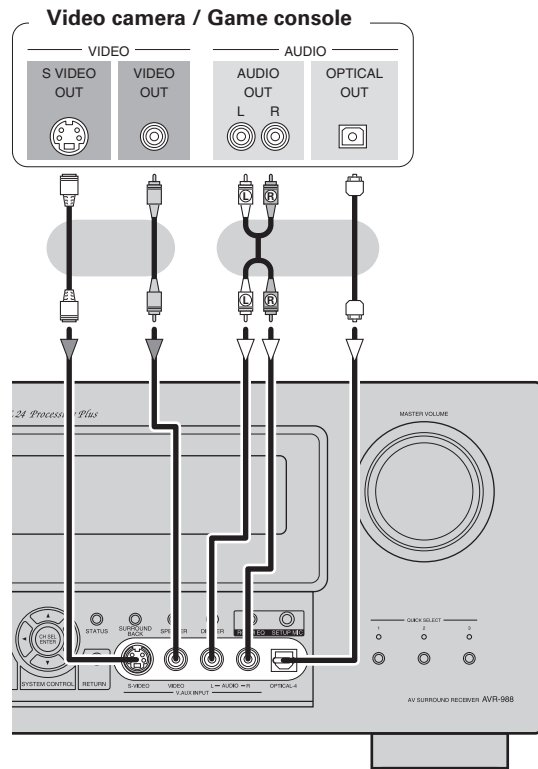

### Component with Multi-channel Output connectors

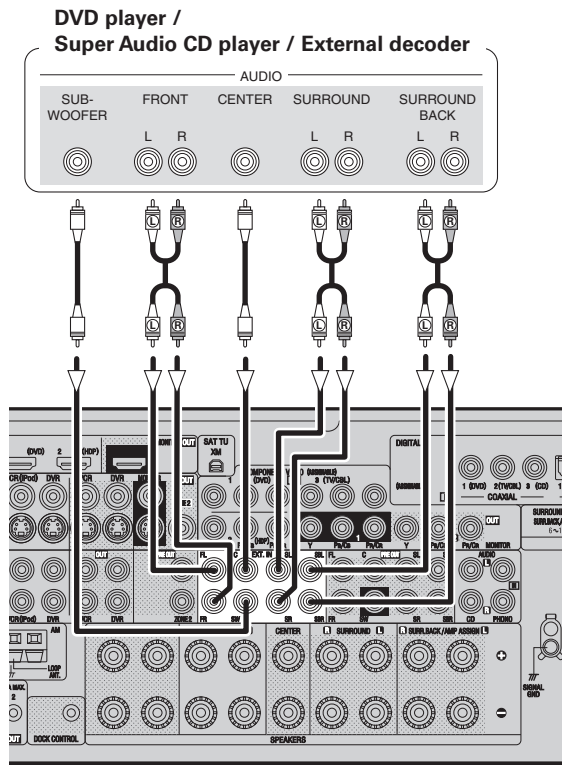

- To play the analog input signals input to the EXT. IN connectors, press the **INPUT MODE** button on the main unit or **INPUT** button on the remote control unit and select "EXT. IN" or make the settings at menu "Input Setup" – "Input Mode" – "Input Mode" – "EXT. IN" (☞ page 34).
- The video signal can be connected in the same way as a DVD player (☞ page 12).
- To play copyright-protected discs, connect the AVR-988's EXT. IN connector with the DVD player's analog multi-channel output connector.

### External Power Amplifier

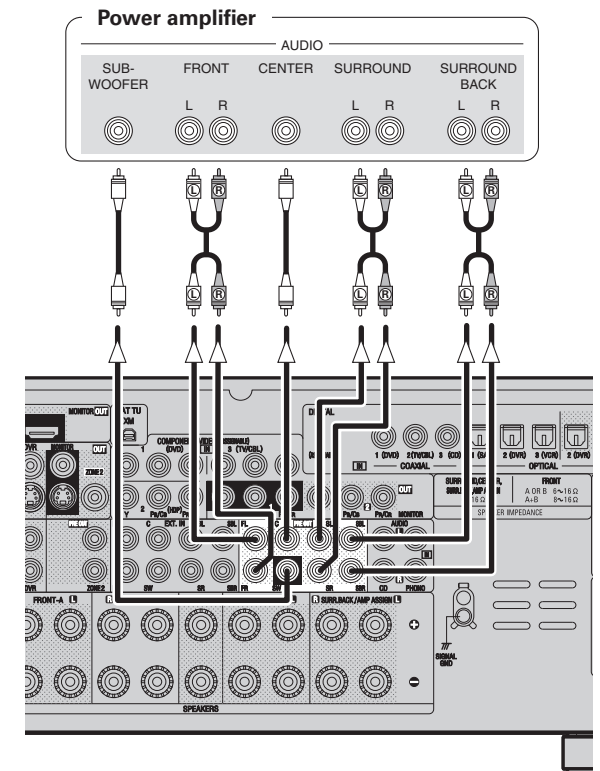

When using just one surround back speaker, connect it to the left channel (SBL).

## XM connector

- The AVR-988 is an XM Ready® receiver. You can receive XM® Satellite Radio by connecting to the XM Mini-Tuner and Home Dock (includes home antenna, sold separately) and subscribing to the XM service.
- Plug the XM Mini-Tuner and Home Dock into the XM connector on the rear panel.
- Position the Home Dock antenna near a south-facing window to receive the best signal.

For details, see "Listening to XM Satellite Radio Programs" (page 45, 46).

When making connections, also refer to the operating instructions of the XM Mini-Tuner and Home Dock.

### XM Mini-Tuner and Home Dock

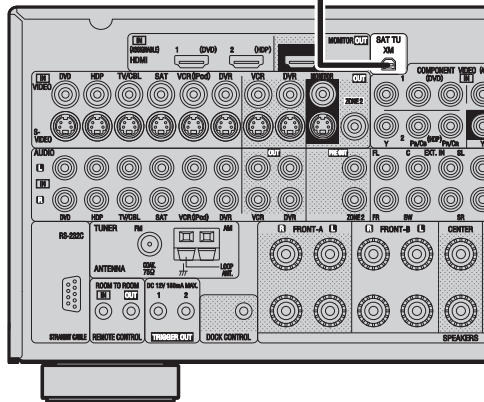
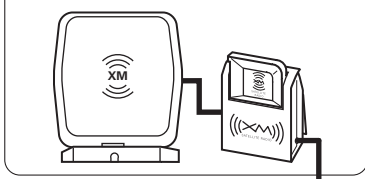

### NOTE

Keep the power cord unplugged until the XM Mini-Tuner and Home Dock connection have been completed.

- The XM name and related logo are registered trademarks of XM Satellite Radio Inc. All rights reserved.
- XM Ready is a registered trademark of XM Satellite Radio Inc. All rights reserved.

## Antenna terminals

An F-type FM antenna cable plug can be connected directly.

Direction of broadcasting station

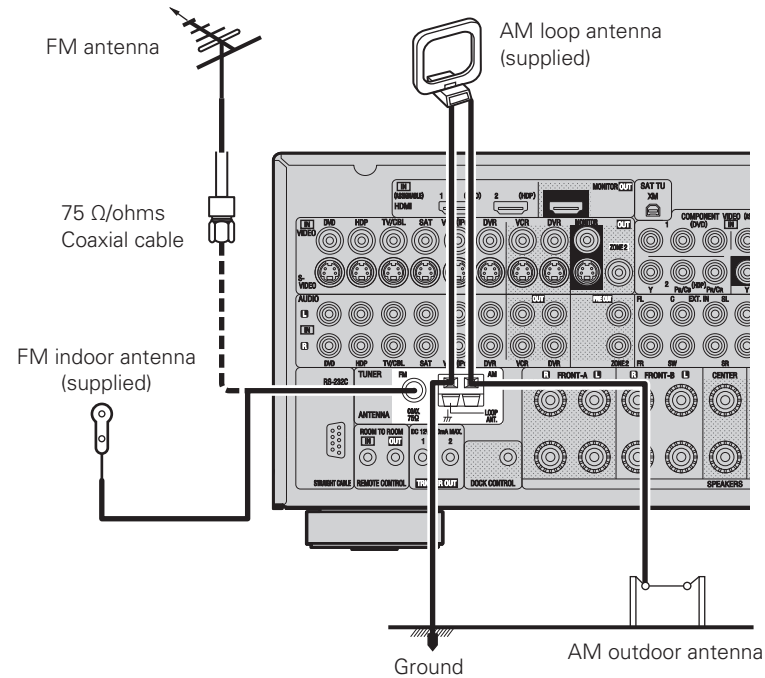

### AM loop antenna assembly

- Remove the vinyl tie and take out the connection line.
- Connect to the AM antenna terminals. Bend in the reverse direction.
- Mount
  - With the antenna on top of any stable surface.
  - With the antenna attached to a wall.

### Connection of AM antennas

- Push the lever.
- Insert the conductor.
- Return the lever.



### NOTE

- Do not connect two FM antennas simultaneously.
- Even if an external AM antenna is used, do not disconnect the AM loop antenna.
- Make sure the AM loop antenna lead terminals do not touch metal parts of the panel.

### Note to CATV system installer:

This reminder is provided to call the CATV system installer's attention to Article 820-40 of the NEC which provides guidelines for proper grounding and, in particular, specifies that the cable ground shall be connected to the grounding system of the building, as close to the point of cable entry as practical.

## Multi-zone

### ZONE2 Pre-out Connections

- If another power amplifier or pre-main (integrated) amplifier is connected, the ZONE2 pre-out (variable or fixed level) connectors can be used to play a different program source in ZONE2 the same time (page 55 ~ 58).
- When using an S-Video cable or a video cable for connection between the AVR-988 and an input device, connect to the video connectors.

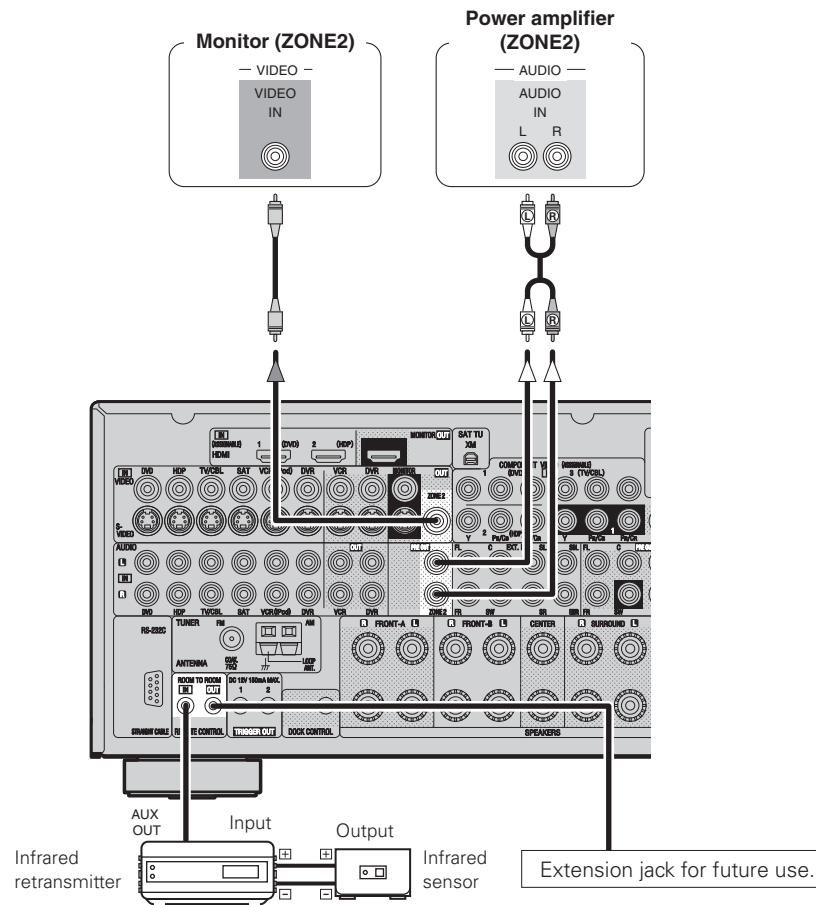

#### NOTE

- For the audio output, use high quality pin-plug cords so that no induction humming or noise is produced.
- For instructions on installing and operating separately sold devices, refer to the respective devices' operating instructions.
- To conduct multi-zone playback, see "Amp Assign / Multi-zone Connections and Operations" (page 55 ~ 58).

## External Controller

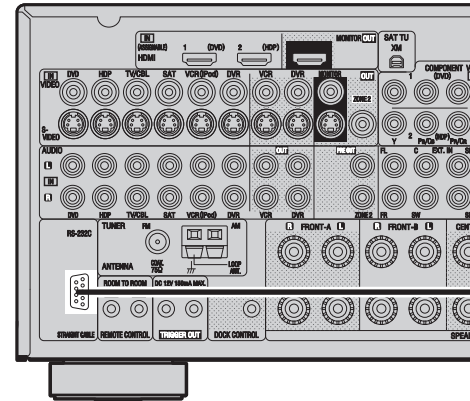

### RS-232C connector

This connector is used for an external controller.

※ If you wish to control the AVR-988 from an external controller using the RS-232C connector, perform the operation below beforehand.

- ① Turn on the AVR-988's power.
- ② Turn off the AVR-988's power from the external controller.
- ③ Check that the AVR-988 is in the standby mode.



- When using in combination with an RF Remote Controller (RC-7000CI, sold separately) or RF Remote Receiver (RC-7001RCI, sold separately) two-way communication with an RF Remote Controller is possible.

The AVR-988's status information as well as iPod can be browsed watching the RF Remote Controller's display. For details, refer to the operating instructions of the respective devices.

- When used in combination with an RF Remote Controller or RF Remote Receiver, make the settings at menu "Manual Setup" – "Option Setup" – "2Way Remote" – "Used" (page 32).

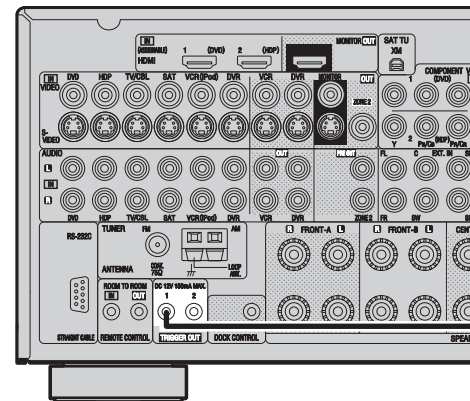

### Trigger output jacks

The power of an external device equipped with a trigger input jack can be turned on and off in association with operations on the AVR-988. For details, see menu "Manual Setup" – "Option Setup" – "Trigger Out" (page 32).

- Output: DC 12 V 150 mA MAX.  
Check the trigger input conditions of the connected device.

## Connecting the Power Cord

Wait until all connections have been completed before connecting the power cord.

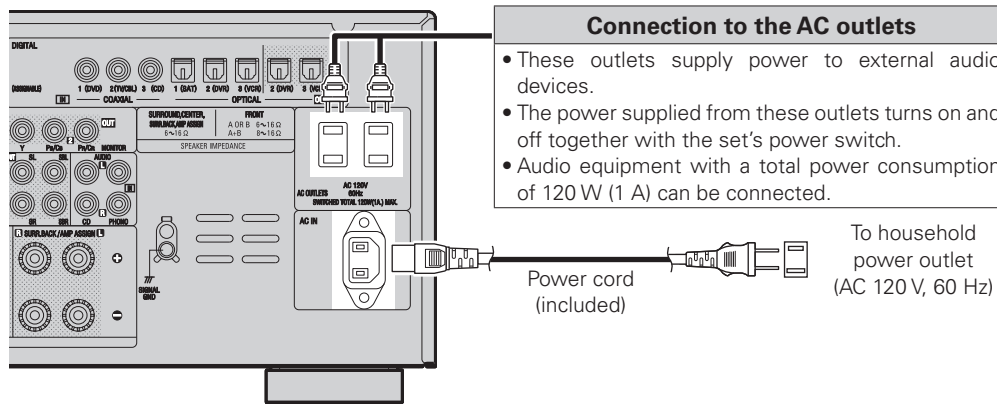

### Connection to the AC outlets

- These outlets supply power to external audio devices.
- The power supplied from these outlets turns on and off together with the set's power switch.
- Audio equipment with a total power consumption of 120 W (1 A) can be connected.

To household power outlet (AC 120 V, 60 Hz)

Power cord (included)

### NOTE

- Insert the AC plugs securely. Incomplete connections could cause noise.
- Only use the AC outlets to plug in audio devices. Do not use them as power supplies for hairdryers or anything other than audio equipment.

## Once Connections are Completed

Turning the Power On (page 43)

## Menu Operations

With the AVR-988, settings and operations for most functions can be performed by operating while looking at the menus displayed on the monitor screen.

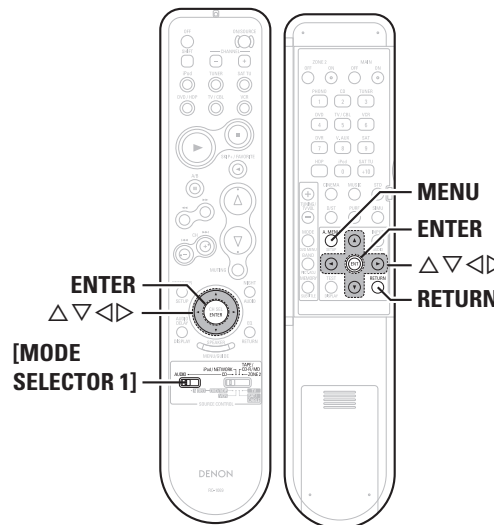
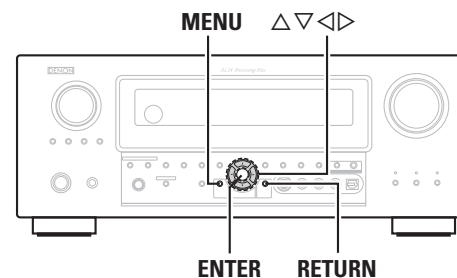

## Operations

The same operation is possible on the main unit or remote control unit.

### 1 Press MENU.

The menu is displayed.

※ To operate from the remote control unit, be sure to set the **[MODE SELECTOR 1]** to "AUDIO".

### 2 Press $\Delta \nabla$ to select the item you want to set, then press ENTER.

### 3 Press $\Delta \nabla$ again to select the item you want to set, then press ENTER.

### 4 To change the setting: Press $\Delta \nabla$ to select the item you want to change, then press $\triangleleft \triangleright$ to change the setting.

※ To return to the previous item, press RETURN.

※ Select "Default Yes", then press  $\triangleleft$  to reset to the default setting.

### 5 Press ENTER to enter the setting.

### 6 Press MENU to finish.

### About the button names in these explanations

$\triangleleft \triangleright$  : Buttons on the main unit

[ ] : Buttons on the remote control unit

### Button name only:

Buttons on the main unit and remote control unit



When **MENU** is pressed, the settings made up to that point are entered and the settings menu screen turns off.

## Example of Display of Default Values

In lists of selectable items or adjustable ranges, the item surrounded by a border is the default value.

[Selectable items] **A** B A + B

## Examples of On-screen Display and Front Display

Some typical examples are described below.

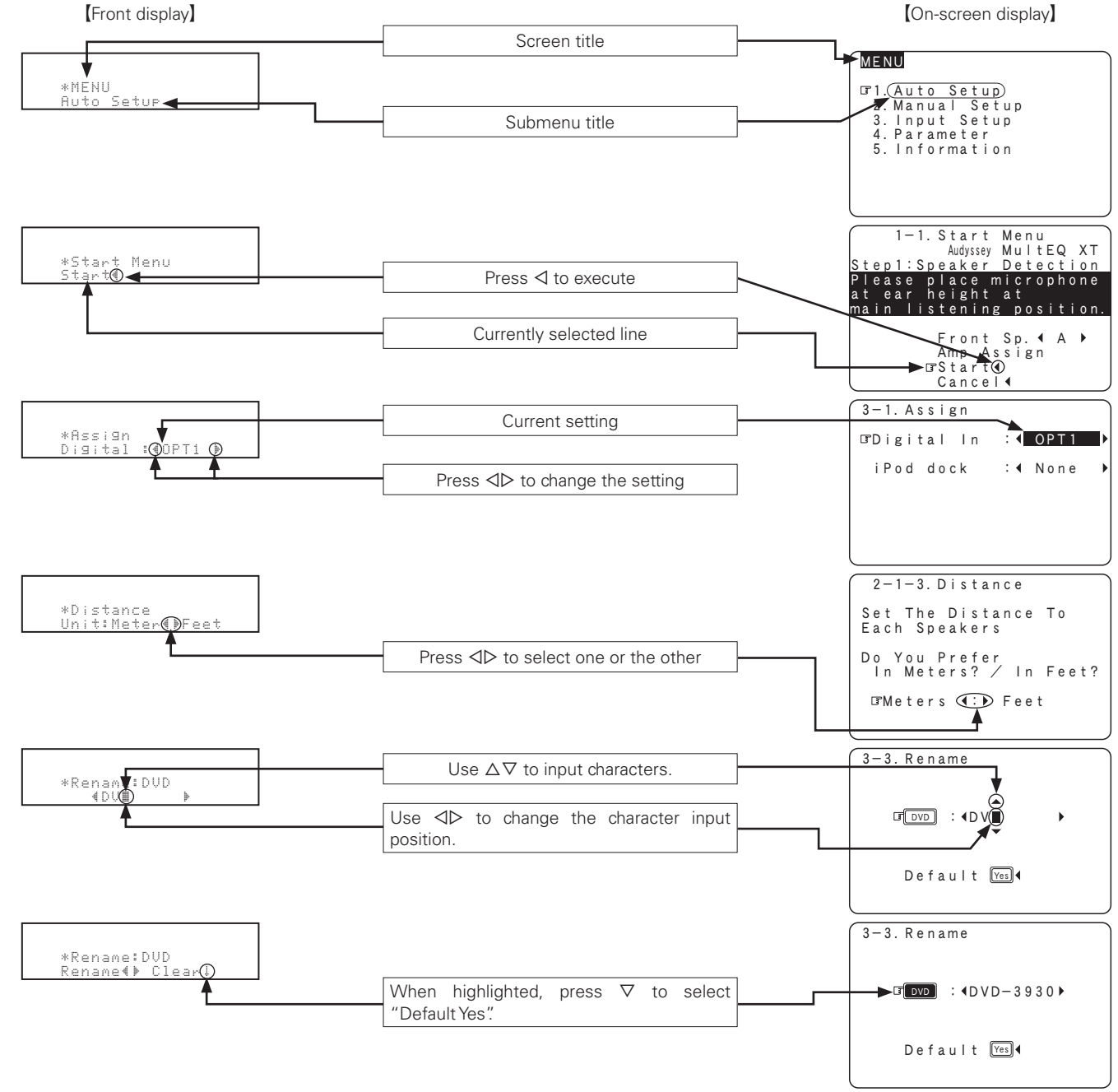



# Menu Map

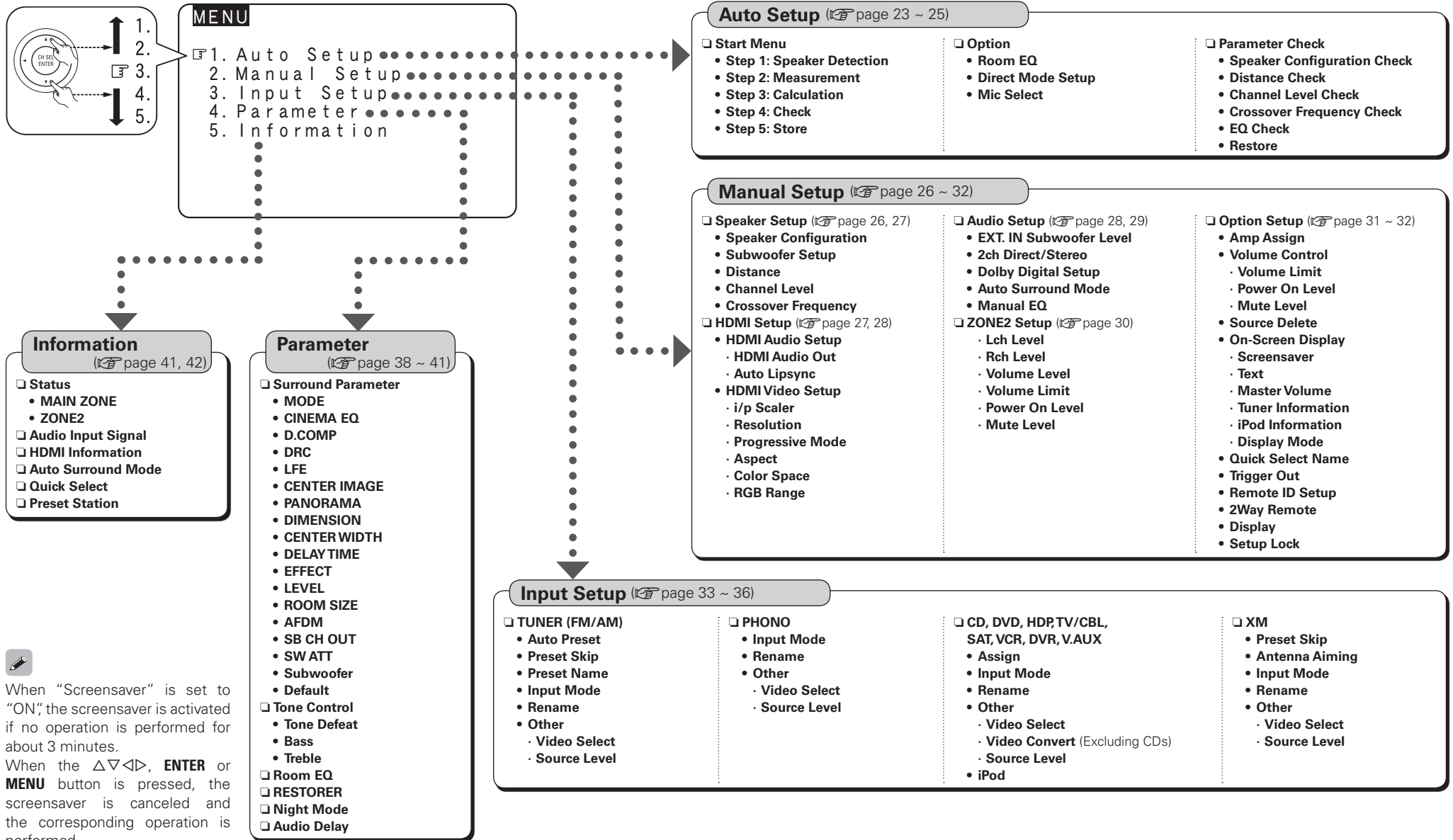

When "Screensaver" is set to "ON", the screensaver is activated if no operation is performed for about 3 minutes.

When the  $\Delta \nabla \leftarrow \rightarrow$ , **ENTER** or **MENU** button is pressed, the screensaver is canceled and the corresponding operation is performed.

# Auto Setup

- Audyssey MultEQ® XT automatically measures the acoustical problems in the listening environment to create the best audio experience for your home theater.
- It optimizes a large listening area where one or more listeners are seated.

Measurements are performed by placing the calibrated microphone (DM-A405) successively at multiple positions throughout the listening area as shown in **Example ①**. For best results, it is strongly recommended to measure 6 or more positions so that the measurements have the proper spatial weighting.

Even if the listening environment is small as shown in **Example ②**, measuring at multiple points throughout the listening environment results in more effective correction.

**Example ①**

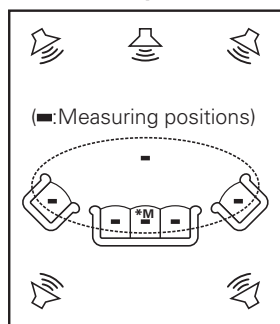

**Example ②**

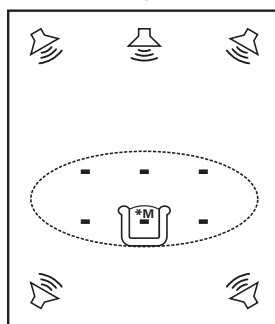

## About the main listening position (\*M)

The main listening position refers to the most central position where one would normally sit within the listening environment.

MultEQ XT uses the measurements from this position to calculate speaker distance, level, polarity, and the optimum crossover value for the subwoofer.



To make manual adjustments to the settings, see pages 26, 27.

## Preparations

### 1 Connect the included calibrated setup microphone to the SETUP MIC jack on the main unit.

The auto setup screen appears automatically.

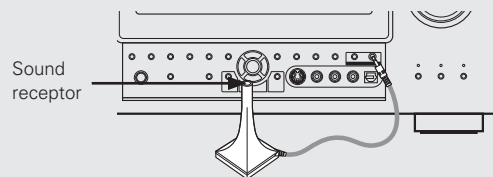

### 2 Place the microphone at ear height on a tripod or stand with the microphone pointing directly up towards the ceiling.

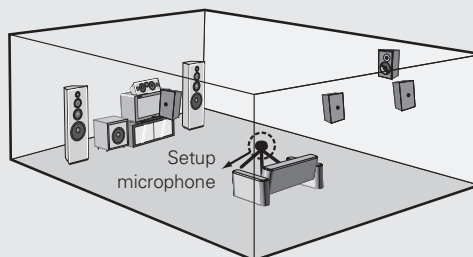

※ It is not recommended to hold it in your hand. Be sure that the path from microphone to the speakers is not blocked by objects. Avoid placing the microphone close to a seat back or wall as sound reflections may give inaccurate results.



When using a subwoofer, make the following settings before starting the auto setup procedure:

- Defeat the volume and crossover controls if possible
- If this is not possible then set
  - Volume: "12 o'clock" position
  - Crossover frequency: "Maximum/Highest Frequency"
  - Low pass filter: "Off"
  - Standby mode: "Off"

### NOTE

- Do not disconnect the setup microphone until the auto setup procedure is completed.
- When using headphones, unplug the headphones before starting the auto setup procedure.

## Auto Setup

Optimize settings for speakers in use.

### ● Menu screen ●

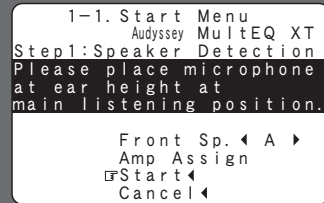

### 1 Start Menu

The settings are performed automatically.

### Start

Start Auto Setup.

The Audyssey MultEQ XT Auto Setup process automatically calculates the size, level, distance, bass management crossover frequency, and optimal settings for each speaker and subwoofer. Audyssey MultEQ XT corrects acoustical distortions within the listening area.

Before starting, connect and position all your speakers.

Once started, MultEQ XT will play a series of test tones through each speaker.



If an error message appears during the measurements, check "Error Messages"; take the advised action, then start the measurements again (page 25).

### Front Speaker

The front speaker to be measured can be selected ahead of time here.

#### [Selectable items]

**A** : Output test tone from front speakers A.

**B** : Output test tone from front speakers B.

**A + B** : Output test tone from front speakers A and B.

### Amp Assign

Advanced setting : changes power amplifier assignment.

For details, refer to "Amp Assign" (page 30).

### Step 1 : Speaker Detection

The speaker connection and polarity are detected at the first measurement position. The following attributes are also determined at this time: "Speaker Size", "Speaker Distance", "Channel Level", "Crossover Frequency".

Once the measurements are completed, the results are displayed.

#### NOTE

- Loud test tone may be played during Audyssey MultEQ XT Automatic Speaker Setup. This is part of normal operation. If there is background noise in room, these test tones will increase in volume.
- Do not stand between the speakers and setup microphone or allow obstacles in the path while the measurements are being made. This will cause inaccurate readings.
- Quiet the listening environment before beginning measurements and refrain from talking. Turn off air conditioning units or other devices that emit noise if at all possible as measurements may be affected by these sounds.
- Operating the **MASTER VOLUME** knob on the main unit or the **MASTER VOLUME** buttons on the remote control unit during the measurements will cancel the measurements.
- Do not change the speaker connections or subwoofer volume after "Step 1".

### Step 2 : Measurement

After completing a measurement position, move the microphone to the next position.



Measure at least 6 positions (main listening position and at least 5 other surrounding positions). For best results it is recommend measuring **6 or more positions** (with a maximum of 8 positions).

### Step 3 : Calculation

When "Calculate" is selected at "Step2", the measurements taken are analyzed automatically to determine how the speaker system interacts with the room.



The time required for this analysis depends on the number of speakers connected. The higher the number of speakers, the longer the time required for analysis.

### Step 4 : Check

Once the auto setup procedure is complete, a measuring result check screen appears.

Select any item whose results you want to check to review the results.



Values that are different from the actual distance may be set for speakers with built-in filters (subwoofers, etc.). This is because filters add electrical delay to the signal that should be compensated.

### Step 5 : Store

The auto setup measurement results are stored in the AVR-988.

#### NOTE

Do not turn the power off while the settings are being stored.

## Error Messages

If the auto setup procedure could not be completed due to speaker installation, the measuring environment, etc., an error message is displayed. If this happens, check the relevant items, be sure to take the necessary measures, then perform the auto setup procedure over again.

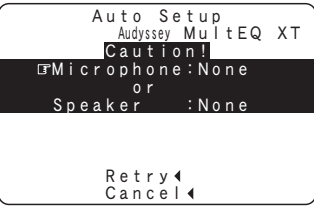
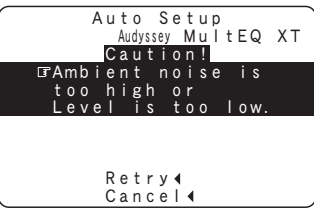
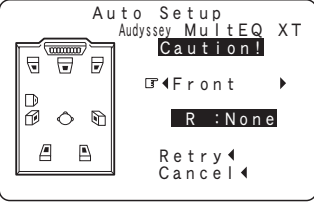
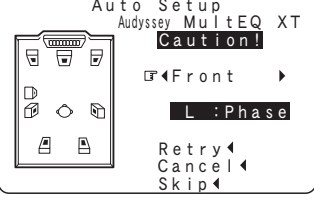
Error messages (examples)	Cause	Measures
	<ul style="list-style-type: none"> <li>Included setup microphone is not connected.</li> <li>Not all speakers could be detected.</li> </ul>	<ul style="list-style-type: none"> <li>Connect the included setup microphone to the <b>SETUP MIC</b> jack on the main unit.</li> <li>Check the speaker connections.</li> </ul>
	<ul style="list-style-type: none"> <li>Too much noise in the room for accurate measurements to be made.</li> <li>Speaker or subwoofer sound is too low for accurate measurements to be made.</li> </ul>	<ul style="list-style-type: none"> <li>Either turn off any device generating noise or move it away.</li> <li>Try again when the surroundings are quieter.</li> <li>Check the speaker installation and the direction in which the speakers are facing.</li> <li>Adjust the subwoofer's volume.</li> </ul>
	<ul style="list-style-type: none"> <li>Displayed speaker could not be detected.               <ul style="list-style-type: none"> <li>The front L and front R speakers were not properly detected.</li> <li>Only one channel of the surround speakers was detected.</li> <li>Sound was output from the R channel when only one surround back speaker was connected.</li> <li>The surround back, but the surround speaker was not detected.</li> </ul> </li> </ul>	<ul style="list-style-type: none"> <li>Check the connections of the displayed speaker.</li> </ul>
	<ul style="list-style-type: none"> <li>Displayed speaker connected with the polarities reversed.</li> </ul>	<ul style="list-style-type: none"> <li>Check the polarities of the displayed speaker.</li> <li>For some speakers, this error message may be displayed even if the speaker is properly connected. If you are sure that the wiring is correct, select "Skip".</li> </ul>

 Select "Retry" to make the measurements again.

**NOTE** Be sure to turn the power off before checking the speaker connections.

## 2 Option

Select settings for room EQ, mic, etc.

### Room EQ

Select room EQ setting method.

#### [Selectable items]

**All** : Apply settings to all surround modes.

**Assign** : Make settings for each surround mode separately.

### Direct Mode Setup

Select room EQ use for DIRECT or PURE DIRECT mode.

#### [Selectable items]

**ON** : Use room EQ.

**OFF** : Do not use room EQ.

### Mic Select

Select the microphone type if not using supplied mic. The microphone connected to V.AUX Lch is used.

#### [Selectable items]

**Mic** : Supplied mic is being used.

**V.AUX L** : Other mic connected to V.AUX is used.



Only a professionally certified installer should ever connect a professionally-calibrated microphone to the V.AUX L input on the front panel.

## 3 Parameter Check

Check auto setup measurement results. This is displayed after the auto setup procedure is completed.

#### [Items to be checked]

**Speaker Config. Check**

**Distance Check**

**Channel Level Check**

**Crossover Freq. Check**

**EQ Check**



The auto setup results can be reset to what was originally calculated by MultEQ XT when "Restore" is selected.

# Manual Setup

Make detail settings for various parameters.

## Speaker Setup

Use this procedure to set the speakers manually or if you wish to change the settings made with the auto setup procedure.

### ● Menu screen ●

MENU

- 1. Auto Setup
- 2. Manual Setup
- 3. Input Setup
- 4. Parameter
- 5. Information

2. Manual Setup

- 1. Speaker Setup
- 2. HDMI Setup
- 3. Audio Setup
- 4. Zone Setup
- 5. Option Setup

## 1 Speaker Configuration

Select speaker configuration and size.  
(bass reproduction capability)

### Front Speaker

Select front speaker size.

[Selectable items] **Large** **Small**

### Center Speaker

Select center speaker use and size.

[Selectable items] **Large** **Small** **None**

### Subwoofer

Select subwoofer use.

[Selectable items] **Yes** **No**

## Surround Speaker

Select surround speakers use and size.

[Selectable items] **Large** **Small** **None**

## Surround Back Speaker

Select surround back speaker use and size.

[Selectable items] (**Large** **Small** **None**)  
(**2spkrs** **1spkr**)

### NOTE

By default, the AVR-988's "Amp Assign" setting is set to "ZONE2". To use as the surround back speaker for the main zone, change the "Amp Assign" setting (☞ page 30).

**Large** : Select this when using large speakers with ample low frequency reproduction capabilities.

**Small** : Select this when using small speakers without ample low frequency reproduction capabilities.

**None** : Select this when no speaker is connected.

**Yes** : Select this when a subwoofer is connected.

**No** : Select this when no subwoofer is connected.

**2spkrs** **1spkr** :

Select the number of surround back speakers.



- Select "Large" or "Small" not according to the physical size of the speaker but according to the low frequency reproduction capabilities based on the frequency set at "Crossover Frequency" (☞ page 27).
- When "Front Speaker" is set to "Small", "Subwoofer" is automatically set to "Yes".
- If "Subwoofer" is set to "No", "Front Speaker" is automatically set to "Large".
- If "Surround Speaker" is set to "None", "Surround Back Speaker" are automatically set to "None".
- When using just one surround back speaker, connect it to the left channel (SBL).

## 2 Subwoofer Setup

Select low range signal to be reproduced by subwoofer.

[Selectable items]

**LFE** : Play low range and LFE signal of channels set to "Small".

**LFE+Main** : Play low range and LFE signal of all channels.



- This can be set when menu "Speaker Configuration" – "Subwoofer" is set to "Yes".
- Play music or a movie source and select the mode offering the strongest bass.
- Select "LFE+Main" if you want the bass signals to always be produced from the subwoofer.

## 3 Distance

Set distance from listening position to speakers.  
Before making the settings, measure the distance from the listening position to the different speakers.

### Feet / Meters

Select unit for distance.

### Step

Select step. (smallest distance)

[Selectable items]

**1ft** **0.1ft** : Can be selected when "Feet" is set.

**0.1m** **0.01m** : Can be selected when "Meters" is set.

### Default

Resets the settings to the default values.

## Distance measurement

Select the speaker you want to set, then set the distance. Set the value closest to the measured distance.

### [Variable range]

**0.0ft ~ 60.0ft** : Display when "Feet" is set.

**0.00m ~ 18.00m** : Display when "Meters" is set.

### NOTE

Set the distance between the listening position and the various speakers to no more than 20.0 ft (6.00 meters).

## 4 Channel Level

Adjust channel levels to obtain equal volume from all speakers.

## Test Tone

Select test tone playback method.

### [Selectable items]

**Auto** : Automatically switch speaker from which test tone is output.

**Manual** : Manually switch speaker from which test tone is output.

## Test Tone Start

Output test tone.

[Variable range] **-12dB** ~ **0dB** ~ **+12dB**

## Default

Resets the settings to the default values.

## Operating from the remote control unit

Adjusting with the remote control unit using the test tones is only possible in the "Auto" mode and only effective in the STANDARD mode. The adjusted levels for the different modes are automatically stored in the memory.

### [Adjusting using test tones]

- 1 Press the **TEST** button.  
Test tones are output from the various speakers.
- 2 Use the **< >** button to adjust so that the volume is equal for all speakers.
- 3 When the adjustments are completed, press the **TEST** button again.



- When the menu "Speaker Configuration" – "Surround Back Speaker" setting (page 26) is set to "1spkr"; the surround back speaker display is set to "Surround Back Sp."
- Speakers set to "None" in the "Speaker Configuration" settings are not displayed.
- When "Channel Level" is adjusted, the adjusted values are set for all the surround modes. To adjust the channel level separately for the different surround modes, use the operation see page 48.

## 5 Crossover Frequency

Select crossover frequency from which subwoofer handles low range signal.

### [Selectable items]

**40Hz** **60Hz** **80Hz** **90Hz** **100Hz** **110Hz** **120Hz** **150Hz**  
**200Hz** **250Hz** :

Only the portion of the bass sound of the various speakers output from the subwoofer that has a frequency below the frequency set here is output.

Set this according to the low frequency reproduction capabilities of the speakers you are using.

### Advanced :

Set the crossover frequency separately for the different speakers.



- The "Crossover Frequency" can be set when there are speakers that have been set to "Small" at menu "Speaker Configuration" or when "Subwoofer" is set to "Yes" (page 26).
- If in the "Advanced" settings, "Subwoofer Setup" in the menu is set to "LFE"; it is possible to make this setting for speakers set to "Small" at "Speaker Configuration". If set to "LFE+Main", this setting can be made regardless of the speaker size.
- For speakers set to "Small", sound below the crossover frequency is cut from the sound output. The cut bass sound is output from the subwoofer or front speakers.
- Always set the crossover frequency to "80 Hz". When using small speakers, however, we recommend setting the crossover frequency to a higher frequency.

## HDMI Setup

Make settings for HDMI video/audio output.

### ● Menu screen ●

2. Manual Setup

1. Speaker Setup  
2. HDMI Setup  
3. Audio Setup  
4. Zone Setup  
5. Option Setup

2-2. HDMI Setup

1. HDMI Audio Setup  
2. HDMI Video Setup

## 1 HDMI Audio Setup

Make settings for HDMI audio output.

## HDMI Audio Out

Select HDMI audio output device.

### [Selectable items]

**AMP** : Use speakers connected to receiver for audio playback.

**TV** : Use speakers of monitor for audio playback.

## Auto Lipsync

Automatic compensation for timing shift in audio and video output.

### [Selectable items]

**ON** : Use automatic compensation.

**OFF** : Do not use automatic compensation.

## 2 HDMI Video Setup

Make settings for HDMI video output.

### i/p Scaler

Make settings for i/p scaler function.

#### [Selectable items]

**A to H** : Use i/p scaler function for analog video signal.

**OFF** : Do not use i/p scaler function.

### Resolution

Make settings for resolution of HDMI video output signal.

#### [Selectable items]

**Auto** : Detect monitor panel resolution and automatically set output resolution.

**480p/576p** : Output at 480p/576p resolution.

**1080i** : Output at 1080i resolution.

**720p** : Output at 720p resolution.

**1080p** : Output at 1080p resolution.



This can be set when "i/p Scaler" is set to "A to H".

#### NOTE

- It is not possible to convert "1080i" signals into "720p" format.
- It is not possible to convert "720p" signals into "1080i" format.

### Progressive Mode

Select optimum progressive mode for video material.

#### [Selectable items]

**Auto** : Automatically detect video material type.

**Video1** : Select mode suitable for video playback.

**Video2** : Select mode suitable for video and 30-frame film material playback.



This can be set when "i/p Scaler" is set to "A to H".

### Aspect

This sets the aspect ratio when outputting 480i/576i or 480p/576p input signals from the HDMI output connector.

#### [Selectable items]

**FULL** : Output at 16:9 aspect ratio.

**NORMAL** : Output at 4:3 aspect ratio.



This can be set when "i/p Scaler" is set to "A to H".

### Color Space

Make settings for output color space.

#### [Selectable items]

**YCbCr** : Output using YCbCr format.

**RGB** : Output using RGB format.



When connected to a monitor with a DVI-D connector (HDCP compatible) using an HDMI/DVI converter cable, the signals are output in RGB format, regardless of this setting.

### RGB Range

Make settings for RGB output range.

#### [Selectable items]

**Normal** : Use video range from 16 (black) to 235 (white).

**Enhanced** : Video range from 0 (black) to 255 (white). Use this setting to avoid black washout.



When "YCbCr" is selected under "Color Space", "RGB Range" will have no effect.

## Audio Setup

Make settings for audio playback.

### Menu screen

2. Manual Setup

1. Speaker Setup
2. HDMI Setup
3. Audio Setup
4. Zone Setup
5. Option Setup

2-3. Audio Setup

1. EXT. IN SW Level
2. 2ch Direct/Stereo
3. Dolby Digital Setup
4. Auto Surround Mode
5. Manual EQ

## 1 EXT. IN Subwoofer Level

Set the subwoofer level for playback.

#### [Selectable items]

**0dB** **+5dB** **+10dB** :

Select according to the player in use.

**+15dB** :

This is the recommended level.

## 2 2ch Direct/Stereo

Make speaker settings for 2-channel mode playback.

### Setting

To change the settings, select "Custom".

#### [Selectable items]

**Basic** : Use the same settings as in "Speaker Setup".

**Custom** : Make separate settings for 2-channel mode.

## Front

Select front speaker size.

### [Selectable items]

**Large** **Small** : Select front speaker size.

## Subwoofer

Select subwoofer use.

### [Selectable items]

**Yes** **No** : Select subwoofer use.

## Subwoofer Mode

Select low range signal to be reproduced by subwoofer.

### [Selectable items]

**LFE** **LFE+Main** : Select subwoofer signal.

## Crossover

Select crossover frequency from which subwoofer handles low range signal.

### [Selectable items]

**40Hz** **60Hz** **80Hz** **90Hz** **100Hz** **110Hz** **120Hz** **150Hz**  
**200Hz** **250Hz** : Select crossover frequency.

## Distance FL

Set distance from listening position to front left speaker.

[Variable range] **0.0ft ~ 60.0ft**

## Distance FR

Set distance from listening position to front right speaker.

[Variable range] **0.0ft ~ 60.0ft**

## 3 Dolby Digital Setup

Set dynamic range for downmix playback of Dolby Digital sources.

### [Selectable items]

**ON** : Compression is used. Select this if sound from front speakers is distorted.

**OFF** : Do not use compression. This is the recommended setting.



- Set this to "ON" if the sound from the front speakers seems distorted.
- When not using the center speaker or surround speakers, the playback sound is down-mixed and output from the front speakers.

## 4 Auto Surround Mode

Make setting for memorizing surround mode setting for each input signal type.

### [Selectable items]

**ON** : Memorize settings. Most recently stored surround mode is automatically selected.

**OFF** : Do not memorize settings. Surround mode does not change according to input signal.



- The auto surround mode function lets you store in the memory the surround mode last used for playing the four types of input signals listed below.
  - ① Analog and PCM 2-channel signals
  - ② Dolby Digital and DTS 2-channel signals
  - ③ Dolby Digital and DTS multi-channel signals
  - ④ Multi-channel signals other than Dolby Digital and DTS (PCM, DSD, etc.)
- When playing in the PURE DIRECT mode, the surround mode does not change even if the input signal is changed.

## 5 Manual EQ

Adjust tonal quality for each speaker using graphic equalizer.

### Base Curve Copy

Copy the Room EQ's "Audyssey Flat" correction curve.

[Selectable items] **Yes** **No**



"Base Curve Copy" is displayed after the auto setup procedure has been performed.

### Adjust CH

Select speaker adjustment method.

### [Selectable items]

**Each CH** : Adjust tonal quality for each speaker separately.

**L/R CH** : Adjust tonal quality for each L/R speaker pair.

**ALL CH** : Adjust tonal quality for all speakers together.

### Manual EQ

Select the speaker and frequency band and adjust the level.

[Selectable items] **63Hz** **125Hz** **250Hz** **500Hz** **1kHz**  
**2kHz** **4kHz** **8kHz** **16kHz**

[Variable range] **-20dB** ~ **0dB** ~ **+6dB**

### Default

Resets the settings to the default values.



## ZONE2 Setup

Make settings for audio playback in a ZONE2 system.

### ● Menu screen ●

#### 2. Manual Setup

1. Speaker Setup
2. HDMI Setup
3. Audio Setup
4. Zone2 Setup
5. Option Setup

#### 2-4. Zone2 Setup

Level Lch : ◀ 0dB ▶  
Rch : ◀ 0dB ▶  
Vol. Level : ◀ VAR ▶  
Vol. Limit : ◀ OFF ▶  
Power On Lev. : Last ▶  
Mute Lev. : ◀ Full ▶

### 1 Lch Level

Adjust the left channel output level.

[Variable range] **-12dB** ~ **0dB** ~ **+12dB**

### 2 Rch Level

Adjust the right channel output level.

[Variable range] **-12dB** ~ **0dB** ~ **+12dB**

### 3 Volume Level

Adjust the main volume level.

#### [Selectable items]

- VAR** : Allow volume adjustment by remote control.  
**-40dB** : Fix the volume to -40 dB.  
**0dB** : Fix the volume to 0 dB.



"VAR" is displayed when a power amplifier is assigned to the ZONE2 output channel at menu "Manual Setup" – "Option Setup" – "Amp Assign" (page 30).

### 4 Volume Limit

Make a setting for maximum volume.

#### [Selectable items]

- OFF** : Do not set a maximum volume.  
**-20dB** : Set the maximum volume to -20 dB.  
**-10dB** : Set the maximum volume to -10 dB.  
**0dB** : Set the maximum volume to 0 dB.

### 5 Power On Level

Define the volume setting that is active when the power is turned on.

#### [Selectable items]

- Last** : Use the memorized setting from the last session.  
**---** : Always use the muting on condition when power is turned on.  
**-70dB ~ +18dB** : Set the volume level when the power is turned on in units of 1 dB.

### 6 Mute Level

Set the amount of attenuation when muting is on.

#### [Selectable items]

- Full** : The sound is cut off entirely.  
**-40dB** : The sound is attenuated by 40 dB.  
**-20dB** : The sound is attenuated by 20 dB.

## Option Setup

Make various other settings.

### ● Menu screen ●

#### 2. Manual Setup

1. Speaker Setup
2. HDMI Setup
3. Audio Setup
4. Zone Setup
5. Option Setup

#### 2-5. Option Setup

1. Amp Assign
2. Vol. Control
3. Source Delete
4. On Screen Display
5. Quick Select Name
6. Trigger Out
7. Remote ID Setup
8. 2Way Remote
9. Display
10. Setup Lock

### 1 Amp Assign

Define how the amplifier for the surround back speaker channels is used.

The places where the surround back amplifier are used can be set freely according to the usage environment. This makes it possible to output sound to rooms other than the room (the main zone) where surround playback is performed (multi-zone playback) or play the sound with high quality using the front speakers (bi-amp connections).

#### [Selectable items]

**7.1ch** **ZONE2** **FrontA Bi-Amp** **FrontB Bi-Amp** **2ch**



For details, see "Amp Assign / Multi-zone Connections and Operations" (page 55 ~ 57).

## 2 Volume Control

Set the main zone volume setting.

### Volume Limit

Make a setting for maximum volume.

#### [Selectable items]

**OFF** : Do not set a maximum volume.

**-20dB** : Set the maximum volume to -20 dB.

**-10dB** : Set the maximum volume to -10 dB.

**0dB** : Set the maximum volume to 0 dB.

### Power On Level

This sets the volume set when the main zone's power is turned on.

#### [Selectable items]

**Last** : Use the memorized setting from the last session.

**---** : Always use the muting on condition when power is turned on.

**-80dB ~ +18dB** : Set the volume level when the power is turned on in units of 1 dB.

### Mute Level

This sets the amount of attenuation of the volume when the mute mode is set in the main zone.

#### [Selectable items]

**Full** : The sound is cut off entirely.

**-40dB** : The sound is attenuated by 40 dB.

**-20dB** : The sound is attenuated by 20 dB.

## 3 Source Delete

Remove input sources that are not used from the display.

#### [Selectable items]

**ON** : Use this source.

**Delete** : Do not use this source.

#### NOTE

- Input sources being used in the various zones cannot be deleted.
- Input sources set to "Delete" cannot be selected using the **SOURCE SELECT** knob on the main unit or **SOURCE SELECT** button on the remote control unit.

## 4 On-Screen Display

Make on-screen display related settings.

### Screensaver

Make screensaver settings.

Use the screensaver to prevent burn-in on the monitor screen.

#### [Selectable items]

**ON** : Activate the screensaver if there is no activity for about 3 minutes.

**OFF** : Turn the screensaver function off.

### Text

Input source and mode display.

#### [Selectable items]

**ON** : Turn display on.

**OFF** : Turn display off.

### Master Volume

Master volume display during adjustment.

#### [Selectable items]

**ON** : Turn display on.

**OFF** : Turn display off.

## Tuner Information

This sets the time the on-screen display is displayed when an operation is performed.

#### [Selectable items]

**Always** : Show display continuously.

**30sec** : Show display for 30 seconds after operation.

**10sec** : Show display for 10 seconds after operation.

**OFF** : Turn display off.

## iPod Information

This sets the time the on-screen display is displayed when an operation is performed.

#### [Selectable items]

**Always** : Show display continuously.

**30sec** : Show display for 30 seconds after operation.

**10sec** : Show display for 10 seconds after operation.

**OFF** : Turn display off.

## Display Mode

Select the on-screen display's display mode.

#### [Selectable items]

**Mode1** : If there is no video signal, flickering of the on-screen display is not prevented.

**Mode2** : Prevents flickering of the on-screen display when there is no video signal. Use this mode if the on-screen display does not appear in the Mode 1, as may happen according to the TV being used.

## 5 Quick Select Name

Change the Quick Select name.

Up to 16 characters can be input.

#### [Input characters]

**A ~ Z a ~ z 0 ~ 9 ! # % & ' ( ) \* + , - . / : ; = " ? @ [ \ ] (space)**

## 6 Trigger Out

Select the conditions to turn on the trigger out with respect to the zone, input source, surround mode. For details about the trigger out function, see page 19.

Select "Trigger Out 1" or "Trigger Out 2" and make the settings below respectively.

### [Selectable items]

**ON** : Activate trigger on this mode.

**---** : Do not activate trigger on this mode.

### Setting with Respect to the Zone

- When the power of the zone turned on/off, the trigger out turns on.
- Associated with the power supply of zones set to "ON".

### Setting with Respect to the Input Source

- When the input source set to on is selected, the trigger out turns on.
- Associated with respect to the input source for zones set to "ON" at "Setting with Respect to the Zone".

### Setting with Respect to the Surround Mode

- When the surround mode set to on is selected, the trigger out turns on.
- Associated with respect to surround modes that are set to "ON".
- This can be set if the "MAIN ZONE" setting at "Setting with Respect to the Zone" is set to "ON".
- Associated when an input source for which "Setting with Respect to the Input Source" is set to "ON" is selected.

## 7 Remote ID Setup

Set remote control ID.

[Selectable items] **1** **2** **3** **4**

### NOTE

When using the AVR-988 with only the included remote control unit (RC-1069), there is no need to make settings.

When using a separately sold remote control unit (RC-7000CI, etc.), this function can be used. Match the ID setting of the remote control unit and the receiver.

## 8 2Way Remote

Make setting for 2-way remote control unit.

[Selectable items]

**Used** : Use 2-way remote control.

**Not Used** : Do not use 2-way remote control.



When using a 2-way remote control unit (RC-7000CI and RC-7001RCI, sold separately), set this to "Used".

## 9 Display

Adjust display brightness of the receiver.

[Selectable items]

**Bright** : Normal display brightness.

**Dim** : Reduced display brightness.

**Dark** : Very low display brightness.

**OFF** : Display is off unless controls are operated.



### Operating from the main unit

Press the **DIMMER** button.



## 10 Setup Lock

Protect settings from inadvertent change.

[Selectable items]

**ON** : Turn protection on.

**OFF** : Turn protection off.



- When "Setup Lock" is set to "ON", the settings listed below can no longer be changed. Also, "SETUP LOCKED!" is displayed if you attempt to operate related buttons.
  - Menu operations
  - RESTORER
  - Night Mode
  - Parameter
  - Room EQ
  - Channel Level
  - Audio Delay
- To cancel the setting, press the **MENU** button to re-display the "Setup Lock" screen, then change the setting to "OFF".

# Input Setup

Use this procedure to select the input source and make the settings related to playing input sources.

## TUNER (AM/FM)

This menu is for "TUNER".

### Menu screen

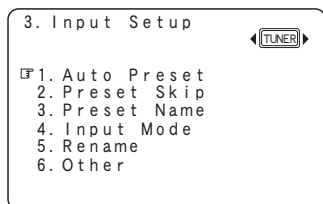

## XM

This menu is for "XM".

### Menu screen

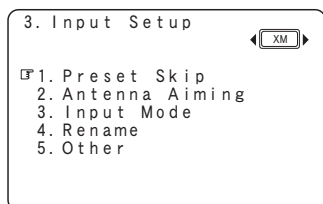

## PHONO

This menu is for "PHONO".

### Menu screen

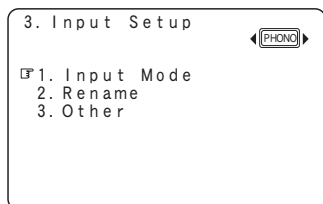

## CD, DVD, HDP, TV/CBL, SAT, VCR, DVR, V.AUX

This menu is for "CD"; "DVD"; "HDP"; "TV/CBL"; "SAT"; "VCR"; "DVR"; "V.AUX".

### Menu screen

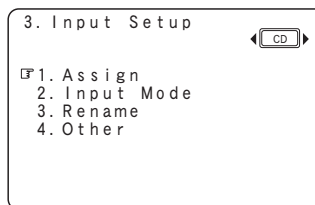

※ The menu settings below can be made for these input sources when "iPod dock" is set to "Assign".

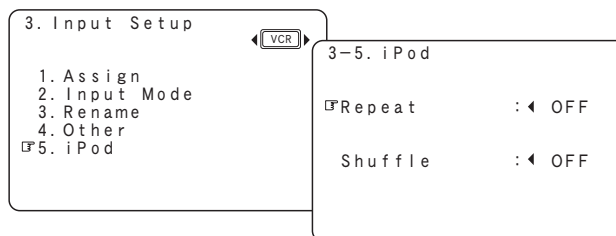

## Changing the input source within Input Setup

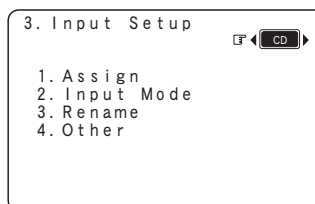

The input source currently selected in the main zone is not changed even when the input source within Input Setup is changed.

# Settings Related to Playing Input Sources

## Auto Preset

Use the auto preset function to program radio stations.

[Input source] **TUNER**

[Selectable items]

**Start** : Start the auto preset process.



If an FM station cannot be preset automatically, select the desired station by tuning it in manually, then preset it manually.

## Preset Skip

Set the preset memories that you do not want to display when tuning.

## A ~ G

Select the preset channel(s) you do not want to display.

[Input source] **TUNER** **XM**

[Selectable items]

**ON** : Display this number.

**Skip** : Skip this number.

## Preset Name

Assign name to a preset memory.  
Names containing up to 8 characters can be input.

## A1 ~ G8

Select the preset memory number.

[Input source] **TUNER**

[Characters that can be input]

**A ~ Z** **a ~ z** **0 ~ 9** **! # % & ' ( ) \* + , - . / : ; = " ? @ [ \ ] (space)**

## Input Mode

Make input mode and decode mode settings for this source.  
The selectable input modes depend on the input source and "Assign" setting (page 34, 35).

### Input Mode

Set the input mode for this source.

[Input source] **TUNER** **PHONO**

#### [Selectable items]

**Analog** : Play only signals from analog input.

**EXT. IN** : Play only signals from EXT. IN input.

[Input source] **XM**

#### [Selectable items]

**AUTO** : Automatically detect input signal and perform playback.

**EXT. IN** : Play only signals from EXT. IN input.

[Input source] **CD** **DVD** **HDP** **TV/CBL** **SAT** **VCR** **DVR**  
**V.AUX**

#### [Selectable items]

**AUTO** : Automatically detect input signal and perform playback.

**HDMI** : Play only signals from HDMI input.

**Digital** : Play only signals from digital input.

**Analog** : Play only signals from analog input.

**EXT. IN** : Play only signals from EXT. IN input.



- When a digital signal is properly input, the "DIG." indicator lights on the display. If the "DIG." indicator does not light, check the digital input connector assignment and the connections.
- The surround mode cannot be set if the input mode is set to "EXT. IN."



## Operating from the main unit or remote control unit

Press the **INPUT MODE** button on the main unit or the **INPUT** button on the remote control unit.



\*1: This can be selected for input sources for which the menu "Assign" setting is set to "HDMI." Excluding CD.

\*2: This can be selected for input sources for which the menu "Assign" setting is set to "Digital."

### Decode Mode

Set the decode mode for this source.

[Input source] **CD** **DVD** **HDP** **TV/CBL** **SAT** **VCR** **DVR**  
**V.AUX**

#### [Selectable items]

**AUTO** : Detect type of digital input signal and decode and play automatically.

**PCM** : Decode and play only PCM input signals.

**DTS** : Decode and play only DTS input signals.



- This can be selected for input sources for which the menu "Assign" setting is set to "HDMI" or "Digital" (page 34, 35).
- Only set "PCM" and "DTS" when playing the respective signals.

## Rename

Change the display name for this source.  
Names containing up to 8 characters can be input.

#### [Characters that can be input]

**A ~ Z** **a ~ z** **0 ~ 9** **! # % & ' ( ) \* + , - . / : ; = " ? @ [ \ ]** (space)

## Assign

Assign input sources to input connectors.

### HDMI

Select HDMI connector to assign to this source.

[Input source] **DVD** **HDP** **TV/CBL** **SAT** **VCR** **DVR**  
**V.AUX**

#### [Selectable items]

**1** : Assign HDMI1 input connector.

**2** : Assign HDMI2 input connector.

**None** : No HDMI input connector assigned.

Input source	DVD	HDP	TV/CBL	SAT	VCR	DVR	V.AUX
Default setting	<b>HDMI1</b>	<b>HDMI2</b>	None	None	None	None	None



- With HDMI, the video and audio signals are transferred simultaneously. If you want to play the video signal assigned at "HDMI" together with the audio signal assigned at "Digital In", set "Input Mode" on the menu to "DIGITAL".
- When the AVR-988 and monitor are connected with an HDMI cable, if the monitor is not compatible with HDMI audio signal playback, only the video signals are output to the monitor.
- The audio signals input from the analog, digital and EXT. IN connectors are not output to the monitor.

## Digital In

Select digital input connector to assign to this source.

[Input source] **CD** **DVD** **HDP** **TV/CBL** **SAT** **VCR** **DVR**  
**V.AUX**

### [Selectable items]

- COAX1** : Assign COAXIAL 1 input connector.
- COAX2** : Assign COAXIAL 2 input connector.
- COAX3** : Assign COAXIAL 3 input connector.
- OPT1** : Assign OPTICAL 1 input connector.
- OPT2** : Assign OPTICAL 2 input connector.
- OPT3** : Assign OPTICAL 3 input connector.
- OPT4** : Assign OPTICAL 4 input connector.
- None** : No digital input connector assigned.

Input source	CD	DVD	HDP	TV/CBL	SAT	VCR	DVR	V.AUX
Default setting	COAX3	COAX1	None	COAX2	OPT1	OPT3	OPT2	OPT4

## Component In

Select component video input to assign to this source.

[Input source] **DVD** **HDP** **TV/CBL** **SAT** **VCR** **DVR**  
**V.AUX**

### [Selectable items]

- 1-RCA** : Assign component video 1 input connector.
- 2-RCA** : Assign component video 2 input connector.
- 3-RCA** : Assign component video 3 input connector.
- None** : No component video input connector assigned.

Input source	DVD	HDP	TV/CBL	SAT	VCR	DVR	V.AUX
Default setting	1-RCA	2-RCA	3-RCA	None	None	None	None

## iPod dock

Assign Control Dock for iPod to this source.

[Input source] **CD** **DVD** **HDP** **TV/CBL** **SAT** **VCR** **DVR**  
**V.AUX**

### [Selectable items]

- Assign** : Assign iPod input.
- None** : Do not assign iPod input.



- With the default settings, the Control Dock for iPod can be used connected to the VCR (iPod) connector.
- Even if "iPod dock" is set to "Assign," if the AVR-988 is not connected to a Control Dock for iPod, the input source can be used as the normal input source.

## iPod

Make settings for "iPod" playback.

[Input source] **CD** **DVD** **HDP** **TV/CBL** **SAT** **VCR** **DVR**  
**V.AUX**

## Repeat

Make settings for repeat mode.

### [Selectable items]

- All** : Repeat all songs.
- One** : Repeat the current song.
- OFF** : Cancel repeat mode.

## Shuffle

Make settings for shuffle mode.

### [Selectable items]

- Songs** : Shuffle all songs.
- Albums** : Shuffle songs from current album only.
- OFF** : Cancel shuffle mode.



This can be selected for input sources for which "Assign" is assigned at the "iPod dock" setting.

## Other

Make various other settings.

## Video Select

Switch video input source while listening to audio signal.

### [Selectable items]

**DVD** **HDP** **TV/CBL** **SAT** **VCR** **DVR** **V.AUX** :

Select video input source to view.

**Source** :

The video and audio for the same input source are played.



### Operating from the main unit

Press the **VIDEO SELECT** button, then turn the **SOURCE SELECT** knob until the desired picture appears.

※ To cancel, press the main unit's **VIDEO SELECT** button, then turn the main unit's **SOURCE SELECT** knob and select "Source".

### NOTE

- It is not possible to select HDMI input signals.
- When playing HDMI video input signals, the analog video signal of another input source cannot be selected for the HDMI video output.
- Input sources for which "Delete" is selected at "Source Delete" cannot be selected.

## Video Convert

Automatically convert video input signal to monitor output format.

[Input source] **DVD** **HDP** **TV/CBL** **SAT** **VCR** **DVR**  
**V.AUX**

### [Selectable items]

**ON** : Enable conversion.  
**OFF** : Disable conversion.

### NOTE

When a non-standard video signal from a game machine or some other source is input, the video conversion function might not operate. If this happens, please set the conversion mode to "OFF".

## Source Level

Corrects the playback level of the selected input source's audio input.

[Variable range] **-12dB** ~ **0dB** ~ **+12dB**



For input sources for which "HDMI" and "Digital" are set at the menu "Assign" setting, the analog input level and digital input level can be set separately.

## Antenna Aiming

Adjust the XM radio reception sensitivity.

[Input source] **XM**

## Satellite

Indicate satellite signal strength.

## Terrestrial

Indicate terrestrial signal strength.

Display	Condition
■■■■■	Signal strength is strong
■■■■	Signal strength is good
■■■	Signal strength is marginal
■■	Signal strength is weak
■	No signal

# Surround Modes

## Standard Playback

This is the standard mode for enjoying surround sound according to the program source.

## Surround Playback of 2-channel Sources

To select these surround modes using the buttons on the main unit and remote control unit, press the **STANDARD** button on the main unit or **STD** button on the remote control unit. The mode switches each time the button is pressed.

When using a surround back speaker

[Selectable items] **DOLBY PLIIx** **DTS NEO:6** **neural**

When not using a surround back speaker

[Selectable items] **DOLBY PLII** **DTS NEO:6** **neural**

**DOLBY PLIIx** or **DOLBY PLII** : The signals are decoded in DOLBY PLIIx or DOLBY PLII for playback.

**Cinema** : This mode is suited for movie sources.

**Music** : This mode is suited for music sources.

**Game** : This mode is suited for games.

**Pro Logic** : This is the Pro Logic playback mode. This can be selected when playing with a DOLBY PLII decoder. When this mode is selected, "DOLBY PL" is displayed.

**DTS NEO:6** : The signals are decoded in DTS NEO:6 for playback.

**Cinema** : This mode is suited for movie sources.

**Music** : This mode is suited for music sources.

**neural** : It is possible to play analog input signals and PCM (2-channel, 48 kHz or less) in the surround mode.

This is the optimum mode for playing sources recorded in XM HD Surround (page 61).



Select the "Cinema", "Music", "Game" and "Pro Logic" modes at menu "Parameter" - "Surround Parameter" - "MODE" (page 38).

## Playing Multi-channel Sources (Dolby Digital, DTS, etc.)

### [Selectable items]

**STANDARD** :

This mode is for decoding the input signals according to their format and playing surround sound.

The display when the STANDARD mode is selected depends on the input signal and surround back output playback mode.

Input signal		Display
Dolby Digital Source	DOLBY DIGITAL (other than 2ch) / DOLBY DIGITAL EX	DOLBY DIGITAL DOLBY DIGITAL EX DOLBY DIGITAL+PLIIx CINEMA DOLBY DIGITAL+PLIIx MUSIC
	DOLBY DIGITAL Plus	DOLBY DIGITAL +
	DOLBY TrueHD	DOLBY TrueHD
DTS Surround Source	DTS (5.1 ch) / DTS-ES Discrete 6.1 / DTS-ES Matrix 6.1 / DTS 96/24	DTS SURROUND DTS+PLIIx CINEMA DTS+PLIIx MUSIC DTS+NEO:6 DTS ES MTRX6.1 (*1) DTS ES DSCRT6.1 (*2) DTS 96/24 (*3)
	DTS-HD High Resolution Audio	DTS-HD HI RES
	DTS-HD Master Audio	DTS-HD MSTR
	DVD-Audio, SACD	PCM (multi ch) / DSD (multi ch)

\*1 : This is displayed when the input signal is "DTS-ES Matrix 6.1" and the AVR-988's "AFDM" setting is set to "ON".

\*2 : This is displayed when the input signal is "DTS-ES Discrete 6.1".

\*3 : This is displayed when the input signal is "DTS 96/24".



For details, see page 64.

## DSP Simulation Playback

The desired mode according to the program source and viewing situation can be selected from among 10 DENON original surround modes.

The surround parameters can be adjusted (page 62, 63) to achieve an even more realistic, powerful sound field.

### [Selectable items]

**7CH STEREO** : This mode is for enjoying stereo sound from all speakers.

**WIDE SCREEN** : This mode is for enjoying the atmosphere of viewing a movie on a large screen.

**SUPER STADIUM** : This mode is suited for viewing sports programs.

**ROCK ARENA** : This mode is for enjoying the atmosphere of a live concert in an arena.

**JAZZ CLUB** : This mode is for enjoying the atmosphere of a live concert in a jazz club.

**CLASSIC CONCERT** : This mode is for appreciating classical concert programs.

**MONO MOVIE** \* : This mode is for playing monaural movie sources with surround sound.

**VIDEO GAME** : This mode is suited for achieving surround sound with video games.

**MATRIX** : This mode lets you add a sense of expansion to stereo music sources.

**VIRTUAL** : This mode is for enjoying surround effects using only the front speakers or headphones.

\* : When playing sources recorded in monaural in the MONO MOVIE mode, the sound will be off balance with a single channel (left or right), so input to both channels.



- To select these surround modes using the buttons on the remote control unit, press the **SIMU** button. The mode switches each time the button is pressed.
- Depending on the program source being played, it may not be possible to achieve a satisfactory surround effect. In this case, try other modes to achieve a sound field suited to your tastes.

## Stereo Playback

### [Selectable items]

**STEREO** :

This is the mode for playing in stereo. The tone can be adjusted. Sound is output from the front left and right speakers and subwoofer.

## Direct Playback

### [Selectable items]

**DIRECT** :

In this mode the signals bypass the tone adjustment circuitry for high quality sound.

The sound is output to the same channels as the input signal.

The display when the DIRECT mode is selected depends on the input signal.

For multi-channel sources, the display depends on the surround back output's play mode.

Input signal	Display
Analog signal / PCM (2ch) / Dolby Digital source / DTS source / Other 2-channel digital signals	DIRECT
DSD (2ch)	DSD DIRECT (*)
PCM (multi ch)	MULTI CH DIRECT
	M DIRECT + PLIIx CINEMA
	M DIRECT + PLIIx MUSIC
	M DIRECT 7.1
DSD (multi ch)	DSD MULTI DIRECT (*)

\* : When DSD signals are converted to PCM signals as set by the audio parameters and speaker settings, "DIRECT" or "MULTI CH DIRECT" is displayed.



For details, see page 65.

## Playback in the PURE DIRECT Mode

This is the mode that recreates the original sound most faithfully, providing extremely high quality sound.

Press the **PURE DIRECT** button.



- When in the PURE DIRECT mode, the menu screen is not displayed and the display on the main unit is turned off.
- If the HDMI input connector is selected, video outputs are output in the PURE DIRECT mode.
- The channel level and surround parameters in the PURE DIRECT mode are the same as in the DIRECT mode.



# Parameter

## ● Menu screen ●

- 4. Parameter
  - 1. Surround Parameter
  - 2. Tone Control
  - 3. Room EQ
  - 4. RESTORER
  - 5. Night Mode
  - 6. Audio Delay

## 1 Surround Parameter

Adjust surround sound parameters.

The adjustable parameters differ for the different surround modes (page 62, 63).

## MODE

Select the mode according to the playback source.

In the PLIIx or PLII mode

[Selectable items] **CINEMA** **MUSIC** **GAME** **PL** \*

\*: Can be selected in the PLII mode.

In the DTS NEO:6 mode

[Selectable items] **CINEMA** **MUSIC**

**CINEMA** : Surround sound mode optimized for movie sources.

**MUSIC** : Surround sound mode optimized for music sources.

**GAME** : Surround sound mode optimized for games.

**PL** : Dolby Pro Logic playback mode.



The MUSIC mode is also effective for movie sources including a lot of stereo music.

## CINEMA EQ

Soften the treble range of movie soundtracks for better understanding.

### [Selectable items]

**ON** : CINEMA EQ is used.

**OFF** : CINEMA EQ is not used.

## D.COMP

Compress dynamic range (difference between loud and soft sounds).

### [Selectable items]

**OFF** : Turn dynamic range compression off.

**LOW** : Low setting.

**MID** : Middle setting.

**HIGH** : High setting.



When playing DTS sources, this is only displayed for compatible software.

## DRC

Compress dynamic range (difference between loud and soft sounds).

### [Selectable items]

**AUTO** : Automatic dynamic range compression on/off control according to source.

**LOW** : Low setting.

**MID** : Middle setting.

**HIGH** : High setting.

**OFF** : Dynamic range compression always off.



This can be set in the Dolby TrueHD mode.

## LFE

Adjust the low-frequency effects level (LFE).

[Variable range] **-10dB** ~ **0dB**



For proper playback of the different program sources, we recommend setting to the values below.

- Dolby Digital sources: "0 dB"
- DTS movie sources: "0 dB"
- DTS music sources: "-10 dB"

## CENTER IMAGE

Assign center channel signal to front left and right channels for wider sound.

[Variable range] **0.0** ~ **0.3** ~ **1.0**

## PANORAMA

Assign front L/R signal also to surround channels, for wider sound. If the surround effect seems weak, set "PANORAMA" to "ON".

[Selectable items] **ON** **OFF**

## DIMENSION

Shift sound image center to front or rear, to adjust playback balance.

[Variable range] **0** ~ **3** ~ **6**

## CENTER WIDTH

Assign center channel signal to front left and right channels for wider sound.

[Variable range] **0** ~ **3** ~ **7**

## DELAY TIME

Adjust delay time to control sound stage size.

[Variable range] **0 ms** ~ **30 ms** ~ **300 ms**

## EFFECT

Switch effect signal for multi-surround speakers on and off. When "EFFECT" is set to "ON", a surround effect with a strong sense of expansion is achieved.

[Selectable items]  ON  OFF

## LEVEL

Adjust effect signal level.

[Variable range]  1 ~  10 ~  15



Set to a lower level if the positioning and sense of phase of the surround signals seems unnatural.

## ROOM SIZE

Determine size of acoustic environment.

[Selectable items]

- small** : Simulate acoustics of a small room.
- med. s**
- medium**
- med. l**
- large** : Simulate acoustics of a large room.



### NOTE

"ROOM SIZE" does not indicate the size of the room in which sources are played.

## AFDM (Auto Flag Detect Mode)

Auto-select surround mode by source.

This function only works for software containing a special identification signal.

If the software being played is recorded in Dolby Digital EX or DTS-ES, it is played in 6.1-channels. If not, it is played in 5.1-channels.

[Selectable items]  ON  OFF

### Example : Playing Dolby Digital software (with EX flag)

- When "AFDM" is set to "ON", the surround mode is automatically set to the DOLBY D + PLIIx C mode.
- To play in the DOLBY DIGITAL EX mode, set "AFDM" to "OFF" and "SB CH OUT" to "MTRX ON".



Some Dolby Digital EX sources do not include EX flags. If the playback mode does not switch automatically even when "AFDM" is set to "ON", set "SB CH OUT" to "MTRX ON" or "PLIIx CINEMA".

## SB CH OUT (for Multi-channel sources)

Select playback mode for surround back channels.

[Selectable items]

- OFF** : No signal is played from the surround back channels.
- NON MTRX** : The same signals as those of the surround channels are output from the surround back channels.
- MTRX ON** : The surround channel signals undergo digital matrix processing and are output from the surround back channels.
- PLIIx CINEMA** \*1 : Decoded in Dolby Pro Logic IIx Cinema mode, surround back signal played.
- PLIIx MUSIC** \*2 : Decoded in Dolby Pro Logic IIx Music mode, surround back signal played.
- ES MTRX** \*3 : DTS signal played with digital matrix processing.
- ES DSCRT** \*4 : Signal included in DTS-ES Discrete 6.1-channel sources played.
- DSCRT ON** : Mode for discrete playback of surround back signals included in 7.1-channel digital discrete audio signals (DVD, etc.).

\*1: This can be selected when "Surround Back" is set to "2spkr" at the menu "Manual Setup" – "Speaker Setup" – "Speaker Configuration" setting (page 26).

\*2: This can be selected when "Surround Back" is set to "2spkr" or "1spkr" at the menu "Manual Setup" – "Speaker Setup" – "Speaker Configuration" setting.

\*3: This can be selected when playing DTS sources.

\*4: This can be selected when playing DTS sources including a discrete 6.1-channel signal identification signal.

## SB CH OUT (for 2-channel sources)

Determine whether to use surround back speakers.

[Selectable items]

- ON** : The surround back channel signal is played.
- OFF** : The surround back channel signal is not played.



This operation can be performed directly pressing the **SURROUND BACK** button on the main unit.

## SW ATT

Attenuate subwoofer level when using EXT. IN mode.

[Selectable items]

- ON** : The input from the subwoofer channel is attenuated.
- OFF** : The input from the subwoofer channel is not attenuated. Usually use in this mode.



Set this to "ON" if the subwoofer channel level seems too high when playing Super Audio CD.

## Subwoofer

Turn subwoofer output on and off.

[Selectable items]

- ON** : The subwoofer is used.
- OFF** : The subwoofer is not used.

## Default

Resets the settings to the default values.

## 2 Tone Control

Adjust the tonal quality of the sound.

### Tone Defeat

Turn tone adjustments off.

#### [Selectable items]

**ON** : Playback without tone adjustment.

**OFF** : Allow tone adjustment (treble, bass).



The tone cannot be adjusted when in the DIRECT mode.

### Bass

Adjust low frequency range (bass).

[Variable range] **-6dB ~ +6dB**

### Treble

Adjust high frequency range (treble).

[Variable range] **-6dB ~ +6dB**



"Bass" and "Treble" can be set when "Tone Defeat" is set to "OFF".

## 3 Room EQ

Select room equalizer for current environment.

#### [Selectable items]

**Audyssey** : Optimize frequency response of all speakers.

**Audyssey Byp. L/R** : Optimize frequency response of speakers except front L and R speakers.

**Audyssey Flat** : Optimize frequency response of all speakers to flat response.

**Manual** : Apply frequency response set with "Manual EQ" (page 29).

**OFF** : Turn equalizer off.



### Operating from the main unit or main remote control unit

Press the **ROOM EQ** button on the main unit or the **EQ** button on the main remote control.

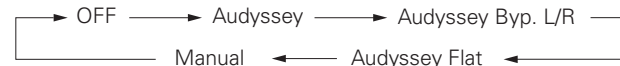

When "Audyssey" is selected, "AUDYSSEY MULTEQ XT" lights.

When "Audyssey Byp. L/R" or "Audyssey Flat" is selected, or when the auto setup measuring results have changed, "AUDYSSEY MULTEQ XT" lights.



- "Audyssey", "Audyssey Byp. L/R" and "Audyssey Flat" can be selected after the auto setup procedure has been performed.
- If the settings of the speakers for which "None" has been determined at "Auto Setup" are changed, "Audyssey", "Audyssey Byp. L/R" and "Audyssey Flat" cannot be selected and measurements have to be taken again to include the newly-added speakers.
- When using headphones, "Room EQ" is always set to "OFF".

## 4 RESTORER

This function restores compressed audio signals to how they were before compression and corrects the sense of volume of the bass and treble to obtain richer playback sound.

#### [Selectable items]

**OFF** :

Do not use RESTORER.

**Mode1** (RESTORER 64):

Optimized mode for compressed sources with very weak highs.

**Mode2** (RESTORER 96):

Apply suitable bass and treble boost for all compressed sources.

**Mode3** (RESTORER HQ):

Optimized mode for compressed sources with normal highs.

The default setting for "iPod" is "Mode3". All others are set to "OFF".



### Operating from the main unit or remote control unit

During playback, press the **RESTORER** button.

When set to something other than "OFF", "RESTORER" is displayed.

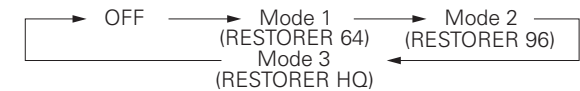

#### About the RESTORER function

- Such compressed audio formats as MP3, WMA (Windows Media Audio) and MPEG-4 AAC reduce the amount of data by eliminating signal components that are hard for the human ear to hear. The RESTORER function generates the signals eliminated upon compression, restoring the sound to conditions near those of the original sound before compression. It also corrects the sense of volume of the bass to obtain richer sound with compressed audio signals.
- This is displayed on the menu and can be set when the input source is selected to "XM", or analog signals (including AM/FM signals) or PCM signals (fs = 44.1/48 kHz) are input.

## 5 Night Mode

Optimized setting for late-night listening.

### [Selectable items]

**OFF** : Turn night mode off.

**LOW** : Low setting.

**MID** : Middle setting.

**HIGH** : High setting.



### Operating from the remote control unit

Press the **NIGHT** button.

The "**NIGHT**" indicator lights when "LOW," "MID" or "HIGH" is selected.



## 6 Audio Delay

Compensate for mismatched timing between video and audio.

Delay audio.

This sets the delay time for audio signals.

[Variable range] **0 ms** ~ **200 ms**

If you wish to adjust the "Audio Delay" while playing HDMI or component video signals, press  $\Delta$  to set on-screen display to "OFF". This way the audio delay can be adjusted while watching the picture. (Press  $\Delta$  again to switch to the on-screen display.)



### Operating from the main unit or remote control unit

※ When set using the procedure below, the on-screen display is not displayed. Adjust while watching the display.

① Press the **AUDIO DELAY** button.

② Use the  $\triangleleft$   $\triangleright$  button to set.



- This cannot be adjusted when playing in the EXT. IN, DIRECT or STEREO mode (with "Front Speaker" set to "Large," "Tone Defeat" to "ON" and "Room EQ" to "OFF")
- The adjustment range is 0 to 100 ms when the Auto Lipsync Correction function is activated.

# Information

## Status

Shows information about current settings.

### ● Menu screen ●

5. Information

- 1. Status
- 2. Audio Input Signal
- 3. HDMI Information
- 4. Auto Surround Mode
- 5. Quick Select
- 6. Preset Station

5-1. Status

Select Source: **PHONO**  
Name : Record  
Surround Mode:  
STEREO  
Input Mode : ANALOG

## 1 Main zone

Shows information about settings for main zone.

The items displayed differ according to the input source.

### [Items to be checked]

**Select Source** **Name** **Surround Mode** **Input Mode**

**Rec Select** **Video Select** **Source Level** **Room EQ**

**Night Mode** **RESTORER** etc.

## 2 ZONE2

Shows information about settings for multi-zone.

### [Items to be checked]

**Power** **Select Source** **Volume Level**

## Audio Input Signal

Shows information about audio input signals.

### ● Menu screen ●

5. Information

- 1. Status
- 2. Audio Input Signal
- 3. HDMI Information
- 4. Auto Surround Mode
- 5. Quick Select
- 6. Preset Station

5-2. Audio Input Signal

Surround Mode:  
DOLBY DIGITAL EX

SIGNAL: Dolby Digital  
fs : 48kHz  
Format: 3/2/.1  
Offset: -4dB

### [Items to be checked]

**Surround Mode** : The currently set surround mode is displayed.

**SIGNAL** : The input signal type is displayed.

**fs** : The input signal's sampling frequency is displayed.

**Format** : The number of channels in the input signal (front, surround, LFE) is displayed.

**Offset** : The dialogue normalization correction value is displayed.

**Flag** : "MATRIX" is displayed if the input signal has undergone matrix processing, "DISCRETE" if the input signal has undergone discrete processing.

### Dialogue normalization function

This is automatically activated when playing Dolby Digital sources. This function automatically corrects the standard signal level for individual program sources.

The correction value can be checked using the **STATUS** button on the main unit.

Dial.Norm  
Offset - 4dB

The figure is the correction value when the standard level is corrected.

## HDMI Information

Shows information about HDMI input/output signals and monitor.

### ● Menu screen ●

#### 5. Information

1. Status
2. Audio Input Signal
- ☑ 3. HDMI Information
4. Auto Surround Mode
5. Quick Select
6. Preset Station

#### 5-3. HDMI Signal Info.

Resolution  
480p

Color Space  
RGB 4:4:4

Pixel Depth  
8bits



#### 5-3. HDMI Monitor Info.



Interface  
HDMI

Support Resolution

480i/p

576i/p

1080i: 50Hz/60Hz

720p: 50Hz/60Hz

1080p: 50Hz/60Hz

1080p: 24Hz

### 1 HDMI Signal Information

The HDMI input/output signal information is displayed.

#### [Items to be checked]

Resolution Color Space Pixel Depth

### 2 HDMI Monitor Information

The HDMI monitor information is displayed.

#### [Items to be checked]

Interface Support Resolution

## Auto Surround Mode

Shows information about auto surround mode settings.  
The surround mode for which the last memory function was used for the different input signal types is displayed.

### ● Menu screen ●

#### 5. Information

1. Status
2. Audio Input Signal
3. HDMI Information
- ☑ 4. Auto Surround Mode
5. Quick Select
6. Preset Station

#### 5-4. Auto Surround Mode

[Analog] [PCM]  
2CH: STEREO

[Multi ch]  
: MULTI CH IN

[Digital]  
2CH: DOLBY PLIIx Cinema  
5. 1CH: DOLBY/DTS SURROUND

#### [Items to be checked]

Analog/PCM 2CH Multi ch Digital 2CH Digital 5.1CH

## Quick Select

Shows information about quick select settings.

### ● Menu screen ●

#### 5. Information

1. Status
2. Audio Input Signal
3. HDMI Information
4. Auto Surround Mode
- ☑ 5. Quick Select
6. Preset Station

#### 5-5. Quick Select

- ☑ 1. Quick Select 1
2. Quick Select 2
3. Quick Select 3

#### [Items to be checked]

Name Input Source Input Mode Volume Level

Analog/PCM 2CH Multi ch Digital 2CH Digital 5.1CH



For instructions on storing settings at Quick Select 1 to 3, see page 50.

## Preset Station

Shows information about preset stations.

### ● Menu screen ●

#### 5. Information

1. Status
2. Audio Input Signal
3. HDMI Information
4. Auto Surround Mode
5. Quick Select
- ☑ 6. Preset Station

#### 5-6. Preset Station

A1FM 87.50MHz

A2FM 89.10MHz

A3FM 98.10MHz

A4FM 107.90MHz

A5FM 90.10MHz

A6FM 90.10MHz

A7FM 90.10MHz

A8FM 90.10MHz



[Input source]

TUNER

XM

[Items to be checked]

A1 ~ G8



### Operating from the main unit

When the **STATUS** button on the main unit is pressed, the set's status can be checked on the display.

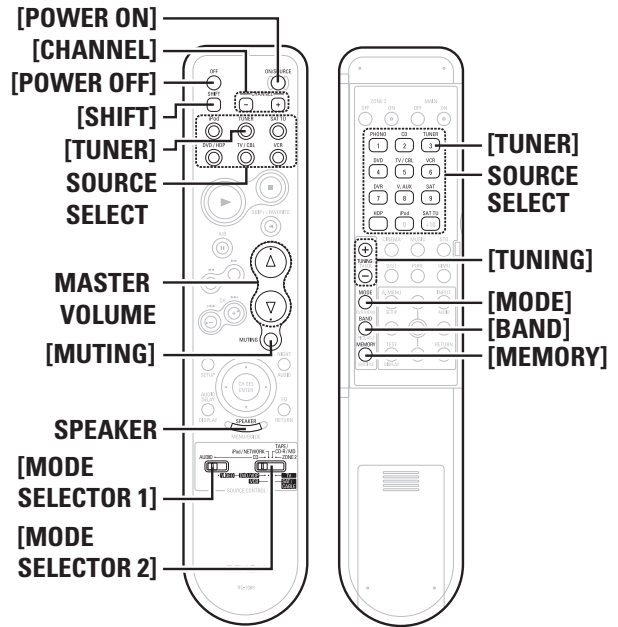
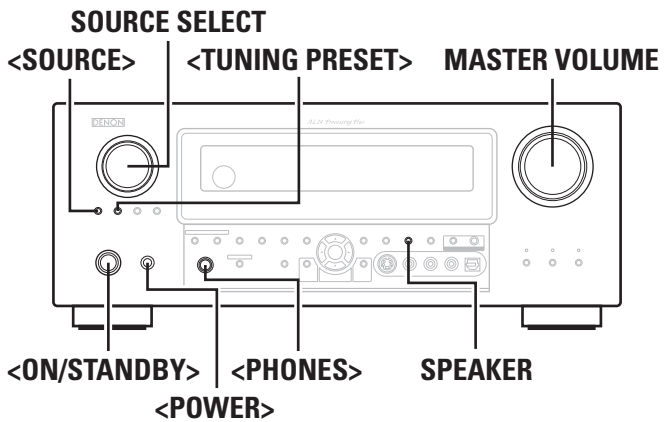

**About the button names in these explanations**  
 < > : Buttons on the main unit  
 [ ] : Buttons on the remote control unit  
**Button name only:**  
 Buttons on the main unit and remote control unit

# Playback

## Preparations

### Turning the Power On

- 1 Press **<POWER>**.  
The power indicator lights red and the power is set to the standby mode.
- 2 Press **<ON/STANDBY>** or **[POWER ON]**.  
The power indicator flashes green and the power turns on.

### Turning the Power Off

- ① Press **<ON/STANDBY>** or **[POWER OFF]**.  
The power is set to the standby mode.
- ② Press **<POWER>**.  
The power indicator turns off, and so does the power.

**NOTE**  
 Power continues to be supplied to some of the circuitry even when the power is in the standby mode. When leaving home for long periods of time or when traveling, either press **<POWER>** to turn off the power, or unplug the power cord from the power outlet.

## Selecting the input source

### Operation on the main unit

Turn **<SOURCE SELECT>**.

**NOTE**  
 If "Rec Select" or "Video Select" is selected for the input source, press **<SOURCE>** before turning **<SOURCE SELECT>**.

### Operation on the remote control unit

Set **[MODE SELECTOR 1]** to "AUDIO" then press **[SOURCE SELECT]**.  
 The desired input source can be selected directly.

## Operations During Playback

### Adjusting the Master Volume

Either turn **<MASTER VOLUME>** or press **[MASTER VOLUME]**.

### Turning Off the Sound Temporarily (Muting)

Press **[MUTING]**.

**NOTE**  
 To cancel, press **[MUTING]** again. Muting can also be canceled by adjusting the master volume.

### Listening with Headphones

Plug the headphones into **<PHONES>**.  
 The sound from the speakers and pre-out connectors is automatically cut.

**NOTE**  
 Be careful not to set the volume too high when using headphones.

### Switching the front speakers

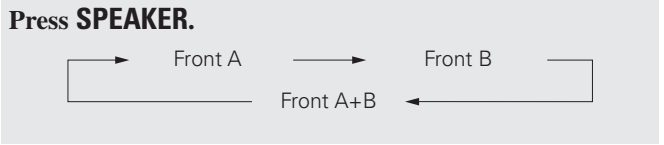

## Playing Video and Audio Equipment

### Basic Operation

#### 1 Prepare the equipment.

- ① Load the DVD, CD or other software in the player.  
(☞ See the operating instructions of the respective devices.)
- ② To play a video device, switch the monitor input.  
(☞ See the monitor's operating instructions.)

#### 2 Use **SOURCE SELECT** to select the input source.

#### 3 Set **[MODE SELECTOR 1]** to "AUDIO" or "VIDEO". (☞ page 51 "Remote Control Unit Operations")

#### 4 Set **[MODE SELECTOR 2]** to the component you want to operate.

#### 5 Start playback. (☞ See the operating instructions of the respective devices.)

## Listening to FM/AM Broadcasts

### Basic Operation

#### 1 Either turn <SOURCE SELECT> or press **[TUNER]** to select "TUNER".

#### 2 Set **[MODE SELECTOR 1]** to "AUDIO". (☞ page 51 "Remote Control Unit Operations")

#### 3 Press **[BAND]** to select "FM" or "AM".

#### 4 Tune in the desired broadcast station.

- ① **To tune in automatically (Auto Tuning)**  
Press **[MODE]** to light the "AUTO" indicator on the display, then use **[TUNING]** to select the station you want to hear.
- ② **To tune in manually (Manual Tuning)**  
Press **[MODE]** to turn off the display's "AUTO" indicator, then use **[TUNING]** to select the station you want to hear.



- It is also possible to switch to "FM" or "AM" in step 1 by pressing **[TUNER]**.
- If the desired station cannot be tuned in with auto tuning, tune it in manually.
- When tuning in stations manually, press and hold **[TUNING]** to change frequencies continuously.
- The time for which the menus are displayed can be set at menu "Manual Setup" – "Option Setup" – "On-Screen Display" (☞ page 31).

### Presetting Radio Stations (Preset Memory)

Your favorite broadcast stations can be preset so that you can tune them in easily. Up to 56 stations can be preset.

#### 1 Tune in the broadcast station you want to preset.

#### 2 Press **[MEMORY]**.

#### 3 Press **[SHIFT]** to select the block (A to G) in which the station is to be preset, then press **[CHANNEL]** to select the preset number (1 to 8).

#### 4 Press **[MEMORY]** again to complete the setting.



- To preset other stations, repeat steps 1 to 4.
- Stations can be preset automatically at menu "Input Setup" – "Auto Preset" (☞ page 33).

#### NOTE

Preset stations are erased by overwriting them.

## Listening to Preset Stations

### Operation on the Main Unit

Press <**TUNING PRESET**>, then turn <**SOURCE SELECT**> to select the preset radio station.

### Operation on the Remote Control Unit

#### 1 Press **[SHIFT]** to select the memory block (A to G).

#### 2 Press **[CHANNEL]** to select the desired preset channel (1 to 8).

#### □ Default settings

Auto tuner presets	
A1 ~ A8	87.5 / 89.1 / 98.1 / 107.9 / 90.1 / 90.1 / 90.1 / 90.1 MHz
B1 ~ B8	520 / 600 / 1000 / 1400 / 1500 / 1710 kHz, 90.1 / 90.1 MHz
C1 ~ C8	90.1 MHz
D1 ~ D8	90.1 MHz
E1 ~ E8	90.1 MHz
F1 ~ F8	90.1 MHz
G1 ~ G8	90.1 MHz

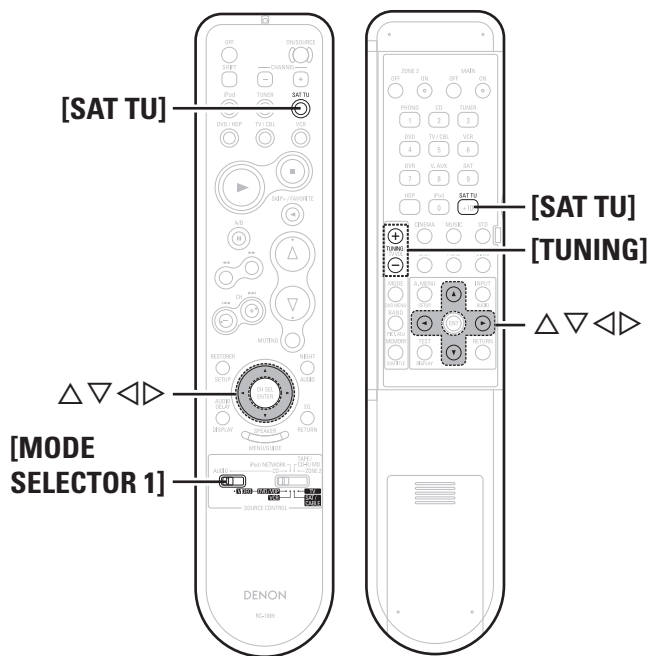
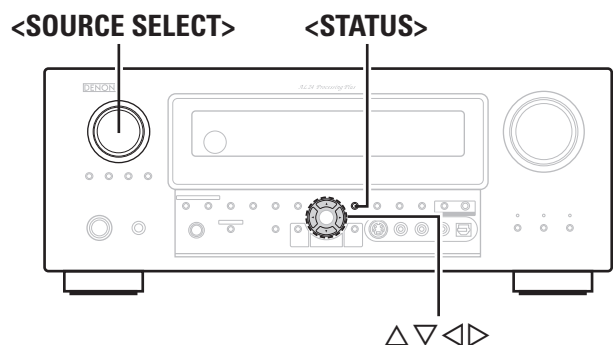

# Listening to XM Satellite Radio Programs

## ABOUT XM RADIO

XM Radio offers an extraordinary variety of commercial-free music, plus the best in premier sports, news, talk radio, stand-up comedy, children's and entertainment programming. XM is broadcast in superior digital audio from coast to coast. From rock to reggae, from classical to hip hop, XM has something for every music fan. For U.S. customers, information about XM Radio is available online at [www.xmradio.com](http://www.xmradio.com). For Canadian customers, information about XM Canada is online at [www.xmradio.ca](http://www.xmradio.ca).

## XM READY® LEGAL

XM monthly service subscription sold separately. XM Mini-Tuner and Home Dock required (each sold separately) to receive XM service. Installation costs and other fees and taxes, including a one-time activation fee may apply. All fees and programming subject to change. Channels with frequent explicit language are indicated with an XL. Channel blocking is available for XM radio receivers by calling 1-800-XMRADIO (US residents) and 1-877-GETXMSR (Canadian residents). For a full listing of the XM commercial-free channels and advertising-supported channels, visit [lineup.xmradio.com](http://lineup.xmradio.com) (US residents) or [xmradio.ca](http://xmradio.ca) (Canadian residents). Subscriptions subject to Customer Agreement available at [xmradio.com](http://xmradio.com) (US residents) and [xmradio.ca](http://xmradio.ca) (Canadian residents). Only available in the 48 contiguous United States and Canada. ©2007 XM Satellite Radio Inc. All rights reserved. All other trademarks are the property of their respective owners.

## XM READY® SUBSCRIPTIONS

Once you have installed the XM Mini-Tuner Dock, inserted the XM Mini-Tuner, connected the XM Dock to your XM Ready® home audio system, and installed the antenna, you are ready to subscribe and begin receiving XM programming. There are three places to find your eight character XM Radio ID: On the XM Mini-Tuner, on the XM Mini-Tuner package, and on XM Channel 0. Record the Radio ID in the following eight squares for reference.



**Note:** The XM Radio ID does not use the letters "I," "O," "S" or "F." Activate your XM Satellite Radio service in the U.S. online at <http://activate.xmradio.com> or call 1-800-XM-RADIO (1-800-967-2346). Activate your XM Satellite Radio service in Canada online at <https://activate.xmradio.ca> or call 1-877-GET-XMSR (1-877-438-9677). You will need a major credit card. XM will send a signal from the satellites to activate the full channel lineup. Activation normally takes 10 to 15 minutes, but during peak busy periods you may need to keep your XM Ready home audio system on for up to an hour. When you can access the full lineup on your XM Ready home audio system you are done.

## Basic Operation

- 1** Either turn <SOURCE SELECT> or press [SAT TU] to select "XM".
- 2** Set [MODE SELECTOR 1] to "AUDIO". (page 51 "Remote Control Unit Operations")
- 3** Use [TUNING] to select the station. When the station is tuned in, the name of the track and artist are displayed.

- The channel switches continuously when [TUNING] is pressed and held.
- XM Radio stations can be preset using the same procedure as for FM/AM stations (page 44 "Presetting Radio Stations (Preset Memory)" and "Listening to Preset Stations").
- The artist name, track name, category and reception level can be checked by pressing <STATUS>.
- The time for which the menus are displayed can be set at menu "Manual Setup" – "Option Setup" – "On-Screen Display" – "Tuner Information" (page 31).

**About the button names in these explanations**  
 < > : Buttons on the main unit  
 [ ] : Buttons on the remote control unit  
**Button name only:**  
 Buttons on the main unit and remote control unit



## Checking the XM Signal Strength and Radio ID

**1** Either turn <SOURCE SELECT> or press [SAT TU] to select “XM”.

**2** Press <STATUS> until “SIGNAL” appears on the display.

The display will switch as shown below, depending on the reception conditions.

Display	Status
GOOD	Signal strength is good
MARGINAL	Signal strength is marginal
WEAK	Signal strength is weak
NO	No signal

**3** Adjust the position of the antenna until “SIGNAL: GOOD” is shown on the display.

**4** Press <STATUS> until the station you want to check (example: “XM001”) is displayed.

**5** Press [TUNING] and select channel 0 (XM000).  
The radio ID is shown on the display.



XM000 RADIO ID  
\*\*\*\*\* ← Radio ID



The strength of both the XM satellite and terrestrial signals can be checked at menu “Input Setup” – “Antenna Aiming” (☞ page 36).

## Searching Categories

**1** Press ◀ ▶.



XM040 DeepTrks  
CAT: Rock ← Channel category

**2** Use ◀ ▶ to select the category, then use ▲ ▼ to select the desired station.

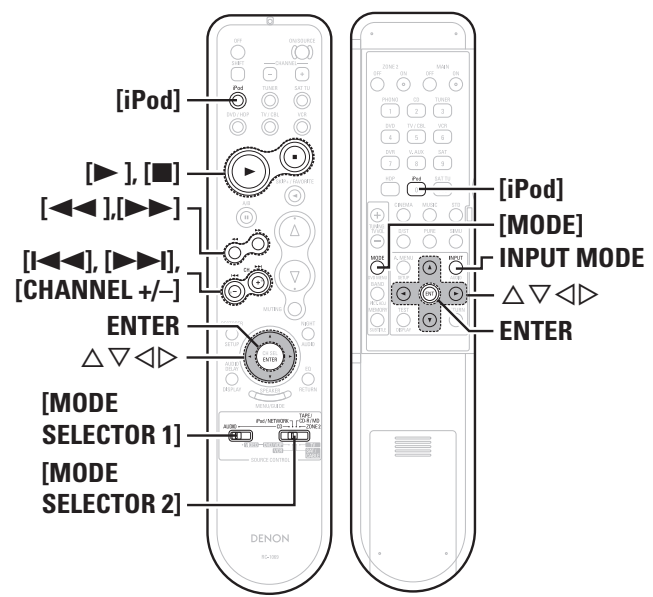
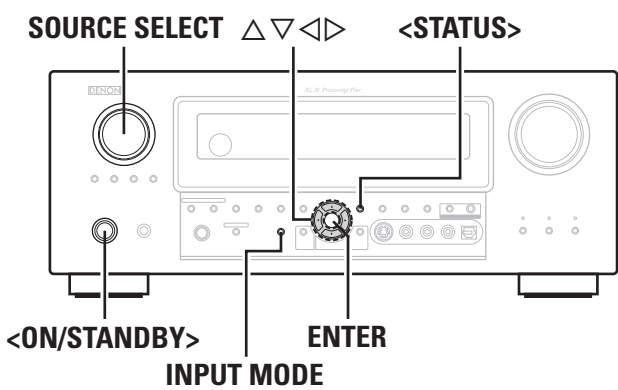

**About the button names in these explanations**

< > : Buttons on the main unit  
[ ] : Buttons on the remote control unit

**Button name only:**  
Buttons on the main unit and remote control unit

## iPod® Playback

The music on an iPod can be played by using the Control Dock for iPod (ASD-1R, sold separately). The operation can also be performed using the buttons on the main unit or remote control unit while watching the menus.

**Made for iPod** iPod is a trademark of Apple Inc., registered in the U.S. and other countries.

※ The iPod may only be used to copy or play contents that are not copyrighted or contents for which copying or playback is legally permitted for your private use as an individual. Be sure to comply with applicable copyright legislation.

### Basic Operation

- 1 Make the necessary preparations.**
  - Set the iPod in the DENON Control Dock for iPod. (See the Control Dock for iPod's operating instructions.)
  - Assign the Control Dock for iPod's input.

**MENU : "Input Setup" – "Assign" – "iPod dock"**  
(page 35)

- 2 Either turn <SOURCE SELECT> or press [iPod] to select the input source assigned in step 1-② above.**

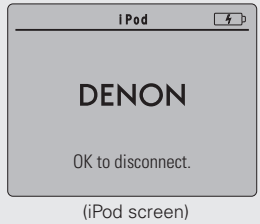

※ If the screens above are not displayed, the iPod may not be properly connected. Try connecting again.

- 3 Set [MODE SELECTOR 1] to "AUDIO" and [MODE SELECTOR 2] to "iPod/NETWORK".**  
(page 51 "Remote Control Unit Operations")

- With the default settings, the iPod can be used connected to the VCR (iPod) connector.
- Use the RESTORER mode to expand the low and high frequency components of compressed audio files and achieve a richer sound. The default setting is "Mode3".
- Press <ON/STANDBY> and set the AVR-988's power to the standby mode before disconnecting the iPod. Also switch the input source to one to which the menu "iPod dock" is not assigned before disconnecting the iPod.

**NOTE**

- Depending on the type of iPod and the software version, some functions may not operate.
- DENON will accept no responsibility whatsoever for any loss of iPod data.

### Listening to Music

- Use  $\Delta \nabla$  to select the menu, then press **ENTER** or  $\triangleright$  to select the music file to be played.
- Press **ENTER** or  $\triangleright$ . Playback starts.

**Stopping playback temporarily**  
During playback, press **ENTER** or  $\triangleright$ . Press again to resume playback.

**Fast-forwarding or fast-reversing**  
During playback, either press and hold  $\Delta$  (to fast-reverse) or  $\nabla$  (to fast-forward), or press  $\triangleleft \triangleleft$  or  $\triangleright \triangleright$ .

**To cue to the beginning of a track**  
During playback, either press  $\Delta$  (to cue to the previous track) or  $\nabla$  (to cue to the next track), or press  $\triangleleft \triangleleft$  or  $\triangleright \triangleright$ .

**To stop**  
During playback, either press and hold **ENTER** or press  $\blacksquare$ .

**Playing repeatedly**  
Press  $\text{[CHANNEL -]}$ .

**[Selectable items]** **All** **One** **Off**

**MENU : "Input Setup" – "iPod" – "Repeat"** (page 35)

## Shuffling playback

Press [CHANNEL +].

[Selectable items] **Albums** **Songs** **OFF**

**MENU** : "Input Setup" – "iPod" – "Shuffle" (☞ page 35)

### To switch between the Browse and Remote modes

Either press and hold [MODE].



- The title name, artist name and album name can be checked by pressing <STATUS> during playback.
- On the AVR-988, folder and file names can be displayed as titles. Any characters that cannot be displayed are replaced with " . (period)."
- The time for which the menus are displayed can be set at menu "Manual Setup" – "Option Setup" – "On-Screen Display" – "iPod Information" (☞ page 31).

## Viewing Still Pictures or Videos on the iPod

Photo and video data on the iPod can be viewed on the monitor. Only for iPod equipped with slideshow or video functions. (When using an ASD-1R)

### 1 Press and hold [MODE] to set the Remote mode.

"Remote iPod" is displayed on the AVR-988's display.

### 2 Watching the iPod's screen, use $\Delta$ $\nabla$ to select "Photos" or "Videos".

### 3 Press ENTER until the image you want to view is displayed.



"TV Out" at the iPod's "Slideshow Settings" or "Video Settings" must be set to "On" in order to display the iPod's photo data or videos on the monitor. For details, see the iPod's operating instructions.

# Other Operations and Functions

## Other Operations

### Playing Super Audio CD

#### 1 Assign the HDMI input connector at the "HDMI In" setting (☞ page 34).

#### 2 Either turn <SOURCE SELECT> or press [SOURCE SELECT] to select the input source assigned in step 1.

The "HDMI" indicator lights on the display.

#### 3 Use INPUT MODE to select "AUTO" (☞ page 34).

Select the input mode according to the program source to be played.

#### 4 Select the surround mode (☞ page 36, 37).

We recommend playing in the DIRECT mode.

#### 5 Start playing the Super Audio CD.

The "DSD" indicator lights on the display.

For operating instructions, refer to the respective equipment's operating instructions.



- When playing DSD signals in the DIRECT or PURE DIRECT mode, the DSD signals are converted as such into analog signals. When playing in other surround modes, the DSD signals are first converted into PCM format, then into analog signals.
- "DSD DIRECT" is shown on the display when playing DSD 2-channel signals in the DIRECT mode. "DSD MULTI DIRECT" is shown on the display when playing DSD multi-channel signals in the DIRECT mode.

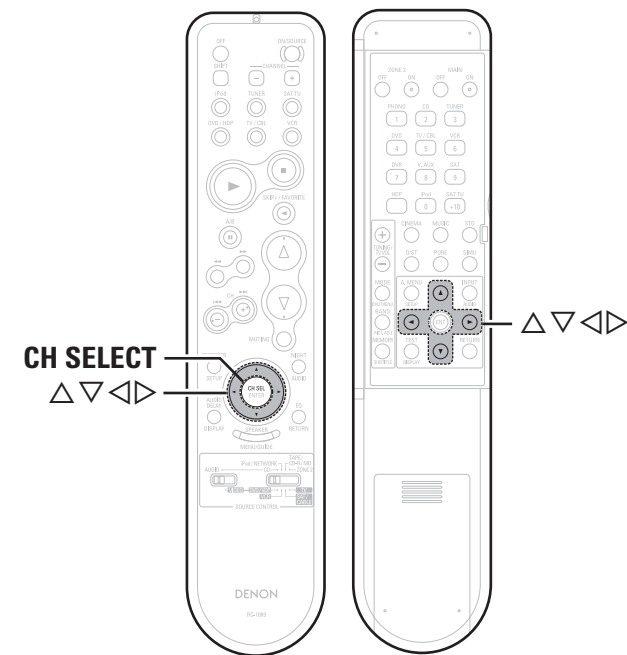
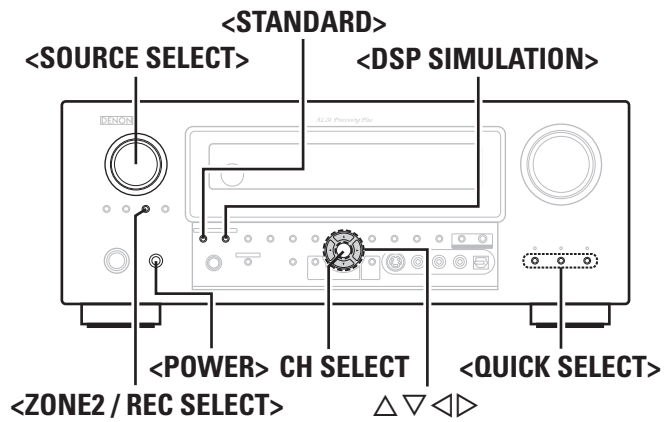

## Recording on an External Device (REC OUT mode)

You can listen to one program source while recording a different program source.

### 1 Press <ZONE2 / REC SELECT>.

"ZONE2 SOURCE" is shown on the display.

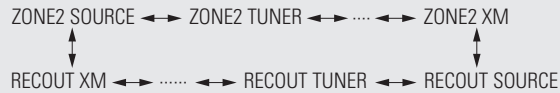

### 2 Turn <SOURCE SELECT> until "RECOUT SOURCE" is displayed.

The "REC" indicator lights.

### 3 Turn <SOURCE SELECT> to choose the input source to be recorded.

### 4 Play the program source.

For operating instructions, refer to the respective equipment's operating instructions.  
To record FM or AM broadcasts, select the broadcast (see page 44).

### 5 Start recording.

For operating instructions, refer to the respective equipment's operating instructions.



- To cancel, press <ZONE2 / REC SELECT>, then turn <SOURCE SELECT> until "ZONE2 SOURCE" is displayed.
- Make a test recording before starting the actual recording.
- Signals are only output to the analog REC OUT connectors when the digital signals input to the digital input connectors (OPTICAL/COAXIAL) are PCM (2-channel) signals.
- Digital audio signals input to the HDMI connectors are not output to the REC OUT connectors, so connect using the OPTICAL or COAXIAL connectors.
- Sources selected with the REC OUT mode are output from ZONE2 as well.
- In the REC OUT mode, the remote control unit's ZONE2 mode buttons cannot be operated.
- The "XM" digital audio output signals are not output from the OPTICAL2 or OPTICAL3 output connectors.

#### NOTE

- Recordings you make are for your personal enjoyment and should not be used for other purposes without permission of the copyright holder.
- Input sources for which "Delete" is selected at "Source Delete" cannot be selected.

#### About the button names in these explanations

- < > : Buttons on the main unit
- [ ] : Buttons on the remote control unit

#### Button name only:

Buttons on the main unit and remote control unit

## Convenient Functions

### Channel Level

You can adjust the channel level either according to the playback sources or to suit your taste, as described below.

#### 1 Press CH SELECT.

Channel Volume			
FL	◀ 0.0 dB	SR	0.0 dB
C	0.0 dB	SBR	0.0 dB
FR	0.0 dB	SBL	0.0 dB
SW	0.0 dB	SL	0.0 dB
Fader			
FRONT ◀ : ▶ REAR			

#### 2 Use △▽ or CH SELECT to select the speaker.

The speaker that can be set switches each time one of the buttons is pressed.

#### 3 Use ◀▶ to adjust the volume.

※ "OFF" can be set by pressing ◀ when the subwoofer's volume is set to -12 dB.

### Fader Function

This function lets you adjust (fade) the sound from all the front or rear speakers at once.

#### 1 Press CH SELECT.

#### 2 Press △▽ or CH SELECT to select "Fader".

#### 3 Use ◀▶ to adjust the volume of the speakers. (◀: front, ▶: rear)



- The fader function does not affect the subwoofer.
- The fader can be adjusted until the volume of the speaker adjusted to the lowest value is -12 dB.

### Quick Select Function

With this function, the currently playing input source, input mode, surround mode, room EQ settings and volume can be stored in the memory.

#### 1 Set the input source, input mode, surround mode, room EQ settings and volume to the conditions you want to store.

#### 2 Press and hold the desired <QUICK SELECT>. Keep pressing the button until the quick select indicator lights.

#### [Quick Select Defaults]

	Input Source	Volume
Quick Select 1	DVD	-40 dB
Quick Select 2	TV/CBL	-40 dB
Quick Select 3	VCR	-40 dB



- To call out the settings, press <QUICK SELECT> at which the desired settings were stored.
- The Quick Select name can be changed (☞ page 31).

#### NOTE

Input sources stored with the quick select function cannot be selected if they have been deleted at menu "Manual Setup" – "Option Setup" – "Source Delete" (☞ page 31). In this case, store them again.

### Personal Memory Plus Function

This function sets the settings (input mode, surround mode, etc.) last selected for the individual input sources.

When you switch to an input source, the settings are automatically set to the ones that were set the last time that input source was used.



The surround parameters, tone control, room EQ settings and the volumes of the different speakers are stored for the individual surround modes.

### Last Function Memory

This stores the settings as they were directly before the standby mode was set.

When the power is turned back on, the settings are restored to as they were directly before the standby mode was set.

### Backup Memory

The various settings are backed up for about 1 week, even if the power is turned off or the power cord is disconnected.

### Resetting the Microprocessor

Perform this procedure if the display is abnormal or if operations cannot be performed.

When the microprocessor is reset, all the settings are reset to their default values.

#### 1 Turn off the power using <POWER>.

#### 2 Press <POWER> while simultaneously pressing <STANDARD> and <DSP SIMULATION>.

#### 3 Once the display starts flashing at intervals of about 1 second, release the two buttons.



If in step 3 the display does not flash at intervals of about 1 second, start over from step 1.

# Remote Control Unit Operations

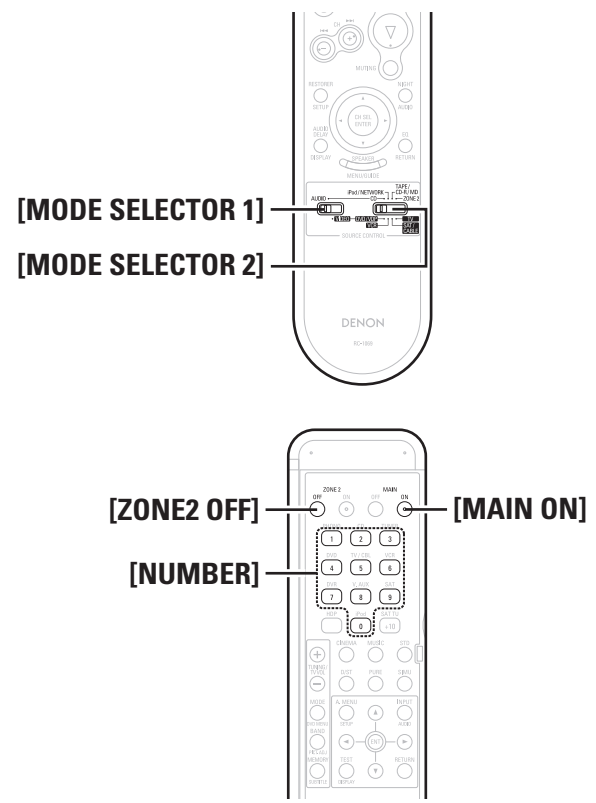

Depending on the model and year of manufacture of your equipment, some buttons may not operate.

## Operating DENON Audio Components

- 1** Set **[MODE SELECTOR 1]** to “AUDIO”.
- 2** Set **[MODE SELECTOR 2]** to the position for the component to be operated (CD, iPod/NETWORK or TAPE/CD-R/MD).
- 3** Operate the audio component.
  - ※ For details, refer to the component’s operating instructions.
  - ※ While this remote control is compatible with a wide range of infrared controlled components, it may be the case that some component models cannot be operated with this remote control.

## Presetting

- DENON and other makes of components can be operated by setting the preset memory.
- This remote control unit can be used to operate components of other manufacturers without using the learning function by registering the manufacturer of the component as shown in the list of preset codes (End of this manual).
- Operation is not possible for some models.

- 1** Set **[MODE SELECTOR 1]** to “AUDIO” or “VIDEO”.
  - ※ Set to the AUDIO side for the CD, TAPE/CD-R/MD position, and to the VIDEO side for the DVD/VDP, DBS/CABLE, VCR or TV position.
- 2** Set **[MODE SELECTOR 2]** to the component to be registered.
- 3** Press **[ZONE2 OFF]** and **[MAIN ON]** at the same time.
  - The indicator starts flashing.
- 4** Referring to the included list of preset codes, press **[NUMBER]** to input the preset code (a 3-digit number) for the manufacturer of the component whose signals you want to store in the memory.
- 5** To store the codes of another component in the memory, repeat steps 1 to 4.

- The signals for the pressed buttons are emitted while setting the preset memory. To avoid accidental operation, cover the remote control unit’s transmitting window while setting the preset memory.
- Depending on the model and year of manufacture, this function cannot be used for some models, even if they are of makes listed in the list of preset codes.
- Some manufacturers use more than one type of remote control code. Refer to the included list of preset codes to change the number and verify correct operation.
- The preset memory can be set for one component only among the following: TAPE/CD-R/MD, DVD/VDP and DBS/CABLE.

## Operating Preset Components

- 1** Set **[MODE SELECTOR 1]** to “AUDIO” or “VIDEO”.
  - ※ Set to the AUDIO side for the CD, TAPE/CD-R/MD position, and to the VIDEO side for the DVD/VDP, DBS/CABLE, VCR or TV position.
- 2** Set **[MODE SELECTOR 2]** to the component you want to operate.
- 3** Operate the component.
  - ※ For details, refer to the component’s operating instructions.
  - ※ Some models cannot be operated with this remote control unit.

## Functions of Buttons by Component

### □ Front

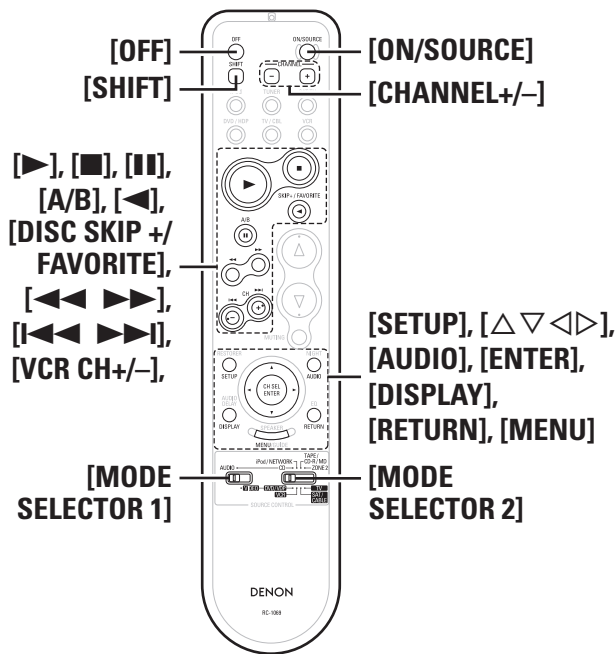

Device operated	CD Player	iPod	CD Recorder	MD Recorder	Tape Deck	DVD Player	Video disc player	Video Deck	Satellite Receiver	Cable TV	TV (Monitor)
<b>MODE SELECTOR 1</b>	<b>AUDIO</b>					<b>VIDEO</b>					
<b>MODE SELECTOR 2</b>	<b>CD</b>	<b>iPod / NETWORK</b>	<b>TAPE / CD-R / MD</b>			<b>DVD / VDP</b>		<b>VCR</b>	<b>DBS / CABLE</b>		<b>TV</b>
<b>OFF</b>	–	–	–	–	–	Power off	–	–	–	–	–
<b>ON/SOURCE</b>	–	–	–	–	–	Power on	Power on / Standby	Power on / Standby	Power on / Standby	Power on / Standby	Power on / Standby
<b>SHIFT</b>	Preset channel selection	Preset channel selection	Preset channel selection	Preset channel selection	Preset channel selection	–	–	–	–	–	–
<b>CHANNEL +</b>	Preset channel selection	1-track/Album shuffle play	Preset channel selection	Preset channel selection	Preset channel selection	Switch Channels (+)	Switch Channels (+)	Switch Channels (+)	Switch Channels (+)	Switch Channels (+)	Switch Channels (+)
<b>CHANNEL –</b>	Preset channel selection	1-track/All track repeat play	Preset channel selection	Preset channel selection	Preset channel selection	Switch Channels (–)	Switch Channels (–)	Switch Channels (–)	Switch Channels (–)	Switch Channels (–)	Switch Channels (–)
<b>▶</b>	Play	Play / Pause	Play	Play	Play	Play	Play	Play	Punch through	Punch through	Punch through
<b>■</b>	Stop	Stop	Stop	Stop	Stop	Stop	Stop	Stop			
<b>⏏, A/B</b>	Pause	–	Pause	Pause	A/B switching	Pause	Pause	Pause			
<b>◀, DISC SKIP +</b>	Disc skip +	–	–	–	Reverse play	Disc skip	–	–			
<b>◀▶▶▶</b>	Manual Search (fast-reverse / fast-forward)	Manual Search (fast-reverse / fast-forward)	Manual Search (fast-reverse / fast-forward)	Manual Search (fast-reverse / fast-forward)	Rewind / Fast forward	Manual Search (fast-reverse / fast-forward)	Manual Search (fast-reverse / fast-forward)	Manual Search (fast-reverse / fast-forward)	Manual Search (fast-reverse / fast-forward)	Manual Search (fast-reverse / fast-forward)	Manual Search (fast-reverse / fast-forward)
<b>◀▶▶▶▶</b>	Auto search (cue)	Auto search (cue)	Auto search (cue)	Auto search (cue)	–	Auto search (cue)	Auto search (cue)	Switch Channels (–, +)	–	–	–
<b>SETUP</b>	–	–	–	–	–	Setup	–	–	–	–	–
<b>△ ▽ ◀ ▶</b>	–	Cursor	–	–	–	Cursor operation	–	–	Cursor operation	Cursor operation	Cursor operation
<b>AUDIO</b>	–	–	–	–	–	Switching the audio signal	–	–	–	–	–
<b>ENTER</b>	–	Enter	–	–	–	Enter setting	–	–	Enter setting	Enter setting	Enter setting
<b>DISPLAY</b>	–	–	–	–	–	Display of currently playing disc information	–	–	Display of currently playing disc information	Display of currently playing disc information	Display of currently playing disc information
<b>RETURN</b>	–	–	–	–	–	Return	–	–	Return	Return	Return
<b>MENU</b>	–	–	–	–	–	Calling out the menus	–	–	Calling out the menus	Calling out the menus	Calling out the menus

□ Rear

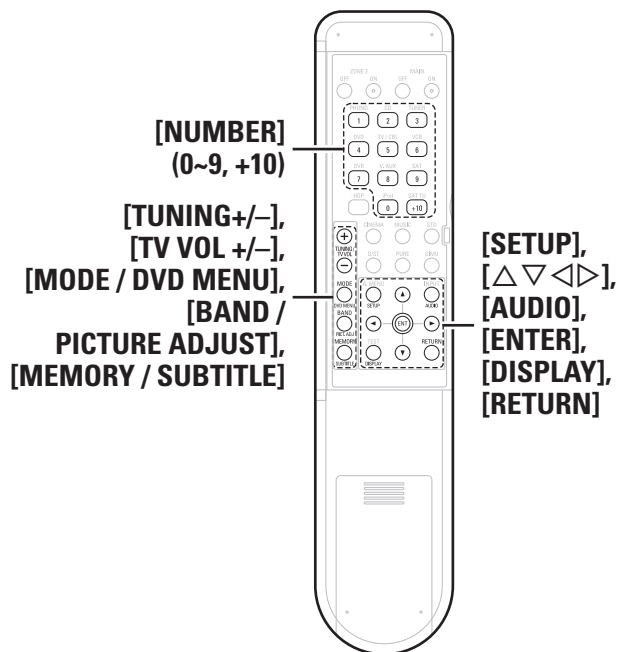

Device operated	CD Player	iPod	CD Recorder	MD Recorder	Tape Deck	DVD Player	Video disc player	Video Deck	Satellite Receiver	Cable TV	TV (Monitor)
<b>MODE SELECTOR 1</b>	<b>AUDIO</b>					<b>VIDEO</b>					
<b>MODE SELECTOR 2</b>	<b>CD</b>	<b>iPod / NETWORK</b>	<b>TAPE / CD-R / MD</b>			<b>DVD / VDP</b>		<b>VCR</b>	<b>DBS / CABLE</b>		<b>TV</b>
<b>NUMBER (0 ~ 9, +10)</b>	-	-	-	-	-	Number input / Track selection	Number input / Track selection	-	Channels	Channels	Channels
<b>TV / VCR</b>	-	-	-	-	-	Switch inputs	Switch inputs	Switch inputs	Switch inputs	Switch inputs	Switch inputs
<b>TUNING (+, -) / TV VOL (+, -)</b>	Tuning (+, -)	Tuning (+, -)	Tuning (+, -)	Tuning (+, -)	Tuning (+, -)	Volume control (+, -)	Volume control (+, -)	Volume control (+, -)	Volume control (+, -)	Volume control (+, -)	Volume control (+, -)
<b>MODE / MENU</b>	Switch search modes	Switch search modes / Browse / Remote mode switching (Press and hold)	Switch search modes	Switch search modes	Switch search modes	Calling out the menus	-	-	Calling out the menus	Calling out the menus	Calling out the menus
<b>SETUP</b>	-	-	-	-	-	Setup	-	-	-	-	-
<b>Δ ▽ ◀ ▶</b>	-	-	-	-	-	Cursor operation	-	-	Cursor operation	Cursor operation	Cursor operation
<b>AUDIO BAND / PICTURE ADJUST</b>	-	-	-	-	-	Audio	-	-	-	-	-
<b>ENTER</b>	-	-	-	-	-	Enter setting	-	-	Enter setting	Enter setting	Enter setting
<b>MEMORY / SUBTITLE</b>	Preset memory	Preset memory	Preset memory	Preset memory	Preset memory	Subtitle	-	-	-	-	-
<b>DISPLAY</b>	-	-	-	-	-	Display of currently playing disc information	-	-	Display of currently playing disc information	Display of currently playing disc information	Display of currently playing disc information
<b>RETURN</b>	-	-	-	-	-	Return	-	-	Return	Return	Return
<b>Default setting (Preset code)</b>	DENON (111)	-	DENON (151)	-	-	DENON (111)	-	HITACHI (108)	-	ABC (007)	HITACHI (134)
<b>Special Remarks</b>	①	-	①			①, ②		①	①, ③		①, ③

**[Special Remarks]**

- ① Only one device can be set in the preset memory for each mode. Also, when a new code is preset, the previous code is automatically deleted.
- ② For some brands, the DVD remote control buttons may have different function names. Check beforehand.
- ③ One of the following buttons can be assigned to the TV and satellite receiver or cable TV: CD, TAPE/CD-R/MD, VCR, DVD/VDP (page 54 "Setting the punch through function").



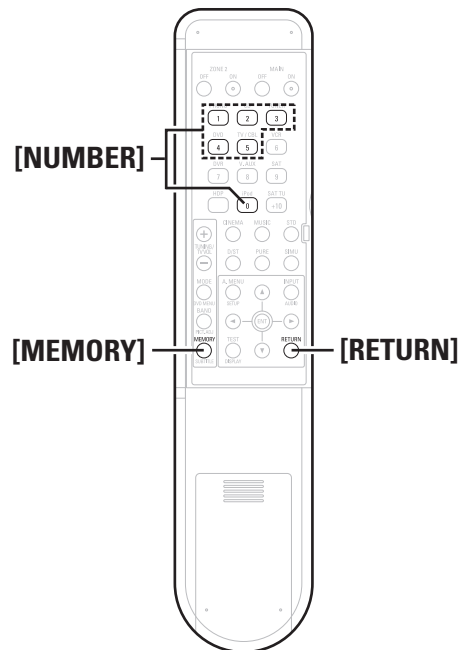
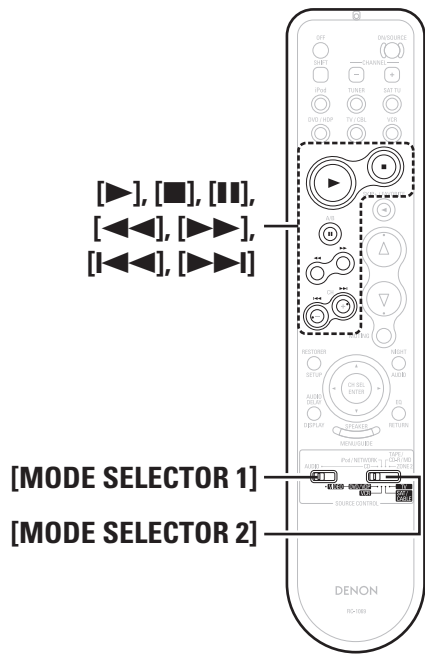

## Punch Through Function

"Punch Through" is a function allowing you to operate ►, ■, ||, ◀◀, ▶▶, ◀◀▶ and ▶▶◀ on CD, TAPE, CD-R/MD, DVD/VDP or VCR components when in the DBS/CABLE or TV mode. By default, nothing is set.

- 1** Set [MODE SELECTOR 1] to "VIDEO".
- 2** Set [MODE SELECTOR 2] to the component to be registered (DBS/CABLE or TV).
- 3** Press [MEMORY] and [RETURN] at the same time. The indicator starts flashing.
- 4** Input the number of the component you want to set.

	No.
CD	1
iPod/NETWORK	2
TAPE/CD-R/MD	3
DVD/VDP	4
VCR	5
No setting	0

# Amp Assign / Multi-zone Connections and Operations

The AVR-988 is compatible with the following types of playback:

- **Multi-zone playback (ZONE2)**
- **Bi-amp playback (front speakers)**

## NOTE

- For bi-amp playback, use speakers compatible with that type of connection.
- When conducting bi-amp playback, remove the short-circuiting boards (or wires) from the speaker terminals.

## Multi-zone Settings with the Amp Assign Function

The amp assign function lets you assign the amplifiers for the different channels built into the AVR-988 to the speaker outputs for the different zones.

Select the desired playback environment from among "Setting 1" to "Setting 4," then set the corresponding "Amp Assign" mode at menu "Manual Setup" – "Option Setup" – "Amp Assign" (page 30).

Connect the speakers as described at "Amp Assign mode settings and speakers connected to the various speaker terminals".



"Setting 3" is possible to switch the Amp Assign mode between the 5.1-channel mode and 2-channel mode without changing the speaker connections.

## Setting 1 :

### ● Multi-zone playback

- 5.1-channel playback + ZONE2 stereo playback
- 5.1-channel playback + ZONE2 monaural playback

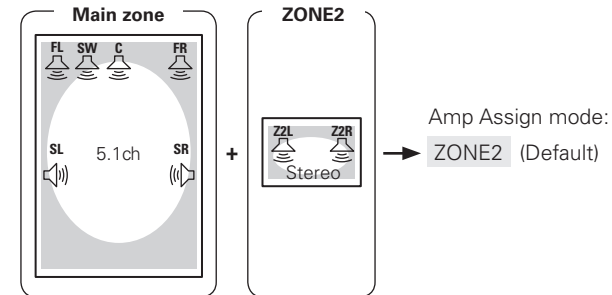

### □ Amp Assign mode setting and speakers connected to the various speaker terminals

Speaker terminal	FRONT		CENTER	SURR		SURR. BACK / AMP ASSIGN	
	R	L		R	L	R	L
Amp Assign mode							
ZONE2	FR	FL	C	SR	SL	Z2R	Z2L

**Setting 2 :**  
**● 7.1-channel playback**

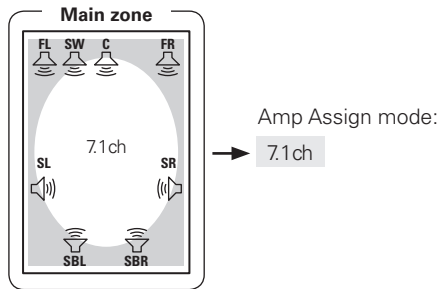

**Amp Assign mode setting and speakers connected to the various speaker terminals**

Speaker terminal \ Amp Assign mode	FRONT		CENTER	SURR		SURR. BACK / AMP ASSIGN	
	R	L		R	L	R	L
7.1ch	FR	FL	C	SR	SL	SBR	SBL

**Setting 3 :** With this setting it is possible to switch between the following two playback modes.  
**● 5.1-channel playback**  
**● 2-channel playback**  
**Switching** ..... Surround Mode switching

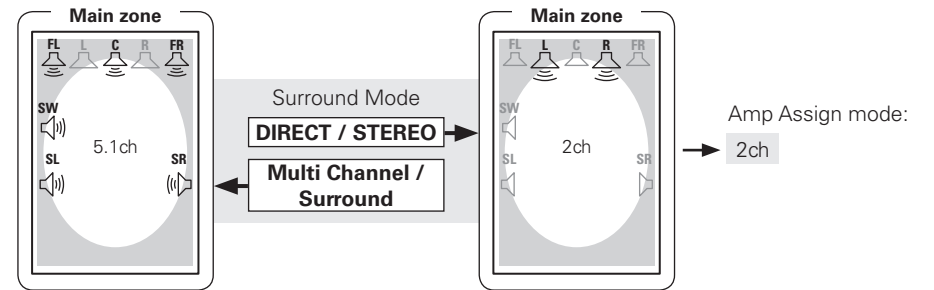

**Amp Assign mode setting and speakers connected to the various speaker terminals**

Speaker terminal \ Amp Assign mode	FRONT		CENTER	SURR		SURR. BACK / AMP ASSIGN	
	R	L		R	L	R	L
2ch	FR	FL	C	SR	SL	FR	FL

### Setting 4 :

● Making bi-amp connections for the FL and FR channels in the main zone and conducting 5.1-channel playback (switching with other modes not possible)

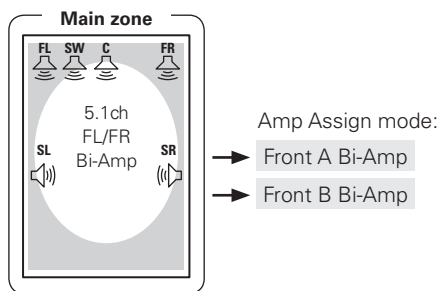

□ Amp Assign mode setting and speakers connected to the various speaker terminals

Speaker terminal	FRONT-A		FRONT-B		CENTER	SURR		SURR. BACK / AMP ASSIGN	
	R	L	R	L		R	L	R	L
Amp Assign mode								FR	FL
Front A Bi-Amp								FL-A/FR-A Bi-Amp connection	
Front B Bi-Amp	FR-A	FL-A	FR-B	FL-B	C	SR	SL	FL-B/FR-B Bi-Amp connection	

## Multi-zone Settings and Operations with Zone Pre-out Output

Prepare power amplifiers for ZONE2.

	Connectors for audio output	Audio signals	Connectors for video output
ZONE2	ZONE2 PRE OUT	Stereo	ZONE2 VIDEO OUT

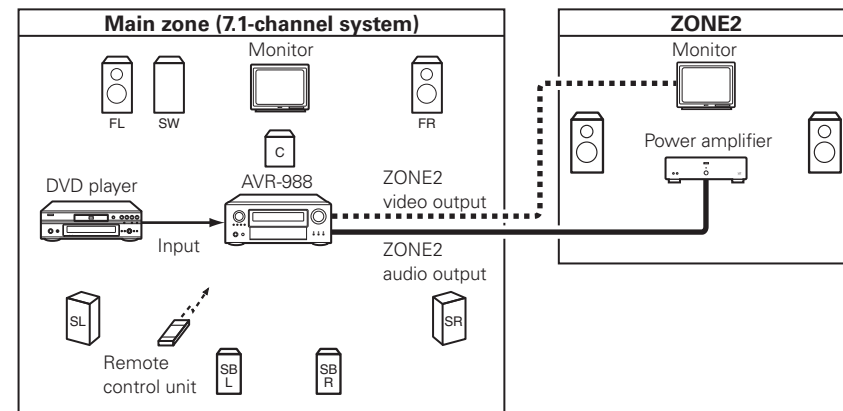

----- : Multi-zone video cable  
 \_\_\_\_\_ : Multi-zone audio cable

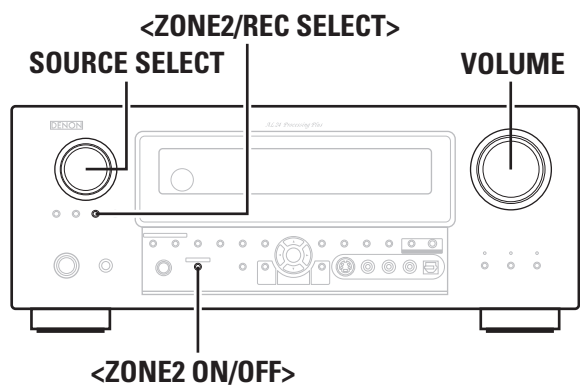

## Multi-zone Operations

### Turning the Power On and Off

#### [Operation on the main unit]

- 1 Press **<ZONE2 ON/OFF>**.
- 2 When the power turns on, the multi-zone indicator ( **Z2** ) lights on the display.

#### [Operation on the remote control unit]

- 1 Set **[MODE SELECTOR 1]** to "AUDIO" and **[MODE SELECTOR 2]** to "ZONE2".
- 2 Press **[ZONE2 ON]** or **[ZONE2 OFF]**.



When using ZONE2, it is possible to turn the power for the MAIN ZONE only on or off by pressing **[MAIN ON]** or **[MAIN OFF]**.

### Selecting the Input Source

#### [Operation on the main unit]

- 1 Press **<ZONE2 / REC SELECT>**.
- 2 Turn **<SOURCE SELECT>** and select the ZONE2's input source.

#### [Operation on the remote control unit]

- 1 Set **[MODE SELECTOR 1]** to "AUDIO" and **[MODE SELECTOR 2]** to "ZONE2".
- 2 Press **[SOURCE SELECT]**.

### Adjusting the Volume

#### [Operation on the main unit]

- 1 Press **<ZONE2 / REC SELECT>**.
- 2 Turn **<VOLUME>** to adjust.

#### [Operation on the remote control unit]

- 1 Set **[MODE SELECTOR 1]** to "AUDIO" and **[MODE SELECTOR 2]** to "ZONE2".
- 2 Press **[VOLUME]**.

**[Variable range]** --- **-70dB** ~ **-40dB** ~ **+18dB**



The volume can be adjusted when menu "Manual Setup" – "Zone2 Setup" – "Volume Level" is set to "VAR." The volume can be increased up to the value set at menu "Manual Setup" – "Zone2 Setup" – "Volume Limit" (page 30).

### Turning off the Sound Temporarily

- 1 Set **[MODE SELECTOR 1]** to "AUDIO" and **[MODE SELECTOR 2]** to "ZONE2".

#### 2 Press **[MUTING]**.

The sound is reduced to the level set at menu "Manual Setup" – "Zone2 Setup" – "Mute Level" (page 30).

To cancel, either adjust the volume or press **[MUTING]** again. The setting is canceled when the zone's power is turned off.



The source selected for ZONE2 is also output from the recording output connectors.

#### NOTE

- When the input source to which the digital input connectors (OPTICAL/COAXIAL) are assigned is selected in ZONE2, playback is only possible if the digital signal being input is in PCM (2-channel) format.
- Digital audio signals input from the HDMI connectors cannot be played in multi-zone.
- When certain digital signals are being input, noise may be output from the ZONE2 audio output connectors.

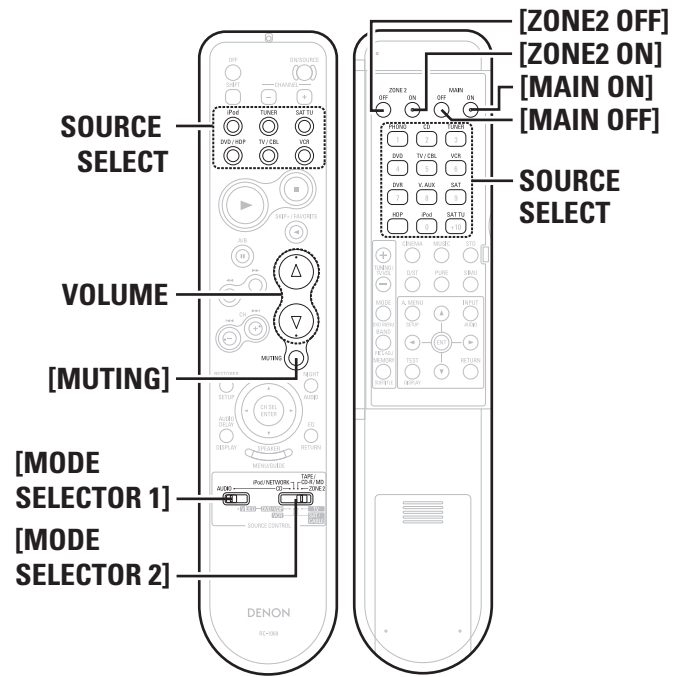

**About the button names in these explanations**  
 < > : Buttons on the main unit  
 [ ] : Buttons on the remote control unit  
**Button name only:**  
 Buttons on the main unit and remote control unit

# Other Information

## About Speaker Installation

### Surround back speakers

Sound positioning directly to the rear can be achieved easily by adding a surround back speaker to a 5.1-channel system. In addition, the acoustic image extending between the sides and the rear is narrowed, thus greatly improving the expression of the surround signals for sounds moving from the sides to the back and from the front to the point directly behind the listening position.

#### Change of positioning and acoustic image with 5.1-channel systems

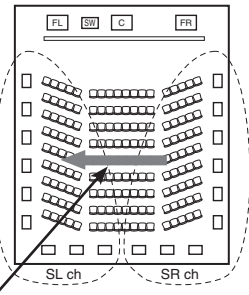

Movement of acoustic image from SR to SL

#### Change of positioning and acoustic image with 6.1-channel systems

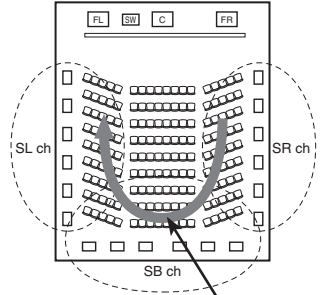

Movement of acoustic image from SR to SB to SL

In addition to sources recorded in 6.1-channels, the surround effect of conventional 2- to 5.1-channel sources can also be enhanced.

### Number of surround back speakers

We recommend using 2 speakers. When using dipolar speakers in particular, be sure to use 2 speakers.

### Placement of the surround left and right channels when using surround back speakers

We recommend installing the speakers for the surround "L" and "R" channels a bit forward.

### Examples of speaker layouts

Below we introduce examples of speaker layouts. Refer to these to arrange your speakers according to their type and how you want to use them.

#### [1] Using surround back speaker(s)

##### ① When mainly playing movies

Recommended when your surround speakers are single or 2-way speakers.

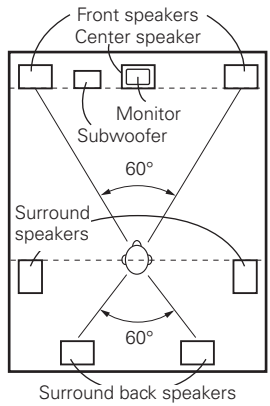

[As seen from above]

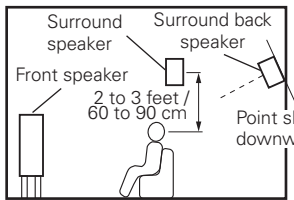

[As seen from the side]

##### ② Setting for primarily watching movies using diffusion type speakers for the surround speakers

For the greatest sense of surround sound envelopment, diffuse radiation speakers such as bipolar types, or dipolar types, provide a wider dispersion than is possible to obtain from a direct radiating speaker (monopolar). Place these speakers at either side of the prime listening position, mounted above ear level.

#### Path of the surround sound from the speakers to the listening position

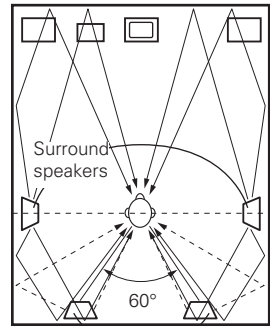

[As seen from above]

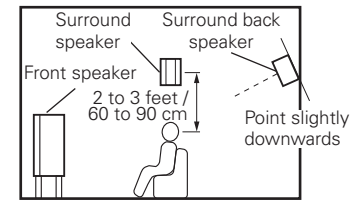

[As seen from the side]

##### ③ When playing movies and music

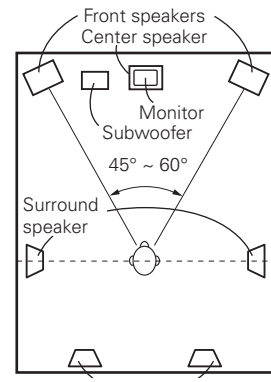

[As seen from above]

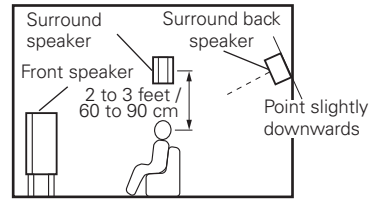

[As seen from the side]

## [2] When not using surround back speakers

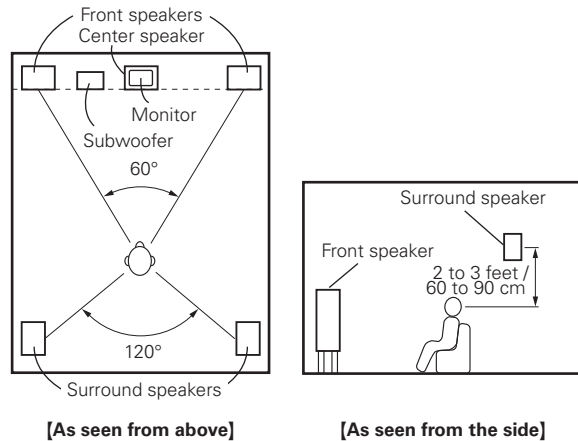

## Surround

The AVR-988 is equipped with a digital signal processing circuit that lets you play program sources in the surround mode to achieve the same sense of presence as in a movie theater.

## Dolby Surround

### Dolby Digital

Dolby Digital is a multichannel digital signal format developed by Dolby Laboratories.

A total of 5.1-channels are played: 3 front channels ("FL", "FR" and "C"), 2 surround channels ("SL" and "SR") and the "LFE" channel for low frequencies.

Because of this, there is no crosstalk between channels and a realistic sound field with a "three-dimensional" feeling (sense of distance, movement and positioning) is achieved.

A real, overpowering sense of presence is achieved when playing movie sources in AV rooms as well.

### Dolby Digital Plus

Dolby Digital Plus is an improved Dolby Digital signal format that is compatible with up to 7.1-channels of discrete digital sound and also improves sound quality thanks to extra data bit rate performance. It is upwardly compatible with conventional Dolby Digital, so it offers greater flexibility in response to the source signal and the conditions of the playback equipment.

## Dolby TrueHD

Dolby TrueHD is a high definition audio technology developed by Dolby Laboratories, using lossless coding technology to faithfully reproduce the sound of the studio master.

This format is compatible with a maximum sampling frequency of 96 kHz and up to 7.1-channels, so it is used for applications particularly prioritizing sound quality.

## Dolby Pro Logic II

Dolby Pro Logic II is a matrix decoding technology developed by Dolby Laboratories.

Regular music such as that on CDs is encoded into 5-channels to achieve an excellent surround effect.

The surround channel signals are converted into stereo and full band signals (with a frequency response of 20 Hz to 20 kHz or greater) to create a "three-dimensional" sound image offering a rich sense of presence for all stereo sources.

## Dolby Pro Logic IIx

Dolby Pro Logic IIx is a further improved version of the Dolby Pro Logic II matrix decoding technology.

Audio signals recorded in 2-channels are decoded to achieve a natural sound with up to 7.1-channels.

There are 3 modes: "Music" suited for playing music, "Cinema" suited for playing movies, and "Game" which is optimized for playing games.

### ※ Sources recorded in Dolby Surround

Sources recorded in Dolby Surround are indicated with the following logo marks.

Dolby Surround support mark : 

Manufactured under license from Dolby Laboratories.  
"Dolby," "Pro Logic" and the double-D symbol are trademarks of Dolby Laboratories.

## DTS Surround

### DTS Digital Surround

DTS Digital Surround is the standard digital surround format of DTS, Inc., compatible with a sampling frequency of 44.1 or 48 kHz and up to 5.1-channels of digital discrete surround sound.

### DTS-HD High Resolution Audio

DTS-HD High Resolution Audio is an improved version of the conventional DTS, DTS-ES and DTS 96/24 signals formats, compatible with sampling frequencies of 96 or 48 kHz and up to 7.1-channels of discrete digital sound. High data bit rate performance provides high quality sound. This format is fully compatible with conventional products, including conventional DTS digital surround 5.1-channel data.

### DTS-HD Master Audio

DTS-HD Master Audio is DTS, Inc.'s lossless audio format compatible with up to 96 kHz/7.1-channels. The lossless audio coding technology faithfully reproduces the sound of the studio master. It is fully compatible with conventional products, including conventional DTS digital surround 5.1-channel data.

### DTS-ES™ Discrete 6.1

DTS-ES™ Discrete 6.1 is a 6.1-channel discrete digital audio format adding a surround back (SB) channel to the DTS digital surround sound. Decoding of conventional 5.1-channel audio signals is also possible according to the decoder.

### DTS-ES™ Matrix 6.1

DTS-ES™ Matrix 6.1 is a 6.1-channel discrete digital audio format inserting a surround back (SB) channel to the DTS digital surround sound through matrix encoding. Decoding of conventional 5.1-channel audio signals is also possible according to the decoder.

### DTS NEO:6™ Surround

DTS NEO:6™ is a matrix decoding technology for achieving 6.1-channel surround playback with 2-channel sources. It includes "DTS NEO:6 CINEMA" suited for playing movies and "DTS NEO:6 MUSIC" suited for playing music.

## DTS 96/24

DTS 96/24 is a digital audio format enabling high sound quality playback in 5.1-channels with a sampling frequency of 96 kHz and 24 bit quantization on DVD-Video.

Manufactured under license under U.S. Patent #'s: 5,451,942; 5,956,674; 5,974,380; 5,978,762; 6,226,616; 6,487,535 & other U.S. and worldwide patents issued & pending. DTS is a registered trademark and the DTS logos, Symbol, DTS-HD and DTS-HD Master Audio are trademarks of DTS, Inc.© 1996-2007 DTS, Inc. All Rights Reserved.

## Neural Surround

Neural Surround™, a breakthrough in audio technology, will bring the excitement of surround music to more of America's listening audience. It provides the rich envelopment and discrete image detail of surround sound in a format 100 % compatible with stereo. With superior spectral resolution and channel separation, Neural Surround™ draws the brain's attention to sonic details in musical instruments, vocals, and ambience that are typically masked by other playback systems. This allows the listener to fully experience the richness and subtleties in recorded performance as never before. As the chosen format for XM Satellite Radio's new XM HD surround programming, Neural Surround will help deliver more surround music to more listeners than any other broadcast format. XM Satellite Radio will be the first radio company to broadcast surround sound on the radio 24 hours a day and will offer three channels fully dedicated to Neural Surround™ music. This alone will amount to more than 25,000 hours of Neural Surround™ music each year.



This product is manufactured under license from Neural Audio Corporation.

D&M Holdings Inc. hereby grants the user a non-exclusive, nontransferable, limited license right exercisable to use the NA SURROUND Technology and other US and World Wide Patents Pending technology.

"Neural" and "Neural Audio" and "Neural Surround" are trademarks of Neural Audio Corporation. All Rights Reserved.

## Audyssey MultEQ® XT

Audyssey MultEQ® XT is the first technology to properly measure sound information throughout a listening area, then combine this information to accurately represent the acoustical problems in the room. Based on these measurements, MultEQ XT calculates an equalization solution that corrects for both time and frequency response problems in every seat.

Audyssey MultEQ XT not only corrects frequency response problems in a large listening area but also performs a fully automated surround system setup.

For a detailed description, see page 23.



Audyssey MultEQ® XT is a trademark of Audyssey Laboratories. It is licensed under U.S. and National Patent Applications 20030235318 and 10/700,220. Additional U.S. and Foreign Patents pending. MultEQ XT and the Audyssey MultEQ XT logo are trademarks of Audyssey Laboratories, Inc. All rights reserved.

## AL24 Processing Plus

### AL24 Processing for All Channels

DENON has further developed its proprietary AL24 Processing, an analog waveform reproduction technology, to support the 192-kHz sampling frequency of DVD-Audio. AL24 Processing Plus, thoroughly suppresses quantization noise associated with D/A conversion of LPCM signals to reproduce the low-level signals with optimum clarity that will bring out all the delicate nuances of the music.

Equipped for not only front left and right channels but also for the surround left and right, center and subwoofer channels.

## HDMI (High-Definition Multimedia Interface)

HDMI is a digital interface standard for next generation TVs based on DVI (Digital Visual Interface) standards and optimized for use in consumer equipment.

Non-compressed digital video and multi-channel audio signals are transmitted with a single connection.

HDMI is also compatible with HDCP (High-bandwidth Digital Contents Protection), a technology for protecting copyrights that encrypts digital video signals in the same way as with DVI.

## Deep Color

Eliminates on-screen color banding, for smooth tonal transitions and subtle gradations between colors.

Enables increased contrast ratio.

Can represent many times more shades of gray between black and white.

At 30-bit pixel depth, a four times improvement would be the minimum, and the typical improvement would be eight times or more.

## xvYCC

Next-generation "xvYCC" color space supports 1.8 times as many colors as existing HDTV signals.

Lets HDTVs display colors more accurately.

Enables displays with natural, vivid colors.

## Lip Sync

Because consumer electronics devices are using increasingly complex digital signal processing to enhance the clarity and detail of the content, synchronization of video and audio in user devices has become a greater challenge and could potentially require complex end-user adjustments. HDMI 1.3 incorporates an automatic video/audio synching capability that allows devices to perform this synchronization automatically with total accuracy.

"HDMI"; "HDMI logo" and "High-Definition Multimedia Interface" are trademarks or registered trademarks of HDMI Licensing LLC.



## Surround Modes and Parameters

Surround mode	Signals and adjustability in the different modes									
	Channel output					Parameter (default values are shown in parentheses)				
	Front L/R	Center	Surround L/R	Surround Back L/R	Subwoofer	D. COMP *1	LFE *2	AFDM *1	SB CH OUT	CINEMA EQ.
PURE DIRECT, DIRECT	○	×	×	×	⊙	○ (OFF)	○ (0 dB)	×	×	×
DSD DIRECT	○	×	×	×	×	×	×	×	×	×
DSD MULTI DIRECT	○	⊙	⊙	⊙	⊙	×	○ (0 dB)	×	○	×
MULTI CH DIRECT	○	⊙	⊙	⊙	⊙	×	○ (0 dB)	○ (ON)	○	×
STEREO	○	×	×	×	⊙	○ (OFF)	○ (0 dB)	×	×	×
EXT. IN	○	⊙	⊙	⊙	⊙	×	×	×	×	×
MULTI CH IN	○	⊙	⊙	⊙	⊙	×	○ (0 dB)	○ (ON)	○	×
WIDE SCREEN	○	⊙	⊙	⊙	⊙	○ (OFF)	○ (0 dB)	×	○	○ (OFF)
DOLBY PRO LOGIC IIx	○	⊙	⊙	⊙	⊙	○ (OFF)	×	×	○	○ (NOTE1)
DOLBY PRO LOGIC II	○	⊙	⊙	×	⊙	○ (OFF)	×	×	○	○ (NOTE2)
DTS NEO:6	○	⊙	⊙	⊙	⊙	○ (OFF)	×	×	○	○ (NOTE1)
DOLBY DIGITAL	○	⊙	⊙	⊙	⊙	○ (OFF)	○ (0 dB)	○ (ON)	○	○ (OFF)
DTS SURROUND	○	⊙	⊙	⊙	⊙	○ (OFF)	○ (0 dB)	○ (ON)	○	○ (OFF)
neural	○	⊙	⊙	⊙	⊙	×	×	×	○	×
7CH STEREO	○	⊙	⊙	⊙	⊙	○ (OFF)	○ (0 dB)	×	○	×
SUPER STADIUM	○	⊙	⊙	⊙	⊙	○ (OFF)	○ (0 dB)	×	○	×
ROCK ARENA	○	⊙	⊙	⊙	⊙	○ (OFF)	○ (0 dB)	×	○	×
JAZZ CLUB	○	⊙	⊙	⊙	⊙	○ (OFF)	○ (0 dB)	×	○	×
CLASSIC CONCERT	○	⊙	⊙	⊙	⊙	○ (OFF)	○ (0 dB)	×	○	×
MONO MOVIE	○	⊙	⊙	⊙	⊙	○ (OFF)	○ (0 dB)	×	○	×
VIDEO GAME	○	⊙	⊙	⊙	⊙	○ (OFF)	○ (0 dB)	×	○	×
MATRIX	○	⊙	⊙	⊙	⊙	○ (OFF)	○ (0 dB)	×	○	×
VIRTURL	○	×	×	×	⊙	○ (OFF)	○ (0 dB)	×	×	×

○ : Signal / Adjustable  
 × : No signal / Not adjustable  
 ⊙ : Turned on or off by speaker configuration setting

○ : Enable  
 × : Unable  
 NOTE1 : This parameter is available when the menu "Parameter" – "Surround Parameter" – "MODE" is set to "CINEMA" (page 38).  
 NOTE2 : This parameter is available when the menu "Parameter" – "Surround Parameter" – "MODE" is set to "CINEMA" or "PL" (page 38).  
**NOTE:**  
 \*1 : When playing Dolby Digital and DTS signals.  
 \*2 : When playing Dolby Digital, DTS, DVD-Audio and Super Audio CD.

Surround mode	Signals and adjustability in the different modes														
	Parameter (default values are shown in parentheses)														
	MODE	ROOM SIZE	LEVEL	DELAY TIME	Subwoofer	PRO LOGIC II/IIx MUSIC mode only			NEO:6 MUSIC mode only	EXT. IN only	Tone Control	Night Mode	Room EQ	RESTORER	
PANORAMA						DIMENSION	CENTER WIDTH	CENTER IMAGE	SUBWOOFER ATT.						
PURE DIRECT, DIRECT	×	×	×	×	○	×	×	×	×	×	×	○ (OFF)	○ (NOTE5)	○	
DSD DIRECT	×	×	×	×	○	×	×	×	×	×	×	×	×	×	
DSD MULTI DIRECT	×	×	×	×	×	×	×	×	×	×	×	×	×	×	
MULTI CH DIRECT	×	×	×	×	×	×	×	×	×	×	×	○ (OFF)	○ (NOTE5)	×	
STEREO	×	×	×	×	×	×	×	×	×	×	○ (0 dB)	○ (OFF)	○ (OFF)	○	
EXT. IN	×	×	×	×	×	×	×	×	×	○	×	×	×	×	
MULTI CH IN	×	×	×	×	×	×	×	×	×	×	○ (0 dB)	○ (OFF)	○ (OFF)	×	
WIDE SCREEN	×	×	○ (ON, 10)	×	×	×	×	×	×	×	○ (0 dB)	○ (OFF)	○ (OFF)	○	
DOLBY PRO LOGIC IIx	○ (CINEMA)	×	×	×	×	○ (OFF)	○ (3)	○ (3)	×	×	○ (0 dB)	○ (OFF)	○ (OFF)	○	
DOLBY PRO LOGIC II	○ (CINEMA)	×	×	×	×	○ (OFF)	○ (3)	○ (3)	×	×	○ (0 dB)	○ (OFF)	○ (OFF)	○	
DTS NEO:6	○ (CINEMA)	×	×	×	×	×	×	×	○ (0.3)	×	○ (0 dB)	○ (OFF)	○ (OFF)	○	
DOLBY DIGITAL	×	×	×	×	×	×	×	×	×	×	○ (0 dB)	○ (OFF)	○ (OFF)	×	
DTS SURROUND	×	×	×	×	×	×	×	×	×	×	○ (0 dB)	○ (OFF)	○ (OFF)	×	
neural	×	×	×	×	×	×	×	×	×	×	○ (0 dB)	○ (OFF)	○ (OFF)	○	
7CH STEREO	×	×	×	×	×	×	×	×	×	×	○ (0 dB)	○ (OFF)	○ (OFF)	○	
SUPER STADIUM	×	○ (medium)	○ (10)	×	×	×	×	×	×	×	○ (NOTE3)	○ (OFF)	○ (OFF)	○	
ROCK ARENA	×	○ (medium)	○ (10)	×	×	×	×	×	×	×	○ (NOTE4)	○ (OFF)	○ (OFF)	○	
JAZZ CLUB	×	○ (medium)	○ (10)	×	×	×	×	×	×	×	○ (0 dB)	○ (OFF)	○ (OFF)	○	
CLASSIC CONCERT	×	○ (medium)	○ (10)	×	×	×	×	×	×	×	○ (0 dB)	○ (OFF)	○ (OFF)	○	
MONO MOVIE	×	○ (medium)	○ (10)	×	×	×	×	×	×	×	○ (0 dB)	○ (OFF)	○ (OFF)	○	
VIDEO GAME	×	○ (medium)	○ (10)	×	×	×	×	×	×	×	○ (0 dB)	○ (OFF)	○ (OFF)	○	
MATRIX	×	×	×	○ (30 ms)	×	×	×	×	×	×	○ (0 dB)	○ (OFF)	○ (OFF)	○	
VIRTURL	×	×	×	×	×	×	×	×	×	×	○ (0 dB)	○ (OFF)	○ (OFF)	○	

○ : Signal / Adjustable  
 × : No signal / Not adjustable  
 ◎ : Turned on or off by speaker configuration setting

○ : Adjustable  
 × : Not adjustable  
 NOTE3 : BASS +6 dB, TREBLE 0 dB  
 NOTE4 : BASS +6 dB, TREBLE +4 dB  
 NOTE5 : Can be used according to the "Direct Mode" setting.

## Differences in Surround Mode Names Depending on the Input Signals

Button	Surround mode	Note	Input signals														
			ANALOG	LINEAR PCM	DTS				DOLBY DIGITAL					DVD-AUDIO		Super Audio CD	
					DTS ES DSCRT (With Flag)	DTS ES MTRX (With Flag)	DTS (5.1ch)	DTS 96/24	DOLBY DIGITAL EX (With Flag)	DOLBY DIGITAL EX (With no Flag)	DOLBY DIGITAL (5.1/5/4ch)	DOLBY DIGITAL (4/3ch)	DOLBY DIGITAL (2ch)	DVD-Audio (multi ch)	DVD-Audio (2ch)	DSD (multi ch)	DSD (2ch)
STANDARD																	
DTS SURROUND																	
	DTS ES DSCRT6.1	*1	×	×	● ◎	×	×	×	×	×	×	×	×	×	×	×	
	DTS ES MTRX6.1	*1	×	×	×	● ◎	×	×	×	×	×	×	×	×	×	×	
	DTS SURROUND		×	×	○	○	●	×	×	×	×	×	×	×	×	×	
	DTS 96/24		×	×	×	×	●	×	×	×	×	×	×	×	×	×	
	DTS + PLIIx CINEMA	*2	×	×	○	○	○	×	×	×	×	×	×	×	×	×	
	DTS + PLIIx MUSIC	*1	×	×	○	○	○	×	×	×	×	×	×	×	×	×	
	DTS + NEO:6	*1	×	×	×	○	○	×	×	×	×	×	×	×	×	×	
	DTS NEO:6 CINEMA		○	○	×	×	×	×	×	×	×	○	×	○	×	○	
	DTS NEO:6 MUSIC		○	○	×	×	×	×	×	×	×	○	×	○	×	○	
DOLBY SURROUND																	
	DOLBY DIGITAL EX	*1	×	×	×	×	×	○	○	○	○	×	×	×	×	×	
	DOLBY DIGITAL		×	×	×	×	×	○	●	●	●	×	×	×	×	×	
	DOLBY DIGITAL + PLIIx CINEMA	*2	×	×	×	×	×	● ◎	○	○	○	×	×	×	×	×	
	DOLBY DIGITAL + PLIIx MUSIC	*1	×	×	×	×	×	○	○	○	○	×	×	×	×	×	
	DOLBY PRO LOGIC IIx CINEMA		○	○	×	×	×	×	×	×	×	●	×	○	×	○	
	DOLBY PRO LOGIC IIx MUSIC		○	○	×	×	×	×	×	×	×	○	×	○	×	○	
	DOLBY PRO LOGIC IIx GAME		○	○	×	×	×	×	×	×	×	○	×	○	×	○	
	DOLBY PRO LOGIC II CINEMA		○	○	×	×	×	×	×	×	×	○	×	○	×	○	
	DOLBY PRO LOGIC II MUSIC		○	○	×	×	×	×	×	×	×	○	×	○	×	○	
	DOLBY PRO LOGIC II GAME		○	○	×	×	×	×	×	×	×	○	×	○	×	○	
	DOLBY PRO LOGIC		○	○	×	×	×	×	×	×	×	○	×	○	×	○	
	neural		○	○	×	×	×	×	×	×	×	×	×	○	×	×	
MULTI CH IN																	
	MULTI CH IN		×	×	×	×	×	×	×	×	×	×	●	×	●	×	
	MULTI IN + PLIIx CINEMA	*2	×	×	×	×	×	×	×	×	×	×	○	×	○	×	
	MULTI IN + PLIIx MUSIC	*1	×	×	×	×	×	×	×	×	×	×	○	×	○	×	
	MULTI CH IN 7.1		×	×	×	×	×	×	×	×	×	×	● ◎ (7.1)	×	×	×	

**NOTE:**

\*1: This mode is not available when the surround back speaker setup is set to "None".

\*2: This mode is not available when the surround back speaker setup is set to "1spkr" or "None".

● : Mode selectable in initial status

◎ : Mode fixed when "AFDM" is "ON"

○ : Selectable mode

× : Non-selectable mode

Button	Surround mode	Note	Input signals															
			ANALOG	LINEAR PCM	DTS				DOLBY DIGITAL					DVD-AUDIO		Super Audio CD		
					DTS ES DSCRT (With Flag)	DTS ES MTRX (With Flag)	DTS (5.1ch)	DTS 96/24	DOLBY DIGITAL EX (With Flag)	DOLBY DIGITAL EX (With no Flag)	DOLBY DIGITAL (5.1/5/4ch)	DOLBY DIGITAL (4/3ch)	DOLBY DIGITAL (2ch)	DVD-Audio (multi ch)	DVD-Audio (2ch)	DSD (multi ch)	DSD (2ch)	
<b>DIRECT</b>																		
DIRECT			○	○	○	○	○	○	○	○	○	○	○	○	×	○	×	○
DSD DIRECT			×	×	×	×	×	×	×	×	×	×	×	×	×	×	×	○
DSD MULTI DIRECT			×	×	×	×	×	×	×	×	×	×	×	×	×	×	○	×
MULTI CH DIRECT			×	×	×	×	×	×	×	×	×	×	×	○	×	○	×	
M DIRECT + PLIIx CINEMA	*2		×	×	×	×	×	×	×	×	×	×	×	○	×	○	×	
M DIRECT + PLIIx MUSIC	*1		×	×	×	×	×	×	×	×	×	×	×	○	×	○	×	
M DIRECT 7.1			×	×	×	×	×	×	×	×	×	×	×	○	×	×	×	
<b>PURE DIRECT</b>																		
PURE DIRECT			○	○	○	○	○	○	○	○	○	○	○	○	×	○	×	○
DSD PURE DIRECT			×	×	×	×	×	×	×	×	×	×	×	×	×	×	×	○
DSD MULTI PURE			×	×	×	×	×	×	×	×	×	×	×	×	×	×	○	×
MULTI CH PURE DIRECT			×	×	×	×	×	×	×	×	×	×	×	○	×	○	×	
M PURE D + PLIIx CINEMA	*2		×	×	×	×	×	×	×	×	×	×	×	○	×	○	×	
M PURE D + PLIIx MUSIC	*1		×	×	×	×	×	×	×	×	×	×	×	○	×	○	×	
M CH PURE DIRECT 7.1			×	×	×	×	×	×	×	×	×	×	×	○	×	×	×	
<b>DSP SIMULATION</b>																		
7CH STEREO	*3		○	○	○	○	○	○	○	○	○	○	○	○	○	○	○	○
WIDE SCREEN			○	○	○	○	○	○	○	○	○	○	○	○	○	○	○	○
SUPER STADIUM			○	○	○	○	○	○	○	○	○	○	○	○	○	○	○	○
ROCK ARENA			○	○	○	○	○	○	○	○	○	○	○	○	○	○	○	○
JAZZ CLUB			○	○	○	○	○	○	○	○	○	○	○	○	○	○	○	○
CLASSIC CONCERT			○	○	○	○	○	○	○	○	○	○	○	○	○	○	○	○
MONO MOVIE			○	○	○	○	○	○	○	○	○	○	○	○	○	○	○	○
VIDEO GAME			○	○	○	○	○	○	○	○	○	○	○	○	○	○	○	○
MATRIX			○	○	○	○	○	○	○	○	○	○	○	○	○	○	○	○
VIRTUAL			○	○	○	○	○	○	○	○	○	○	○	○	○	○	○	○
<b>STEREO</b>																		
STEREO			●	●	○	○	○	○	○	○	○	○	○	○	○	●	○	●

**NOTE :**  
 \*1: This mode is not available when the surround back speaker setup is set to "None".  
 \*2: This mode is not available when the surround back speaker setup is set to "1spkr" or "None".  
 \*3: If the surround back speaker setup is set to "None", then "5CH STEREO" is displayed.  
 ● : Mode selectable in initial status  
 ○ : Selectable mode  
 × : Non-selectable mode

# Relationship Between Video Signals and Monitor Output

Video convert	Input signals				MONITOR OUT			
	HDMI	COMPONENT	S-VIDEO	VIDEO	HDMI	COMPONENT	S-VIDEO	VIDEO
ON	×	×	×	×	×	×	×	×
	×	×	×	○	VIDEO	VIDEO	VIDEO	VIDEO
	×	×	○	×	S-VIDEO	S-VIDEO	S-VIDEO	S-VIDEO
	×	×	○	○	S-VIDEO	S-VIDEO	S-VIDEO	S-VIDEO
	×	○ (1080p)	×	×	×	COMPONENT	×	×
	×	○ (480p ~ 720p)	×	×	COMPONENT	COMPONENT	×	×
	×	○ (480i / 576i)	×	×	COMPONENT	COMPONENT	COMPONENT	COMPONENT
	×	○ (1080p)	×	○	VIDEO	COMPONENT*1	VIDEO	VIDEO
	×	○ (480p ~ 720p)	×	○	COMPONENT*1	COMPONENT*1	×	VIDEO
	×	○ (480i / 576i)	×	○	COMPONENT*1	COMPONENT*1	COMPONENT	VIDEO
	×	○ (1080p)	○	×	S-VIDEO	COMPONENT*2	S-VIDEO	S-VIDEO
	×	○ (480p ~ 720p)	○	×	COMPONENT*2	COMPONENT*2	S-VIDEO	S-VIDEO
	×	○ (480i / 576i)	○	×	COMPONENT*2	COMPONENT*2	S-VIDEO	S-VIDEO
	×	○ (1080p)	○	○	S-VIDEO	COMPONENT*2	S-VIDEO	S-VIDEO
	×	○ (480p ~ 720p)	○	○	COMPONENT*2	COMPONENT*2	S-VIDEO	S-VIDEO
	×	○ (480i / 576i)	○	○	COMPONENT*2	COMPONENT*2	S-VIDEO	S-VIDEO
	○	×	×	×	HDMI	×	×	×
	○	×	×	○	HDMI*1	VIDEO	VIDEO	VIDEO
	○	×	○	×	HDMI*2	S-VIDEO	S-VIDEO	S-VIDEO
	○	×	○	○	HDMI*2	S-VIDEO	S-VIDEO	S-VIDEO
	○	○ (Other than 480i / 576i)	×	×	HDMI	COMPONENT	×	×
	○	○ (480i / 576i)	×	×	HDMI	COMPONENT	COMPONENT	COMPONENT
	○	○ (1080p)	×	○	HDMI*1	COMPONENT*1	VIDEO	VIDEO
	○	○ (480p ~ 720p)	×	○	HDMI*1	COMPONENT*1	×	VIDEO
	○	○ (480i / 576i)	×	○	HDMI*1	COMPONENT*1	COMPONENT	VIDEO
	○	○ (Other than 480i / 576i)	○	×	HDMI*2	COMPONENT*2	S-VIDEO	S-VIDEO
	○	○ (480i / 576i)	○	×	HDMI*2	COMPONENT*2	S-VIDEO	S-VIDEO
	○	○ (Other than 480i / 576i)	○	○	HDMI*2	COMPONENT*2	S-VIDEO	S-VIDEO
	○	○ (480i / 576i)	○	○	HDMI*2	COMPONENT*2	S-VIDEO	S-VIDEO

○ : Signal input  
 × : No signal  
 480p ~ 720p: 480p / 576p / 1080i / 720p

× : Not output  
 \*1 : On-screen display superimposed on video signal and output.  
 \*2 : On-screen display superimposed on S-Video signal and output.

COMPONENT or HDMI :  
 On-screen display only displayed for **MENU**.



- The main zone video conversion function is compatible with the following format: NTSC, PAL, SECAM, NTSC4.43, PAL-N, PAL-M and PAL-60.
- When SECAM signals of video input are up-converted, the signals are output in PAL format from the S-Video connector.
- When the input signal is a component 1080i or 720p signal, the signal upconverted to HDMI is output with that resolution or 1080p.
- When the input signal is a video, S-Video or component 480i, 480p, 576i or 576p signals, the signal up-converted to HDMI is output according to the setting made at "Resolution" under "HDMI Setup" – "HDMI Video Setup" (page 28).
- Signals up-converted to HDMI are output to the HDMI monitor with the resolution at which they are input.

Video convert	S-VIDEO MONITOR OUT	Input signals				MONITOR OUT			
		HDMI	COMPONENT	S-VIDEO	VIDEO	HDMI	COMPONENT	S-VIDEO	VIDEO
OFF	—	×	×	×	×	×	×	×	×
	—	×	×	×	○	×	×	×	VIDEO
	—	×	×	○	×	×	×	S-VIDEO	×
	Used	×	×	○	○	×	×	S-VIDEO	VIDEO*2
	Not used	×	×	○	○	×	×	—	VIDEO
	—	×	○	×	×	×	COMPONENT	×	×
	—	×	○	×	○	×	COMPONENT*1	×	VIDEO
	—	×	○	○	×	×	COMPONENT*2	S-VIDEO	×
	Used	×	○	○	○	×	COMPONENT*2	S-VIDEO	VIDEO*2
	Not used	×	○	○	○	×	COMPONENT*1	—	VIDEO
	—	○	×	×	×	HDMI	×	×	×
	—	○	×	×	○	HDMI	×	×	VIDEO
	—	○	×	○	×	HDMI	×	S-VIDEO	×
	Used	○	×	○	○	HDMI	×	S-VIDEO	VIDEO*2
	Not used	○	×	○	○	HDMI	×	—	VIDEO
	—	○	○	×	×	HDMI	COMPONENT	×	×
	—	○	○	×	○	HDMI	COMPONENT*1	×	VIDEO
	—	○	○	○	×	HDMI	COMPONENT*2	S-VIDEO	×
	Used	○	○	○	○	HDMI	COMPONENT*2	S-VIDEO	VIDEO*2
	Not used	○	○	○	○	HDMI	COMPONENT*1	—	VIDEO

○ : Signal input  
 × : No signal

× : Not output  
 \*1 : On-screen display superimposed on video signal and output.  
 \*2 : On-screen display superimposed on S-Video signal and output.

COMPONENT or HDMI :  
 On-screen display only displayed for **MENU**.

**☐ ZONE2 monitor out**

Input		Monitor out
S-VIDEO	VIDEO	VIDEO
×	×	×
×	○	○ (VIDEO)
○	×	○ (S-VIDEO)
○	○	○ (S-VIDEO)

○ : Signal present  
 × : No signal

○ : Output present  
 × : No output

# Troubleshooting

If a problem should arise, first check the following:

1. Are the connections correct?
2. Is the set being operated as described in the owner's manual?
3. Are the other components operating properly?

If this unit does not operate properly, check the items listed in the table below. Should the problem persist, there may be a malfunction.

In this case, disconnect the power immediately and contact your store of purchase.

## [General]

Symptom	Cause	Countermeasure	Page
Power does not turn on, or turns off directly after it was turned on.	<ul style="list-style-type: none"> <li>• Connection of the power cord is faulty.</li> </ul>	<ul style="list-style-type: none"> <li>• Check that the power plugs are securely inserted into the AVR-988's AC inlet and the wall power outlet.</li> </ul>	20
No sound is produced from speakers.	<ul style="list-style-type: none"> <li>• Connection with the input devices or connection of the speaker cables is faulty.</li> <li>• Device you want to play and set input source do not match.</li> <li>• Master volume is turned too low.</li> <li>• Mute mode is set.</li> <li>• Headphones are connected.</li> <li>• No digital signals are being input.</li> </ul>	<ul style="list-style-type: none"> <li>• Check the connections.</li> </ul>	9
		<ul style="list-style-type: none"> <li>• Select an appropriate input source.</li> </ul>	43
		<ul style="list-style-type: none"> <li>• Adjust the master volume to an appropriate level.</li> </ul>	43
		<ul style="list-style-type: none"> <li>• Cancel the mute mode.</li> <li>• Disconnect the headphones.</li> </ul>	43
		<ul style="list-style-type: none"> <li>• Select an input source for which the digital input setting has been made.</li> </ul>	35
<ul style="list-style-type: none"> <li>• The connectors to which the digital inputs are assigned and the settable input modes do not match.</li> </ul>	<ul style="list-style-type: none"> <li>• Set the input mode.</li> </ul>	34	
Display is off.	<ul style="list-style-type: none"> <li>• The "Dimmer" setting is set to "OFF".</li> <li>• The PURE DIRECT mode is set.</li> </ul>	<ul style="list-style-type: none"> <li>• Set to something other than "OFF".</li> </ul>	32
		<ul style="list-style-type: none"> <li>• Set a surround mode other than the PURE DIRECT mode.</li> </ul>	37
"DOLBY DIGITAL" indicator does not appear on display.	<ul style="list-style-type: none"> <li>• DVD player's digital audio output setting is not proper.</li> </ul>	<ul style="list-style-type: none"> <li>• Check the DVD player's audio output setting. For details, read the DVD player's operating instructions.</li> </ul>	-

Symptom	Cause	Countermeasure	Page
Power turns off suddenly and power indicator flashes red.	<ul style="list-style-type: none"> <li>• Protection circuit activated due to rise of internal temperature.</li> </ul>	<ul style="list-style-type: none"> <li>• Turn off the power, wait for the set to fully cool down, then turn the power back on.</li> </ul>	10
		<ul style="list-style-type: none"> <li>• Place the set in a well-ventilated place.</li> </ul>	10
	<ul style="list-style-type: none"> <li>• Core wires of two speakers are touching each other or a core wire is sticking out of the terminal and touching the set's rear panel, activating the protection circuit.</li> <li>• Speakers with an impedance other than specified are being used.</li> <li>• Set is damaged.</li> </ul>	<ul style="list-style-type: none"> <li>• First unplug the power cord, then twist the core wires tightly or terminate the speaker cables, then reconnect.</li> </ul>	10
		<ul style="list-style-type: none"> <li>• Use speakers with the specified impedance.</li> <li>• Turn off the power and contact a DENON service center.</li> </ul>	-

## [Remote Control Unit]

Symptom	Cause	Countermeasure	Page
Set does not work properly when remote control unit operated.	<ul style="list-style-type: none"> <li>• Batteries are worn.</li> <li>• You are operating outside of the specified range.</li> </ul>	<ul style="list-style-type: none"> <li>• Replace with new batteries.</li> </ul>	3
		<ul style="list-style-type: none"> <li>• Operate within the specified range.</li> </ul>	3
	<ul style="list-style-type: none"> <li>• Obstacle between main unit and remote control unit.</li> <li>• The batteries are not inserted in the proper direction, as indicated by the polarity marks in the battery compartment.</li> </ul>	<ul style="list-style-type: none"> <li>• Remove the obstacle.</li> </ul>	3
		<ul style="list-style-type: none"> <li>• Insert the batteries in the proper direction, following the polarity marks in the battery compartment.</li> </ul>	3
	<ul style="list-style-type: none"> <li>• The set's remote control sensor is exposed to strong light (direct sunlight, inverter type fluorescent bulb light, etc.).</li> <li>• The remote ID of the main unit and remote control unit do not match.</li> </ul>	<ul style="list-style-type: none"> <li>• Move the set to a place in which the remote control sensor will not be exposed to strong light.</li> </ul>	3
		<ul style="list-style-type: none"> <li>• Set "Remote ID" for the main unit to "1".</li> </ul>	32

**[Audio]**

Symptom	Cause	Countermeasure	Page
No sound is produced from center speaker.	• You are playing a monaural source (TV, AM radio broadcast, etc.) in the STANDARD mode.	• The mode is set to something other than "STANDARD".	36
No sound is produced from surround speakers.	• The surround mode is set to "STEREO", "DIRECT" or "PURE DIRECT".	• Set to a surround playback mode.	37
No sound is produced from surround back speaker.	• The surround back speaker's power amplifier is assigned to a different channel. • Surround back speaker setting is set to "None". • Surround mode not set to a mode for 6.1- or 7.1-channel playback.	• Check the setting and change it as necessary.	31
		• Set to something other than "None".	26
		• Select a surround playback mode.	37
No sound is produced from subwoofer.	• Subwoofer's power not turned on. • The "Subwoofer" setting at "Speaker configuration" is set to "No". • The subwoofer is not properly connected. • The subwoofer's volume is turned off.	• Turn on the subwoofer's power.	-
		• Set to "Yes".	26
No test tones are produced when remote control unit's TEST button is pressed.	• Surround mode not set to "STANDARD".	• Check the connections.	9
		• Adjust the subwoofer's volume to an appropriate level.	50
DTS sound is not output.	• DVD player's audio output setting is not set to bitstream. • DVD player is not compatible with DTS sound playback. • The AVR-988's "Decode Mode" setting is set to "PCM".	• Set to the STANDARD mode.	36
		• Set the DVD player. For details, refer to the DVD player's operating instructions. • Use a DTS-compatible player.	-
HDMI audio signals are not output from speakers.	• The "Manual Setup" - "HDMI Setup" - "HDMI Audio Setup" - "HDMI Audio Out" setting is set to "TV".	• Set to the "Auto" or "DTS" mode.	34
		• Set to "AMP".	27

Symptom	Cause	Countermeasure	Page
No sound is output from the monitor connected with HDMI connections.	• The "Manual Setup" - "HDMI Setup" - "HDMI Audio Setup" - "HDMI Audio Out" setting is set to "AMP".	• Set to "TV".	27

**[Video]**

Symptom	Cause	Countermeasure	Page
No picture appears.	• The connections between the AVR-988 and monitor are faulty. • The monitor's input setting is wrong. • PURE DIRECT mode is set. • The player is connected using the component input connectors, the monitor is connected using the video (yellow) or S-Video output connectors.	• Check the connections.	11 ~ 20
		• Set properly.	-
		• Cancel the PURE DIRECT mode. • High definition (1080i/720p) and progressive (480p/576p) video signals are not down-converted. Set the player to interlace (480i/576i) signals.	37 -
No picture appears with HDMI connections.	• The connections to the HDMI connectors are faulty. • HDMI input setting is improper. • The monitor is not compatible with copyright protection (HDCP). • The HDMI format of the player and monitor do not match.	• Check the connections.	11
		• Check the HDMI input setting.	34
		• Connect a monitor that is compatible with copyright protection (HDCP). • Match the HDMI format of the player and monitor.	11
Picture cannot be recorded.	• Input source does not match recorder's video connection connector (video or S-Video).	• The video conversion function does not work for the REC OUT connectors. Match the input source and recorder connections.	15
DVDs cannot be copied on a VCR.	-	• This is not a malfunction. Most movie software includes copy prevention signals and cannot be copied.	-



**[iPod]**

Symptom	Cause	Countermeasure	Page
iPod cannot be played.	<ul style="list-style-type: none"> <li>• The input source assigned to "iPod dock" is not selected.</li> <li>• Cable is not properly connected.</li> <li>• Control Dock for iPod's AC adapter is not connected to power outlet.</li> </ul>	<ul style="list-style-type: none"> <li>• Switch to the input source assigned at "iPod dock".</li> </ul>	35
		<ul style="list-style-type: none"> <li>• Reconnect.</li> <li>• Plug the Control Dock for iPod's AC adapter into a power outlet.</li> </ul>	14 –

**[XM Satellite Radio]**

Symptom	Cause	Countermeasure	Page
"CHECK ANTENNA" is displayed in the XM mode.	<ul style="list-style-type: none"> <li>• AVR-988's XM connector and the XM Mini-Tuner and Home Dock is not properly connected.</li> </ul>	<ul style="list-style-type: none"> <li>• Check that the connections are correct.</li> </ul>	18
"NO SIGNAL" is displayed in the XM mode.	<ul style="list-style-type: none"> <li>• The signal cannot be received.</li> </ul>	<ul style="list-style-type: none"> <li>• Reposition your XM Mini-Tuner and Home Dock antenna.</li> </ul>	46
"OFF AIR" is displayed in the XM mode.	<ul style="list-style-type: none"> <li>• The selected channel is not currently broadcasting.</li> </ul>	<ul style="list-style-type: none"> <li>• Select another channel.</li> </ul>	45, 46
Receiving only XM channels 0 and 1.	<ul style="list-style-type: none"> <li>• The XM Tuner is not activated.</li> </ul>	<ul style="list-style-type: none"> <li>• Contact XM Radio.</li> </ul>	45

# Specifications

## Audio section

### Power amplifier

#### Rated output:

Front (A, B):  
 110 W + 110 W (8 Ω/ohms, 20 Hz ~ 20 kHz with 0.05 % T.H.D.)  
 140 W + 140 W (6 Ω/ohms, 1 kHz with 0.7 % T.H.D.)

#### Center:

110 W (8 Ω/ohms, 20 Hz ~ 20 kHz with 0.05 % T.H.D.)  
 140 W (6 Ω/ohms, 1 kHz with 0.7 % T.H.D.)

#### Surround:

110 W + 110 W (8 Ω/ohms, 20 Hz ~ 20 kHz with 0.05 % T.H.D.)  
 140 W + 140 W (6 Ω/ohms, 1 kHz with 0.7 % T.H.D.)

#### Surround Back:

110 W + 110 W (8 Ω/ohms, 20 Hz ~ 20 kHz with 0.05 % T.H.D.)  
 140 W + 140 W (6 Ω/ohms, 1 kHz with 0.7 % T.H.D.)

#### Dynamic power:

120 W x 2ch (8 Ω/ohms)  
 170 W x 2ch (4 Ω/ohms)

#### Output terminals:

Front:	A or B	6 ~ 16 Ω/ohms
	A + B	8 ~ 16 Ω/ohms
Center, Surround, Surr. Back:		6 ~ 16 Ω/ohms

### Analog

**Input sensitivity / Input impedance:** 200 mV / 47 kΩ/kohms

**Frequency response:** 10 Hz ~ 100 kHz — +1, -3 dB (DIRECT mode)

**S/N:** 102 dB (DIRECT mode)

**Distortion:** 0.005 % (20 Hz ~ 20 kHz) (DIRECT mode)

**Rated output:** 1.2 V

### Digital

**D/A output:** Rated output — 2 V (at 0 dB playback)

Total harmonic distortion — 0.008 % (1 kHz, at 0 dB)

S/N ratio — 102 dB

Dynamic range — 96 dB

Format — Digital audio interface

#### Digital input:

### Phono equalizer (PHONO input — REC OUT)

**Input sensitivity:** 2.5 mV

**RIAA deviation:** ±1 dB (20 Hz to 20 kHz)

**S/N:** 74 dB (A weighting, with 5 mV input)

**Rated output:** 150 mV

**Distortion factor:** 0.03 % (1 kHz, 3 V)

## Video section

### Standard video terminals

**Input / output level and impedance:** 1 Vp-p, 75 Ω/ohms

**Frequency response:** 5 Hz ~ 10 MHz — +0, -3 dB

### S-Video terminals

**Input / output level and impedance:** Y (brightness) signal — 1 Vp-p, 75 Ω/ohms

C (color) signal — 0.286 Vp-p, 75 Ω/ohms

**Frequency response:** 5 Hz ~ 10 MHz — +0, -3 dB

### Color component video terminal

**Input / output level and impedance:** Y (brightness) signal — 1 Vp-p, 75 Ω/ohms

P<sub>B</sub> / C<sub>B</sub> signal — 0.7 Vp-p, 75 Ω/ohms

P<sub>R</sub> / C<sub>R</sub> signal — 0.7 Vp-p, 75 Ω/ohms

**Frequency response:** 5 Hz ~ 100 MHz — +0, -3 dB (when video convert set to "OFF")

## Tuner section

### [FM]

### [AM]

(note: μV at 75 Ω/ohms, 0 dBf = 1 × 10<sup>-15</sup> W)

**Receiving Range:** 87.5 MHz ~ 107.9 MHz

520 kHz ~ 1710 kHz

**Usable Sensitivity:** 1.0 μV (11.2 dBf)

18 μV

**50 dB Quieting Sensitivity:** MONO 1.6 μV (15.3 dBf)

STEREO 23 μV (38.5 dBf)

**S/N (IHF-A):** MONO 77 dB

STEREO 72 dB

**Total harmonic Distortion (at 1 kHz):** MONO 0.15 %

STEREO 0.3 %

## General

**Power supply:** AC 120 V, 60 Hz

**Power consumption:** 6.0 A

0.3 W (Standby)

**Maximum external dimensions:** 434 (W) x 171 (H) x 427 (D) mm (17-3/32" x 6-47/64" x 16-13/16")

**Weight:** 13.2 kg (29 lbs 1.6 oz)

## Remote control unit (RC-1069)

**Batteries:** R6P/AA Type (two batteries)

**Maximum external dimensions:** 52 (W) x 243 (H) x 21 (D) mm (2-3/64" x 9-9/16" x 53/64")

**Weight:** 184 g (Approx 6.5 oz) (including batteries)

\* For purposes of improvement, specifications and design are subject to change without notice.

## List of preset codes / Liste de codes pré-régulés

### DVD Player

<b>A</b>	Aiwa	009
<b>D</b>	Denon	014, [111]*
<b>H</b>	Hitachi	010
<b>J</b>	JVC	006, 011
<b>K</b>	Konka	012, 013
<b>M</b>	Magnavox	005
	Mitsubishi	004
<b>P</b>	Panasonic	014
	Philips	005, 015, 016, 017
	Pioneer	003, 008
<b>S</b>	Sanyo	018
	Sony	002, 019, 020
<b>T</b>	Toshiba	001, 021, 022
<b>Z</b>	Zenith	023

### VDP

<b>D</b>	Denon	028, 029, 112
<b>M</b>	Magnavox	026
	Mitsubishi	028
<b>P</b>	Panasonic	029, 030
	Philips	026
	Pioneer	028, 031
<b>R</b>	RCA	032
<b>S</b>	Sony	033, 034, 035, 036

### VCR

<b>A</b>	Admiral	081
	Aiko	095
	Aiwa	009
	Akai	026, 027, 070, 072, 082, 083, 084
	Alba	055
	Amstrad	009
	ASA	042
	Asha	087
	Audio Dynamic	005, 085
	Audiovox	088
	Beaumarck	087
	Broksonic	086, 093
<b>C</b>	Calix	088
	Candle	006, 087, 088, 089, 090
	Canon	049, 057
	Capehart	025, 055, 056, 071
	Carver	015
	CCE	095
	Citizen	006, 007, 087, 088, 089, 090, 095
	Craig	007, 087, 088, 091, 115

	Curtis Mathes	006, 049, 073, 080, 087, 090, 092
	Cybernex	087
<b>D</b>	Daewoo	025, 055, 059, 074, 089, 093, 095, 096
	Daytron	025, 055
	DBX	005, 085
	Dumont	053
	Dynatech	009
<b>E</b>	Electrohome	001, 088, 097
	Electroponic	088
	Emerson	001, 009, 017, 027, 086, 088, 089, 092, 093, 097, 100, 101, 102, 103, 104, 117
<b>F</b>	Fisher	009, 028, 031, 053, 054, 091, 099, 115
<b>G</b>	GE	007, 011, 049, 050, 051, 052, 073, 080, 087
	Go Video	047, 048
	Goldstar	000, 006, 012, 062, 088
	Gradiente	094
	Grundig	042
<b>H</b>	Harley Davidson	094
	Harman Kardon	040, 062
	Hi-Q	091
	Hitachi	009, 013, 023, 026, 058, [108]*, 109, 110, 111
<b>J</b>	JC Penny	004, 005, 007, 023, 028, 049, 062, 085, 087, 088
	Jensen	013, 026
	JVC	004, 005, 006, 026, 029, 043, 044, 045, 046, 085
<b>K</b>	Kenwood	004, 005, 006, 026, 029, 033, 045, 085, 090
	Kodak	088
<b>L</b>	Lloyd	009, 094
	LXI	088
<b>M</b>	Magnavox	015, 016, 042, 049, 063, 106
	Magnin	087
	Marantz	004, 005, 006, 015, 042, 049, 085, 090
	Marta	088
	MEI	049
	Memorex	009, 033, 049, 053, 060, 081, 087, 088, 091, 094, 115
	Metz	123, 124, 125, 126, 127, 128
	MGA	001, 017, 027, 041, 097
	MGN Technology	087
	Midland	011
	Minolta	013, 023
	Mitsubishi	001, 003, 008, 013, 014, 017, 027, 029, 039, 040, 041, 045, 097
	Motorola	081
	Montgomery Ward	001, 002, 007, 009, 049, 063, 081, 115, 117
	MTC	009, 087, 094

	Multitech	007, 009, 011, 087, 090, 094
<b>N</b>	NAD	038
	NEC	004, 005, 006, 018, 026, 029, 045, 061, 062, 085
	Nikko	088
	Noblex	087
<b>O</b>	Optimus	081, 088
	Optonica	021
<b>P</b>	Panasonic	024, 049, 064, 066, 067, 068, 069, 107
	Perdio	009
	Pentax	009, 013, 023, 058, 090
	Philco	015, 016, 049
	Philips	015, 021, 042, 049, 105
	Pilot	088
	Pioneer	005, 013, 029, 036, 037, 038, 045, 085
	Portland	025, 055, 090
	Proscan	063, 080
	Pulsar	060
<b>Q</b>	Quartz	033
	Quasar	034, 035, 049
<b>R</b>	Radio Shack	001, 002, 021, 081, 087, 088, 091, 094, 097, 098, 115
	Radix	088
	Randex	088
	RCA	007, 013, 019, 023, 058, 063, 064, 065, 073, 080, 082, 087, 089, 021, 031, 033, 049, 053, 081, 087, 088, 091, 094, 097, 098
	Realistic	055
<b>S</b>	Salora	033, 041
	Samsung	007, 011, 051, 059, 070, 083, 087, 089, 113
	Sanky	081
	Sansui	005, 026, 029, 045, 061, 085, 114
	Sanyo	032, 033, 053, 087, 091, 115, 116
	SBR	042
	Scott	017, 020, 086, 089, 093, 117
	Sears	013, 023, 028, 031, 033, 053, 054, 088, 091, 098, 099, 115
	Sentra	055
	Sharp	001, 002, 021, 097
	Shogun	087
	Sony	075, 076, 077, 078, 079, 121, 122
	STS	023
	Sylvania	009, 015, 016, 017, 041, 049, 094
	Symphonic	009, 094
<b>T</b>	Tandy	009
	Tashiko	009, 088
	Tatung	004, 026, 030

	Teac	004, 009, 026, 094
	Technics	024, 049
	TMK	087, 092
	Toshiba	013, 017, 020, 041, 059, 089, 098, 099, 117
	Totevision	007, 087, 088
<b>U</b>	Unirech	087
<b>V</b>	Vectror Research	005, 062, 085, 089, 090
	Victor	005, 045, 046, 085
	Video Concepts	005, 027, 085, 089, 090
	Videosonic	007, 087
<b>W</b>	Wards	013, 021, 023, 087, 088, 089, 091, 094, 097, 118, 119, 120
<b>X</b>	XR-1000	094
<b>Y</b>	Yamaha	004, 005, 006, 026, 062, 085
<b>Z</b>	Zenith	060, 078, 079

### Television

<b>A</b>	Admiral	045, 121
	Adventura	122
	Aiko	054
	Akai	016, 027, 046
	Alleron	062
	A-Mark	007
	Amtron	061
	Anam	006, 007, 036
	Anam National	061, 147
	AOC	003, 007, 033, 038, 039, 047, 048, 049, 133
	Archer	007
	Audiovox	007, 061
<b>B</b>	Bauer	155
	Belcor	047
	Bell & Howell	045, 118
	Bradford	061
	Brockwood	003, 047
<b>C</b>	Candle	003, 030, 031, 032, 038, 047, 049, 050, 122
	Capehart	003
	Celebrity	046
	Circuit City	003
	Citizen	029, 030, 031, 032, 034, 038, 047, 049, 050, 054, 061, 095, 122, 123
	Concerto	031, 047, 049
	Colortyme	003, 047, 049, 135
	Contec	013, 051, 052, 061
	Cony	051, 052, 061
	Craig	004, 061
	Crown	029
	Curtis Mathes	029, 034, 038, 044, 047, 049, 053, 095, 118

<b>D</b>	Daewoo	027, 029, 039, 048, 049, 054, 055, 106, 107, 137
	Daytron	003, 049
	Dimensia	044
	Dixi	007, 015, 027
<b>E</b>	Electroband	046
	Electrohome	029, 056, 057, 058, 147
	Elta	027
	Emerson	029, 051, 059, 060, 061, 062, 118, 123, 124, 139, 148
	Envision	038
	Etron	027
<b>F</b>	Fisher	014, 021, 063, 064, 065, 118
	Formenti	155
	Fortress	012
	Fujitsu	004, 062
	Funai	004, 062
	Futuretech	004
<b>G</b>	GE	020, 036, 037, 040, 044, 058, 066, 088, 119, 120, 125, 147
	Goldstar	000, 015, 029, 031, 039, 048, 051, 056, 057, 067, 068, 069, 116
	Grundy	062
<b>H</b>	Hitachi	029, 031, 051, 052, 070, 111, 112, 113, 124, [134]*
	Hitachi Pay TV	151
<b>I</b>	Infinity	017, 071
<b>J</b>	Janeil	122
	JBL	017, 071
	JC Penny	020, 034, 039, 040, 041, 044, 048, 050, 058, 066, 069, 076, 088, 090, 095, 125, 136, 159
	JCB	046
	JVC	019, 051, 052, 072, 073, 091, 117, 126
<b>K</b>	Kawasho	018, 046
	Kenwood	038, 056, 057
	Kloss	010, 032
	Kloss Novabeam	005, 122, 127, 131
	KTV	074, 123
<b>L</b>	Loewe	071
	logik	144
	Luxman	031
	LXI	008, 014, 017, 024, 040, 044, 063, 071, 075, 076, 077, 118, 125
<b>M</b>	Magnavox	005, 010, 017, 030, 033, 038, 050, 056, 071, 078, 079, 085, 089, 108, 109, 110, 127, 131, 132, 145
	Marantz	015, 017, 071, 080
	Matsui	027
	Memorex	014, 027, 045, 083, 118, 144
	Metz	160, 161, 162, 163

MGA	001, 039, 048, 056, 057, 058, 065, 081, 083
Midland	125
Minutz	066
Mitsubishi	001, 016, 039, 048, 056, 057, 058, 065, 081, 082, 083, 105
Montgomery Ward	011, 020, 144, 145, 146
Motorola	121, 147
MTC	031, 034, 039, 048, 095
<b>N</b>	
NAD	008, 075, 076, 128
National	002, 036, 061, 147
National Quenties	002
NEC	031, 038, 039, 048, 057, 084, 086, 135, 147
Nikko	054
NTC	054
<b>O</b>	
Optimus	128
Optonica	011, 012, 093, 121
Orion	004, 139
<b>P</b>	
Panasonic	002, 009, 017, 036, 037, 071, 141, 143, 147
Philco	005, 010, 030, 050, 051, 056, 079, 085, 127, 131, 132, 145, 147
Philips	005, 015, 017, 050, 051, 056, 078, 087, 088, 089, 131, 132, 147
Pioneer	124, 128, 142
Portland	054
Price Club	095
Proscan	040, 044, 125
Proton	035, 051, 092, 129
Pulsar	042
<b>Q</b>	
Quasar	036, 037, 074, 141
<b>R</b>	
Radio Shack	011, 044, 063, 093, 118
RCA	040, 044, 125, 130, 137, 151, 152
Realistic	014, 063, 093, 118
<b>S</b>	
Saisho	027
Samsung	003, 015, 034, 053, 055, 057, 094, 095, 136, 153
Sansui	139
Sanyo	013, 014, 021, 022, 063, 064, 081, 096
SBR	015
Schneider	015
Scott	062
Sears	008, 014, 021, 022, 023, 024, 025, 040, 052, 057, 062, 063, 064, 065, 073, 075, 076, 097, 098, 125, 159
Sharp	011, 012, 013, 026, 093, 099, 100, 104, 121
Siemens	013
Signature	045, 144
Simpson	050
Sony	043, 046, 138, 146, 150
Soundesign	030, 050, 062
Spectricon	007, 033

Squareview	004
Supre-Macy	032, 122
Supreme	046
Sylvania	005, 010, 017, 030, 078, 079, 085, 089, 101, 127, 131, 132, 145, 155
Symphonic	004, 148
<b>T</b>	
Tandy	012, 121
Tatung	036, 124
Technics	037
Teknika	001, 030, 032, 034, 052, 054, 078, 083, 095, 144, 156, 157
Tera	035, 129
THOMSON	165, 166
Toshiba	008, 014, 034, 063, 075, 076, 095, 097, 136, 158, 159
<b>U</b>	
Universal	020, 066, 088
<b>V</b>	
Victor	019, 073, 126
Video Concepts	016
Viking	032, 122
<b>W</b>	
Wards	005, 045, 066, 078, 085, 088, 089, 093, 102, 103, 131, 132, 148
<b>Z</b>	
Zenith	042, 114, 115, 140, 144, 149
Zonda	007

### Cable

<b>A</b>	ABC	006, [007]*, 008, 009
	Archer	010, 011
<b>C</b>	Century	011
	Citizen	011
	Colour Voice	012, 013
	Comtronic	014
<b>E</b>	Eastern	015
<b>G</b>	Garrard	011
	Gemini	030, 033, 034
	General Instrument	030, 031, 032
<b>H</b>	Hytex	006
<b>J</b>	Jasco	011
	Jerrold	009, 016, 017, 026, 032
<b>M</b>	Magnavox	018
	Movie Time	019
<b>N</b>	NSC	019
<b>O</b>	Oak	000, 006, 020
<b>P</b>	Panasonic	001, 005
	Philips	011, 012, 013, 018, 021
	Pioneer	002, 003, 022
<b>R</b>	RCA	029
	Regency	015
<b>S</b>	Samsung	014, 023
	Scientific Atlanta	004, 024, 025
	Signal	014
	SL Marx	014
	Starcom	009

Stargate	014
<b>T</b>	
Televue	014
Tocom	007, 016
TV86	019
<b>U</b>	
Unika	011
United Artists	006
Universal	010, 011
<b>V</b>	
Viewstar	018, 019
<b>Z</b>	
Zenith	027, 028

### Satellite Receiver

<b>A</b>	Alphastar	054
<b>C</b>	Chaparrali	035, 036
<b>D</b>	Dishnet	053
	Drake	037, 038
<b>E</b>	Echostar Dish	062, 066
<b>G</b>	GE	048, 055, 056
	General Instruments	039, 040, 041
	Grundig	070, 071, 072, 073
<b>H</b>	Hitachi	058, 059
	Hughes Networkr	063, 064, 065, 069
<b>J</b>	JVC	057
<b>K</b>	Kathrein	074, 075, 076, 083
<b>M</b>	Magnavoxl	060
<b>N</b>	Nokia	070, 080, 084, 085, 086
<b>P</b>	Philips	060
	Primestar	051
	Proscan	048, 055, 056
<b>R</b>	RCA	048, 055, 056, 068
	Realistic	042
<b>S</b>	Sierra I	036
	Sierra II	036
	Sierra III	036
	Sony	049, 067
	STS1	043
	STS2	044
	STS3	045
	SRS4	046
<b>T</b>	Technisat	077, 078, 079, 081, 082
	Toshiba	047, 050
	Uniden	061

### CD Player

<b>A</b>	Aiwa	001, 035, 043
<b>B</b>	Burmster	002
<b>C</b>	Carvery	003, 035
<b>D</b>	Denon	[111]*, 044
<b>E</b>	Emerson	004, 005, 006, 007
<b>F</b>	Fisher	003, 008, 009, 010
<b>J</b>	JVC	018, 019

Kenwood	011, 012, 013, 014, 017
<b>M</b>	
Magnavox	006, 015, 035
Marantz	016, 028, 035
MCS	016, 024
<b>O</b>	
Ornkyo	025, 027
Optimus	017, 020, 021, 022, 023
<b>P</b>	
Philips	014, 032, 033, 035
Pioneer	006, 022, 030
<b>S</b>	
Sears	006
Sony	023, 031
<b>T</b>	
Teac	002, 009, 028
Technics	016, 029, 036
<b>W</b>	
Wards	035, 037
<b>Y</b>	
Yamaha	038, 039, 040, 041
<b>Z</b>	
Zenith	042

### CD Recorder

<b>D</b>	Denon	[151]*, 112
<b>P</b>	philips	112

### MD Recorder

<b>A</b>	Kenwood	053, 054
<b>B</b>	Onkyo	057
<b>C</b>	Sharp	055
<b>D</b>	Denon	113
<b>E</b>	Sony	056

### Tape Deck

<b>A</b>	Aiwa	001, 002
<b>C</b>	Carver	002
<b>D</b>	Denon	111
<b>H</b>	Harman/Kardon	002, 003
<b>J</b>	JVC	004, 005
<b>K</b>	Kenwood	006
<b>M</b>	Magnavox	002
	Marantz	002
<b>O</b>	Onkyo	016,018
	Optimus	007,008
<b>P</b>	Panasonic	012
	Philips	002
	pioneer	007, 008, 009
<b>S</b>	Sony	013, 014, 015
<b>T</b>	Technics	012
<b>V</b>	Victor	004
<b>W</b>	Wards	007
<b>Y</b>	Yamaha	010, 011

DVD preset codes / Codes prérégls DVD		
DENON Model No. / Modèle numéro	111 (default / défaut)	014
	DVD-555	DVD-2800II
DVD-755	DVD-2900	DVM-2815
DVD-900	DVD-2910	DVM-4800
DVD-910	DVD-2930CI	DVD-800
DVD-955	DVD-3800	DVD-1600
DVD-1000	DVD-3910	DVD-2000
DVD-1200	DVD-3930CI	DVD-2500
DVD-1500	DVD-5900	DVD-3000
DVD-1710	DVD-5910	DVD-3300
DVD-1910	DVD-9000	
DVD-1930CI	DVM-715	
DVD-2200	DVM-1800	
DVD-2800	DVM-1805	

[ ]\* : Preset codes set upon shipment from the factory.

: Les codes prérégls diffèrent en fonction des livraisons de l'usine.







**DENON**

TOKYO, JAPAN  
[www.denon.com](http://www.denon.com)

Denon Brand Company, D&M Holdings Inc.  
Printed in Japan 00D 511 4667 101



## Free Manuals Download Website

<http://myh66.com>

<http://usermanuals.us>

<http://www.somanuals.com>

<http://www.4manuals.cc>

<http://www.manual-lib.com>

<http://www.404manual.com>

<http://www.luxmanual.com>

<http://aubethermostatmanual.com>

Golf course search by state

<http://golfingnear.com>

Email search by domain

<http://emailbydomain.com>

Auto manuals search

<http://auto.somanuals.com>

TV manuals search

<http://tv.somanuals.com>