

DESA[™]

HEATING PRODUCTS

MODEL CGESBM ELECTRIC STOVE WITH MANUAL CONTROL

SAFETY INFORMATION AND OPERATION MANUAL

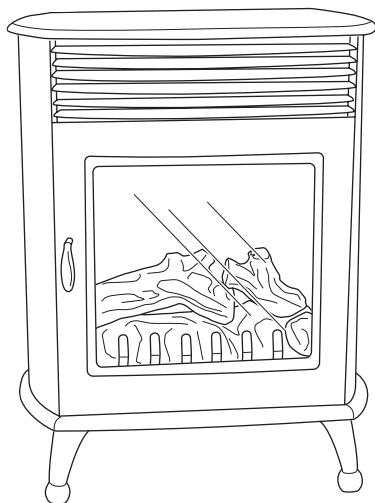

Read these instructions completely before operating electric stove. Failure to follow them could cause a heater malfunction resulting in serious injury and/or property damage.

Save this manual for future reference.

For more information, visit www.desatech.com.

Download from www.Somanuals.com. All Manuals Search And Download.

TABLE OF CONTENTS

Safety Information	2	Cleaning and Maintenance.....	4
Listing Approvals	3	Technical Service	7
Unpacking and Testing the Unit.....	3	Replacement Parts	7
Product Dimensions & Specifications.....	3	Troubleshooting.....	7
Grounding Instructions	4	Warranty Information	Back Page
Operating Instructions	4		

SAFETY INFORMATION

⚠ WARNING: Improper installation, adjustment, alteration, service or maintenance can cause injury or property damage. Refer to this manual. For assistance or additional information, consult a qualified installer.

⚠ WARNING: Risk of fire - keep combustible material away from the front of the heater. Keep electrical codes, drapery and other furnishings at least 3 feet from the front and sides of electric stove.

⚠ WARNING: Servicing should be done only while the heater is disconnected from the power supply circuit.

⚠ CAUTION: For lower lamps (ember bed) and flame generation lamps, replace only with lamp type GX6.35 rated 120V, 35W max. For upper lamps (top contrasting light) replace only with lamp type GX6.35, rated 120V , 20W max.

Your electric stove is classified as an electric heater. As with any electrical appliance and particularly with electric heaters, basic precautions must be followed in order to reduce the risk of fire, burns, electrical shocks and/or other serious injuries or death.

1. Read all instructions before using this heater.
2. The unit can become hot when in use. To avoid accidental burns, do not allow bare skin to come into contact with the hot surfaces of the unit. Keep children and pets away from unit when in use.

3. Keep combustible materials, such as furniture, pillows, bedding, papers, clothes and curtains at least 3 feet from heater. Do not use this unit in areas where gasoline, paint or other flammable liquids or their associated vapors may be present.
4. Do not use this unit for drying wet clothes.
5. Do not operate unit if it is damaged or has malfunctioned. If you suspect the unit is damaged, return it to an authorized service facility for examination, electrical or mechanical adjustment or repair.
6. Do not use this unit outdoors.
7. Do not use or install this unit in areas prone to dampness or where it may come into contact with water. This heater is not intended for use in bathrooms, laundry areas or other locations where water may be present.
8. To reduce the risk of fire, do not place or install this unit in areas where the ventilation or circulation ducts may become blocked.
9. Do not insert or allow foreign objects to enter any of the ventilation or circulation ducts as this may cause electric shock, fire or otherwise damage the unit.
10. The unit's power supply cord must be connected to a properly grounded and protected, 120-volt electrical outlet. Always use ground fault protection where required by the electrical code. To reduce the risk of fire, avoid running power supply cord under rugs, carpets, etc. Keep the power supply cord away from high traffic area where it may pose a tripping hazard.
11. Avoid the use of an extension cord because the extension cord may overheat and cause a risk of fire. However, if you have to use an extension cord, the cord should be No. 14 AWG minimum size with a grounding plug and rated not less than 1875 WATTS.

SAFETY INFORMATION

Continued

12. Always disconnect the unit from the power supply before performing any cleaning, light bulb replacement, maintenance, relocating the heater or when the unit is not in use for long periods of time.
13. When transporting or storing the unit, keep it in a dry location, free from dust, excessive vibration or other factors, which may damage the unit.

LISTING APPROVALS

This heater has been tested in accordance with the CSA Standards for fixed and location-dedicated electric room heaters in the United States. All components are UL or CSA safety certified.

If you need assistance during installation, please contact your local dealer or the DESA Heating Products Technical Services Department at 1-866-672-6040.

UNPACKING AND TESTING THE UNIT

Carefully remove the unit from the box. Prior to permanently installing the unit, test to make sure the unit operates properly by plugging the power supply cord into a conveniently located 120-volt grounded outlet.

⚠ CAUTION: The unit's power supply cord must be connected to a properly grounded and protected 120-volt outlet. Always use ground fault protection where required by the electrical code.

⚠ WARNING: Do not operate the unit if it is damaged or has malfunctioned. If you suspect the unit is damaged, return the unit to an authorized service facility for examination, electrical or mechanical adjustment or repair.

PRODUCT DIMENSIONS & SPECIFICATIONS

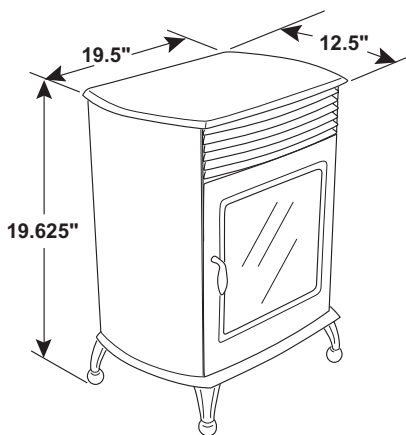

Figure 1 - Heater Dimensions

Model:	CGESBM
Frequency	60 Hz
Heater Power	1500 W
Heater Output	5000 BTUs
Power Supply	120V; 15 Amp Grounded, Circuit

Note: A dedicated power supply circuit is recommended for the unit but not required. Additional electrical appliances on the same circuit may exceed the current (amperage) rating for that circuit. If after the installation of your unit, the circuit breaker trips or the fuse fails on a repeated basis, then a dedicated circuit will likely be required. Any new wiring must be done in compliance with local and national codes and other applicable regulations in order to reduce the risk of fire, electric shock or other injuries. Therefore, it is strongly recommended that you hire a licensed electrician to complete any such work.

GROUNDING INSTRUCTIONS

This stove is for use on 120 volts. The cord has a plug as shown in Figure 2. An adapter is available for connecting three-blade grounding-type plugs to two-slot receptacles. The green grounding lug extending from the adapter must be connected to a permanent ground such as a properly grounded outlet box. The adapter should not be used if a three-slot grounded receptacle is available.

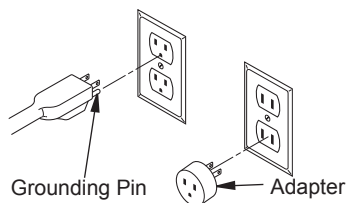

Figure 2 - Grounding Methods

OPERATING INSTRUCTIONS

Once the unit has been properly connected to a ground electrical outlet, it is ready to operate.

Note: Ensure the circuit breakers for power supply are turned on.

CONTROL PANEL OPERATION

Controls are located on the back of the unit (see Figure 3).

1. **Main ON/OFF power switch:** This switch is located at the furthest right corner on the control panel when looking at the back of the unit. Turn the switch to ON and unit will be ready to operate. The "I" indicates ON and "O" indicates OFF.
2. **Heater Switch and Control Dial:** The heater switch has a sun directly below it. To turn the heater on, flip the Heater Switch to ON position (the "I" indicates ON and "O" indicates OFF). The Control Knob has a thermometer below it. Turn the dial clockwise past the number 8. You should hear a small clicking sound indicating the heater has started and heat will emit from the vents at the top of the unit. To turn off heater, turn the temperature dial counter clockwise past number 1 and flip the Heater Switch to OFF position.

To increase the desired temperature, turn the temperature dial clockwise towards Number 8.

To decrease the desired temperature, turn the temperature dial counter clockwise towards number 1. The heater has a built-in thermostat so it will shut off automatically once the set temperature is reached. It will also turn on automatically if the room temperature drops below the set temperature on the dial.

Note: When the heater is turned on for the first time, it may release a slight, harmless odor. This odor is a normal occurrence caused by the initial heating of the internal heating elements and should not occur again.

4. **Flame Control Dial:** This dial controls the intensity of the flame.

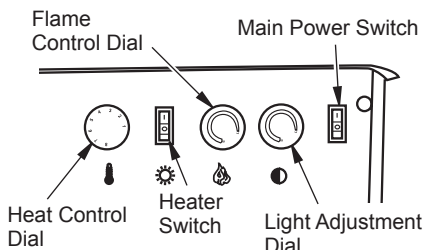

Figure 3 - Electric Stove Control Panel

CLEANING AND MAINTENANCE

WARNING: Always disconnect power and allow the heater to cool before performing any cleaning, maintenance or relocation of this heater. Turn controls to OFF and remove plug from outlet or turn off circuit breaker to heater.

Turn off heater and circuit breaker to heater before performing any cleaning and/or maintenance. Allow heater to cool completely.

BULB REPLACEMENT

WARNING: The halogen light bulbs in your unit can become extremely hot. Allow at least 10 minutes between turning off the heater and removing the light bulbs to avoid accidental burns.

CLEANING AND MAINTENANCE

Continued

There are a total of 7 halogen light bulbs (type GX6.35 rated 120 volts, 35 watts) in your unit.

- 2 bulbs provide illumination for the ember bed beneath the log set
- 2 bulbs provide illumination for the flame generation assembly
- 1 bulb provides illumination for the top contrasting light
- 2 bulbs for replacement

Most halogen light bulbs are rated to last approximately 1800 hours. Like all light bulbs, halogen bulbs require periodic replacement. When the bulbs in your unit have burned out you will notice one or more of the following:

- Contrasting light is dark
- Flame is dim or dark in certain areas
- Log set ember bed appears dim or dark in certain areas

⚠ WARNING: Do not install replacement bulbs that exceed specified maximum watts.

Your unit must be opened in order to replace the light bulbs. To reduce the number of times you need to open the unit, replace all bulbs at the same time.

Removing Front of Unit

1. Unplug unit from the power supply.
2. Remove the four screws in front of the unit that secure the grill to the main frame (see Figure 4).
3. Four clips hold the front panel to the frame of the unit. Lift the front panel upwards until the clips disconnect. Remove and place face up on the floor.

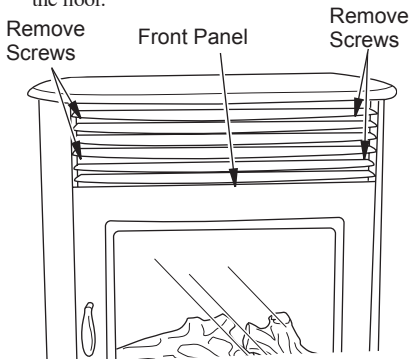

Figure 4 - Stove Front Panel Removal

Replacing Top Contrasting Bulb

1. The top contrasting light is mounted on the underside of the top "shelf".
2. Carefully remove spring clip. Hold socket and pull out the old bulb.
3. Hold socket and push in new bulb (DO NOT exceed wattage). Replace spring clip.

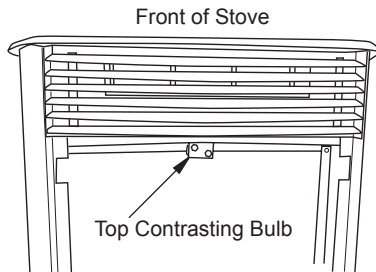

Figure 5 - Replacing Top Contrasting Bulb

Replacing Log Set Ember Bed Bulbs

1. Remove two screws from grate that secures log set to frame.
2. From the bottom, lift up the log set ember bed and remove it from the unit (do not pull up on logs).
3. Remove spring clip from bulb. Hold socket and pull out old bulb.
4. Hold socket and push in new bulb. Replace spring clip.

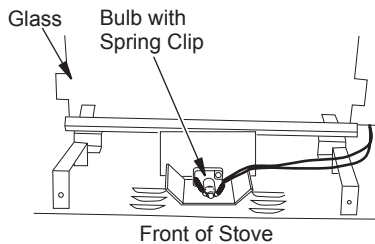

Figure 6 - Ember Bed Bulb Replacement

CLEANING AND MAINTENANCE

Continued

Replacing Flame Generation Bulbs

1. Remove the 6 screws from back of stove shown in Figure 7. Remove back plate.
2. Locate the flame generation cylindrical drum. It is constructed of two removable halves; either of which can be removed from the unit.
3. Squeeze half of drum cylinder until it's top edge clears the top drum track. Remove bottom edge of cylinder drum from bottom drum track. This will give you access to the light bulbs. **Note:** Do not exert excessive pressure on drum cylinder as this may cause damage.
4. Remove spring clip. Hold socket and pull out old bulb.
5. Hold socket and push in new bulb (DO NOT exceed wattage). Replace spring clip.
6. Repeat steps 4 and 5 for second bulb.
7. Insert bottom edge of removed cylinder half into bottom drum track. Gently squeeze drum cylinder until it's top edge fits into top drum rack.
8. Secure the rear cover of the unit to the main frame by reattaching screws removed in step 1.
9. Replace the log set ember bed.
10. Replace the grate to secure the log set.
11. Carefully replace front panel by sliding it downward until the clips reconnect.
12. Replace the grill to front of unit using screws removed earlier.

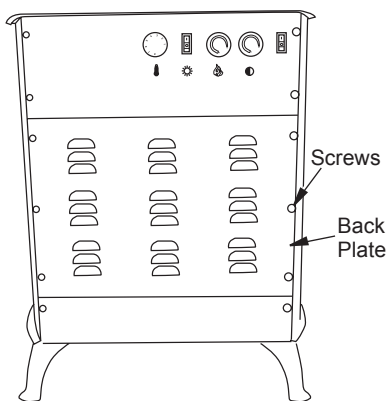

Figure 7 - Locating Flame Generation Cylinder

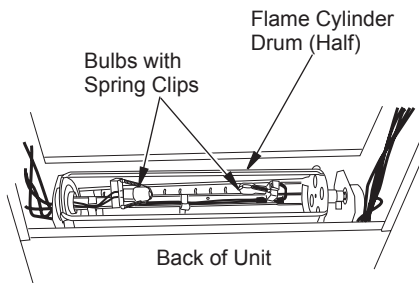

Figure 8 - Flame Generation Cylinder Drum Bulb Replacement

CLEANING FRONT PANEL GLASS

WARNING: When cleaning unit, the power supply should be disconnected and the unit should be cool.

Over time the front glass panel may become dirty or dusty. Dust can be removed by lightly rubbing the glass surface with a clean, lint free cloth or paper towel. To remove fingerprints or other marks, use a damp cloth with a good quality household glass cleaner. The front glass panel should be completely dried with a clean, lint free cloth or paper towel.

CAUTION: Do not use abrasive cleaners on glass panel. Do not spray liquids directly onto any surface of the unit.

WARNING: An authorized service representative should perform any other servicing.

STORAGE

When not in use, unplug the unit from the power supply and store in dry, dust free location.

TECHNICAL SERVICE

You may have further questions about your electric stove. If so, contact DESA Heating Products' Technical Service Department at 1-866-672-6040. When calling please have your model and serial numbers of your heater ready.

You can also visit DESA Heating Products' technical services web site at www.desatech.com.

REPLACEMENT PARTS

Note: Use only original replacement parts. This will protect your warranty coverage for parts replaced under warranty.

PARTS UNDER WARRANTY

Contact authorized dealers of this product. If they can't supply original replacement part(s), call DESA Heating Products' Technical Service Department at 1-866-672-6040.

When calling DESA Heating Products, have ready

- your name
- your address
- model and serial numbers of your heater
- how heater was malfunctioning
- purchase date

Usually, we will ask you to return the part to the factory.

PARTS NOT UNDER WARRANTY

Contact authorized dealers of this product. If they can't supply original replacement part(s), call DESA Heating Products at 1-866-672-6040 for referral information.

When calling DESA Heating Products, have ready

- model number of your heater
- the replacement part number

TROUBLESHOOTING



WARNING: Turn off appliance and let cool before servicing. Only a qualified service person should service and repair heater.

OBSERVED PROBLEM	POSSIBLE CAUSE	REMEDY
Stove turns off and will not turn on	1. Stove has overheated and safety device has cause thermal switch to disconnect or home circuit breaker has opened	1. Reset switch by turning main power switch off and waiting 5 minutes then turning it back on
Flame is not moving	1. Loose wiring 2. Flame motor defective	1. Inspect wiring for loose connections 2. Call a qualified service technician to replace flame motor
Dim or poorly visible flame	1. Bulb(s) are burnt out 2. Wiring is loose	1. Inspect bulbs and replace if necessary 2. Inspect wiring for loose connections and repair or replace if necessary
Log set and/or ember is not glowing	1. Bulb(s) are burnt out	1. Inspect bulbs and replace if necessary
Flame sputters	1. Flame motor is defective	1. Call a qualified service technician to replace flame motor

WARRANTY INFORMATION

KEEP THIS WARRANTY

Model _____
Serial No. _____
Date Purchased _____

Always specify model and serial numbers when communicating with the factory.

We reserve the right to amend these specifications at any time without notice. The only warranty applicable is our standard written warranty. We make no other warranty, expressed or implied.

LIMITED WARRANTY ELECTRIC STOVE

DESA Heating Products warrants this product to be free from defects in materials and components for one (1) year from the date of first purchase (excluding bulbs and fuses), provided that the product has been properly installed, operated and maintained in accordance with all applicable instructions. To make a claim under this warranty the Bill of Sale or cancelled check must be presented.

This warranty is extended only to the original retail purchaser. This warranty covers the cost of part(s) required to restore this heater to proper operating condition (excluding bulbs and fuses) and an allowance for labor when provided by a DESA Heating Products Authorized Service Center. Warranty part(s) MUST be obtained through authorized dealers of this product and/or DESA Heating Products who will provide original factory replacement parts. Failure to use original factory replacement parts voids this warranty. The heater MUST be installed by a qualified installer in accordance with all local codes and instructions furnished with the unit.

This warranty does not apply to parts that are not in original condition because of normal wear and tear or parts that fail or become damaged as a result of misuse, accidents, lack of proper maintenance or defects caused by improper installation. Travel, diagnostic cost, labor, transportation and any and all such other costs related to repairing a defective heater will be the responsibility of the owner.

TO THE FULL EXTENT ALLOWED BY THE LAW OF THE JURISDICTION THAT GOVERNS THE SALE OF THE PRODUCT; THIS EXPRESS WARRANTY EXCLUDES ANY AND ALL OTHER EXPRESSED WARRANTIES AND LIMITS THE DURATION OF ANY AND ALL IMPLIED WARRANTIES, INCLUDING WARRANTIES OF MERCHANTABILITY AND FITNESS FOR A PARTICULAR PURPOSE TO ONE (1) YEAR ON ALL COMPONENTS FROM THE DATE OF FIRST PURCHASE; AND DESA HEATING PRODUCTS' LIABILITY IS HEREBY LIMITED TO THE PURCHASE PRICE OF THE PRODUCT AND DESA HEATING PRODUCTS SHALL NOT BE LIABLE FOR ANY OTHER DAMAGES WHATSOEVER INCLUDING INDIRECT, INCIDENTAL OR CONSEQUENTIAL DAMAGES.

Some states do not allow a limitation on how long an implied warranty lasts or an exclusion or limitation of incidental or consequential damages, so the above limitation on implied warranties or exclusion or limitation on damages may not apply to you.

This warranty gives you specific legal rights and you may also have other rights that vary from state to state.

For information about this warranty write:

DESATM
HEATING PRODUCTS
2701 Industrial Drive
P.O. Box 90004
Bowling Green, KY 42102-9004
www.desatech.com



117191 01

NOT A UPC

117191-01
Rev. A
05/05

Free Manuals Download Website

<http://myh66.com>

<http://usermanuals.us>

<http://www.somanuals.com>

<http://www.4manuals.cc>

<http://www.manual-lib.com>

<http://www.404manual.com>

<http://www.luxmanual.com>

<http://aubethermostatmanual.com>

Golf course search by state

<http://golfingnear.com>

Email search by domain

<http://emailbydomain.com>

Auto manuals search

<http://auto.somanuals.com>

TV manuals search

<http://tv.somanuals.com>