

ALL-PRO®

PORTABLE HEATERS

Propane/LP Patio Heater Owner's Manual

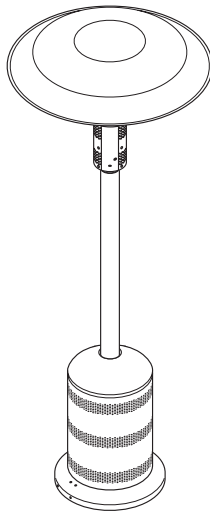

GAS FIRED



LISTED 86NH

⚠ WARNING: For outdoor use only.

MODELS SPC-54PHW, SPC-54PHB, AND SPC-54PHT

IMPORTANT: Read and understand this manual before assembling, starting or servicing heater. Improper use of heater can cause serious injury. Keep this manual for future reference.

⚠ GENERAL HAZARD WARNING:

Failure to comply with the precautions and instructions provided with this heater, can result in death, serious bodily injury and property loss or damage from hazards of fire, explosion, burn, asphyxiation, carbon monoxide poisoning, and/or electrical shock.

Only persons who can understand and follow the instructions should use or service this heater.

If you need assistance or heater information such as an instructions manual, labels, etc. Contact the manufacturer.

Save this manual for future reference.
For more information, visit www.desatech.com

TABLE OF CONTENTS

Specifications	2	Servicing.....	8
Safety Information	2	Replacement Parts	9
Propane/LP Safety	4	Technical Service	9
Assembly Instructions	5	Illustrated Parts Breakdown and Parts List	10
Operating Instructions	7	Warranty and Repair Service	12
Storage.....	8		

SPECIFICATIONS

Rating	40,000 Btu/hr (11.7 kW)
Type of Gas	Propane/LP Only
Gas Supply Pressure to regulator	Maximum - 150 psi (1034.2 kPa) Minimum - 5 psi (34.5 kPa)
Gas Supply Pressure Regulator out	11" W.C. (2.74 kPa)
Ignition	Piezo Ignition
Fuel Consumption	1.86 lbs./hr (.84 kg/hr)
Flame Safety	Thermocouple Operated Gas Valve

SAFETY INFORMATION

 **WARNING: This product contains and/or generates chemicals known to the State of California to cause cancer or birth defects, or other reproductive harm.**

 **WARNING: Not for home or recreational vehicle use.**

 **WARNING: Fire, burn, inhalation, and explosion hazard. Keep solid combustibles, such as building materials, paper or cardboard, a safe distance away from the heater as recommended by the instructions. Never use the heater in spaces which do or may contain volatile or airborne combustibles, or products such as gasoline, solvents, paint thinner, dust particles or unknown chemicals.**

We cannot foresee every use which may be made of our heaters. Check with your local fire safety authority if you have questions about heater use. Other standards govern the use of fuel gases and heat producing products for specific uses. Your local authorities can advise you about these.

Carbon Monoxide Poisoning: Direct-Fired means that all of the combustion products enter the heated space. Even though this heater operates very close to 100 percent combustion efficiency, it still pro-

duces small amounts of carbon monoxide. Some people are more affected by carbon monoxide than others. Early signs of carbon monoxide poisoning resemble the flu, with headaches, dizziness, and/or nausea. If you have these signs, the heater may not be working properly. **Get fresh air at once!** Check for proper ventilation and have heater serviced.

Propane Gas: Propane gas is odorless. An odor-making agent is added to propane gas. The odor helps you detect a propane gas leak. However, the odor added to propane gas can fade. Propane gas may be present even though no odor exists.

This is a propane, direct-fired heater. Propane is heavier than air. If propane leaks from a connection or fitting, it sinks to the floor, collecting there with the surrounding air, forming a potentially explosive mixture. Obviously, propane leaks should be avoided, so set up the propane supply with utmost care. Read *Propane/LP Safety*, page 4 for additional information about detecting propane leaks. Leak check new connections or reconnections with a soap and water solution and follow all connection instructions herein. Also, ask your propane dealer for advice on the propane application and supply installation and ask them to check it if there are any questions.

When the heater is to be operated in the presence of other people the user is responsible for properly acquainting those present with the safety precautions and instructions, and of the hazards involved.

Make certain you read and understand all warnings. Keep this manual for reference. It is your guide to safe and proper operation of this heater.

1. Check the heater thoroughly for damage. DO NOT operate a damaged heater.
2. DO NOT modify the heater or operate a heater which has been modified from its original condition.

SAFETY INFORMATION

Continued

3. Use only propane/LP gas.
4. Use only VAPOR WITHDRAWAL propane supply. The propane cylinder must be arranged for vapor-withdrawal, in accordance with the *Compress Gas Associations, Small Propane Bottle Assembly*. If there is any question about vapor withdrawal, ask your propane dealer.
5. Never use the heater if the ballast weight is not assembled onto the base. The base must be weighted to avoid tipping.
6. Use only the hose and regulator assembly provided with the heater.
7. Inspect hose assembly before each use of the heater. If there is excessive abrasion or wear, or hose is cut, replace with hose assembly listed on parts list before using heater.
8. This heater is for **OUTDOOR USE ONLY**, even so, make sure that there is ample fresh air ventilation. Do not use in buildings, garages or other enclosed spaces.
9. If at any time gas odor is detected, **IMMEDIATELY DISCONTINUE** operation until the source of gas has been located and corrected. Read *Propane Safety*, page 4 for additional information about detecting propane leaks.
10. Install the heater such that it is not directly exposed to water spray, rain and/or dripping water.
11. Maintain minimum clearance to people or normal combustible material (like paper) of 3.6 ft. (1100 mm) from top and 2 ft. (609 mm) from the reflector.
12. Operate only on a stable, level surface.
13. Do not spray aerosols near the heater during use or shortly thereafter.
14. Do not clean heater with combustible or corrosive cleaners. Use warm, soapy water.
15. Check control compartment burners and circulation air passageways for free air passage, make sure that there are no obstructions. These areas are a common location for spider webs, which can present a dangerous condition, damage the heater and render it unsafe for use. The heater must be checked if any of the following conditions exist:
 - a) Gas smell along with predominate yellow tipping of the burner.
 - b) Heater does not reach temperature.
 - c) Uneven burner glow.
 - d) Burner makes popping noises during normal use, other than during shutdown.
16. Use only soapy water (1 part liquid dishwashing detergent to 3 parts water) to conduct Leak Tests whenever a propane cylinder is connected. Bubbles indicate a leak.
17. Do not adjust gas regulator. If you are unsure of your appliances gas type or pressure, call out a gas fitter or plumber.
18. Place the control knob on "OFF" position when heater is not in use.
19. Always disconnect the gas supply after the heater is turned "OFF".
20. Do not move, handle or service while hot or burning.
21. Allow 45 minutes to cool down after use before attempting to move heater.
22. Do not operate this appliance in windy conditions. Maximum allowable wind speed is 10 mph (16 Km/h).
23. Do not operate this appliance in temperature conditions below 40° F (5° C).
24. Keep heater away from areas where flammable liquids, vapors or solids are stored or used.
25. If operated in salt air environments, the unit will require more frequent cleaning; otherwise, the longevity of the unit will deteriorate rapidly. Use warm soapy water to clean the unit.
26. Items or material, when stored under the heater, will be subjected to radiant heat and could be seriously damaged.
27. Use only in accordance with local codes, or in the absence of local codes, with the *National Fuel Gas Code ANSI Z223.1*.

Any guard or other protective device removed for servicing must be replaced prior to operating the heater.

Surface temperatures become very hot when operating heater. Children and adults should stay away to avoid burns or clothing ignition.

Young children should be carefully supervised when they are in the area of the heater.

Clothing or other flammable materials should not be hung from the heater, or placed on or near heater.

Installation and repair should be done by a qualified service person. The heater should be inspected before use and at least annually by a qualified service person. More frequent cleanings may be required as necessary. It is imperative that control compartments, burners, and circulating air passageways of the heater be kept clean.

CAUTION: The gas pressure regulator provided with this appliance must be used. This regulator is set for an output pressure of 11" W.C. (2.74 kPa).

PROPANE/LP SAFETY

WARNING: For outdoor use only.

ASPHYXIATION HAZARD

- Do not use this heater for heating human living quarters.
- Do not use in unventilated areas.
- The flow of combustion and ventilation air must not be obstructed.
- Proper ventilation air must be provided to support the combustion air requirements of the heater being used.
- Refer to the specification section of the heater's manual, heater data plate, or contact DESA Heating Products to determine combustion air ventilation requirements of the heater.
- Lack of proper ventilation air will lead to improper combustion.
- Improper combustion can lead to carbon monoxide poisoning leading to serious injury or death. Symptom of carbon monoxide poisoning can include headaches, dizziness and difficulty in breathing.

ASSEMBLY INSTRUCTIONS

Tools Required:

- | | |
|-----------------------------|---|
| #2 Philips Head Screwdriver | 1 |
| Adjustable Wrench | 2 |

Inspect heater components for possible shipping damage. If any is found, immediately notify the dealer. Check to make sure that all components are included with your heater (see pages 10 and 11).

POLE ASSEMBLY

1. Attach legs to base using large bolts (2), lock washers (2), and large nuts (2 per leg). See Figure 1. Insert bolts from through legs and into top of base. Attach lock washers and nuts from underneath base. Finger tighten only. Do not fully tighten until next step.
2. Secure pole support to legs using 6 large bolts, lock washers and large nuts per leg. Wrench tighten the nuts and bolts from step 1 (see Figure 1).
3. Attach ballast weight to base using one, long bolt, large lock washer and large nut (see Figure 1).

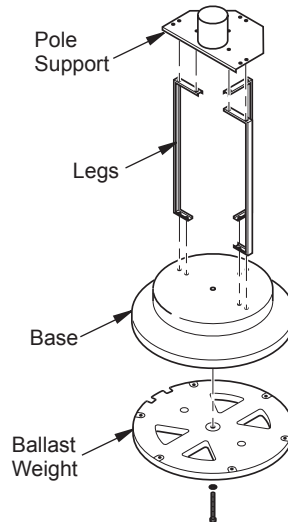

Figure 1 - Base Assembly

ASSEMBLY INSTRUCTIONS

Continued

- Insert manifold into pole support (see Figure 2). Insert the manifold assembly through the post by passing through the hole in the post support.
Note: Make sure hose and regulator assembly attached to manifold are never bent or kinked during installation and operation of heater.
- Attach pole to pole support (Figure 3). Place pole into pole support center connector. Tighten six set screws with hex allen wrench supplied with heater. **Note:** Set screws are threaded inside post support.
- Put propane/LP cylinder cover on base assembly (see Figure 4). Slide propane/LP cylinder cover over pole and pole support. Be sure that propane/LP cylinder cover rests level on the base.

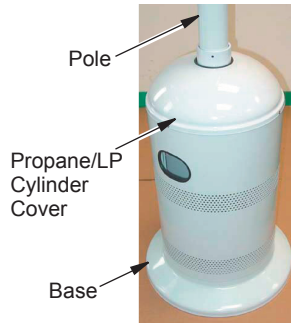

Figure 4 - Propane/LP Cylinder Cover

BURNER AND CONTROL ASSEMBLY

The connection between the fuel line to the burner is a quick connect connection type. Follow these steps to assemble, while referring to Figure 5:

- Pull manifold out of top end of pole.
- Slide/move quick connect collar of manifold to the back.
- Attach manifold to burner and control assembly by pushing burner and control assembly connection all the way through manifold.
- Make sure manifold and burner assembly snap in properly.
- Release the quick connect collar of manifold that was slid to the back in step 2.
- Place burner and control assembly onto pole.

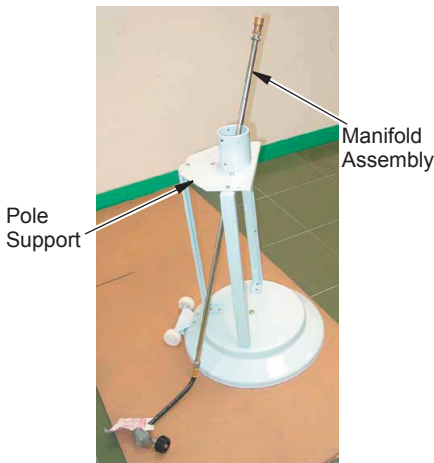

Figure 2 - Installing Manifold Assembly

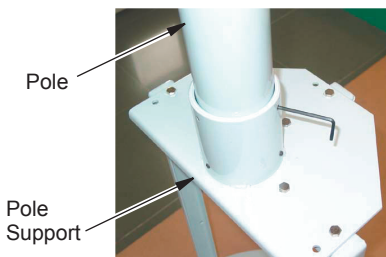

Figure 3 - Pole to Pole Support

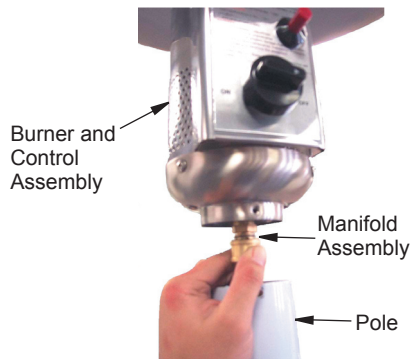

Figure 5 - Connecting Manifold Assembly to Burner and Control Assembly

ASSEMBLY INSTRUCTIONS

Continued

CHECK FOR LEAKS

IMPORTANT: The heater must be leak tested before any further assembly is done. Use only a soap and water solution. **DO NOT USE FLAME.**

Turn control knob to the "OFF" position. Securely connect regulator to propane/LP gas cylinder. Open propane/LP cylinder valve. Apply a soap and water solution to connections at the manifold, burner, and control assembly. Bubbles forming show a leak. In case of any leaks, turn off propane/LP cylinder valve, remove manifold, check and clean connection. Reconnect manifold and leak test again.

Upon completion of leak test, and when there is no sign of a leak, turn off propane/LP cylinder valve and disconnect regulator from propane/LP gas cylinder. Remove propane/LP gas cylinder and continue to next step.

POLE AND BURNER/CONTROL ASSEMBLY

Attach pole to burner and control assembly (see Figure 6). Align the three holes. Insert a small bolt in each hole and tighten using #2 Philips head screwdriver.



Figure 6 - Attach Burner and Control Assembly to Pole

MANIFOLD FIXING PLATE AND POLE SUPPORT

1. Locate threaded hole underneath post support. This hole is for mounting manifold fixing plate (see Figure 7).
2. Align holes on manifold fixing plate with threaded holes on pole support.
3. Make sure manifold fixing plate is facing downward see (Figure 7).
4. Use a medium bolt to tighten manifold fixing plate to post support using #2 Philips head screwdriver.
5. Turn manifold fixing plate so it will hold manifold in place.
6. Tighten medium bolt so manifold fixing plate will not move.



Figure 7 - Attaching Manifold Fixing Plate to Post Support

ASSEMBLY INSTRUCTIONS

Continued

DOME AND EMITTER

Gently lay heater assembly on its side using one of the shipping styrofoam inserts to prop up the top half of heater. Align holes in dome with threaded studs in emitter cover. Secure dome to emitter using three cap nuts. Tighten with an adjustable wrench. Stand heater back to upright position.



Figure 8 - Attaching Dome to Emitter

OPERATING INSTRUCTIONS

⚠ WARNING: If you smell gas:

- Shut off gas to the appliance.
- Extinguish any open flames.
- If odor continues, immediately call your gas supplier.

See safety warnings and precautions starting on page 1 of this manual for more information.

PREPARING FOR OPERATION

1. Check heater for possible shipping damage. If any is found, immediately notify the factory.
2. Follow all safety information.
3. Check and assure control knob is in the "OFF" position.
4. Place propane/LP gas cylinder inside cylinder base. Securely connect regulator to propane/LP gas cylinder.
5. Turn cylinder valve on. Apply a soap and water solution to connection at regulator and cylinder. Bubbles forming show a leak.
6. In case of any leaks, turn off propane/LP cylinder valve, undo leaking connection. Check and clean connection. Reconnect regulator and leak test again.

START

1. Purge gas line leading to pilot assembly. Press and turn control knob to HIGH position, keeping it pressed in for 1 to 2 minutes. **Note:** When a new or refilled gas cylinder is installed, heater will need to be purged again.
2. To light the pilot:
 - a) Press control knob and turn to the PILOT position.
 - b) Hold control knob in and press ignition button until the pilot lights.
 - c) Keep control knob depressed for 30 seconds to heat thermocouple.
 - d) Release control knob and pilot should remain lit. **Note:** To visually check ignition of pilot, slide viewing hole cover to either side.
 - e) Once pilot flame stays on, close viewing hole cover.

OPERATING INSTRUCTIONS

Continued

⚠ CAUTION: Do not attempt to slide the viewing hole cover when the main burner is lighting, operating or hot.

3. Set the heat level.
 - a) Press and turn control knob to the HIGH position, Burner will light immediately.
 - b) Press and turn control knob to the desired heat level. *Note:* While in use, burner flame should be mainly blue in appearance with a small amount of yellow.

IMPORTANT: Smoke and odor (not a gas odor) emission may occur in the first 15 minutes of use. Run heater at high setting for at least 15 minutes to eliminate this problem.

⚠ WARNING: If you smell gas while in use, immediately press and turn control knob to the "OFF" position to shutdown heater.

STOP

1. Press and turn control knob to the PILOT position. Burner will extinguish but pilot will stay on.
2. To extinguish pilot, press and turn control knob to the OFF position.
3. Turn off gas supply.
4. Do not attempt to relight the heater for 5 minutes after propane/LP cylinder valve has been closed.

RESTART HEATER

1. Turn gas control knob to the OFF position.
2. Wait 5 minutes.
3. Restart following *Start* procedure.

STORAGE

1. Allow at least 45 minutes for heater to cool down after using.
2. Store heater upright in a sheltered area away from inclement weather and dust.
3. If desired, cover heater after heater has cooled.
4. If heater is not to be used for an extended period of time, disconnect and remove propane/LP gas cylinder and store in accordance with the *Standard for Storage and Handling of Liquefied Petroleum Gases, ANSI/INFPA 58.*

SERVICING

To assure safety, proper function and longevity of the heater, regular maintenance is required. The frequency of maintenance will depend on the usage of the unit. Review the following concerning the criteria for a properly functioning heater. Failing to follow proper, regular maintenance will void warranty.

A hazardous condition may result if a heater is used that has been modified or is not functioning properly. When the heater is working properly:

- The flame is contained within the heater.
- The flame is essentially blue with perhaps some yellow tipping.
- There is no strong disagreeable odor, eye burning or other physical discomfort.
- There is no smoke or soot internal or external to the heater.
- There are no unplanned or unexplained shut downs of the heater.

The parts lists and wiring diagram show the heater as it was constructed. Do not use a heater which is different from that shown. In this regard, use only the hose, regulator and cylinder connection fitting (called a POL fitting) supplied with the heater.

IMPORTANT: Do not use alternates. For this heater, the regulator must be set as shown in *Specifications*. If there is any uncertainty about the regulator setting, have it checked.

REPLACEMENT PARTS

 **WARNING: Use only original replacement parts. This heater must use design-specific parts. Do not substitute or use generic parts. Improper replacement parts could cause serious or fatal injuries. This will also protect your warranty coverage for parts replaced under warranty.**

PARTS UNDER WARRANTY

Contact authorized dealers of this product. If they can't supply original replacement part(s), either contact your nearest Parts Central or call DESA Heating Products' Technical Service Department at 1-866-672-6040.

When calling DESA Heating Products, have ready

- your name
- your address
- model number of your heater
- how heater was malfunctioning
- purchase date

PARTS NOT UNDER WARRANTY

Contact authorized dealers of this product. If they can't supply original replacement part(s), either contact your nearest Parts Central (listed in Authorized Service Center booklet) or call DESA Heating Products at 1-866-672-6040 for referral information.

When calling DESA Heating Products, have ready

- model number of your heater
- the replacement part number

TECHNICAL SERVICE

A heater which is not working right must be repaired, but only by a trained, experienced service person. To find the service center closest to you, or if you have further questions about this heater, contact DESA Heating Products' Technical Service Department at 1-866-672-6040. When calling, please have your model and serial numbers of your heater ready.

You can also visit DESA Heating Products' Technical Service web site at www.desatech.com.

You may also obtain in-warranty or out-of-warranty service by taking the product to your local service center.

ILLUSTRATED PARTS BREAKDOWN

MODELS

SPC-54PHW, SPC-54PHB, AND SPC-54PHT

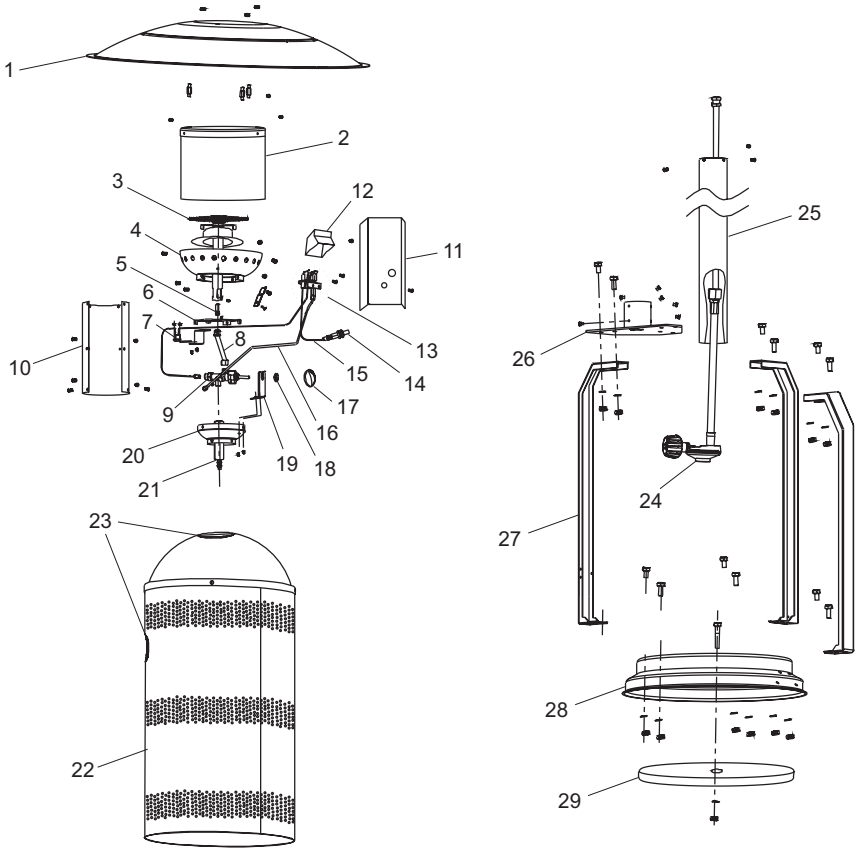

PARTS LIST

This list contains replaceable parts used in your heater. When ordering parts, follow the instructions listed under *Replacement Parts* on page 9 of this manual.

KEY NO.	PART NUMBER	DESCRIPTION	QTY.
1	114133-01	Reflector	1
2	114102-01	Emitter Assembly	1
3	114104-01	Burner Assembly	1
4	114113-01	Burner Cover Bottom	1
5	114126-01	Orifice, Main Burner	1
6	114130-01	Adiabatic Plate	1
7	114138-01	Tip Switch	1
8	114140-01	Fuel Tube	1
9	114142-01	Valve	1
10	114115-01	Valve Housing Cover	1
11	114129-01	Front Cover Panel	1
12	114136-01	Shield, Pilot Wind	1
13	114105-01	Pilot Assembly	1
14	102445-01	Piezo Ignitor Kit	1
15	114117-01	Ignition Wire	1
16	114141-01	Pilot Tube	1
17	114180-01	Knob	1
18	114114-01	Valve Cover Base	1
19	114112-01	Bracket, Valve Mtg	1
21	114101-01	Fuel Line Adaptor	1
22	114139-01	Tank Cover Assembly (White)	1
	114139-03	Tank Cover Assembly (Black)	1
	114139-02	Tank Cover Assembly (Bronze)	1
23	114116-01	Guards, Rubber Handle	1
24	114103-01	Manifold Assembly (Fuel line, hose, regulator)	1
25	114132-01	Pole (White)	1
	114132-02	Pole (Bronze)	1
	114132-04	Pole (Black)	1
26	114137-01	Pole Support (White)	1
	114137-02	Pole Support (Bronze)	1
	114137-03	Pole Support (Black)	1
27	114108-01	Base Legs (Black)	3
	114108-02	Base Legs (Bronze)	3
	114108-03	Base Legs (White)	3
28	114107-01	Base (Black)	1
	114107-03	Base (Bronze)	1
	114107-04	Base (White)	1
29	114131-01	Ballast Plate	1
PARTS AVAILABLE - NOT SHOWN			
	114106-01	Wheel Assembly	1
	114122-01	Model Decal SPC-54	1
	114123-01	Operating Instruction Label	1
	114124-01	Warning Label	1
	114127-01	Hardware Package	1

WARRANTY AND REPAIR SERVICE

KEEP THIS WARRANTY

Model _____

Serial No. _____

Date of Purchase _____

LIMITED WARRANTY

DESA Heating Products warrants this product and any parts thereof, to be free from defects in materials and workmanship for one (1) year from the date of first purchase when operated and maintained in accordance with instructions. This warranty is extended only to the original retail purchaser, when proof of purchase is provided.

This warranty covers only the cost of parts and labor required to restore the product to proper operating condition. Transportation and incidental costs associated with warranty repairs are not reimbursable under this warranty.

Warranty service is available only through authorized dealers and service centers.

This warranty does not cover defects resulting from misuse, abuse, negligence, accidents, lack of proper maintenance, normal wear, alteration, modification, tampering, contaminated fuels, repair using improper parts, or repair by anyone other than an authorized dealer or service center. Routine maintenance is the responsibility of the owner.

THIS EXPRESS WARRANTY IS GIVEN IN LIEU OF ANY OTHER WARRANTY EITHER EXPRESSED OR IMPLIED, INCLUDING WARRANTIES OF MERCHANTABILITY AND FITNESS FOR A PARTICULAR PURPOSE.

DESA Heating Products assumes no responsibility for indirect, incidental or consequential damages. Some states do not allow the exclusion or limitation of incidental or consequential damages or limitations or exclusions may not apply to you. This Limited Warranty gives you specific legal rights and you may also have other rights which vary from state to state.

This warranty does not cover discoloration due to operation of heater. We reserve the right to amend these specifications at any time without notice. The only warranty applicable is our standard written warranty. We make no other warranty, expressed or implied.

WARRANTY SERVICE

Should your heater require service, return it to your nearest authorized service center. Proof of purchase must be presented with the heater. The heater will be inspected. A defect may be caused by faulty materials or workmanship. If so, DESA Heating Products will repair or replace the heater without charge.

REPAIR SERVICE

Return the heater to your nearest authorized service center. Each Service Center is independently owned and operated. Repairs not covered by the warranty will be billed at standard prices. We reserve the right to amend these specifications at any time without notice.

For information about this warranty write:



2701 Industrial Drive
P.O. Box 90004
Bowling Green, KY 42102-9004
ATTN: Customer Service Department



114144 01

NOT A UPC

114144-01
Rev. B
07/04

Free Manuals Download Website

<http://myh66.com>

<http://usermanuals.us>

<http://www.somanuals.com>

<http://www.4manuals.cc>

<http://www.manual-lib.com>

<http://www.404manual.com>

<http://www.luxmanual.com>

<http://aubethermostatmanual.com>

Golf course search by state

<http://golfingnear.com>

Email search by domain

<http://emailbydomain.com>

Auto manuals search

<http://auto.somanuals.com>

TV manuals search

<http://tv.somanuals.com>