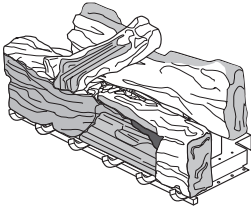


DESA™

HEATING PRODUCTS

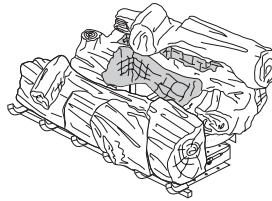
UNVENTED (VENT-FREE) GAS LOG HEATER OWNER'S OPERATION AND INSTALLATION MANUAL

Echo Valley Oak Log Design



**24" VARIABLE MANUALLY-
CONTROLLED MODELS
LSL3124N AND LSL3124P**

Meadowbrook Oak Log Design



**24" VARIABLE
THERMOSTATICALLY-
CONTROLLED MODELS
CDL3924NT AND CDL3924PT**



WARNING: If the information in this manual is not followed exactly, a fire or explosion may result causing property damage, personal injury or loss of life.

- Do not store or use gasoline or other flammable vapors and liquids in the vicinity of this or any other appliance.
- **WHAT TO DO IF YOU SMELL GAS**
 - Do not try to light any appliance.
 - Do not touch any electrical switch; do not use any phone in your building.
 - Immediately call your gas supplier from a neighbor's phone. Follow the gas supplier's instructions.
 - If you cannot reach your gas supplier, call the fire department.
- Installation and service must be performed by a qualified installer, service agency or the gas supplier.

Save this manual for future reference.
For more information, visit www.desatech.com

Download from www.Somanuals.com. All Manuals Search And Download.

WARNING: Improper installation, adjustment, alteration, service or maintenance can cause injury or property damage. Refer to this manual for correct installation and operational procedures. For assistance or additional information consult a qualified installer, service agency or the gas supplier.

WARNING: This appliance is for installation only in a solid-fuel burning masonry or UL127 factory-built fireplace or in a listed ventless firebox enclosure. It is design-certified for these installations in accordance with ANSI Z21.11.2. Exception: Do not install this appliance in a factory-built fireplace that includes instructions stating it has not been tested or should not be used with unvented gas logs.

WARNING: This is an unvented gas-fired heater. It uses air (oxygen) from the room in which it is installed. Provisions for adequate combustion and ventilation air must be provided. Refer to *Air for Combustion and Ventilation* section on page 5 of this manual.

This appliance may be installed in an aftermarket,* permanently located, manufactured (mobile) home, where not prohibited by local codes.

This appliance is only for use with the type of gas indicated on the rating plate. This appliance is not convertible for use with other gases.

* Aftermarket: Completion of sale, not for purpose of resale, from the manufacturer

TABLE OF CONTENTS

Safety Information	3	Cleaning and Maintenance.....	21
Local Codes	4	Troubleshooting	22
Unpacking	4	Optional Positioning of Thermostat Sensing Bulb ...	25
Product Identification	5	Specifications	26
Product Features	5	Accessories	27
Air For Combustion and ventilation	5	Service Hints	27
Installation	8	Technical Service	27
Operating heater	16	Replacement Parts	27
Manually-Controlled Models	16	Illustrated Parts Breakdown and Parts List	28
Inspecting burners.....	20	Warranty Information	32

SAFETY INFORMATION

⚠ WARNING: This product contains and/or generates chemicals known to the State of California to cause cancer or birth defects or other reproductive harm.

IMPORTANT: Read this owner's manual carefully and completely before trying to assemble, operate or service this heater. Improper use of this heater can cause serious injury or death from burns, fire, explosion, electrical shock and carbon monoxide poisoning.

⚠ DANGER: Carbon monoxide poisoning may lead to death!

Carbon Monoxide Poisoning: Early signs of carbon monoxide poisoning resemble the flu, with headaches, dizziness or nausea. If you have these signs, the heater may not be working properly. Get fresh air at once! Have heater serviced. Some people are more affected by carbon monoxide than others. These include pregnant women, people with heart or lung disease or anemia, those under the influence of alcohol and those at high altitudes.

Natural and Propane/LP Gas: Natural and propane/LP gases are odorless. An odor-making agent is added to the gas. The odor helps you detect a gas leak. However, the odor added to the gas can fade. Gas may be present even though no odor exists. Make certain you read and understand all warnings. Keep this manual for reference. It is your guide to safe and proper operation of this heater.

⚠ WARNING: Any change to this heater or its controls can be dangerous.

⚠ WARNING: Do not use a blower insert, heat exchanger insert or other accessory not approved for use with this heater.

⚠ WARNING: Do not allow fans to blow directly into the fireplace. Avoid any drafts that alter burner flame patterns. Ceiling fans can create drafts that alter burner flame patterns. Altered burner patterns can cause sooting.

Due to high temperatures, the appliance should be located out of traffic and away from furniture and draperies.

Do not place clothing or other flammable material on or near the appliance. Never place any objects on the heater.

Heater base assembly becomes very hot when running heater. Keep children and adults away from hot surface to avoid burns or clothing ignition. Heater will remain hot for a time after shutdown. Allow surface to cool before touching.

You must operate this heater with a fireplace screen in place. Make sure fireplace screen is closed before running heater.

Keep the appliance area clear and free from combustible materials, gasoline and other flammable vapors and liquids.

1. This appliance is only for use with the type of gas indicated on the rating plate. This appliance is not convertible for use with other gases.
2. Do not place propane/LP supply tank(s) inside any structure. Locate propane/LP supply tank(s) outdoors (propane/LP units only).

SAFETY INFORMATION

Continued

3. If you smell gas
 - shut off gas supply
 - do not try to light any appliance
 - do not touch any electrical switch; do not use any phone in your building
 - immediately call your gas supplier from a neighbor's phone. Follow the gas supplier's instructions
 - if you cannot reach your gas supplier, call the fire department
4. This heater shall not be installed in a bedroom or bathroom, unless installed as a vented appliance. See *Installing Damper Clamp Accessory for Vented Operation*, page 11.
5. Before installing in a solid fuel burning fireplace, the chimney flue and firebox must be cleaned of soot, creosote, ashes and loose paint by a qualified chimney cleaner. Creosote will ignite if highly heated. Inspect chimney flue for damage. If damaged, repair flue before operating heater.
6. Do not burn solid-fuel in a masonry or UL127 factory-built fireplace in which a vent-free room heater is installed.
7. If fireplace has glass doors, never operate this heater with glass doors closed. If you operate heater with doors closed, heat buildup inside fireplace will cause glass to burst. Make sure there are no obstructions across opening of fireplace.
8. To prevent the creation of soot, follow the instructions in *Cleaning and Maintenance*, page 21.
9. Before using furniture polish, wax, carpet cleaner or similar products, turn heater off. If heated, the vapors from these products may create a white powder residue within burner box or on adjacent walls and furniture.
10. This heater needs fresh, outside air ventilation to run properly. This heater has an Oxygen Depletion Sensing (ODS) safety shutoff system. The ODS shuts down the heater if enough fresh air is not available. See *Air for Combustion and Ventilation*, page 5. If heater keeps shutting off, see *Troubleshooting*, page 22.
11. Do not run heater
 - where flammable liquids or vapors are used or stored
 - under dusty conditions
12. Do not use this heater to cook food or burn paper or other objects.
13. Do not use heater if any part has been exposed to or under water. Immediately call a qualified service technician to inspect the room heater and to replace any part of the control system and any gas control which has been under water.
14. Do not operate heater if any log is broken. Do not operate heater if a log is chipped (dime-sized or larger).
15. Turn heater off and let cool before servicing, installing or repairing. Only a qualified service person should install, service or repair heater.
16. Operating heater above elevations of 4,500 feet may cause pilot outage.
17. To prevent performance problems, do not use propane/LP fuel tank of less than 100 lb. capacity (propane/LP units only).
18. Provide adequate clearances around air openings.

LOCAL CODES

Install and use heater with care. Follow all local codes. In the absence of local codes, use the latest edition of the *National Fuel Gas Code ANSI Z223.1/NFPA 54**.

*Available from:

American National Standards Institute, Inc.
1430 Broadway
New York, NY 10018

National Fire Protection Association, Inc.
Batterymarch Park
Quincy, MA 02269

Note: Where listed vented decorative logs are required, thermostat operation is not permitted.

State of Massachusetts: The installation must be made by a licensed plumber or gas fitter in the Commonwealth of Massachusetts.

Sellers of unvented propane or natural gas-fired supplemental room heaters shall provide to each purchaser a copy of 527 CMR 30 upon sale of the unit.

Vent-free gas products are prohibited for bedroom and bathroom installation in the Commonwealth of Massachusetts.

UNPACKING

⚠ CAUTION: Do not remove the data plates from the grate assembly. The data plates contain important warranty and safety information.

1. Remove logs and heater base assembly from carton. Note: Do not pick up heater base assembly by burners. This could damage heater. Always handle base assembly by grate.
2. Remove all protective packaging applied to logs and heater for shipment.
3. Check all items for any shipping damage. If damaged, promptly inform dealer where you bought heater.

PRODUCT IDENTIFICATION

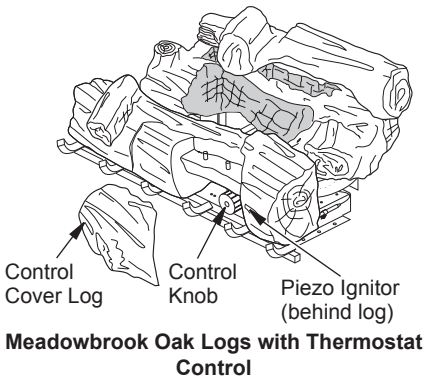
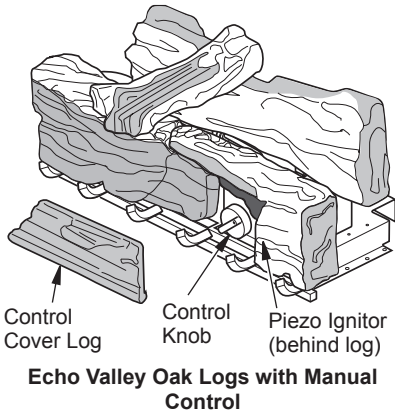


Figure 1 - Product Identification

PRODUCT FEATURES

OPERATION

This heater is clean burning. It requires no outside venting. There is no heat loss out a vent or up a chimney. Heat is generated by realistic flames. This heater is designed for vent-free operation with flue damper closed. It has been tested and approved to ANSI Z21.11.2 standard for unvented heaters. State and local codes in some areas prohibit the use of vent-free heaters. This heater may also be operated as a vented decorative (ANSI Z21.60) product by opening the flue damper.

SAFETY DEVICE

This heater has a pilot with an Oxygen Depletion Sensing (ODS) safety shutoff system. The ODS/pilot is a required feature for vent-free room heaters. The ODS/pilot shuts off the heater if there is not enough fresh air.

PIEZO IGNITION SYSTEM

This heater has a piezo ignitor. This system requires no matches, batteries or other sources to light heater.

AIR FOR COMBUSTION AND VENTILATION

⚠ WARNING: This heaters shall not be installed in a confined space or unusually tight construction unless provisions are provided for adequate combustion and ventilation air. Read the following instructions to insure proper fresh air for this and other fuel-burning appliances in your home.

Today's homes are built more energy efficient than ever. New materials, increased insulation and new construction methods help reduce heat loss in homes. Home owners weather strip and caulk around windows and doors to keep the cold air out and the warm air in. During heating months, home owners want their homes as airtight as possible.

While it is good to make your home energy efficient, your home needs to breathe. Fresh air must enter your home. All fuel-burning appliances need fresh air for proper combustion and ventilation.

Exhaust fans, fireplaces, clothes dryers and fuel burning appliances draw air from the house to operate. You must provide adequate fresh air for these appliances. This will insure proper venting of vented fuel-burning appliances.

PROVIDING ADEQUATE VENTILATION

The following are excerpts from *National Fuel Gas Code, ANSI Z223.1/NFPA 54, Section 5.3, Air for Combustion and Ventilation*.

All spaces in homes fall into one of the three following ventilation classifications:

1. Unusually Tight Construction
2. Unconfined Space
3. Confined Space

The information on pages 5 through 7 will help you classify your space and provide adequate ventilation.

AIR FOR COMBUSTION AND VENTILATION

Continued

Unusually Tight Construction

The air that leaks around doors and windows may provide enough fresh air for combustion and ventilation. However, in buildings of unusually tight construction, you must provide additional fresh air.

Unusually tight construction is defined as construction where:

- walls and ceilings exposed to the outside atmosphere have a continuous water vapor retarder with a rating of one perm (6×10^{-11} kg per pa-sec- m^2) or less with openings gasketed or sealed and
- weather stripping has been added on openable windows and doors and
- caulking or sealants are applied to areas such as joints around window and door frames, between sole plates and floors, between wall-ceiling joints, between wall panels, at penetrations for plumbing, electrical and gas lines and at other openings.

If your home meets all of the three criteria above, you must provide additional fresh air. See *Ventilation Air From Outdoors*, page 7.

If your home does not meet all of the three criteria above, proceed to *Determining Fresh-Air Flow For Heater Location*.

Confined and Unconfined Space

The *National Fuel Gas Code, ANSI Z223.1/NFPA 54* defines a confined space as a space whose volume is less than 50 cubic feet per 1,000 Btu per hour (4.8 m^3 per kw) of the aggregate input rating of all appliances installed in that space and an unconfined space as a space whose volume is not less than 50 cubic feet per 1,000 Btu per hour (4.8 m^3 per kw) of the aggregate input rating of all appliances installed in that space. Rooms communicating directly with the space in which the appliances are installed*, through openings not furnished with doors, are considered a part of the unconfined space.

* Adjoining rooms are communicating only if there are doorless passageways or ventilation grills between them.

DETERMINING FRESH-AIR FLOW FOR HEATER LOCATION

Determining if You Have a Confined or Unconfined Space

Use this work sheet to determine if you have a confined or unconfined space.

Space: Includes the room in which you will install heater plus any adjoining rooms with doorless passageways or ventilation grills between the rooms.

- Determine the volume of the space (length x width x height).

Length x Width x Height = _____ cu. ft.
(volume of space)

Example: Space size 20 ft. (length) x 16 ft. (width) x 8 ft. (ceiling height) = 2560 cu. ft. (volume of space)

If additional ventilation to adjoining room is supplied with grills or openings, add the volume of these rooms to the total volume of the space.

- Multiply the space volume by 20 to determine the maximum Btu/Hr the space can support.

_____ (volume of space) x 20 = (Maximum Btu/Hr the space can support)

Example: 2560 cu. ft. (volume of space) x 20 = 51,200 (maximum Btu/Hr the space can support)

- Add the Btu/Hr of all fuel burning appliances in the space.

Vent-free heater	_____	Btu/Hr
Gas water heater*	_____	Btu/Hr
Gas furnace	_____	Btu/Hr
Vented gas heater	_____	Btu/Hr
Gas fireplace logs	_____	Btu/Hr
Other gas appliances*	+ _____	Btu/Hr
Total	= _____	Btu/Hr

* Do not include direct-vent gas appliances. Direct-vent draws combustion air from the outdoors and vents to the outdoors.

Example:

Gas water heater	_____	40,000	Btu/Hr
Vent-free fireplace	+ _____	33,000	Btu/Hr
Total	= _____	73,000	Btu/Hr

- Compare the maximum Btu/Hr the space can support with the actual amount of Btu/Hr used.

_____ Btu/Hr (maximum the space can support)
_____ Btu/Hr (actual amount of Btu/Hr used)

Example: 51,200 Btu/Hr (maximum the space can support)

73,000 Btu/Hr (actual amount of Btu/Hr used)

The space in the above example is a confined space because the actual Btu/Hr used is more than the maximum Btu/Hr the space can support. You

AIR FOR COMBUSTION AND VENTILATION

Continued

must provide additional fresh air. Your options are as follows:

- Rework worksheet, adding the space of an adjoining room. If the extra space provides an unconfined space, remove door to adjoining room or add ventilation grills between rooms. See *Ventilation Air From Inside Building*.
- Vent room directly to the outdoors. See *Ventilation Air From Outdoors*.
- Install a lower Btu/Hr fireplace, if lower Btu/Hr size makes room unconfined.

If the actual Btu/Hr used is less than the maximum Btu/Hr the space can support, the space is an unconfined space. You will need no additional fresh air ventilation.

⚠ WARNING: If the area in which the heater may be operated is smaller than that defined as an unconfined space or if the building is of unusually tight construction, provide adequate combustion and ventilation air by one of the methods described in the *National Fuel Gas Code, ANSI Z223.1/NFPA 54 Section 5.3* or applicable local codes.

VENTILATION AIR

Ventilation Air From Inside Building

This fresh air would come from an adjoining unconfined space. When ventilating to an adjoining unconfined space, you must provide two permanent openings: one within 12" of the ceiling and one within 12" of the floor on the wall connecting the two spaces (see options 1 and 2, Figure 2). You can also remove door into adjoining room (see option 3, Figure 2). Follow the *National Fuel Gas Code, ANSI Z223.1/NFPA 54, Section 5.3, Air for Combustion and Ventilation* for required size of ventilation grills or ducts.

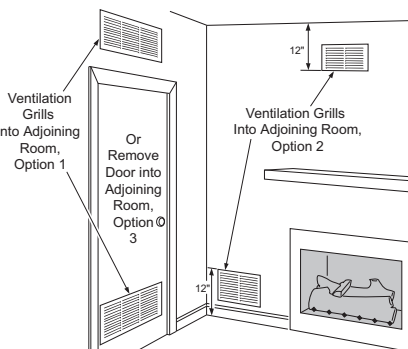


Figure 2 - Ventilation Air from Inside Building

VENTILATION AIR FROM OUTDOORS

Provide extra fresh air by using ventilation grills or ducts. You must provide two permanent openings: one within 12" of the ceiling and one within 12" of the floor. Connect these items directly to the outdoors or spaces open to the outdoors. These spaces include attics and crawl spaces. Follow the *National Fuel Gas Code, ANSI Z223.1/NFPA 54, Section 5.3, Air for Combustion and Ventilation* for required size of ventilation grills or ducts.

IMPORTANT: Do not provide openings for inlet or outlet air into attic if attic has a thermostat-controlled power vent. Heated air entering the attic will activate the power vent.

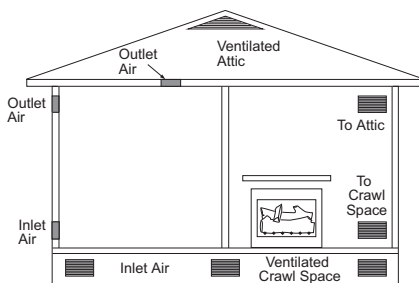


Figure 3 - Ventilation Air from Outdoors

INSTALLATION

NOTICE: This heater is intended for use as supplemental heat. Use this heater along with your primary heating system. Do not install this heater as your primary heat source. If you have a central heating system, you may run system's circulating blower while using heater. This will help circulate the heat throughout the house. In the event of a power outage, you can use this heater as your primary heat source.

⚠ WARNING: A qualified service person must install heater. Follow all local codes.

NOTICE: State or local codes may only allow operation of this appliance in a vented configuration. Check your state or local codes.

⚠ WARNING: Before installing in a solid fuel burning fireplace, the chimney flue and firebox must be cleaned of soot, creosote, ashes and loose paint by a qualified chimney cleaner. Creosote will ignite if highly heated. A dirty chimney flue and firebox may create and distribute soot within the house. Inspect chimney flue for damage. If damaged, repair flue before operating heater.

⚠ WARNING: Seal any fresh air vents or ash clean-out doors located on floor or wall of fireplace. If not, drafting may cause pilot outage or sooting. Use a heat-resistant sealant. Do not seal chimney flue damper.

⚠ WARNING: Never install the heater

- in a bedroom or bathroom unless installed as a vented appliance, see page 11
- in a recreational vehicle
- where curtains, furniture, clothing or other flammable objects are less than 42 inches from the front, top or sides of the heater
- in high traffic areas
- in windy or drafty areas

⚠ CAUTION: This heater creates warm air currents. These currents move heat to wall surfaces next to heater. Installing heater next to vinyl or cloth wall coverings or operating heater where impurities (such as, but not limited to, tobacco smoke, aromatic candles, cleaning fluids, oil or kerosene lamps, etc.) in the air exist, may discolor walls or cause odors.

IMPORTANT: Vent-free heaters add moisture to the air. Although this is beneficial, installing heater in rooms without enough ventilation air may cause mildew to form from too much moisture. See *Air for Combustion and Ventilation*, page 5.

CHECK GAS TYPE

Use the correct gas type (natural or propane/LP) for your unit. If your gas supply is not correct, do not install log set. Call dealer where you bought log set for proper type fireplace.

⚠ WARNING: This appliance is equipped for (natural or propane/LP) gas. Field conversion is not permitted.

INSTALLATION

Continued

INSTALLATION AND CLEARANCES FOR VENT-FREE OPERATION

⚠ WARNING: Maintain the minimum clearances. If you can, provide greater clearances from floor, ceiling and adjoining wall.

MINIMUM FIREPLACE CLEARANCE TO COMBUSTIBLE MATERIALS

Side Wall	Ceiling
16"	42"

LOG SIZING REQUIREMENTS

Minimum Firebox			
Height	Depth	Front Width	Rear * Width
17"	14"	28"	21"

* Measured at 14" depth.

Carefully follow the instructions below. This will ensure safe installation into a masonry, UL127-listed manufactured fireplace or listed vent-free firebox.

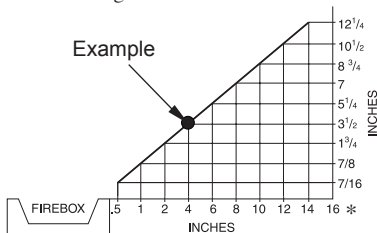
Minimum Clearances For Side Combustible Material, Side Wall and Ceiling

A. Clearances from the side of the fireplace cabinet to any combustible material and wall should follow diagram in Figure 4.

Example: The face of a mantel, bookshelf, etc. is made of combustible material and protrudes 3 1/2" from the wall. This combustible material must be 4" from the side of the fireplace cabinet (see Figure 4).

Note: When installing your gas logs into a manufactured firebox, follow firebox manufacturer's instructions for minimum clearances to combustible materials.

B. Clearances from the top of the fireplace opening to the ceiling should not be less than 42 inches.



*Minimum 16 inches from Side Wall

Figure 4 - Minimum Clearance for Combustible to Wall

NOTICE: Manual control heaters may be used as a vented product. If so, you must always run heater with chimney flue damper open. If running heater with damper open, noncombustible material above fireplace opening is not needed. Go to *Installing Damper Clamp Accessory for Vented Operation*, page 11.

MINIMUM NONCOMBUSTIBLE MATERIAL CLEARANCES

If Not Using Mantel

Note: If using a mantel proceed to *If Using Mantel*. If not using a mantel, follow the information on this page.

You must have noncombustible material(s) above the fireplace opening. Noncombustible materials (such as slate, marble, tile, etc.) must be at least 1/2 inch thick. With sheet metal, you must have noncombustible material behind it. Noncombustible material must extend at least 8" up (for all models). If noncombustible material is less than 12", you must install the fireplace hood accessory. See Figure 5, page 10, for minimum clearances.

If Using Mantel

You must have noncombustible material(s) above the fireplace opening. Noncombustible materials (such as slate, marble, tile, etc.) must be at least 1/2 inch thick. With sheet metal, you must have noncombustible material behind it. Noncombustible material must extend at least 8 inches up). If noncombustible material is less than 12", you must install the fireplace hood accessory. Even if noncombustible material is more than 12", you may need the hood accessory to deflect heat away from your mantel shelf. See Figures 5, 6 and 7, page 10, for minimum clearances.

IMPORTANT: If you cannot meet these minimum clearances, you must operate heater with chimney flue damper open. Go to *Installing Damper Clamp Accessory for Vented Operation*, page 11.

INSTALLATION

Continued

Noncombustible Material Distance (A)	Requirements for Safe Installation
12" or more	Noncombustible Material OK.
Between 8" and 12"	Install fireplace hood accessory (GA6050, GA6052 or GA6053 see <i>Accessories</i> , page 27)
Less than 8"	Noncombustible materials must be extended to at least 8". See <i>Between 8" and 12"</i> above. If you cannot extend material, you must operate heater with flue damper open.

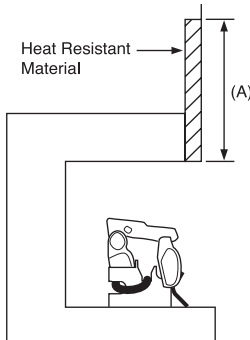


Figure 5 - Heat Resistant Material (Slate, Marble, Tile, etc.) Above Fireplace

MANTEL CLEARANCES

In addition to meeting noncombustible material clearances, you must also meet required clearances between fireplace opening and mantel shelf. If you do not meet the clearances listed below, you will need a hood.

Determining Minimum Mantel Clearance

If you meet minimum clearance between mantel shelf and top of fireplace opening, a hood is not required (see Figure 6).

Determining Minimum Mantel Clearance When Using a Hood

If minimum clearances in Figure 6 are not met, you must have a hood. When using a hood there are still certain minimum mantel clearances required. Follow minimum clearances shown in Figure 7 when using hood.

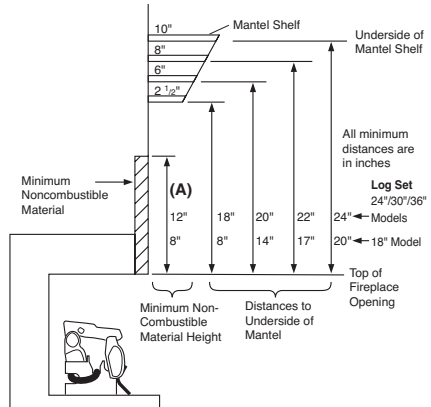


Figure 6 - Minimum Mantel Clearances Without Using Hood

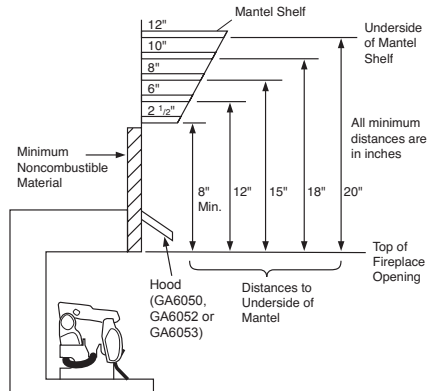


Figure 7 - Minimum Mantel Clearances When Using Hood

NOTICE: Surface temperatures of adjacent walls and mantels become hot during operation. Walls and mantels above the firebox may become hot to the touch. If installed properly, these temperatures meet the requirement of the national product standard. Follow all minimum clearances shown in this manual.

INSTALLATION

Continued

NOTICE: If your installation does not meet the minimum clearances shown, you must do one of the following:

- operate the logs only with the flue damper open
- raise the mantel to an acceptable height
- remove the mantel

FLOOR CLEARANCES

- A. If installing appliance on the floor level, you must maintain the minimum distance of 14" to combustibles (see Figure 8).
- B. If combustible materials are less than 14" to the fireplace, you must install appliance at least 5" above the combustible flooring (see Figure 9).

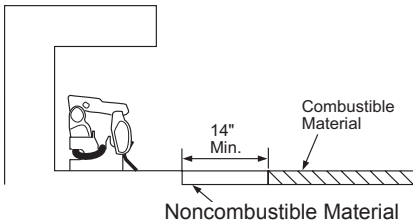


Figure 8 - Minimum Fireplace Clearances If Installed at Floor Level

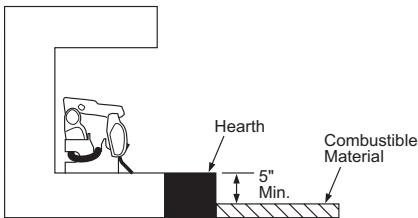


Figure 9 - Minimum Fireplace Clearances Above Combustible Flooring

INSTALLING DAMPER CLAMP ACCESSORY FOR VENTED OPERATION

Note: When used as a vented heater, appliance must be installed only in a solid-fuel burning fireplace with a working flue and constructed of noncombustible material.

If your heater is a manually-controlled model, you may use this heater as a vented product. There are three reasons for operating your heater in the vented mode.

1. The fireplace does not meet the clearance to combustibles requirements for vent-free operation.
2. State or local codes do not permit vent-free operation.
3. You prefer vented operation.

If reasons number 1 or 2 above apply to you, you must permanently open chimney flue damper. You must install the damper clamp accessory (to order, see *Accessories*, page 27). This will insure vented operation (see Figure 10). The damper clamp will keep damper open. Installation instructions are included with clamp accessory.

See chart below for minimum permanent flue opening you must provide. Attach damper clamp so the minimum permanent flue opening will be maintained at all times.

Area of Various Standard Round Flues	
Diameter (ins.)	Area (sq. ins.)
5"	20 sq. inches
6"	29 sq. inches
7"	39 sq. inches
8"	51 sq. inches

Chimney Height (ft.)	Minimum Permanent Flue Opening (sq. ins.)
6' to 15'	39 sq. inches
15' to 30'	29 sq. inches

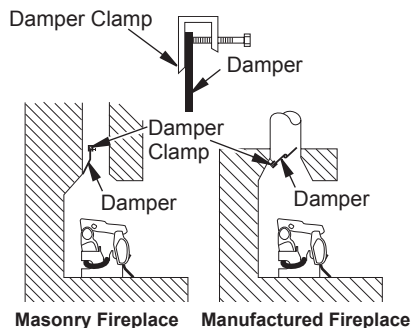


Figure 10 - Attaching Damper Clamp

INSTALLATION

Continued

INSTALLING HEATER BASE ASSEMBLY

⚠ WARNING: You must secure this heater to fireplace floor. If not, heater will move when you adjust controls. Moving heater may cause a gas leak or log misplacement.

⚠ WARNING: If installing in a sunken fireplace, special care is needed. You must raise the fireplace floor to allow access to heater control panel. This will insure adequate air flow and guard against sooting and controls being damaged. Raise fireplace floor with noncombustible material. Make sure material is secure.

⚠ CAUTION: Do not pick up heater base assembly by burners. This could damage heater. Only handle base assembly by grates.

IMPORTANT: Make sure the heater burners are level. If heater is not level, heater will not work properly. For thermostat models, avoid damage to thermostat bulb. Avoid nicks or sharp bends in thermostat bulb wire. Keep thermostat bulb in mounting bracket until ready to mount base to floor. See *Optional Positioning Of Thermostat Sensing Bulb*, page 25.

Installation Items Needed

- hardware package (provided with heater)
- approved flexible gas hose and fittings (not provided) (if allowed by local codes)
- sealant (resistant to propane/LP gas, not provided)
- electric drill with 3/16" drill bit (metal or masonry as applicable)
- flathead screwdriver
- pipe wrench

1. Apply pipe joint sealant lightly to male threads of gas fitting (not provided). Connect approved flexible gas hose to gas regulator of heater (see Figure 11). **IMPORTANT:** Hold gas regulator with wrench when connecting flexible gas hose.
2. Locate two masonry screws in hardware package.
3. Place heater base in fireplace.
4. Place logs in their proper position on heater base (see *Installing Logs*, page 15).
5. Center heater base and logs front-to-back and side-to-side in fireplace.
6. Carefully remove logs without moving heater base.
7. Mark screw locations through one hole on each side of the base (see Figure 12). If installing in a brick-bottom fireplace, mark screw locations in mortar joint of bricks.
8. Remove heater base from fireplace.
9. Drill holes at marked locations using 3/16" drill bit.
10. Attach base assembly to fireplace floor using two masonry screws (in hardware package).

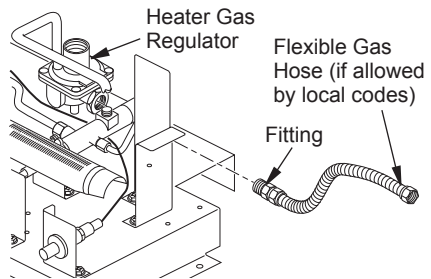


Figure 11 - Attaching Flexible Gas Hose to Heater Gas Regulator

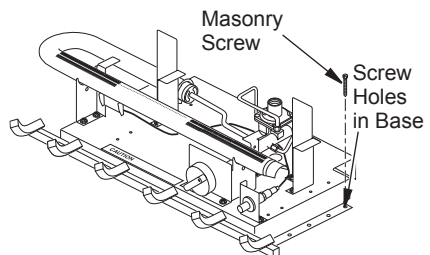


Figure 12 - Attaching Heater to Fireplace Floor

INSTALLATION

Continued

CONNECTING TO GAS SUPPLY

⚠ WARNING: This appliance requires a 1/2" NPT (National Pipe Thread) inlet connection to the pressure regulator.

⚠ WARNING: A qualified service person must connect heater to gas supply. Follow all local codes.

⚠ CAUTION: Never connect propane/LP fireplace directly to the propane/LP supply. This heater requires an external regulator (not supplied). Install the external regulator between the heater and propane/LP supply.

⚠ WARNING: Never connect natural gas fireplace to private (non-utility) gas wells. This gas is commonly known as wellhead gas.

Installation Items Needed

Before installing heater, make sure you have the items listed below.

- external regulator (supplied by installer)
- piping (check local codes)
- sealant (resistant to propane/LP gas)
- equipment shutoff valve *
- test gauge connection *
- sediment trap
- tee joint
- pipe wrench

* A CSA design-certified equipment shutoff valve with 1/8" NPT tap is an acceptable alternative to test gauge connection. Purchase the optional CSA design-certified equipment shutoff valve from your dealer. See *Accessories*, page 27.

For propane/LP units, the installer must supply an external regulator. The external regulator will reduce incoming gas pressure. You must reduce incoming gas pressure to between 11 and 14 inches of water. If you do not reduce incoming gas pressure, heater regulator damage could occur. Install external regulator with the vent pointing down

as shown in Figure 13. Pointing the vent down protects it from freezing rain or sleet.

⚠ CAUTION: Use only new, black iron or steel pipe. Internally-tinned copper tubing may be used in certain areas. Check your local codes. Use pipe of 1/2" diameter or greater to allow proper gas volume to heater. If pipe is too small, undue loss of volume will occur.

Installation must include an equipment shutoff valve, union and plugged 1/8" NPT tap. Locate NPT tap within reach for test gauge hook up. NPT tap must be upstream from heater (see Figure 14, page 14).

IMPORTANT: Install equipment shutoff valve in an accessible location. The equipment shutoff valve is for turning on or shutting off the gas to the appliance.

Check your building codes for any special requirements for locating equipment shutoff valve to fireplaces.

Apply pipe joint sealant lightly to male NPT threads. This will prevent excess sealant from going into pipe. Excess sealant in pipe could result in clogged heater valves.

⚠ WARNING: Use pipe joint sealant that is resistant to liquid petroleum (LP) gas.

We recommend that you install a sediment trap in supply line as shown in Figures 14, page 14. Locate sediment trap where it is within reach for cleaning. Install in piping system between fuel supply and heater. Locate sediment trap where trapped matter is not likely to freeze. A sediment trap traps moisture and contaminants. This keeps them from going into heater controls. If sediment trap is not installed or is installed wrong, heater may not run properly.

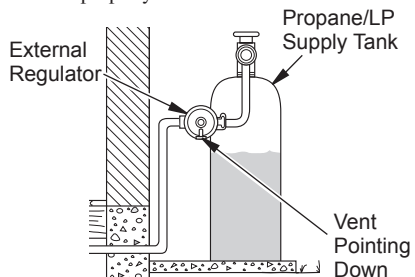


Figure 13 - External Regulator With Vent Pointing Down

INSTALLATION

Continued

⚠ CAUTION: Avoid damage to regulator. Hold gas regulator with wrench when connecting it to gas piping and/or fittings.

PROPANE/LP

From External Regulator (11" W.C.** to 14" W.C. Pressure)

NATURAL

From Gas Meter (5" W.C.** to 10.5" W.C. Pressure)

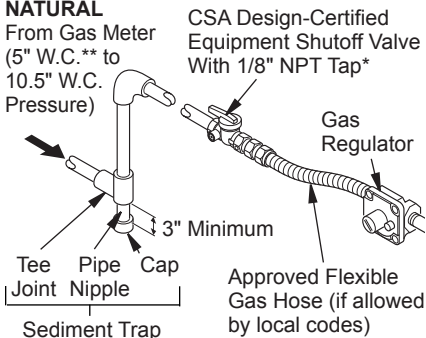


Figure 14 - Gas Connection

* Purchase the optional CSA design-certified equipment shutoff valve from your dealer. See *Accessories*, page 27.

** Minimum inlet pressure for purpose of input adjustment.

CHECKING GAS CONNECTIONS

⚠ WARNING: Test all gas piping and connections, internal and external to unit, for leaks after installing or servicing. Correct all leaks at once.

⚠ WARNING: Never use an open flame to check for a leak. Apply a noncorrosive leak detection fluid to all joints. Bubbles forming show a leak. Correct all leaks at once.

⚠ CAUTION: Make sure external regulator has been installed between propane/LP supply and heater. See guidelines under *Connecting to Gas Supply*, page 13.

PRESSURE TESTING GAS SUPPLY PIPING SYSTEM

Test Pressures In Excess Of 1/2 PSIG (3.5 kPa)

1. Disconnect appliance with its appliance main gas valve (control valve) and equipment shutoff valve from gas supply piping system. Pressures in excess of 1/2 psig will damage heater regulator.
2. Cap off open end of gas pipe where equipment shutoff valve was connected.
3. Pressurize supply piping system by either opening propane/LP supply tank valve for propane/LP gas or opening main gas valve located on or near gas meter for natural gas or using compressed air.
4. Check all joints of gas supply piping system. Apply noncorrosive leak detection fluid to all joints. Bubbles forming show a leak.
5. Correct all leaks at once.
6. Reconnect heater and equipment shutoff valve to gas supply. Check reconnected fittings for leaks.

Test Pressures Equal To or Less Than 1/2 PSIG (3.5 kPa)

1. Close equipment shutoff valve (see Figure 15).
2. Pressurize supply piping system by either opening propane/LP supply tank valve for propane/LP gas or opening main gas valve located on or near gas meter for natural gas or using compressed air.
3. Check all joints from gas meter to equipment shutoff valve for natural gas or propane/LP supply to equipment shutoff valve for propane/LP (see Figures 16 and 17, page 15). Apply noncorrosive leak detection fluid to all joints. Bubbles forming show a leak.
4. Correct all leaks at once.

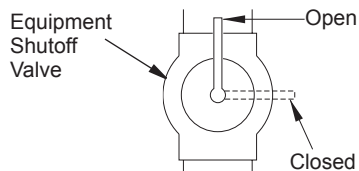


Figure 15 - Equipment Shutoff Valve

INSTALLATION

Continued

PRESSURE TESTING HEATER GAS CONNECTIONS

1. Open equipment shutoff valve (see Figure 15, page 14).
2. Open main gas valve located on or near gas meter for natural gas or open propane/LP supply tank valve.
3. Make sure control knob of heater is in the OFF position.
4. Check all joints from equipment shutoff valve to control valve (see Figures 16 and 17). Apply noncorrosive leak detection fluid to all joints. Bubbles forming show a leak.
5. Correct all leaks at once.
6. Light heater (see *Operating Heater*, page 16) depending on your model). Check all other internal joints for leaks.
7. Turn off heater (see *To Turn Off Gas to Appliance*, page 18 or 20, depending on your model).

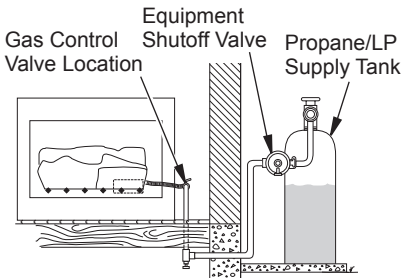


Figure 16 - Checking Gas Joints (Propane/LP only)

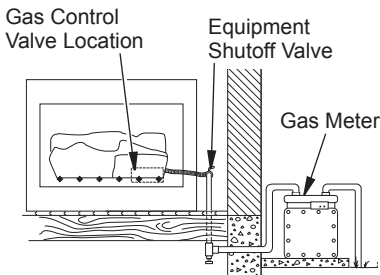


Figure 17 - Checking Gas Joints (Natural Gas Only)

INSTALLING LOGS

⚠ WARNING: Failure to position the parts in accordance with these diagrams or failure to use only parts specifically approved with this heater may result in property damage or personal injury.

⚠ CAUTION: After installation and periodically thereafter, check to ensure that no flame comes in contact with any log. With the heater set to HI, check to see if flames contact any log. If so, reposition logs according to the log installation instructions in this manual. Flames contacting logs will create soot.

It is very important to install the logs exactly as instructed. Do not modify logs. Only use logs supplied with heater.

Variable Manually-Controlled Models (LSL)

1. Place rear log onto rear brackets making sure brackets fit into recess on bottom of log (see Figure 18).
2. Place left front log on grate fingers as shown in Figure 19, page 16. Place right front log on grate fingers and on left front log (see Figure 19, page 16).
3. Slide control cover log into position between two front logs assuring the cover log seats into cutout section (see Figure 20, page 16).

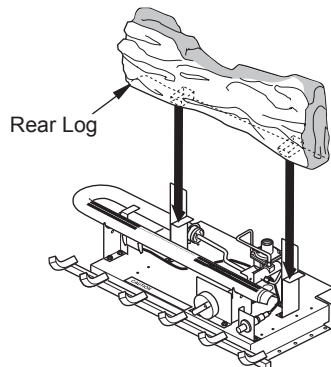


Figure 18 - Rear Log Placement (Variable Manually-Controlled Models)

INSTALLATION

Continued

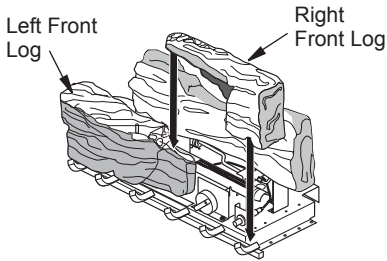


Figure 19 - Left and Right Front Log Placement (Variable Manually-Controlled Models)

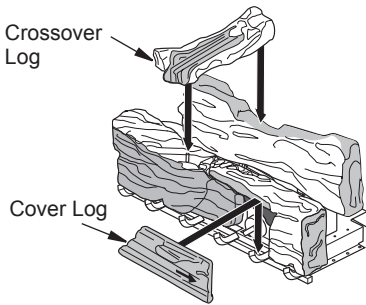


Figure 20 - Control Cover Log Placement (Variable Manually-Controlled Models)

Thermostat Models (CDL)

1. Place rear log on 2 pins on rear brackets (see Figure 21).
2. Place front log on grate fingers and over pins of rear log as shown in see Figure 21.
3. Place control cover log onto two pins on front log assuring the cover log seats into cutout section of front log (see Figure 22).
4. Place crossover log on pins on rear and middle log (see Figure 22).

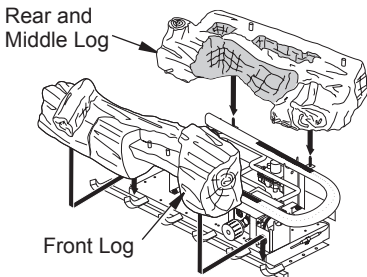


Figure 21 - Front and Rear Log Placement (Thermostat Models)

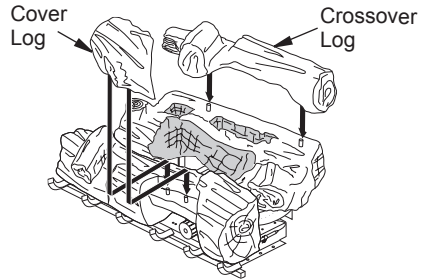


Figure 22 - Front Log Placement (Thermostat Models)

OPERATING HEATER

MANUALLY-CONTROLLED MODELS

**FOR YOUR SAFETY
READ BEFORE LIGHTING**

⚠ WARNING: If you do not follow these instructions exactly, a fire or explosion may result causing property damage, personal injury or loss of life.

- A. This appliance has a pilot which must be lighted by hand. When lighting the pilot, follow these instructions exactly.
- B. **BEFORE LIGHTING** smell all around the appliance area for gas. Be sure to smell next to the floor because some gas is heavier than air and will settle on the floor.

WHAT TO DO IF YOU SMELL GAS

- Do not try to light any appliance.
 - Do not touch any electric switch; do not use any phone in your building.
 - Immediately call your gas supplier from a neighbor's phone. Follow the gas supplier's instructions.
 - If you cannot reach your gas supplier, call the fire department.
- C. Use only your hand to push in or turn the gas control knob. Never use tools. If the knob will not push in or turn by hand, don't try to repair it, call a qualified service technician or gas supplier. Force or attempted repair may result in a fire or explosion.
 - D. Do not use this appliance if any part has been under water. Immediately call a qualified service technician to inspect the appliance and to replace any part of the control system and any gas control which has been under water.

OPERATING HEATER

Continued

LIGHTING INSTRUCTIONS


⚠ WARNING:


- If fireplace has glass doors, never operate this heater with glass doors closed. If you operate heater with doors closed, heat buildup inside fireplace will cause glass to burst. Make sure there are no obstructions across opening of fireplace.
- You must operate this heater with a fireplace screen in place. Make sure fireplace screen is closed before running heater.

NOTICE: During initial operation of new heater, burning logs will give off a paper-burning smell. Orange flame will also be present. Open damper or window to vent smell. This will only last a few hours.


Note: Home owners generally prefer to operate their heater with the chimney damper closed. This will put all the heat into the room. However, there may be times you will desire the full flames of the HI heat setting but will find the heat output excessive. You can open the chimney damper (if you have one) fully or partially to release some of the heat.

⚠ WARNING: Damper handle will be hot if heater has been running.

1. STOP! Read the safety information on page 16.
2. Remove control cover log (see Figure 23).
3. Make sure equipment shutoff valve is fully open.
4. Press in and turn control knob clockwise  to the OFF position.
5. Wait five (5) minutes to clear out any gas. Then smell for gas, including near the floor. If you smell gas, STOP! Follow "B" in the safety information, page 16. If you don't smell gas, go to the next step.

6. Slightly depress and turn control knob counterclockwise  to the PILOT position. Keep control knob pressed in for five (5) seconds (see Figure 23).

Note: You may be running this heater for the first time after hooking up to gas supply. If so, the control knob may need to be pressed in for 30 seconds or more. This will allow air to bleed from the gas system.

7. With control knob pressed in, press and release ignitor button. This will light pilot. The pilot is attached to the burner. If needed, keep pressing ignitor button until pilot lights. **Note:** If pilot does not light, contact a qualified service person or gas supplier for repairs. Until repairs are made, light pilot with match. To light pilot with match, see *Manual Lighting Procedure*, page 18.
8. Keep control knob pressed in for 30 seconds after lighting pilot. After 30 seconds, release control knob.
 - If control knob does not pop out when released, contact a qualified service person or gas supplier for repairs.
Note: If pilot goes out, repeat steps 3 through 7.
9. Slightly depress and turn control knob counterclockwise  to the HI position. The burner should light. Set control knob to any heat level between HI and LO.
10. Replace control cover log (see Figure 23).

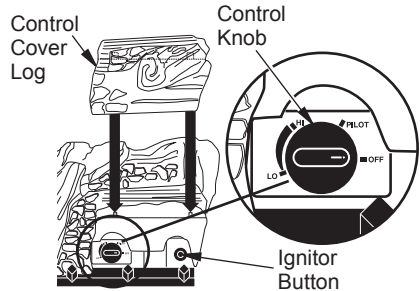
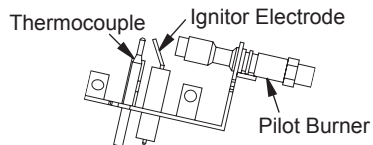


Figure 23 - Control Knob and Ignitor Button Location (Actual Logs May Vary)



(Note: Appearance of pilot assembly may vary by model.)

Figure 24 - Pilot

OPERATING HEATER

Continued

VARIABLE CONTROL OPERATION




The variable control valve can be set to any heat setting and flame height desired, by simply turning the control knob until that setting is attained. Even the lowest setting provides realistic, dancing yellow flames. Selecting higher settings produces greater heat output. This results in increased heating comfort.

⚠ WARNING: Do not operate heater between PILOT and HI positions.



⚠ CAUTION: Do not try to adjust heating levels by using the equipment shutoff valve.

TO TURN OFF GAS TO APPLIANCE

Shutting Off Heater

1. Remove control cover log (see Figure 23, page 17).
2. Press in and turn control knob clockwise  to the HI position.
3. Turn the control knob clockwise  to the PILOT position.
4. Press in control knob and turn clockwise  to the OFF position.
5. Replace control cover log (see Figure 23, page 17).

Shutting Off Burners Only (pilot stays lit)

1. Remove control cover log (see Figure 23, page 17).
2. Turn the control knob clockwise  to the HI position.
3. Press in and turn control knob clockwise  to the PILOT position.
4. Replace control cover log (see Figure 23, page 17).

MANUAL LIGHTING PROCEDURE

1. Follow steps 1 through 6 under *Lighting Instructions*, page 17.
2. Depress control knob and light pilot with match.
3. Keep control knob pressed in for 30 seconds after lighting pilot. After 30 seconds, release control knob. Now follow steps 9 and 10, page 17.

THERMOSTAT MODELS

FOR YOUR SAFETY READ BEFORE LIGHTING

⚠ WARNING: If you do not follow these instructions exactly, a fire or explosion may result causing property damage, personal injury or loss of life.

- A. This appliance has a pilot which must be lighted by hand. When lighting the pilot, follow these instructions exactly.
- B. **BEFORE LIGHTING** smell all around the appliance area for gas. Be sure to smell next to the floor because some gas is heavier than air and will settle on the floor.

WHAT TO DO IF YOU SMELL GAS

- Do not try to light any appliance.
 - Do not touch any electric switch; do not use any phone in your building.
 - Immediately call your gas supplier from a neighbor's phone. Follow the gas supplier's instructions.
 - If you cannot reach your gas supplier, call the fire department.
- C. Use only your hand to push in or turn the gas control knob. Never use tools. If the knob will not push in or turn by hand, don't try to repair it, call a qualified service technician or gas supplier. Force or attempted repair may result in a fire or explosion.
 - D. Do not use this appliance if any part has been under water. Immediately call a qualified service technician to inspect the appliance and to replace any part of the control system and any gas control which has been under water.

OPERATING HEATER

Continued

LIGHTING INSTRUCTIONS

⚠ WARNING:

- If fireplace has glass doors, never operate this heater with glass doors closed. If you operate heater with doors closed, heat buildup inside fireplace will cause glass to burst. Make sure there are no obstructions across opening of fireplace.
- You must operate this heater with a fireplace screen in place. Make sure fireplace screen is closed before running heater.

NOTICE: During initial operation of new heater, burning logs will give off a paper-burning smell. Orange flame will also be present. Open damper or window to vent smell. This will only last a few hours.

Note: Home owners generally prefer to operate their heater with the chimney damper closed. This will put all the heat into the room. However, there may be times you will desire the full flames of the HI heat setting but will find the heat output excessive. You can open the chimney damper (if you have one) fully or partially to release some of the heat.

⚠ WARNING: Damper handle will be hot if heater has been running.

1. STOP! Read the safety information in column 2, page 18.
2. Make sure equipment shutoff valve is fully open.
3. Turn control knob clockwise ↻ to the OFF position.
4. Wait five (5) minutes to clear out any gas. Then smell for gas, including near the floor. If you smell gas, STOP! Follow "B" in the safety information in column 2, page 18. If you don't smell gas, go to the next step.

5. Turn control knob counterclockwise ↻ to the PILOT position. Press in control knob for five (5) seconds (see Figure 25).

Note: You may be running this heater for the first time after hooking up to gas supply. If so, the control knob may need to be pressed in for 30 seconds or more. This will allow air to bleed from the gas system.

- If control knob does not pop out when released, contact a qualified service person or gas supplier for repairs.
6. With control knob pressed in, press and release ignitor button. This will light pilot. The pilot is attached to the front burner. If needed, keep pressing ignitor button until pilot lights.

Note: If pilot does not stay lit, contact a qualified service person or gas supplier for repairs. Until repairs are made, light pilot with match. To light pilot with match, see *Manual Lighting Procedure*, page 20.

7. Keep control knob pressed in for 30 seconds after lighting pilot. After 30 seconds, release control knob.

Note: If pilot goes out, repeat steps 3 through 7. This heater has a safety interlock system. Wait one (1) minute for system to reset before lighting pilot again.

8. Turn control knob counterclockwise ↻ to desired heating level. The burners should light. Set control knob to any heat level between HI and LO.

⚠ CAUTION: Do not try to adjust heating levels by using the equipment shutoff valve.

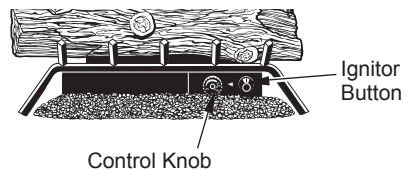


Figure 25 - Control Knob and Ignitor Button Location

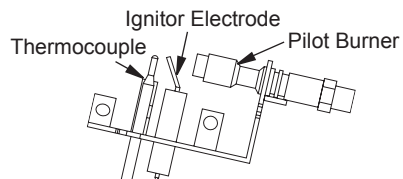



Figure 26 - Pilot

OPERATING HEATER


Continued

TO TURN OFF GAS TO APPLIANCE

Shutting Off Heater

Turn control knob clockwise  to the OFF position.

Shutting Off Burners Only (pilot stays lit)

Turn control knob clockwise  to the PILOT position.

THERMOSTAT CONTROL OPERATION

The thermostat control knob can be set to any comfort level between HI and LO. The thermostat will gradually modulate the heat output and flame height from higher to lower settings or pilot, in order to maintain the comfort level you select. The ideal comfort setting will vary by household depending upon the amount of space to be heated, the output of the central heating system, etc.

Note: Selecting the HI setting with the control knob will cause the burners to remain fully on, without modulating down in most cases.

MANUAL LIGHTING PROCEDURE

1. Follow steps 1 through 5 under *Lighting Instructions*, page 19.
2. Depress control knob and light pilot with match.
3. Keep control knob pressed in for 30 seconds after lighting pilot. After 30 seconds, release control knob. Now follow step 8 under *Lighting Instructions*, page 19.

INSPECTING BURNERS

Check pilot flame pattern and burner flame patterns often.

PILOT FLAME PATTERN

Figure 27 shows a correct pilot flame pattern. Figure 28 shows an incorrect pilot flame pattern. The incorrect pilot flame is not touching the thermocouple. This will cause the thermocouple to cool. When the thermocouple cools, the heater will shut down.

If pilot flame pattern is incorrect, as shown in Figure 28

- turn heater off (see *To Turn Off Gas to Appliance*, page 18 [Manually-Controlled Models] or page 20 [Thermostatically-Controlled Models])
- see *Troubleshooting*, page 22

Note: The pilot flame on natural gas units will have a slight curve, but flame should be blue and have no yellow or orange color.

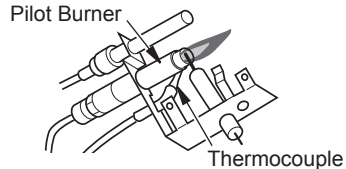


Figure 27 - Correct Pilot Flame Pattern
(Your pilot may vary from pilots shown)

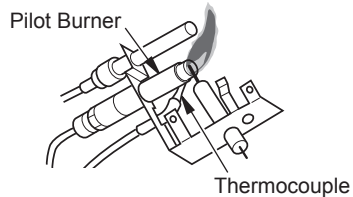


Figure 28 - Incorrect Pilot Flame Pattern
(Your pilot may vary from pilots shown)

BURNER PRIMARY AIR HOLES

Air is drawn into the burner through the holes in the fitting at the burner entrance. These holes may become blocked with dust or lint. Periodically inspect these holes for any blockage and clean if needed. Blocked air holes will create soot.

MAIN BURNER

Periodically inspect all burner flame holes with the heater running. All slotted burner flame holes should be open with yellow flame present. All round burner flame holes should be open with a small blue flame present. Some burner flame holes may become blocked by debris or rust, with no flame present. If so, turn off heater and let cool. Remove blockage. Blocked burner flame holes will create soot.

CLEANING AND MAINTENANCE

⚠ WARNING: Turn off heater and let cool before cleaning.

⚠ CAUTION: You must keep control areas, burners and circulating air passageways of heater clean. Inspect these areas of heater before each use. Have heater inspected yearly by a qualified service person. Heater may need more frequent cleaning due to excessive lint from carpeting, pet hair, bedding material, etc.

⚠ WARNING: Failure to keep the primary air opening(s) of the burner(s) clean may result in sooting and property damage.

BURNER INJECTOR HOLDER AND PILOT AIR INLET HOLE

The primary air inlet holes allow the proper amount of air to mix with the gas. This provides a clean burning flame. Keep these holes clear of dust, dirt, lint and pet hair. Clean these air inlet holes prior to each heating season. Blocked air holes will create soot. We recommend that you clean the unit every three months during operation and have heater inspected yearly by a qualified service person.

We also recommend that you keep the burner tube and pilot assembly clean and free of dust and dirt. To clean these parts we recommend using compressed air no greater than 30 PSI. Your local computer store, hardware store or home center may carry compressed air in a can. You can use a vacuum cleaner in the blow position. If using compressed air in a can, please follow the directions on the can. If you don't follow directions on the can, you could damage the pilot assembly.

1. Remove control cover log and front log.
2. Shut off the unit, including the pilot. Allow the unit to cool for at least thirty minutes.
3. Inspect burner, pilot and primary air inlet holes on injector holder for dust and dirt (see Figures 29 and 30).

4. Blow air through the ports/slots and holes in the burner.
5. Check the injector holder located at the end of the burner tube again. Remove any large particles of dust, dirt, lint or pet hair with a soft cloth or vacuum cleaner nozzle.
6. Blow air into the primary air holes on the injector holder.
7. In case any large clumps of dust have now been pushed into the burner repeat steps 3 and 4.
8. Replace front log and control cover log (see *Installing Logs*, page 15).

Clean the pilot assembly also. A yellow tip on the pilot flame indicates dust and dirt in the pilot assembly. There is a small pilot air inlet hole about two inches from where the pilot flame comes out of the pilot assembly (see Figure 30). With the unit off, lightly blow air through the air inlet hole. You may blow through a drinking straw if compressed air is not available.

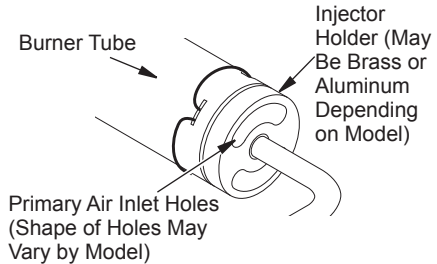


Figure 29 - Injector Holder On Outlet Burner Tube

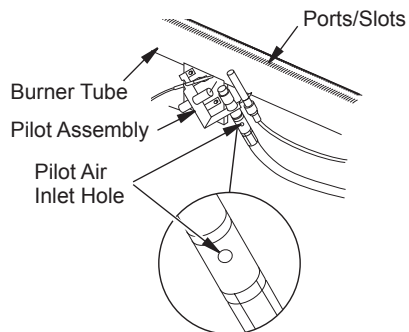


Figure 30 - Pilot Inlet Air Hole

LOGS

- If you remove logs for cleaning, refer to *Installing Logs*, page 15, to properly replace logs.
- Replace log(s) if broken or chipped (dime-sized or larger).

TROUBLESHOOTING

⚠ WARNING: Turn off heater and let cool before servicing. Only a qualified service person should service and repair heater.

⚠ CAUTION: Never use a wire, needle or similar object to clean ODS/pilot. This can damage ODS/pilot unit.

Note: All troubleshooting items are listed in order of operation.

OBSERVED PROBLEM	POSSIBLE CAUSE	REMEDY
When ignitor button is pressed, there is no spark at ODS/pilot	<ol style="list-style-type: none"> 1. Ignitor electrode not connected to ignitor cable 2. Ignitor cable pinched or wet 3. Piezo ignitor nut is loose 4. Broken ignitor cable 5. Bad piezo ignitor 6. Ignitor electrode positioned wrong 7. Ignitor electrode broken 	<ol style="list-style-type: none"> 1. Reconnect ignitor cable 2. Free ignitor cable if pinched by any metal or tubing. Keep ignitor cable dry 3. Tighten nut holding piezo ignitor to base panel of log set. Nut is located behind base panel 4. Replace ignitor cable 5. Replace piezo ignitor 6. Replace pilot assembly 7. Replace pilot assembly
When ignitor button is pressed, there is spark at ODS/pilot but no ignition	<ol style="list-style-type: none"> 1. Gas supply turned off or equipment shutoff valve closed 2. Control knob not in PILOT position 3. Control knob not pressed in while in PILOT position 4. Air in gas lines when installed 5. Depleted gas supply (propane/LP only) 6. ODS/pilot is clogged 7. Gas regulator setting not correct 	<ol style="list-style-type: none"> 1. Turn on gas supply or open equipment shutoff valve 2. Turn control knob to PILOT position 3. Press in control knob while in PILOT position 4. Continue holding down control knob. Repeat igniting operation until air is removed 5. Contact local propane/LP gas company 6. Clean ODS/pilot (see <i>Cleaning and Maintenance</i>, page 21) or replace ODS/pilot assembly 7. Replace gas regulator
ODS/pilot lights but flame goes out when control knob is released	<ol style="list-style-type: none"> 1. Control knob not fully pressed in 2. Control knob not pressed in long enough 3. Safety interlock system has been triggered 4. Equipment shutoff valve not fully open 5. Pilot flame not touching thermocouple, which allows thermocouple to cool, causing pilot flame to go out. This problem could be caused by one or both of the following: A) Low gas pressure B) Dirty or partially clogged ODS/pilot 6. Thermocouple connection loose at control valve 7. Thermocouple damaged 8. Control valve damaged 	<ol style="list-style-type: none"> 1. Press in control knob fully 2. After ODS/pilot lights, keep control knob pressed in 30 seconds 3. Wait one minute for safety interlock system to reset. Repeat ignition operation 4. Fully open equipment shutoff valve 5. A) Contact local natural or propane/LP gas company B) Clean ODS/pilot (see <i>Cleaning and Maintenance</i>, page 21) or replace ODS/pilot assembly 6. Hand tighten until snug, then tighten 1/4 turn more 7. Replace pilot assembly 8. Replace control valve

TROUBLESHOOTING

Continued

OBSERVED PROBLEM	POSSIBLE CAUSE	REMEDY
Burner does not light after ODS/pilot is lit	<ol style="list-style-type: none"> Inlet gas pressure is too low Burner orifice(s) clogged 	<ol style="list-style-type: none"> Contact local natural or propane/LP gas company Clean burner(s) (see <i>Cleaning and Maintenance</i>, page 21) or replace burner orifice(s)
Delayed ignition of one or both burners	<ol style="list-style-type: none"> Manifold pressure is too low Burner orifice(s) clogged 	<ol style="list-style-type: none"> Contact local natural or propane/LP gas company Clean burner(s) (see <i>Cleaning and Maintenance</i>, page 21) or replace burner orifice(s)
Burner backfiring during combustion	<ol style="list-style-type: none"> Burner orifice is clogged or damaged Damaged burner Gas regulator defective 	<ol style="list-style-type: none"> Clean burner (see <i>Cleaning and Maintenance</i>, page 21) or replace burner orifice Replace damaged burner Replace gas regulator
Slight smoke or odor during initial operation	<ol style="list-style-type: none"> Not enough air Gas regulator defective Residues from manufacturing processes and logs curing 	<ol style="list-style-type: none"> Check burner for dirt and debris. If found, clean burner (see <i>Cleaning and Maintenance</i>, page 21) Replace gas control Problem will stop after a few hours of operation
Heater produces a whistling noise when burners are lit	<ol style="list-style-type: none"> Turning control knob to HI position when burners are cold Air in gas line Air passageways on heater blocked Dirty or partially clogged burner orifice(s) 	<ol style="list-style-type: none"> Turn control knob to LO position and let warm up for a minute Operate burners until air is removed from line. Have gas line checked by local natural or propane/LP gas company Observe minimum installation clearances (see page 9) Clean burners (see <i>Cleaning and Maintenance</i>, page 21) or replace burner orifice
White powder residue forming within burner box or on adjacent walls or furniture	<ol style="list-style-type: none"> When heated, vapors from furniture polish, wax, carpet cleaners, etc. may turn into white powder residue 	<ol style="list-style-type: none"> Turn heater off when using furniture polish, wax, carpet cleaners or similar products
Moisture/condensation noticed on windows	<ol style="list-style-type: none"> Not enough combustion/ventilation air 	<ol style="list-style-type: none"> Refer to <i>Air for Combustion and Ventilation</i> requirements (page 5)
Dark residue on logs inside of their fireplace <i>Note:</i> After removing all causes of residue deposits, completely clean fireplace and appliance off residue before reusing appliance	<ol style="list-style-type: none"> Improper log placement Drafts or other air currents affecting flame pattern Air holes at burner inlet blocked Burner flame holes blocked 	<ol style="list-style-type: none"> Properly locate logs (see <i>Installing Logs</i>, page 15) Eliminate source of drafts around heater Clean out air holes at burner inlet. Periodically repeat as needed Remove blockage

TROUBLESHOOTING

Continued



WARNING: If you smell gas

- Shut off gas supply.
- Do not try to light any appliance.
- Do not touch any electrical switch; do not use any phone in your building.
- Immediately call your gas supplier from a neighbor's phone. Follow the gas supplier's instructions.
- If you cannot reach your gas supplier, call the fire department.

IMPORTANT: Operating heater where impurities in air exist may create odors. Cleaning supplies, paint, paint remover, cigarette smoke, cements and glues, new carpet or textiles, etc., create fumes. These fumes may mix with combustion air and create odors. These odors will disappear over time.

OBSERVED PROBLEM	POSSIBLE CAUSE	REMEDY
Heater produces a clicking/ticking noise just after burners are lit or shut off	1. Metal expanding while heating or contracting while cooling	1. This is common with most heaters. If noise is excessive, contact qualified service person
Heater produces unwanted odors	1. Heater burning vapors from paint, hair spray, glues, cleaners, chemicals, new carpet, etc. (See <i>IMPORTANT</i> statement above) 2. Low fuel supply (propane/LP only) 3. Gas leak. See Warning statement at top of page	1. Open window to ventilate room. Stop using odor causing products while heater is running 2. Refill supply tank (propane/LP only) 3. Locate and correct all leaks (see <i>Checking Gas Connections</i> , page 14)
Heater shuts off in use (ODS operates)	1. Not enough fresh air is available 2. Low line pressure 3. ODS/pilot is partially clogged	1. Open window and/or door for ventilation 2. Contact local natural or propane/LP gas company 3. Clean ODS/pilot (see <i>Cleaning and Maintenance</i> , page 21)
Gas odor even when control knob is in OFF position	1. Gas leak. See Warning statement at top of page 2. Control valve defective	1. Locate and correct all leaks (see <i>Checking Gas Connections</i> , page 14) 2. Replace control valve
Gas odor during combustion	1. Foreign matter between control valve and burner 2. Gas leak. See Warning statement at top of page	1. Take apart gas tubing and remove foreign matter 2. Locate and correct all leaks (see <i>Checking Gas Connections</i> , page 14)
Logs set cycles to pilot, but room temperature drops to a lower than ideal level before log set comes back on	1. Thermostat sensing bulb needs to be repositioned	1. Reposition thermostat sensing bulb (see instructions for <i>Optional Positioning of Thermostat Sensing Bulb</i> , page 25)

OPTIONAL POSITIONING OF THERMOSTAT SENSING BULB

For Masonry and Factory-Built Metal Fireplace

If your log set cycles to pilot, but the room temperature drops to a lower than ideal comfort level before the log set comes back on, you may want to reposition the thermostat sensing bulb.

The thermostat sensing bulb is located near the gas valve assembly on the mounting bracket. This location allows the thermostat to keep the room temperature at an ideal comfort level for most fireplace applications. For positioning the thermostat sensing bulb elsewhere, an adhesive-backed mounting clip is available (see Figure 31).

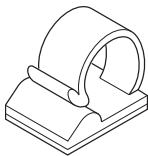
Tools needed: 1/4" hex driver or socket

1. Remove logs. Locate the gas valve assembly and thermostat sensing bulb (see Figure 32).
2. With 1/4" hex driver or socket, loosen the thermostat screw. Carefully slide the thermostat sensing bulb out of the retaining clamp (see Figure 33).

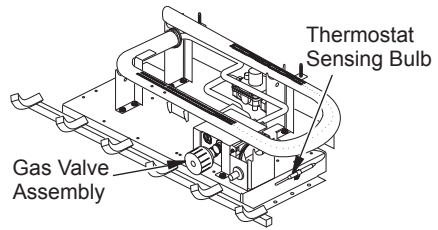
Note: Do not remove the screw. Make sure you tighten the screw after removing the thermostat sensing bulb.

IMPORTANT: Do not force or bend the thermostat sensing bulb or capillary.

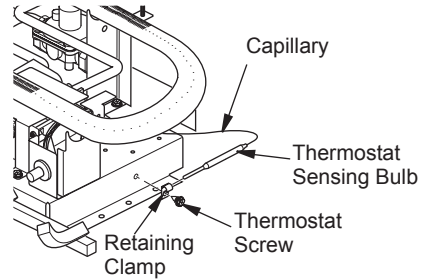
3. The thermostat sensing bulb may be located to the lower right front side of fireplace. Determine location of sensing bulb, but do not mount sensing bulb until step 5. If you have a masonry fireplace, see Figure 34 for location. If you have a factory-built metal fireplace, see Figure 35 for location. If your fireplace has glass doors, position sensing bulb directly behind door gap on right bottom side (see Figure 36).



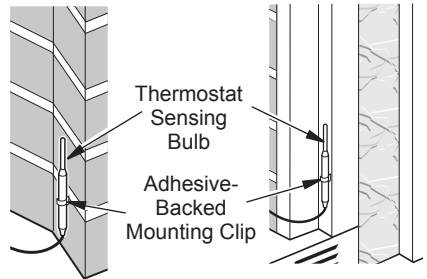
**Figure 31- Adhesive-backed Mounting
Clip**



**Figure 32 - Location of Gas Valve
Assembly and Thermostat Sensing Bulb**

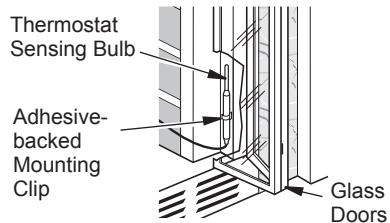


**Figure 33 - Removing Thermostat
Sensing Bulb**



**Figure 34 - Locating
Thermostat
Sensing Bulb on
Masonry Fireplace**

**Figure 35 - Locating
Thermostat Sensing
Bulb on Factory-
built Metal Fireplace**



**Figure 36 - Installing Thermostat Sensing
Bulb behind Glass Doors**

OPTIONAL POSITIONING OF THERMOSTAT SENSING BULB

Continued

- The mounting clip must be a minimum of 3" from bottom of fireplace to prevent crimping of capillary. Once you have decided on a location, clean the area thoroughly. Remove the paper backing from the adhesive on back of mounting clip. Press the clip into the new location so that the thermostat sensing bulb will be positioned vertically with the capillary at the bottom (see Figure 37). Slide the thermostat sensing bulb into the clip.

IMPORTANT: Do not crimp capillary.

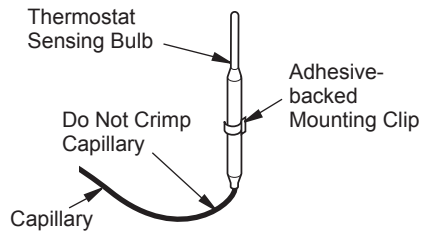


Figure 37 - Positioning the Thermostat Sensing Bulb in the Vertical Position with the Capillary at the Bottom

SPECIFICATIONS

Echo Valley Oak Log Variable Manually-Controlled

Btu (Variable)	16,000/31,500
Type Gas	Propane/LP - Natural
Ignition	Piezo
Manifold Pressure	8.0" W.C. - 3.5" W.C.
Inlet Gas Pressure (in. of water)	
Maximum	14" - 10.5"
Minimum*	11" - 5"
Shipping Weight	38 lbs.
* For purpose of input adjustment	

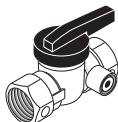
Meadowbrook Oak Log Thermostatically-Controlled

Btu (Variable)	26,000/39,000
Type Gas	Propane/LP - Natural
Ignition	Piezo
Manifold Pressure	8.0" W.C. - 3.5" W.C.
Inlet Gas Pressure (in. of water)	
Maximum	14" - 10.5"
Minimum*	11" - 5"
Shipping Weight	28 lbs.
* For purpose of input adjustment	

ACCESSORIES

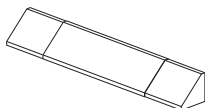
NOTICE: All accessories may not be available for all fireplace models.

Purchase these heater accessories from your local dealer. If they can not supply these accessories, call DESA Heating Products at 1-866-672-6040 for referral information. You can also write to the address listed on the back page of this manual.



EQUIPMENT SHUTOFF VALVE GA5010

For all models. Equipment shutoff valve with 1/8" NPT tap. Fits 1/2" NPT pipe.



FIREPLACE HOOD

Black - GA6050

Brass - GA6052

Antique Brass - GA6053

For all models. Helps deflect heat away from mantel or wall above fireplace. Fits openings 28" to 48" wide.

DAMPER CLAMP - GA6080

(Not Shown)

For all models. Permanently opens chimney flue damper for vented operation.

LAVA ROCK - GA6060

(Not Shown)

For all models. Order when additional rock is desired. (1.8 lb. bag)

CLEANING KIT - GCK

(Not Shown)

For all models. Your vent-free gas appliance requires regular cleaning and maintenance to prevent performance problems. This kit gives you the tools and instructions to make it easy to clean all critical areas of your appliance.

INFORMATION VIDEO - 108917-01

For all models. A care and maintenance video is available by calling 1-866-672-6040. You may also email your request to productsupport@desaint.com.

SERVICE HINTS

When Gas Pressure Is Too Low

- pilot will not stay lit
- burners will have delayed ignition
- heater will not produce specified heat
- for propane/LP units, propane/LP gas supply may be low

You may feel your gas pressure is too low. If so, contact your local propane/LP or natural gas supplier.

TECHNICAL SERVICE

You may have further questions about installation, operation or troubleshooting. If so, contact DESA Heating Products' Technical Service Department at 1-866-672-6040. When calling please have your model and serial numbers of your heater ready.

You can also visit DESA Heating Products' technical services web site at www.desatech.com.

REPLACEMENT PARTS

Note: Use only original replacement parts. This will protect your warranty coverage for parts replaced under warranty.

PARTS UNDER WARRANTY

Contact authorized dealers of this product. If they can't supply original replacement part(s), call DESA Heating Products' Technical Service Department at 1-866-672-6040.

When calling DESA Heating Products, have ready

- your name
- your address
- model and serial numbers of your heater
- how heater was malfunctioning
- type of gas used (propane/LP or natural gas)
- purchase date

Usually, we will ask you to return the part to the factory.

PARTS NOT UNDER WARRANTY

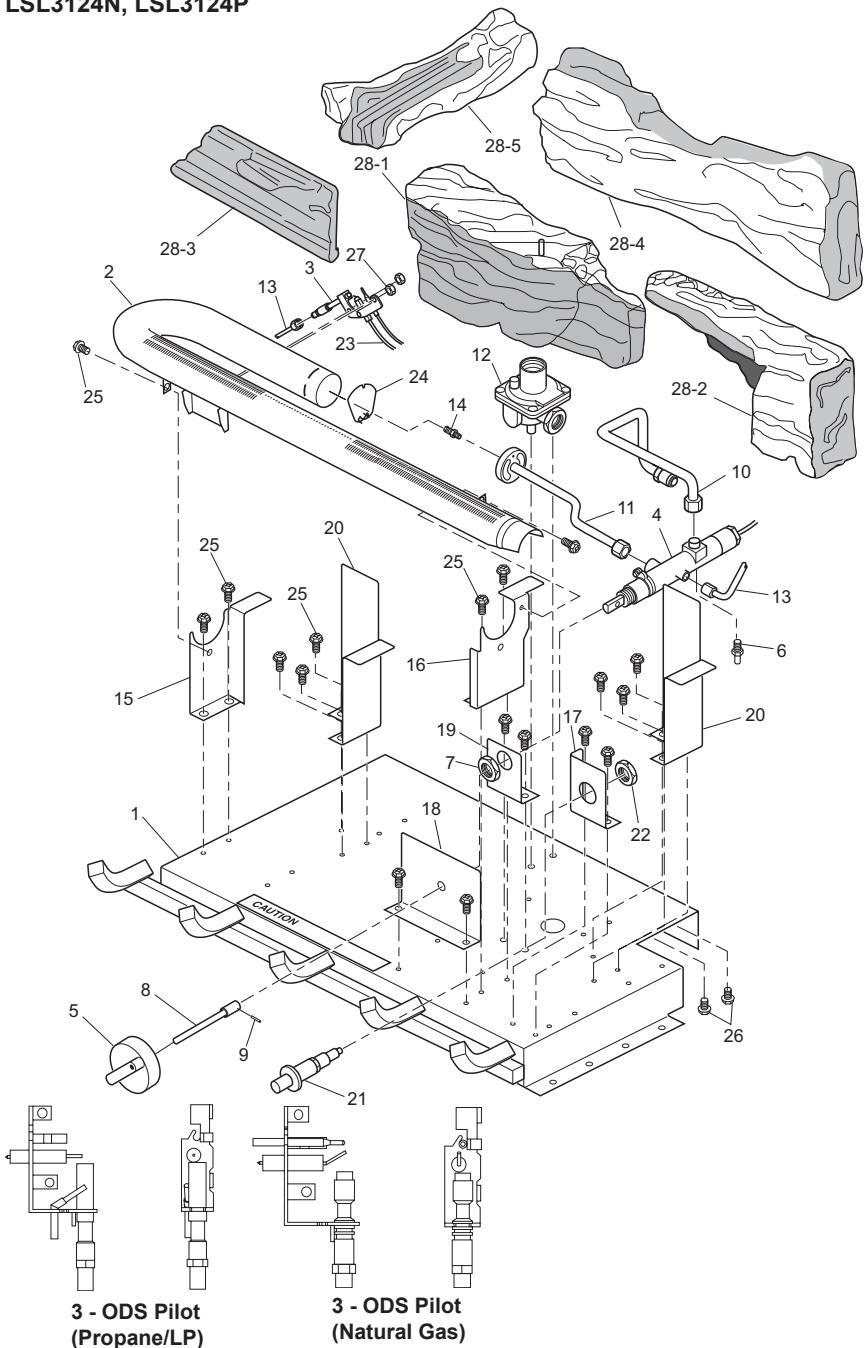
Contact authorized dealers of this product. If they can't supply original replacement part(s), call DESA Heating Products at 1-866-672-6040 for referral information.

When calling DESA Heating Products, have ready

- model number of your heater
- the replacement part number

ILLUSTRATED PARTS BREAKDOWN

VARIABLE MANUALLY- CONTROLLED ECHO VALLEY OAK LOG MODELS
LSL3124N, LSL3124P



PARTS LIST

VARIABLE MANUALLY-CONTROLLED ECHO VALLEY OAK LOG MODELS

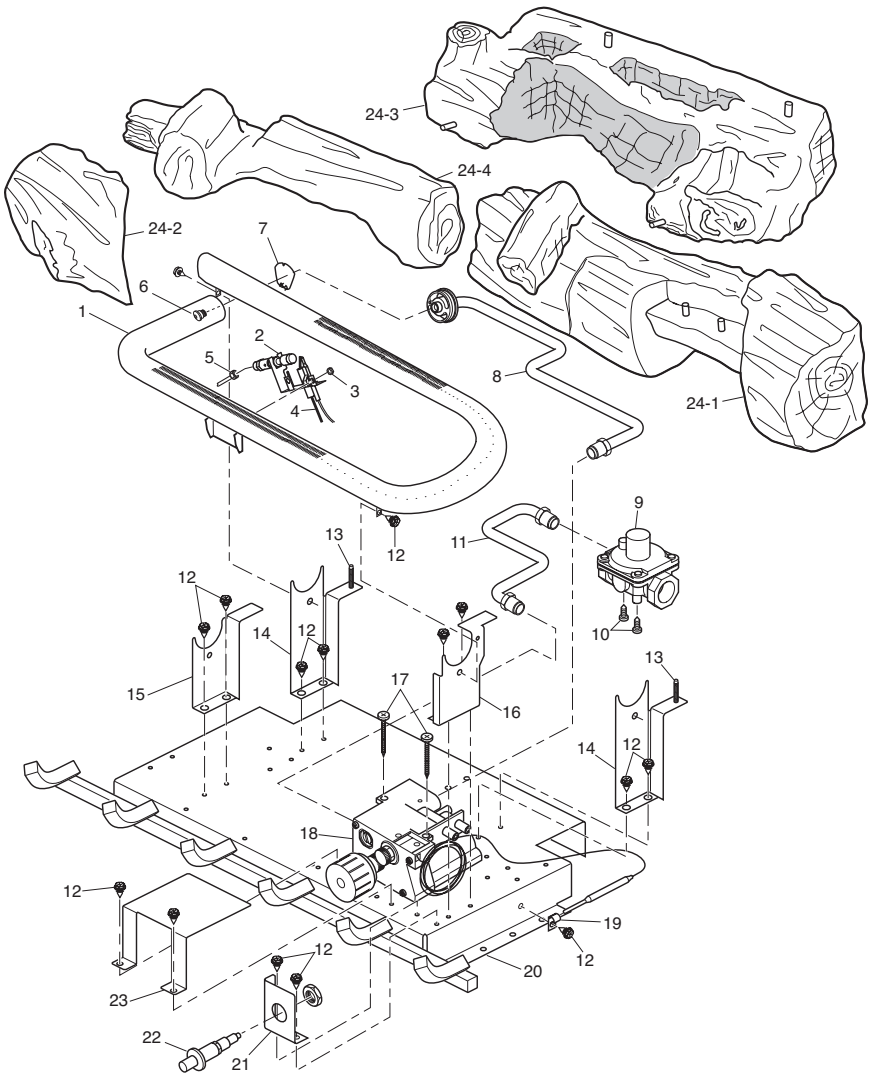
This list contains replaceable parts used in your heater. When ordering parts, follow the instructions listed under *Replacement Parts* on page 27 of this manual.

KEY NO.	PART NUMBER FOR		DESCRIPTION	QTY.
	LSL3124P	LSL3124N		
1	**	**	ASM, Low Profile Base, Painted	1
2	102773-01	102773-01	Single Burner, 24"	1
3	104286-01	—	ODS Pilot, Propane/LP Gas	1
	—	104285-01	ODS Pilot, Natural Gas	1
4	102568-08	—	Control Valve, Propane/LP Gas	1
	—	102568-07	Control Valve, Natural Gas	1
5	098354-01	098354-01	Control Knob	1
6	098276-01	098276-01	Plug, 1/8" NPT Hex Head	1
7	098508-01	098508-01	Valve Retainer Nut	1
8	098462-03	098462-03	Control Rod	1
9	098325-01	098325-01	Roll Pin	1
10	110801-01	110801-01	Inlet Tube	1
11	110802-06	111195-01	Outlet Tube	1
12	098867-10	—	Gas Regulator, Propane/LP Gas	1
	—	098867-14	Gas Regulator, Natural Gas	1
13	099387-08	099387-08	Pilot Tube	1
14	099056-31	099056-26	Injector	1
15	110790-01	110790-01	Left Front Burner Bracket	1
16	110790-02	110790-02	Right Front Burner Bracket	1
17	110793-01	110793-01	Piezo Bracket	1
18	110817-01	110817-01	Control Rod Bracket	1
19	110791-01	110791-01	Manual Valve Bracket	1
20	110902-01	110902-01	Log Support Bracket	2
21	102445-01	102445-01	Piezo Ignitor	1
22	102334-01	102334-01	Palnut Fastener	1
23	098271-10	098271-10	Ignitor Cable	1
24	111124-01	111124-01	Burner Retainer Spring	1
25	M11084-26	M11084-26	Screw, HWH AB 10-16 x .38	18
26	M11084-38	M11084-38	Screw, Hex Head Tpg 8-18 x .38	2
27	098249-01	098249-01	O.D.S. Nut	2
28-1	111501-01	111501-01	Left Front Log	1
28-2	111501-02	111501-02	Right Front Log	1
28-3	111501-03	111501-03	Control Cover Log	1
28-4	111501-04	111501-04	Back Log	1
28-5	111501-05	111501-05	Left Crossover Log	1
PARTS AVAILABLE — NOT SHOWN				
	100563-01	100563-01	Warning Plate	1
	101055-02	101055-02	Lighting Instruction Plate	1
	GA6060	GA6060	Lava Rock	1
	101137-02	101137-02	Hardware Kit	1

**Not a field replaceable part.

ILLUSTRATED PARTS BREAKDOWN

THERMOSTATICALLY- CONTROLLED MEADOWBROOK OAK LOG MODELS
CDL3924NT, CDL3924PT



PARTS LIST

THERMOSTATICALLY- CONTROLLED MEADOWBROOK OAK LOG

This list contains replaceable parts used in your heater. When ordering parts, follow the instructions listed under *Replacement Parts* on page 27 of this manual.

KEY NO.	PART NUMBER		DESCRIPTION	QTY.
	CDL3924NT	CDL3924PT		
1	102772-01	102772-01	Burner	1
2	104285-01	104286-01	ODS Pilot	1
3	098249-01	098249-01	ODS Nut	2
4	098271-10	098271-10	Ignitor Cable	1
5	099387-09	099387-09	Pilot Tube	1
6	099056-16	099056-17	Injector	1
7	111124-01	111124-01	Burner Retainer Spring	1
8	111195-04	_____	Outlet Tube Service Kit	1
	_____	110802-03	Outlet Tube	1
9	098867-14	098867-10	Gas Regulator	1
10	M11084-38	M11084-38	Screw, 8-18 x .36	2
11	110801-02	110801-02	Inlet Tube	1
12	M11084-26	M11084-26	Screw, 10-16 x .38	15
13	108631-01	108631-01	Screw, 1" Blunt Tip Phillips	2
14	110790-03	110790-03	Rear Burner Bracket	2
15	110790-01	110790-01	Left Front Burner Bracket	1
16	110790-02	110790-02	Right Front Burner Bracket	1
17	099211-01	099211-01	Screw, 10-16 x 2.5	2
18	101329-20	098522-10	Gas Valve Assembly	1
19	098544-01	098544-01	Thermobulb Clip	1
20	**	**	Painted Base	1
21	110793-01	110793-01	Piezo Bracket	1
22	102445-01	102445-01	Piezo Ignitor Service Kit	1
23	111125-01	111125-01	T-Stat Heat Shield	1
24-1	111144-01	111144-01	Front Log	1
24-2	111144-02	111144-02	Control Cover Log	1
24-3	111144-03	111144-03	Rear and Middle Log	1
24-4	111144-04	111144-04	Crossover Log	1
PARTS AVAILABLE — NOT SHOWN				
	100563-01	100563-01	Warning Plate	1
	101054-01	101054-01	Lighting Instructions Plate	1
	100639-02	100639-02	Caution Decal	1
	101137-02	101137-02	Hardware Kit	1
	GA6060	GA6060	Lava Rock	1

**Not a field replaceable part.

WARRANTY INFORMATION

KEEP THIS WARRANTY

Model _____
Serial No. _____
Date Purchased _____

Always specify model and serial numbers when communicating with the factory.

We reserve the right to amend these specifications at any time without notice. The only warranty applicable is our standard written warranty. We make no other warranty, expressed or implied.

LIMITED WARRANTY VENT-FREE GAS LOG HEATERS

DESA Heating Products warrants this product to be free from defects in materials and components for two (2) years from the date of first purchase, provided that the product has been properly installed, operated and maintained in accordance with all applicable instructions. To make a claim under this warranty the Bill of Sale or cancelled check must be presented.

This warranty is extended only to the original retail purchaser. This warranty covers the cost of part(s) required to restore this heater to proper operating condition and an allowance for labor when provided by a DESA Heating Products Authorized Service Center. Warranty part(s) MUST be obtained through authorized dealers of this product and/or DESA Heating Products who will provide original factory replacement parts. Failure to use original factory replacement parts voids this warranty. The heater MUST be installed by a qualified installer in accordance with all local codes and instructions furnished with the unit.

This warranty does not apply to parts that are not in original condition because of normal wear and tear or parts that fail or become damaged as a result of misuse, accidents, lack of proper maintenance or defects caused by improper installation. Travel, diagnostic cost, labor, transportation and any and all such other costs related to repairing a defective heater will be the responsibility of the owner.

TO THE FULL EXTENT ALLOWED BY THE LAW OF THE JURISDICTION THAT GOVERNS THE SALE OF THE PRODUCT; THIS EXPRESS WARRANTY EXCLUDES ANY AND ALL OTHER EXPRESSED WARRANTIES AND LIMITS THE DURATION OF ANY AND ALL IMPLIED WARRANTIES, INCLUDING WARRANTIES OF MERCHANTABILITY AND FITNESS FOR A PARTICULAR PURPOSE TO TWO (2) YEARS ON ALL COMPONENTS FROM THE DATE OF FIRST PURCHASE; AND DESA HEATING PRODUCTS' LIABILITY IS HEREBY LIMITED TO THE PURCHASE PRICE OF THE PRODUCT AND DESA HEATING PRODUCTS SHALL NOT BE LIABLE FOR ANY OTHER DAMAGES WHATSOEVER INCLUDING INDIRECT, INCIDENTAL OR CONSEQUENTIAL DAMAGES.

Some states do not allow a limitation on how long an implied warranty lasts or an exclusion or limitation of incidental or consequential damages, so the above limitation on implied warranties or exclusion or limitation on damages may not apply to you.

This warranty gives you specific legal rights and you may also have other rights that vary from state to state.

For information about this warranty write:

DESATM

HEATING PRODUCTS

2701 Industrial Drive

P.O. Box 90004

Bowling Green, KY 42102-9004

www.desatech.com



111347 01

NOT A UPC

111347-01

Rev. E

09/04

Free Manuals Download Website

<http://myh66.com>

<http://usermanuals.us>

<http://www.somanuals.com>

<http://www.4manuals.cc>

<http://www.manual-lib.com>

<http://www.404manual.com>

<http://www.luxmanual.com>

<http://aubethermostatmanual.com>

Golf course search by state

<http://golfingnear.com>

Email search by domain

<http://emailbydomain.com>

Auto manuals search

<http://auto.somanuals.com>

TV manuals search

<http://tv.somanuals.com>