

DESA™

HEATING PRODUCTS

UNVENTED (VENT-FREE) BLUE FLAME GAS HEATER SAFETY INFORMATION AND INSTALLATION MANUAL



We recommend that our products be installed and serviced by professionals who are certified in the U.S. by NFI (National Fireplace Institute).
www.nficertified.org

MODELS VN20BT, VP20BT VN30BT AND VP30BT

WARNING: If the information in this manual is not followed exactly, a fire or explosion may result causing property damage, personal injury or loss of life.

- Do not store or use gasoline or other flammable vapors and liquids in the vicinity of this or any other appliance.
- **WHAT TO DO IF YOU SMELL GAS**
 - Do not try to light any appliance.
 - Do not touch any electrical switch; do not use any phone in your building.
 - Immediately call your gas supplier from a neighbor's phone. Follow the gas supplier's instructions.
 - If you cannot reach your gas supplier, call the fire department.
- Installation and service must be performed by a qualified installer, service agency or the gas supplier.

Save this manual for future reference.

For more information, visit www.desatech.com

Download from Www.Somanuals.com. All Manuals Search And Download.

WARNING: Improper installation, adjustment, alteration, service or maintenance can cause injury or property damage. Refer to this manual for correct installation and operational procedures. For assistance or additional information consult a qualified installer, service agency or the gas supplier.

WARNING: This is an unvented gas-fired heater. It uses air (oxygen) from the room in which it is installed. Provisions for adequate combustion and ventilation air must be provided. Refer to *Air for Combustion and Ventilation* section on page 5 of this manual.

This appliance may be installed in an aftermarket,* permanently located, manufactured (mobile) home, where not prohibited by local codes.

This appliance is only for use with the type of gas indicated on the rating plate. This appliance is not convertible for use with other gases.

* **Aftermarket: Completion of sale, not for purpose of resale, from the manufacturer**

State of Massachusetts: The installation must be made by a licensed plumber or gas fitter in the Commonwealth of Massachusetts.

Sellers of unvented propane or natural gas-fired supplemental room heaters shall provide to each purchaser a copy of 527 CMR 30 upon sale of the unit.

Vent-free gas products are prohibited for bedroom and bathroom installation in the Commonwealth of Massachusetts.

TABLE OF CONTENTS

Safety Information	3	Specifications	17
Local Codes	4	Service Hints	17
Unpacking	4	Technical Service	17
Product Information	4	Service Publications	17
Product Features	4	Troubleshooting	18
Air For Combustion and Ventilation	5	Replacement Parts	21
Installation	7	Accessories	21
Operating Heater	14	Illustrated Parts Breakdown and Parts List	22
Inspecting Heater	15	Warranty Information	Back Cover
Cleaning and Maintenance	16		

SAFETY INFORMATION

IMPORTANT: Read this owner's manual carefully and completely before trying to assemble, operate or service this heater. Improper use of this heater can cause serious injury or death from burns, fire, explosion, electrical shock and carbon monoxide poisoning.

⚠ DANGER: Carbon monoxide poisoning may lead to death!

Carbon Monoxide Poisoning: Early signs of carbon monoxide poisoning resemble the flu, with headaches, dizziness or nausea. If you have these signs, the heater may not be working properly. **Get fresh air at once!** Have heater serviced. Some people are more affected by carbon monoxide than others. These include pregnant women, people with heart or lung disease or anemia, those under the influence of alcohol and those at high altitudes.

Natural and Propane/LP Gas: Natural and propane/LP gases are fuel gases. Fuel gases are odorless. An odor-making agent are added to fuel gases. The odor helps you detect a fuel gas leak. However, the odor added to fuel gas can fade. Fuel gas may be present even though no odor exists. Make certain you read and understand all warnings. Keep this manual for reference. It is your guide to safe and proper operation of this heater.

⚠ WARNING: Any change to this heater or its controls can be dangerous.

⚠ WARNING: Do not use a blower insert, heat exchanger insert or other accessory not approved for use with this heater.

Due to high temperatures, the appliance should be located out of traffic and away from furniture and draperies.

Do not place clothing or other flammable material on or near the appliance. Never place any objects on the heater.

Surface of heater becomes very hot when running heater. Keep children and adults away from hot surface to avoid burns or clothing ignition. Heater will remain hot for a time after shut-down. Allow surface to cool before touching.

Carefully supervise young children when they are in the same room with heater.

Make sure grill guard is in place before running heater.

Keep the appliance area clear and free from combustible materials, gasoline and other flammable vapors and liquids.

1. This appliance is only for use with the type of gas indicated on the rating plate. This appliance is not convertible for use with other gases.
2. Do not place propane/LP supply tank(s) inside any structure. Locate propane/LP supply tank(s) outdoors (propane/LP models only).
3. If you smell gas
 - shut off gas supply
 - do not try to light any appliance
 - do not touch any electrical switch; do not use any phone in your building
 - immediately call your gas supplier from a neighbor's phone. Follow the gas supplier's instructions
 - if you cannot reach your gas supplier, call the fire department
4. This heater shall not be installed in a bedroom or bathroom.
5. This heater needs fresh, outside air ventilation to run properly. This heater has an Oxygen Depletion Sensing (ODS) safety shutoff system. The ODS shuts down the heater if not enough fresh air is available. See *Air for Combustion and Ventilation*, page 5.

SAFETY INFORMATION

Continued

- Keep all air openings in front and bottom of heater clear and free of debris. This will insure enough air for proper combustion.
- If heater shuts off, do not relight until you provide fresh, outside air. If heater keeps shutting off, have it serviced.
- Do not run heater
 - where flammable liquids or vapors are used or stored
 - under dusty conditions
- Do not use heater if any part has been under water. Immediately call a qualified service technician to inspect the room heater and to replace any part of the control system and any gas control which has been under water.
- Turn off and let cool before servicing. Only a qualified service person should service and repair heater.
- Operating heater above elevations of 4,500 feet could cause pilot outage.
- To prevent performance problems, do not use propane/LP fuel tank of less than 100 lbs. capacity (propane/LP models only).
- Provide adequate clearances around air openings.

LOCAL CODES

Install and use heater with care. Follow all local codes. In the absence of local codes, use the latest edition of *National Fuel Gas Code, ANSI Z223.1/NFPA 54**.

*Available from:

American National Standards Institute, Inc.
1430 Broadway
New York, NY 10018

National Fire Protection Association, Inc.
Batterymarch Park
Quincy, MA 02269

UNPACKING

- Remove heater from carton.
- Remove all protective packaging applied to heater for shipment.
- Check heater for any shipping damage. If heater is damaged, promptly return to dealer where you bought heater.

PRODUCT INFORMATION

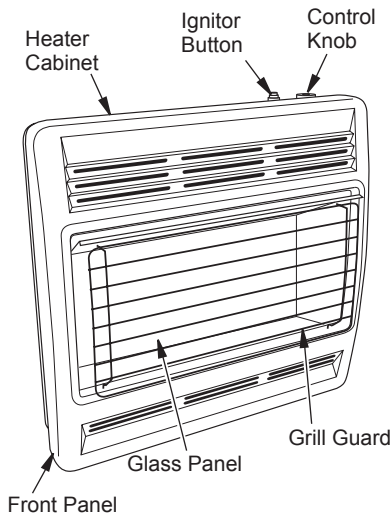

Figure 1 - Vent-Free Gas Heater

PRODUCT FEATURES

SAFETY DEVICE

This heater has a pilot with an Oxygen Depletion Sensing (ODS) safety shutoff system. The ODS/pilot is a required feature for vent-free room heaters. The ODS/pilot shuts off the heater if there is not enough fresh air.

PIEZO IGNITION SYSTEM

This heater has a piezo ignitor. This system requires no matches, batteries or other sources to light heater.

THERMOSTATIC HEAT CONTROL

Thermostat models have a thermostat sensing bulb and a control valve. This results in the greatest heater comfort. This can also result in lower gas bills.

AIR FOR COMBUSTION AND VENTILATION

⚠ WARNING: This heater shall not be installed in a confined space or unusually tight construction unless provisions are provided for adequate combustion and ventilation air. Read the following instructions to insure proper fresh air for this and other fuel-burning appliances in your home.

Today's homes are built more energy efficient than ever. New materials, increased insulation and new construction methods help reduce heat loss in homes. Home owners weather strip and caulk around windows and doors to keep the cold air out and the warm air in. During heating months, home owners want their homes as airtight as possible.

While it is good to make your home energy efficient, your home needs to breathe. Fresh air must enter your home. All fuel-burning appliances need fresh air for proper combustion and ventilation.

Exhaust fans, fireplaces, clothes dryers and fuel burning appliances draw air from the house to operate. You must provide adequate fresh air for these appliances. This will insure proper venting of vented fuel-burning appliances.

PROVIDING ADEQUATE VENTILATION

The following are excerpts from *National Fuel Gas Code, ANSI Z223.1/NFPA 54, Section 5.3, Air for Combustion and Ventilation*.

All spaces in homes fall into one of the three following ventilation classifications:

1. Unusually Tight Construction
2. Unconfined Space
3. Confined Space

The information on pages 5 through 7 will help you classify your space and provide adequate ventilation.

Unusually Tight Construction

The air that leaks around doors and windows may provide enough fresh air for combustion and ventilation. However, in buildings of unusually tight construction, you must provide additional fresh air.

Unusually tight construction is defined as construction where:

- a. walls and ceilings exposed to the outside atmosphere have a continuous water vapor retarder with a rating of one perm (6×10^{-11} kg per pa-sec- m^2) or less with openings gasketed or sealed and
- b. weather stripping has been added on openable windows and doors and
- c. caulking or sealants are applied to areas such as joints around window and door frames, between sole plates and floors, between wall-ceiling joints, between wall panels, at penetrations for plumbing, electrical and gas lines and at other openings.

If your home meets all of the three criteria above, you must provide additional fresh air. See *Ventilation Air From Outdoors*, page 7.

If your home does not meet all of the three criteria above, proceed to *Determining Fresh-Air Flow For Heater Location*, page 6.

Confined and Unconfined Space

The *National Fuel Gas Code, ANSI Z223.1/NFPA 54* defines a confined space as a space whose volume is less than 50 cubic feet per 1,000 Btu per hour (4.8 m^3 per kw) of the aggregate input rating of all appliances installed in that space and an unconfined space as a space whose volume is not less than 50 cubic feet per 1,000 Btu per hour (4.8 m^3 per kw) of the aggregate input rating of all appliances installed in that space. Rooms communicating directly with the space in which the appliances are installed*, through openings not furnished with doors, are considered a part of the unconfined space.

* Adjoining rooms are communicating only if there are doorless passageways or ventilation grills between them.

AIR FOR COMBUSTION AND VENTILATION

Continued

DETERMINING FRESH-AIR FLOW FOR HEATER LOCATION

Determining if You Have a Confined or Unconfined Space

Use this work sheet to determine if you have a confined or unconfined space.

Space: Includes the room in which you will install heater plus any adjoining rooms with doorless passageways or ventilation grills between the rooms.

1. Determine the volume of the space (length x width x height).

Length x Width x Height = _____ cu. ft.
(volume of space)

Example: Space size 20 ft. (length) x 16 ft. (width) x 8 ft. (ceiling height) = 2560 cu. ft. (volume of space)

If additional ventilation to adjoining room is supplied with grills or openings, add the volume of these rooms to the total volume of the space.

2. Multiply the space volume by 20 to determine the maximum Btu/Hr the space can support.

_____ (volume of space) x 20 = (Maximum Btu/Hr the space can support)

Example: 2560 cu. ft. (volume of space) x 20 = 51,200 (maximum Btu/Hr the space can support)

3. Add the Btu/Hr of all fuel burning appliances in the space.

Vent-free heater	_____	Btu/Hr
Gas water heater*	_____	Btu/Hr
Gas furnace	_____	Btu/Hr
Vented gas heater	_____	Btu/Hr
Gas fireplace logs	_____	Btu/Hr
Other gas appliances* +	_____	Btu/Hr
Total	= _____	Btu/Hr

* Do not include direct-vent gas appliances. Direct-vent draws combustion air from the outdoors and vents to the outdoors.

Example:

Gas water heater	_____	40,000	Btu/Hr
Vent-free heater	+ _____	20,000	Btu/Hr
Total	= _____	60,000	Btu/Hr

4. Compare the maximum Btu/Hr the space can support with the actual amount of Btu/Hr used.

_____ Btu/Hr (maximum the space can support)

_____ Btu/Hr (actual amount of Btu/Hr used)

Example:

51,200 Btu/Hr (maximum the space can support)

60,000 Btu/Hr (actual amount of Btu/Hr used)

The space in the above example is a confined space because the actual Btu/Hr used is more than the maximum Btu/Hr the space can support. You must provide additional fresh air. Your options are as follows:

- A. Rework worksheet, adding the space of an adjoining room. If the extra space provides an unconfined space, remove door to adjoining room or add ventilation grills between rooms. See *Ventilation Air From Inside Building*, page 7.
- B. Vent room directly to the outdoors. See *Ventilation Air From Outdoors*, page 7.
- C. Install a lower Btu/Hr heater, if lower Btu/Hr size makes room unconfined.

If the actual Btu/Hr used is less than the maximum Btu/Hr the space can support, the space is an unconfined space. You will need no additional fresh air ventilation.



WARNING: If the area in which the heater may be operated is smaller than that defined as an unconfined space or if the building is of unusually tight construction, provide adequate combustion and ventilation air by one of the methods described in the *National Fuel Gas Code, ANSI Z223.1/NFPA 54 Section 5.3* or applicable local codes.

AIR FOR COMBUSTION AND VENTILATION

Continued

VENTILATION AIR

Ventilation Air From Inside Building

This fresh air would come from an adjoining unconfined space. When ventilating to an adjoining unconfined space, you must provide two permanent openings: one within 12" of the ceiling and one within 12" of the floor on the wall connecting the two spaces (see options 1 and 2, Figure 2). You can also remove door into adjoining room (see option 3, Figure 2). Follow the *National Fuel Gas Code, ANSI Z223.1/NFPA 54, Section 5.3, Air for Combustion and Ventilation* for required size of ventilation grills or ducts.

Ventilation Air From Outdoors

Provide extra fresh air by using ventilation grills or ducts. You must provide two permanent openings: one within 12" of the ceiling and one within 12" of the floor. Connect these items directly to the outdoors or spaces open to the outdoors. These spaces include attics and crawl spaces. Follow the *National Fuel Gas Code, ANSI Z223.1/NFPA 54, Section 5.3, Air for Combustion and Ventilation* for required size of ventilation grills or ducts.

IMPORTANT: Do not provide openings for inlet or outlet air into attic if attic has a thermostat-controlled power vent. Heated air entering the attic will activate the power vent.

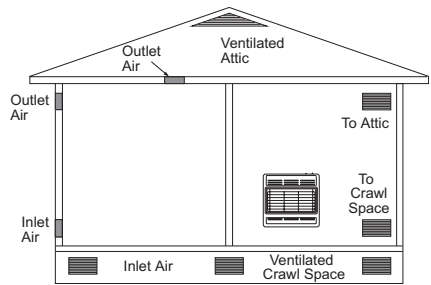

Figure 3 - Ventilation Air from Outdoors

INSTALLATION

NOTICE: This heater is intended for use as supplemental heat. Use this heater along with your primary heating system. Do not install this heater as your primary heat source. If you have a central heating system, you may run system's circulating blower while using heater. This will help circulate the heat throughout the house. In the event of a power outage, you can use this heater as your primary heat source.

WARNING: A qualified service person must install heater. Follow all local codes.

CHECK GAS TYPE

Use only the correct type of gas (natural or propane/LP). If your gas supply is not the correct gas type, do not install heater. Call dealer where you bought heater for proper type heater.

WARNING: This appliance is equipped for (natural or propane/LP) gas. Field conversion is not permitted.

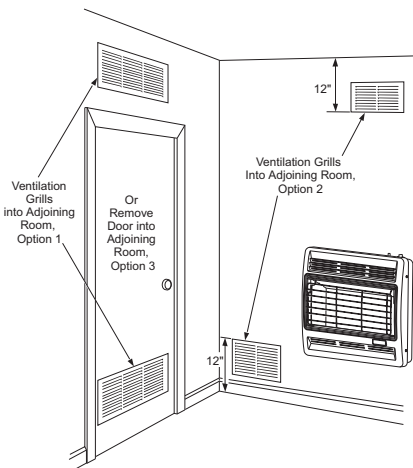

Figure 2 - Ventilation Air from Inside Building

INSTALLATION

Continued

INSTALLATION ITEMS

Before installing heater, make sure you have the items listed below.

- for propane/LP gas, external regulator (supplied by installer)
- piping (check local codes)
- sealant (resistant to propane/LP gas)
- equipment shutoff valve *
- ground joint union
- test gauge connection*
- sediment trap
- tee joint
- pipe wrench

* A CSA design-certified equipment shutoff valve with 1/8" NPT tap is an acceptable alternative to test gauge connection. The optional CSA design-certified equipment shutoff valve can be purchased from your dealer. See *Accessories*, page 21.

LOCATING HEATER

WARNING: Maintain the minimum clearances shown in Figure 4. If you can, provide greater clearances from floor, ceiling and joining wall.

You can locate heater on the floor, away from a wall. A wall mounting bracket and floor base stand are included with this heater. Determine which method is best for your application.

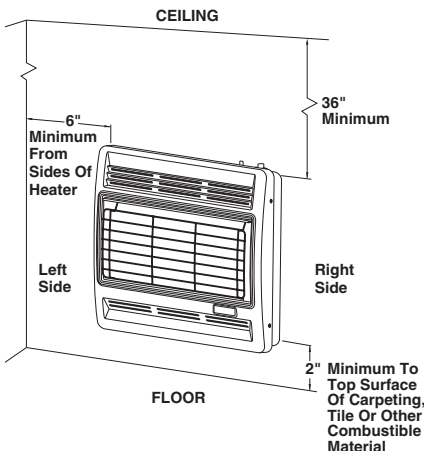

Figure 4 - Mounting Clearances As Viewed From Front of Heater

WARNING: Never install the heater

- in a bedroom or bathroom
- in a recreational vehicle
- where curtains, furniture, clothing or other flammable objects are less than 36 inches from the front, top or sides of the heater
- as a fireplace insert
- in high traffic areas
- in windy or drafty areas

CAUTION: This heater creates warm air currents. These currents move heat to wall surfaces next to heater. Installing heater next to vinyl or cloth wall coverings or operating heater where impurities (such as, but not limited to, tobacco smoke, aromatic candles, cleaning fluids, oil or kerosene lamps, etc.) in the air exist, may discolor walls or cause odors.

IMPORTANT: Vent-free heaters add moisture to the air. Although this is beneficial, installing heater in rooms without enough ventilation air may cause mildew to form from too much moisture. See *Air for Combustion and Ventilation*, page 5.

CAUTION: If you install the heater in a home garage

- heater pilot and burner must be at least 18 inches above floor
- locate heater where moving vehicle will not hit it

For convenience and efficiency, install heater

- where there is easy access for operation, inspection and service
- in coldest part of room

An optional fan kit is available from your dealer. See *Accessories*, page 21. If planning to use fan, locate heater near an electrical outlet.

INSTALLATION

Continued

THERMOSTAT SENSING BULB

The thermostat sensing bulb has been placed below the heater.

1. Place clamp on thermostat sensing bulb as shown in Figure 5. Clamp is provided in hardware package.
2. Snap clamp into upper mounting hole as shown in Figure 5. Mounting hole is located on lower left edge on back of heater. Make sure the thermostat sensing bulb is pointing up.

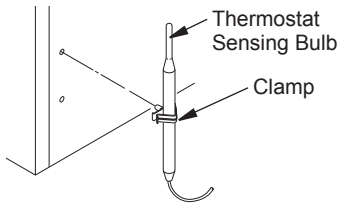

Figure 5 - Attaching Thermostat Sensing Bulb

INSTALLING HEATER TO WALL

Mounting Bracket

Locate mounting bracket in heater carton. Remove mounting bracket from heater carton.

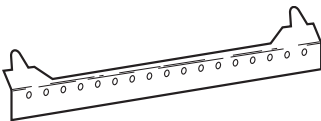

Figure 6 - Mounting Bracket

Removing Front Panel Of Heater

1. Remove the four painted screws, two on each side of front panel.
2. Pull bottom of front panel forward, then out.
3. Remove any remaining packaging materials.

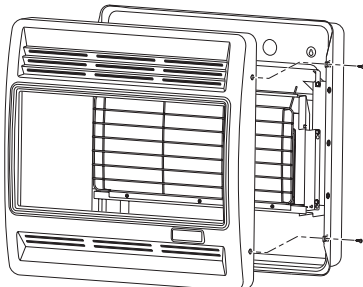

Figure 7 - Removing Front Panel Of Heater

Methods For Attaching Mounting Bracket To Wall

Only use last hole on each end of mounting bracket to attach bracket to wall. These two holes are 14 inches apart from their centers. Attach mounting bracket to wall in one of two ways:

1. Attaching to wall stud
2. Attaching to wall anchor

Attaching to Wall Stud: This method provides the strongest hold. Insert mounting screws through mounting bracket and into wall studs.

Attaching to Wall Anchor: This method allows you to attach mounting bracket to hollow walls (wall areas between studs) or to solid walls (concrete or masonry).

Decide which method better suits your needs. Either method will provide a secure hold for the mounting bracket.

Marking Screw Locations

1. Tape mounting bracket to wall where heater will be located. Make sure mounting bracket is level.

⚠ WARNING: Maintain minimum clearances shown in Figure 8. If you can, provide greater clearances from floor and joining wall.

2. Mark screw locations on wall (see Figure 8).
- Note:* Only mark last hole on each end of mounting bracket. Insert mounting screws through these holes only.
3. Remove tape and mounting bracket from wall.

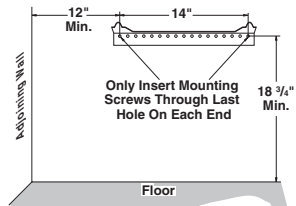

Models VN30BT & VP30BT

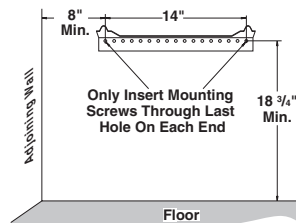

Models VN20BT & VP20BT

Figure 8 - Mounting Bracket Clearances

INSTALLATION

Continued

Attaching Mounting Bracket To Wall

Note: Wall anchors, mounting screws and spacers are in hardware package. The hardware package is provided with heater.

Attaching To Wall Stud Method

For attaching mounting bracket to wall studs

1. Drill holes at marked locations using 9/64" drill bit.
2. Place mounting bracket onto wall. Line up last hole on each end of bracket with holes drilled in wall.
3. Insert mounting screws through bracket and into wall studs.
4. Tighten screws until mounting bracket is firmly fastened to wall studs.

Attaching To Wall Anchor Method

For attaching mounting bracket to hollow walls (wall areas between studs) or solid walls (concrete or masonry)

1. Drill holes at marked locations using 5/16" drill bit. For solid walls (concrete or masonry), drill at least 1" deep.
2. Fold wall anchor as shown in Figure 9.
3. Insert wall anchor (wings first) into hole. Tap anchor flush to wall.
4. For thin walls (1/2" or less), insert red key into wall anchor. Push red key to "pop" open anchor wings (see Figure 10).

IMPORTANT: Do not hammer key!

For thick walls (over 1/2" thick) or solid walls, do not pop open wings.

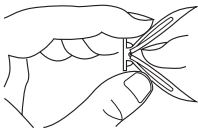

Figure 9 - Folding Anchor

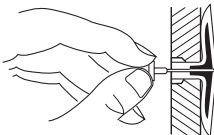

Figure 10 - Popping Open Anchor Wings For Thin Walls

5. Place mounting bracket onto wall. Line up last hole on each end of bracket with wall anchors.
6. Insert mounting screws through bracket and into wall anchors.
7. Tighten screws until mounting bracket is firmly fastened to wall.

Placing Heater On Mounting Bracket

1. Locate two horizontal slots on back panel of heater.
2. Place heater onto mounting bracket. Slide horizontal slots onto stand-out tabs on mounting bracket.

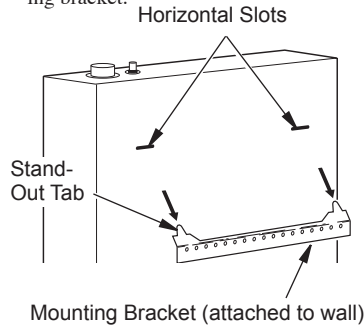

Figure 11 - Mounting Heater Onto Mounting Bracket

Installing Bottom Mounting Screws

1. Locate two bottom mounting holes. These holes are near bottom on back panel of heater (see Figure 12).
2. Mark screw locations on wall.
3. Remove heater from mounting bracket.

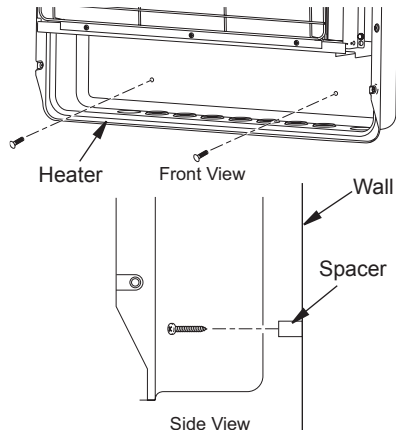

Figure 12 - Installing Bottom Mounting Screws

INSTALLATION

Continued

4. If installing bottom mounting screws into hollow or solid wall, install wall anchors. Follow steps 1 through 4 under *Attaching To Wall Anchor Method*, page 10

If installing bottom mounting screw into wall stud, drill holes at marked locations using 9/64" drill bit.

5. Replace heater onto mounting bracket.
6. Place spacers between bottom mounting holes and wall anchor or drilled hole.
7. Hold spacer in place with one hand. With other hand, insert mounting screw through bottom mounting hole and spacer. Place tip of screw in opening of wall anchor or drilled hole.
8. Tighten both screws until heater is firmly secured to wall. Do not over tighten.

Note: Do not replace front panel at this time. Replace front panel after making gas connections and checking for leaks (see pages 11 through 13).

MOUNTING HEATER TO FLOOR

Mounting Base Feet to Heater

1. Lay heater cabinet on its back on a table with the heater bottom overhanging the table edge.
2. Align holes in base foot with mounting holes on bottom of cabinet (see Figure 13).
3. Secure base foot to heater using sheet metal screws.
4. Repeat for other side.

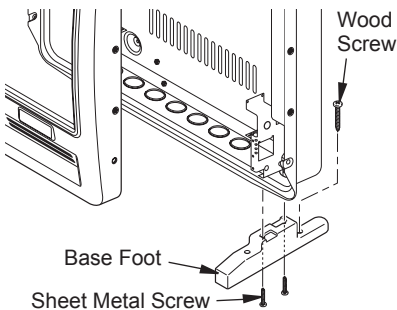

Figure 13 - Installing Base Feet

Mounting Base Feet to Floor (Where required by local code)

1. Remove front cover (see *Removing Front Panel of Heater*, page 9).
2. Position heater with base feet in desired location. Mark holes for drilling. Remove heater with base.

3. For carpeted floors, make a small cut with a sharp knife at marked locations prior to drilling. If mounting base to a wood floor, drill 1/8 inch diameter hole, 3/4 inch deep. (Do not use anchors in wood floors).

If mounting base to a concrete floor, drill with 1/4 inch diameter concrete drill bit, 1 3/8 inches into floor. Insert anchors completely into holes.

4. Reposition heater with base feet over holes. Secure base to floor with wood screws. See Figure 13.

CONNECTING TO GAS SUPPLY

WARNING: This appliance requires a 3/8" NPT (National Pipe Thread) inlet connection to the pressure regulator.

WARNING: A qualified service person must connect heater to gas supply. Follow all local codes.

WARNING: For natural gas, never connect heater to private (non-utility) gas wells. This gas is commonly known as wellhead gas.

IMPORTANT: For natural gas, check gas line pressure before connecting heater to gas line. Gas line pressure must be no greater than 10.5 inches of water. If gas line pressure is higher, heater regulator damage could occur.

CAUTION: For propane/LP gas, never connect heater directly to the propane/LP supply. This heater requires an external regulator (not supplied). Install the external regulator between the heater and propane/LP supply.

For propane/LP gas, the installer must supply an external regulator. The external regulator will reduce incoming gas pressure. You must reduce incoming gas pressure to between 11 and 14 inches of water. If you do not reduce incoming gas pressure, heater regulator damage could occur. Install the external regulator with the vent pointing down as shown in Figure 14, page 12. Pointing the vent down protects it from freezing rain or sleet.

INSTALLATION

Continued

CAUTION: Use only new, black iron or steel pipe. Internally-tinned copper tubing may be used in certain areas. Check your local codes. Use pipe of large enough diameter to allow proper gas volume to heater. If pipe is too small, undue loss of volume will occur.

Typical Inlet Pipe Diameters

VN20BT, VP20BT - 3/8" or greater

VN30BT, VP30BT - 1/2" or greater

Installation must include equipment shutoff valve, union and plugged 1/8" NPT tap. Locate NPT tap within reach for test gauge hook up. NPT tap must be upstream from heater (see Figure 15).

IMPORTANT: Install an equipment shutoff valve in an accessible location. The equipment shutoff valve is for turning on or shutting off the gas to the appliance.

Apply pipe joint sealant lightly to male NPT threads. This will prevent excess sealant from going into pipe. Excess sealant in pipe could result in clogged heater valves.

WARNING: Use pipe joint sealant that is resistant to liquid petroleum (LP) gas.

Install sediment trap in supply line as shown in Figure 15. Locate sediment trap where it is within reach for cleaning. Locate sediment trap where trapped matter is not likely to freeze. A sediment trap traps moisture and contaminants. This keeps them from going into heater controls. If sediment trap is not installed or is installed wrong, heater may not run properly.

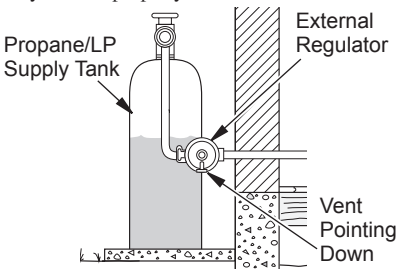

Figure 14 - External Regulator With Vent Pointing Down

IMPORTANT: Hold the pressure regulator with wrench when connecting it to gas piping and/or fittings. Do not over tighten pipe connection to regulator. The regulator body could be damaged.

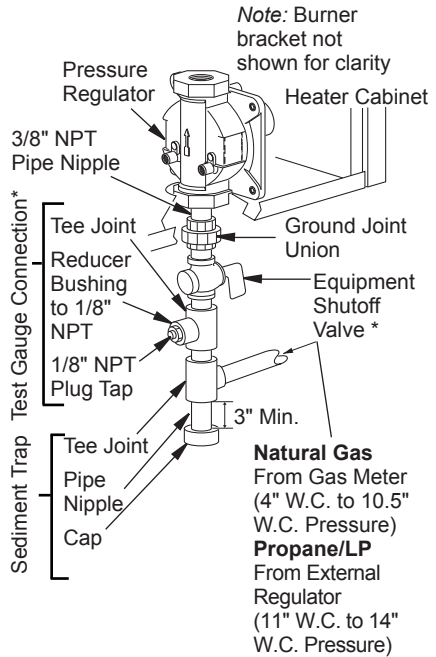

Figure 15 - Gas Connection

* A CSA design-certified equipment shutoff valve with 1/8" NPT tap is an acceptable alternative to test gauge connection. Purchase the optional CSA design-certified equipment shutoff valve from your dealer. See *Accessories*, page 21.

CHECKING GAS CONNECTIONS

WARNING: Test all gas piping and connections for leaks after installing or servicing. Correct all leaks at once.

WARNING: Never use an open flame to check for a leak. Apply a noncorrosive leak detection fluid to all joints. Bubbles forming show a leak. Correct all leaks at once.

INSTALLATION

Continued

CAUTION: For propane/LP gas, make sure external regulator has been installed between propane/LP supply and heater. See guidelines under *Connecting to Gas Supply*, page 11.

PRESSURE TESTING GAS SUPPLY PIPING SYSTEM

Test Pressures In Excess Of 1/2 PSIG (3.5 kPa)

1. Disconnect appliance with its appliance main gas valve (control valve) and equipment shutoff valve from gas supply piping system. Pressures in excess of 1/2 psig will damage heater regulator.
2. Cap off open end of gas pipe where equipment shutoff valve was connected.
3. Pressurize supply piping system by either opening propane/LP supply tank valve for propane/LP gas or opening main gas valve located on or near gas meter for natural gas or using compressed air.
4. Check all joints of gas supply piping system. Apply a noncorrosive leak detection fluid to all joints. Bubbles forming show a leak.
5. Correct all leaks at once.
6. Reconnect heater and equipment shutoff valve to gas supply. Check reconnected fittings for leaks.

Test Pressures Equal To or Less Than 1/2 PSIG (3.5 kPa)

1. Close equipment shutoff valve (see Figure 16).
2. Pressurize supply piping system by either opening propane/LP supply tank valve for propane/LP gas or opening main gas valve located on or near gas meter for natural gas or using compressed air.
3. Check all joints from gas meter for natural gas (see Figure 17) or propane/LP supply tank for propane/LP gas, to equipment shutoff valve (see Figure 18). Apply a noncorrosive leak detection fluid to all joints. Bubbles forming show a leak.
4. Correct all leaks at once.

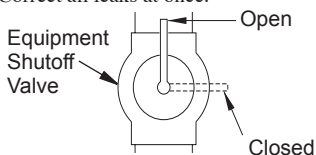

Figure 16 - Equipment Shutoff Valve

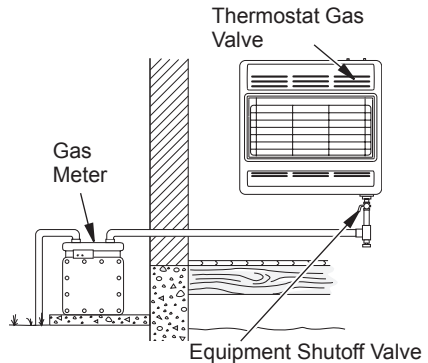

Figure 17 - Checking Gas Joints for Natural Gas

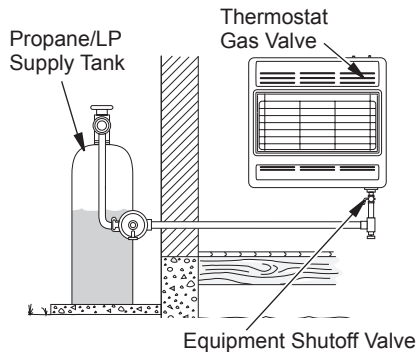

Figure 18 - Checking Gas Joints for Propane/LP Gas

PRESSURE TESTING HEATER GAS CONNECTIONS

1. Open equipment shutoff valve (see Figure 16).
2. For natural gas open main gas valve located on or near gas meter. For propane/LP gas open propane/LP supply tank valve.
3. Make sure control knob of heater is in the OFF position.
4. Check all joints from equipment shutoff valve to thermostat gas valve (see Figure 17 or 18). Apply a noncorrosive leak detection fluid to all joints. Bubbles forming show a leak.
5. Correct all leaks at once.
6. Light heater (see *Operating Heater*, page 14). Check all other internal joints for leaks.
7. Turn off heater (see *To Turn Off Gas to Appliance*, page 15).
8. Replace front panel.

OPERATING HEATER

FOR YOUR SAFETY READ BEFORE LIGHTING

WARNING: If you do not follow these instructions exactly, a fire or explosion may result causing property damage, personal injury or loss of life.

A. This appliance has a pilot which must be lighted by hand. When lighting the pilot, follow these instructions exactly.

B. **BEFORE LIGHTING** smell all around the appliance area for gas. Be sure to smell next to the floor because some gas is heavier than air and will settle on the floor.

WHAT TO DO IF YOU SMELL GAS

- Do not try to light any appliance.
- Do not touch any electric switch; do not use any phone in your building.
- Immediately call your gas supplier from a neighbor's phone. Follow the gas supplier's instructions.
- If you cannot reach your gas supplier, call the fire department.

C. Use only your hand to push in or turn the gas control knob. Never use tools. If the knob will not push in or turn by hand, don't try to repair it, call a qualified service technician or gas supplier. Force or attempted repair may result in a fire or explosion.

D. Do not use this appliance if any part has been under water. Immediately call a qualified service technician to inspect the appliance and to replace any part of the control system and any gas control which has been under water.

LIGHTING INSTRUCTIONS

1. **STOP!** Read the safety information above.
2. Make sure equipment shutoff valve is fully open.
3. Turn control knob clockwise  to the OFF position.
4. Wait five (5) minutes to clear out any gas. Then smell for gas, including near the floor. If you smell gas, **STOP!** Follow "B" in the safety information above. If you don't smell gas, go to the next step.

5. Turn control knob counterclockwise  to the PILOT position. Press in control knob for five (5) seconds (see Figure 19).

Note: You may be running this heater for the first time after hooking up to gas supply. If so, the control knob may need to be pressed in for 30 seconds or more. This will allow air to bleed from the gas system.

• If control knob does not pop up when released, contact a qualified service person or gas supplier for repairs.

6. With control knob pressed in, push down and release ignitor button. This will light pilot. The pilot is attached to the front of burner. The pilot can be seen through the glass panel. If needed, keep pressing ignitor button until pilot lights.

Note: If pilot does not stay lit, refer to *Troubleshooting*, page 18. Also contact a qualified service person or gas supplier for repairs. Until repairs are made, light pilot with match. To light pilot with match, see *Manual Lighting Procedure*, page 15.

7. Keep control knob pressed in for 30 seconds after lighting pilot. After 30 seconds, release control knob.

• If control knob does not pop up when released, contact a qualified service person or gas supplier for repairs.

Note: If pilot goes out, repeat steps 3 through 7. This heater has a safety interlock system. Wait one (1) minute before lighting pilot again.

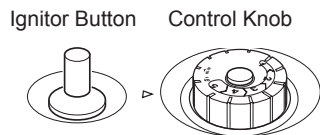

Figure 19 - Control Knob In The OFF Position

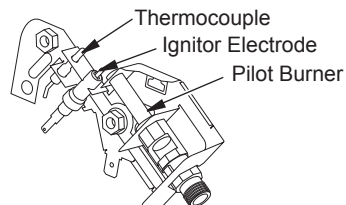



Figure 20 - Pilot (actual pilot may vary)

OPERATING HEATER

Continued

- Turn control knob counterclockwise  to desired heating level. The main burner should light. Set control knob to any heat level between 1 and 5.

CAUTION: Do not try to adjust heating levels by using the equipment shutoff valve.

TO TURN OFF GAS TO APPLIANCE

Shutting Off Heater

- Turn control knob clockwise  to the OFF position.
- Turn off all electric power to the appliance if service is to be performed.

Shutting Off Burner Only (pilot stays lit)

Turn control knob clockwise  to the PILOT position.

THERMOSTAT CONTROL OPERATION

The thermostatic control used on these models differs from standard thermostats. Standard thermostats simply turn on and off the burner. The thermostat used on this heater senses the room temperature. The thermostat adjusts the amount of gas flow to the burner. This increases or decreases the burner flame height. At times the room may exceed the set temperature. If so, the burner will shut off. The burner will cycle back on when room temperature drops below the set temperature. The control knob can be set to any heat level between 1 and 5. Selecting the 5 setting will cause the burner to remain fully on without modulating down in most cases.

Note: The thermostat sensing bulb measures the temperature of air near the heater cabinet. This may not always agree with room temperature (depending on housing construction, installation location, room size, open air temperatures, etc.). Frequent use of your heater will let you determine your own comfort levels.

MANUAL LIGHTING PROCEDURE

- Remove front panel (see Figure 7, page 9).
- Follow steps 1 through 5 under *Lighting Instructions*, page 14.

- With control knob pressed in, strike match. Hold match to pilot until pilot lights.
- Keep control knob pressed in for 30 seconds after lighting pilot. After 30 seconds, release control knob. Now follow step 8, under *Lighting Instructions*, pages 14 and 15.
- Replace front panel.

INSPECTING HEATER

Check pilot flame pattern and burner flame pattern often.

PILOT FLAME PATTERN

Figure 21 shows a correct pilot flame pattern. Figure 22 shows an incorrect pilot flame pattern. The incorrect pilot flame is not touching the thermocouple. This will cause the thermocouple to cool. When the thermocouple cools, the heater will shut down.

If pilot flame pattern is incorrect, as shown in Figure 22

- turn heater off (see *To Turn Off Gas to Appliance*)
- see *Troubleshooting*, page 18

Note: The pilot flame on natural gas units will have a slight curve, but flame should be blue and

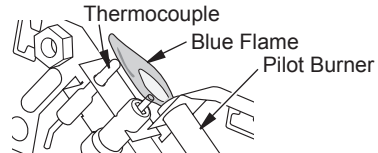

Figure 21 - Correct Pilot Flame Pattern

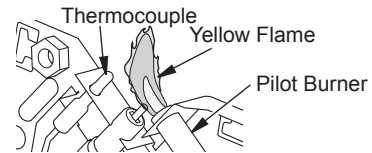

Figure 22 - Incorrect Pilot Flame Pattern

BURNER FLAME PATTERN

WARNING: If yellow tipping occurs, your heater could produce increased levels of carbon monoxide.

NOTICE: Do not mistake orange flames with yellow tipping. Dirt or other fine particles enter the heater and burn causing brief patches of orange flame.

INSPECTING HEATER

Continued

Figure 23 shows a correct burner flame pattern. Figure 24 shows an incorrect burner flame pattern. The incorrect burner flame pattern shows yellow tipping of the flame. It also shows the flame higher than 1/2 the glass panel height.

If burner flame pattern is incorrect, as shown in Figure 24

- turn heater off (see *To Turn Off Gas To Appliance*, page 15)
- see Troubleshooting, page 18

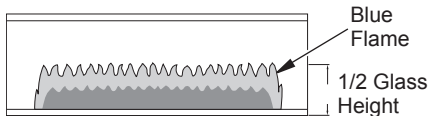

Figure 23 - Correct Burner Flame Pattern

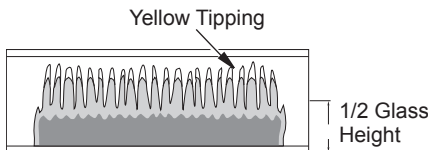

Figure 24 - Incorrect Burner Flame Pattern

CLEANING AND MAINTENANCE

WARNING: Turn off heater and let cool before cleaning.

CAUTION: You must keep control areas, burner and circulating air passageways of heater clean. Inspect these areas of heater before each use. Have heater inspected yearly by a qualified service person. Heater may need more frequent cleaning due to excessive lint from carpeting, bedding material, pet hair, etc.

WARNING: Failure to keep the primary air opening(s) of the burner(s) clean may result in sooting and property damage.

ODS/PILOT AND BURNER

Use a vacuum cleaner, pressurized air or small, soft bristled brush to clean.

BURNER PILOT AIR INLET

The primary air inlet holes allow the proper amount of air to mix with the gas. This provides a clean burning flame. Keep these holes clear of dust, dirt and lint. Clean these air inlet holes prior to each heating season. Blocked air holes will create soot. We recommend that you clean the unit every three months during operation and have heater inspected yearly by a qualified service person.

We also recommend that you keep the burner tube and pilot assembly clean and free of dust and dirt. To clean these parts we recommend using compressed air no greater than 30 PSI. Your local computer store, hardware store or home center may carry compressed air in a can. You can use a vacuum cleaner in the blow position. If using compressed air in a can, please follow the directions on the can. If you don't follow directions on the can, you could damage the pilot assembly.

1. Shut off the unit, including the pilot. Allow the unit to cool for at least thirty minutes.
2. Inspect burner, pilot for dust and dirt.
3. Blow air through the ports/slots and holes in the burner.
4. Never insert objects into the pilot tube.

Clean the pilot assembly also. A yellow tip on the pilot flame indicates dust and dirt in the pilot assembly. There is a small pilot air inlet about two inches from where the pilot flame comes out of the pilot assembly (see Figure 25). With the unit off, lightly blow air through the air inlet. You may blow through a drinking straw if compressed air is not available.

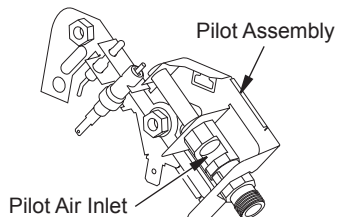

Figure 25 - Pilot Inlet Air (Propane/LP Pilot Shown)

CABINET

Air Passageways

Use a vacuum cleaner or pressurized air to clean.

Exterior

Use a soft cloth dampened with a mild soap and water mixture. Wipe the cabinet to remove dust.

SPECIFICATIONS

	VN20BT	VN30BT
Btu (Variable)	10,000/20,000	15,000/30,000
Type Gas	Natural	Natural
Ignition	Piezo	Piezo
Pressure Regulator Setting	3" W.C.	3" W.C.
Inlet Gas Pressure (in. of water)		
Maximum	10.5"	10.5"
Minimum	4"	4"
Dimensions, Inches (H x W x D)		
Heater (Includes knobs & grill)	24.25 x 18.25 x 7	24.25 x 25.75 x 7
Carton	26.25 x 21.25 x 9	26.25 x 29 x 9
Weight (pounds)		
Heater	20	28
Shipping	25	33
	VP20BT	VP30BT
Btu (Variable)	10,000/20,000	15,000/30,000
Type Gas	Propane/LP	Propane/LP
Ignition	Piezo	Piezo
Pressure Regulator Setting	8" W.C.	8" W.C.
Inlet Gas Pressure (in. of water)		
Maximum	14"	14"
Minimum	11"	11"
Dimensions, Inches (H x W x D)		
Heater (Includes knobs & grill)	24.25 x 18.25 x 7	24.25 x 25.75 x 7
Carton	26.25 x 21.25 x 9	26.25 x 29 x 9
Weight (pounds)		
Heater	20	28
Shipping	25	33

SERVICE HINTS

When Gas Pressure Is Too Low

- pilot will not stay lit
- burner will have delayed ignition
- heater will not produce specified heat
- propane/LP gas supply may be low

You may feel your gas pressure is too low. If so, contact your local natural or propane/LP gas supplier.

TECHNICAL SERVICE

You may have further questions about installation, operation or troubleshooting. If so, contact DESA Heating Products' Technical Service Department at 1-866-672-6040. When calling please have your model and serial numbers of your heater ready.

You can also visit DESA Heating Products' technical service web site at www.desatech.com.

SERVICE PUBLICATIONS

You can purchase a service manual from the address listed on the back page of this manual. Send a check for \$5.00 payable to DESA Heating Products.

TROUBLESHOOTING

 **WARNING: Turn off and unplug heater and let cool before servicing. Only a qualified service person should service and repair heater.**

 **CAUTION: Never use a wire, needle or similar object to clean ODS/pilot. This can damage ODS/pilot unit.**

Note: All troubleshooting items are listed in order of operation.

OBSERVED PROBLEM	POSSIBLE CAUSE	REMEDY
When ignitor button is pressed, there is no spark at ODS/pilot	1. Ignitor electrode positioned wrong	1. Replace pilot assembly
	2. Ignitor electrode broken	2. Replace pilot assembly
	3. Ignitor electrode not connected to ignitor cable	3. Reconnect ignitor cable
	4. Ignitor cable pinched or wet	4. Free ignitor cable if pinched by any metal or tubing. Keep ignitor cable dry
	5. Broken ignitor cable	5. Replace ignitor cable
	6. Bad piezo ignitor	6. Replace piezo ignitor
When ignitor button is pressed, there is spark at ODS/pilot but no ignition	1. Gas supply turned off or equipment shutoff valve closed	1. Turn on gas supply or open equipment shutoff valve
	2. Control knob not in PILOT position	2. Turn control knob to PILOT position
	3. Control knob not pressed in while in PILOT position	3. Press in control knob while in PILOT position
	4. Air in gas lines when installed	4. Continue holding down control knob. Repeat igniting operation until air is removed
	5. Depleted gas supply (propane/LP gas only)	5. Contact local propane/LP gas company
	6. ODS/pilot is clogged	6. Clean ODS/pilot (see <i>Cleaning and Maintenance</i> , page 16) or replace ODS/pilot assembly
	7. Gas regulator setting is not correct	7. Replace gas regulator

TROUBLESHOOTING

Continued

OBSERVED PROBLEM	POSSIBLE CAUSE	REMEDY
ODS/pilot lights but flame goes out when control knob is released	<ol style="list-style-type: none">1. Control knob not fully pressed in2. Control knob not pressed in long enough3. Safety interlock system has been triggered4. Equipment shutoff valve not fully open5. Thermocouple connection loose at control valve6. Pilot flame not touching thermocouple, which allows thermocouple to cool, causing pilot flame to go out. This problem could be caused by one or both of the following: A) Low gas pressure B) Dirty or partially clogged ODS/pilot7. Thermocouple damaged8. Control valve damaged	<ol style="list-style-type: none">1. Press in control knob fully2. After ODS/pilot lights, keep control knob pressed in 30 seconds3. Wait one minute for safety interlock system to reset. Repeat ignition operation4. Fully open equipment shutoff valve5. Hand tighten until snug, then tighten 1/4 turn more6. A) Contact local natural or propane/LP gas company B) Clean ODS/pilot (see <i>Cleaning and Maintenance</i>, page 16) or replace ODS/pilot assembly7. Replace pilot assembly8. Replace control valve
Burner does not light after ODS/pilot is lit	<ol style="list-style-type: none">1. Burner orifice is clogged2. Inlet gas pressure is too low	<ol style="list-style-type: none">1. Clean burner (see <i>Cleaning and Maintenance</i>, page 16) or replace burner orifice2. Contact local natural or propane/LP gas company
Delayed ignition of burner	<ol style="list-style-type: none">1. Manifold pressure is too low2. Burner orifice is clogged	<ol style="list-style-type: none">1. Contact local natural or propane/LP gas company2. Clean burner (see <i>Cleaning and Maintenance</i>, page 16) or replace burner orifice
Burner backfiring during combustion	<ol style="list-style-type: none">1. Burner orifice is clogged or damaged2. Burner damaged3. Gas regulator defective	<ol style="list-style-type: none">1. Clean burner (see <i>Cleaning and Maintenance</i>, page 16) or replace burner orifice2. Replace burner3. Replace gas regulator
Yellow flame during burner combustion	<ol style="list-style-type: none">1. Not enough air2. Gas regulator defective3. Clogged or dirty burner	<ol style="list-style-type: none">1. Check burner for dirt and debris. If found, clean burner (see <i>Cleaning and Maintenance</i>, page 16)2. Replace gas regulator3. Clean burner (see <i>Cleaning and Maintenance</i>, page 16)
Slight smoke or odor during initial operation	<ol style="list-style-type: none">1. Residues from manufacturing processes	<ol style="list-style-type: none">1. Problem will stop after a few hours of operation

TROUBLESHOOTING

Continued



WARNING: If you smell gas

- Shut off gas supply.
- Do not try to light any appliance.
- Do not touch any electrical switch; do not use any phone in your building.
- Immediately call your gas supplier from a neighbor's phone. Follow the gas supplier's instructions.
- If you cannot reach your gas supplier, call the fire department.

IMPORTANT: Operating heater where impurities in air exist may create odors. Cleaning supplies, paint, paint remover, cigarette smoke, cements and glues, new carpet or textiles, etc., create fumes. These fumes may mix with combustion air and create odors.

OBSERVED PROBLEM	POSSIBLE CAUSE	REMEDY
Heater produces a whistling noise when burner is lit	<ol style="list-style-type: none">1. Turning control knob to position 5 when burner is cold2. Air in gas line3. Air passageways on heater blocked4. Dirty or partially clogged burner orifice	<ol style="list-style-type: none">1. Turn control knob to position 1 and let warm up for a minute2. Operate burner until air is removed from line. Have gas line checked by local natural or propane/LP gas company3. Observe minimum installation clearances (see Figure 4, page 8)4. Clean burner (see <i>Cleaning and Maintenance</i>, page 16) or replace burner orifice
White powder residue forming within burner box or on adjacent walls or furniture	<ol style="list-style-type: none">1. When heated, vapors from furniture polish, wax, carpet cleaner, etc., may turn into white powder residue	<ol style="list-style-type: none">1. Turn heater off when using furniture polish, wax, carpet cleaners or similar products
Heater produces a clicking/ticking noise just after burner is lit or shut off	<ol style="list-style-type: none">1. Metal expanding while heating or contracting while cooling	<ol style="list-style-type: none">1. This is common with most heaters. If noise is excessive, contact qualified service person
Heater produces unwanted odors	<ol style="list-style-type: none">1. Heater burning vapors from paint, hair spray, glues, etc. (see <i>IMPORTANT</i> statement above)2. Low fuel supply (propane/LP gas only)3. Gas leak. See Warning statement above	<ol style="list-style-type: none">1. Ventilate room. Stop using odor causing products while heater is running2. Refill supply tank3. Locate and correct all leaks (see <i>Checking Gas Connections</i>, page 12)
Heater shuts off in use (ODS operates)	<ol style="list-style-type: none">1. Not enough fresh air is available2. Low line pressure3. ODS/pilot is partially clogged	<ol style="list-style-type: none">1. Open window and/or door for ventilation2. Contact local natural or propane/LP gas company3. Clean ODS/pilot (see <i>Cleaning and Maintenance</i>, page 17)

TROUBLESHOOTING

Continued

OBSERVED PROBLEM	POSSIBLE CAUSE	REMEDY
Gas odor even when control knob is in OFF position	1. Gas leak. See Warning statement on page 21 2. Control valve defective	1. Locate and correct all leaks (see <i>Checking Gas Connections</i> , page 12) 2. Replace control valve
Gas odor during combustion	1. Foreign matter between control valve and burner 2. Gas leak. See Warning statement on page 21	1. Take apart gas tubing and remove foreign matter 2. Locate and correct all leaks (see <i>Checking Gas Connections</i> , page 12)
Moisture/condensation noticed on windows	1. Not enough combustion/ventilation air	1. Refer to <i>Air for Combustion and Ventilation requirements</i> (page 5)

REPLACEMENT PARTS

Note: Use only original replacement parts. This will protect your warranty coverage for parts replaced under warranty.

PARTS UNDER WARRANTY

Contact authorized dealers of this product. If they can't supply original replacement part(s), call DESA Heating Products' Technical Service Department at 1-866-672-6040.

When calling DESA Heating Products, have ready

- your name
- your address
- model and serial numbers of your heater
- how heater was malfunctioning
- type of gas used (propane/LP or natural gas)
- purchase date

Usually, we will ask you to return the part to the factory.

PARTS NOT UNDER WARRANTY

Contact authorized dealers of this product. If they can't supply original replacement part(s), call DESA Heating Products at 1-866-672-6040 for referral information.

When calling DESA Heating Products, have ready

- model number of your heater
- the replacement part number

ACCESSORIES

Purchase these heater accessories from your local dealer. If they can not supply these accessories, call DESA Heating Products at 1-866-672-6040 for referral information. You can also write to the address listed on the back page of this manual.

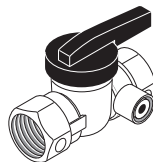

EQUIPMENT SHUTOFF VALVE GA5010

For all models. Equipment shutoff valve with 1/8" NPT tap.

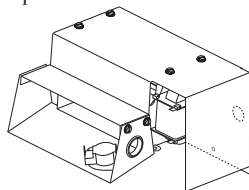

FAN KITS - GA3250T

For all models. Provides better heat distribution. Makes heater more efficient. Complete installation and operating instructions included.

Thermostatically-controlled, blower turns itself on and off as required.

ELECTRONIC IGNITOR KIT - GA435 Not Shown

For all piezo ignitor models. Provides easier lighting of the pilot.

ILLUSTRATED PARTS BREAKDOWN

MODELS

VN20BT, VP20BT

VN30BT, VP30BT

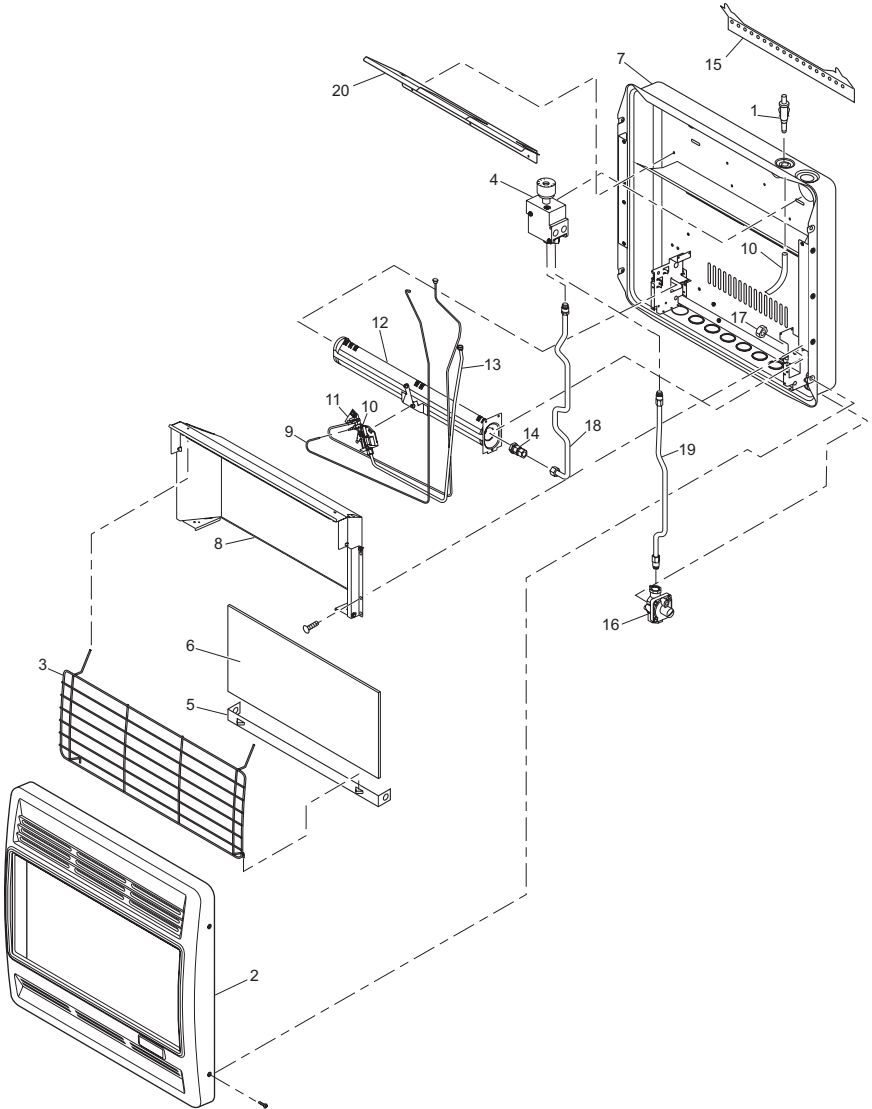

PARTS LIST

This list contains replaceable parts used in your heater. When ordering parts, follow the instructions listed under *Replacement Parts* on page 21 of this manual.

KEY NO.	PART NUMBER				DESCRIPTION	QTY.
	VN20BT	VP20BT	VN30BT	VP30BT		
1	097159-04	097159-04	097159-04	097159-04	Piezo Ignitor	1
2	107672-01	107672-01	107675-01	107675-01	Front Panel	1
3	103476-01	103476-01	103476-02	103476-02	Grill Guard	1
4	098522-28	098522-11	098522-12	098522-13	Thermostat Gas Valve	1
5	104189-01	104189-01	104189-02	104189-02	Bottom Glass Retainer	1
6	098260-09	098260-09	098260-10	098260-10	Glass Panel	1
7	**	**	**	**	Cabinet	1
8	107894-10	107894-10	107894-11	107894-11	Deflector Assembly	1
9	098271-09	098271-09	098271-09	098271-09	Ignitor Cable	1
10	098249-01	098249-01	098249-01	098249-01	Nut, M5	2
11	110803-01	110803-02	110803-01	110803-02	ODS/Pilot Assembly	1
	110186-01	110186-01	110186-01	110186-01	Thermocouple Kit	1
12	103446-01	103446-01	103447-01	103447-01	Burner	1
13	099387-03	099387-03	099387-03	099387-03	3/16" Pilot Tubing	1
14	103845-06	103845-05	103845-08	103845-07	Injector	1
15	099066-02	099066-02	099066-02	099066-02	Mounting Bracket	1
16	099415-17	099415-18	099415-17	099415-18	Pressure Regulator	1
17	NJF 8C	NJF 8C	NJF 8C	NJF 8C	Hex Nut	1
18	103255-02	103255-02	103255-02	103255-02	3/8" Outlet (Burner) Tubing	1
19	103256-02	103256-02	103256-02	103256-02	3/8" Inlet Tubing	1
20	109303-04	109303-04	109303-03	109303-03	Baffle	1
PARTS AVAILABLE — NOT SHOWN						
	100642-03	100642-03	100642-03	100642-03	Hardware Assembly	1
	105345-01	105345-01	105345-01	105345-01	Cable Tie	1
	107888-01	107888-01	107888-01	107888-01	Control Position Label	1
	109483-01	109483-01	109483-01	109483-01	Lighting Instruction Plate	1
	GA4550	GA4550	GA4550	GA4550	Base Kit	1

** Not a field replaceable part.

WARRANTY INFORMATION

KEEP THIS WARRANTY

Model _____
Serial No. _____
Date of Purchase _____

Always specify model and serial numbers when communicating with the factory.

We reserve the right to amend these specifications at any time without notice. The only warranty applicable is our standard written warranty. We make no other warranty, expressed or implied.

LIMITED WARRANTY

VENT-FREE RESIDENTIAL GAS HEATERS

DESA Heating Products warrants this product to be free from defects in materials and components for four (4) years from the date of first purchase, provided that the product has been properly installed, operated and maintained in accordance with all applicable instructions. To make a claim under this warranty the Bill of Sale or cancelled check must be presented.

This warranty is extended only to the original retail purchaser. This warranty covers the cost of part(s) required to restore this heater to proper operating condition and an allowance for labor when provided by a DESA Authorized Service Center. Warranty part(s) MUST be obtained through authorized dealers of this product and/or DESA Heating Products who will provide original factory replacement parts. Failure to use original factory replacement parts voids this warranty. The heater MUST be installed by a qualified installer in accordance with all local codes and instructions furnished with the unit.

This warranty does not apply to parts that are not in original condition because of normal wear and tear or parts that fail or become damaged as a result of misuse, accidents, lack of proper maintenance or defects caused by improper installation. Travel, diagnostic cost, labor, transportation and any and all such other costs related to repairing a defective heater will be the responsibility of the owner.

TO THE FULL EXTENT ALLOWED BY THE LAW OF THE JURISDICTION THAT GOVERNS THE SALE OF THE PRODUCT; THIS EXPRESS WARRANTY EXCLUDES ANY AND ALL OTHER EXPRESSED WARRANTIES AND LIMITS THE DURATION OF ANY AND ALL IMPLIED WARRANTIES, INCLUDING WARRANTIES OF MERCHANTABILITY AND FITNESS FOR A PARTICULAR PURPOSE TO FOUR (4) YEARS FROM THE DATE OF FIRST PURCHASE; AND DESA HEATING PRODUCTS' LIABILITY IS HEREBY LIMITED TO THE PURCHASE PRICE OF THE PRODUCT AND DESA HEATING PRODUCTS SHALL NOT BE LIABLE FOR ANY OTHER DAMAGES WHATSOEVER INCLUDING INDIRECT, INCIDENTAL OR CONSEQUENTIAL DAMAGES.

Some states do not allow a limitation on how long an implied warranty lasts or an exclusion or limitation of incidental or consequential damages, so the above limitation on implied warranties or exclusion or limitation on damages may not apply to you.

This warranty gives you specific legal rights and you may also have other rights that vary from state to state.

For information about this warranty write:

DESA[™]
HEATING PRODUCTS
2701 Industrial Drive
P.O. Box 90004
Bowling Green, KY 42102-9004
www.desatech.com



107886 01

NOT A UPC

107886-01
Rev. J
08/04

Free Manuals Download Website

<http://myh66.com>

<http://usermanuals.us>

<http://www.somanuals.com>

<http://www.4manuals.cc>

<http://www.manual-lib.com>

<http://www.404manual.com>

<http://www.luxmanual.com>

<http://aubethermostatmanual.com>

Golf course search by state

<http://golfingnear.com>

Email search by domain

<http://emailbydomain.com>

Auto manuals search

<http://auto.somanuals.com>

TV manuals search

<http://tv.somanuals.com>